



## RESISTIVE 4-WAY POWER DIVIDER DC-40GHZ



### Wide Band Power Divider

- Very small package
- Excellent phase and amplitude balance
- Bi-Directional as divider and combiner \*
- Low Insertion loss and high isolation
- Standard: MIL E-5400, MIL E -16400
- High power handling capability

RESISTIVE 4-WAY POWER DIVIDER DC-40GHZ

Electrical Specifications						
Frequency Range (GHz)	Insertion Loss (dB. max)	Isolation (dB. min)	Phase Unbalance (° )	Amplitude Unbalance (dB)	VSWR	Working Temp. Range (° C)
DC~40	2.2	10	±7.0	±2	1.92:1	-20~+55
Average Power (W)	Peak Power (KW)	Reverse Power (W)	Impedance (Ω)	Connector	Port	Storage Temp Range (° C)
0.5 (CW)	N/A	N/A	50	2.4mm	No DC Block	-54 to 125° C

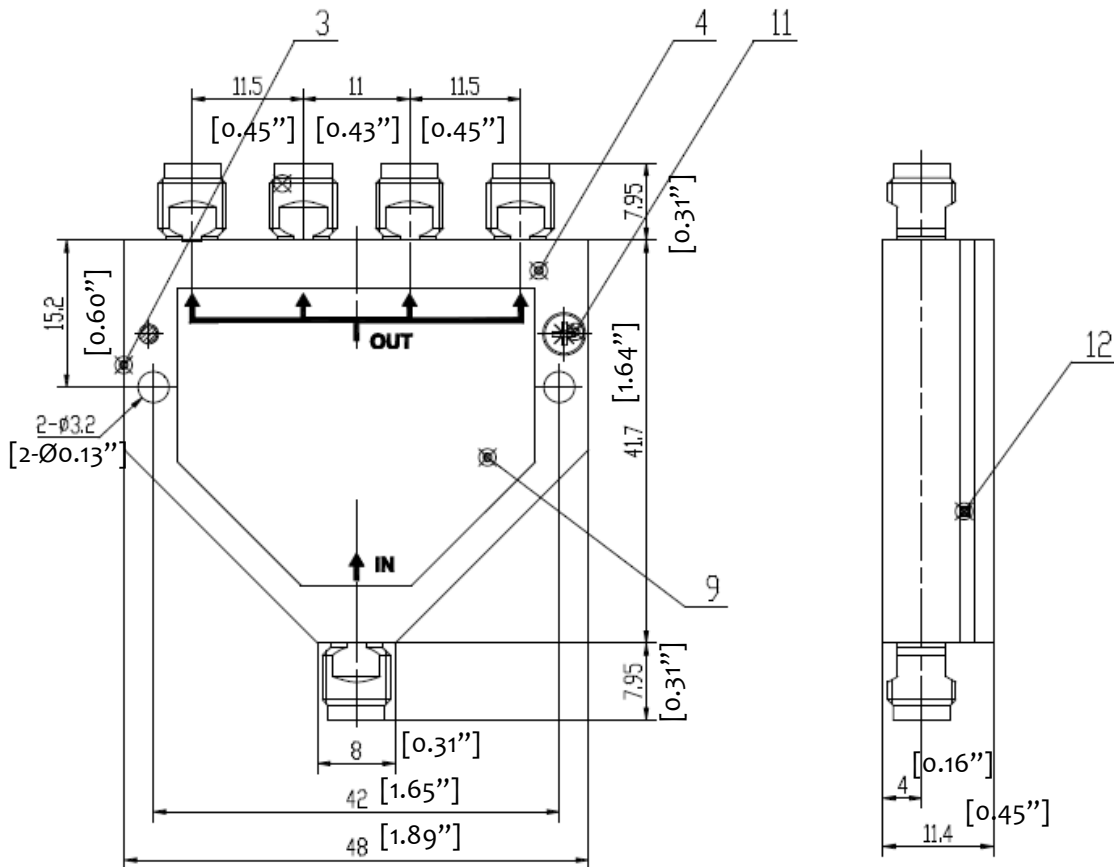



# RF-LAMBDA

The power beyond expectations

## RFLT4WDC40G

RESISTIVE 4-WAY POWER DIVIDER DC-40GHz

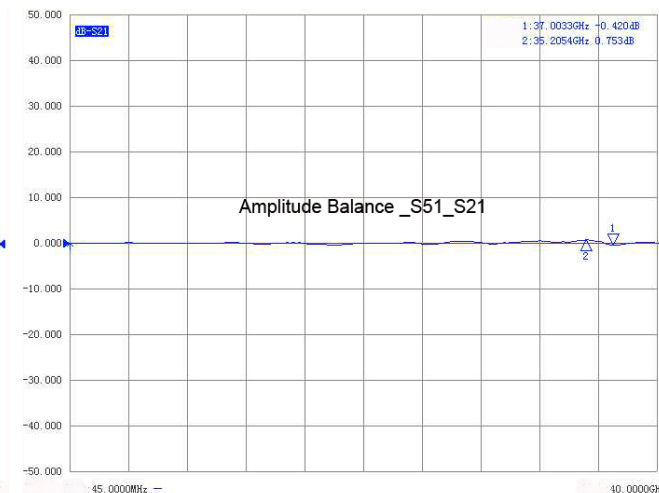
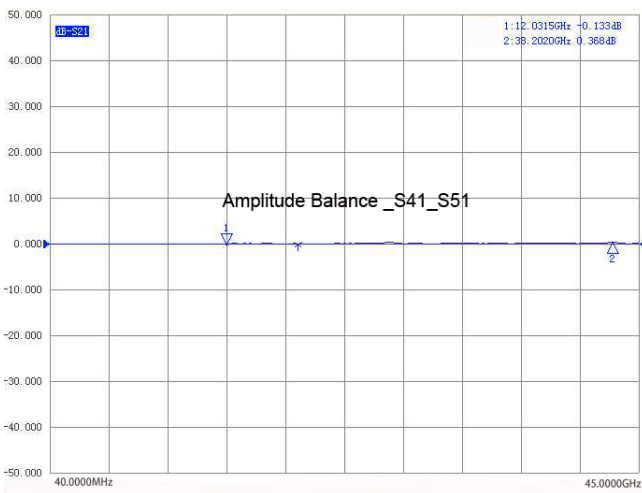
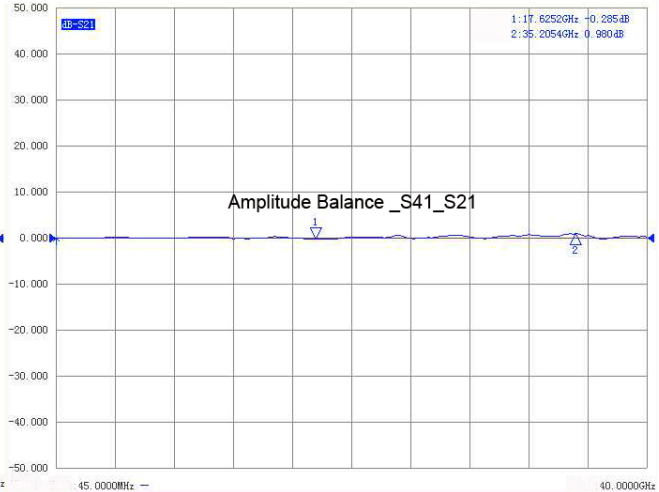
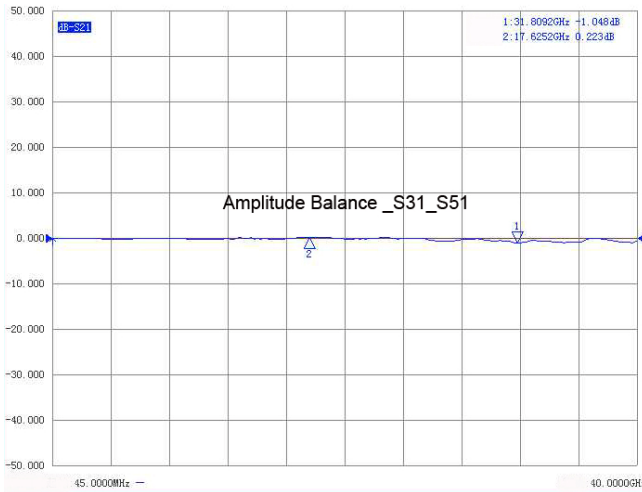
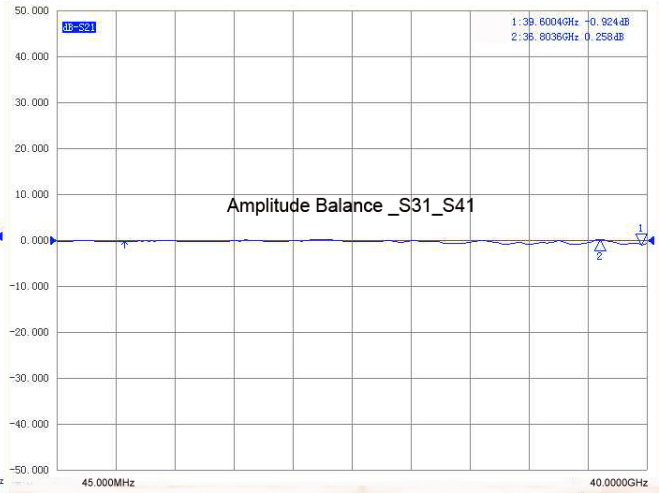
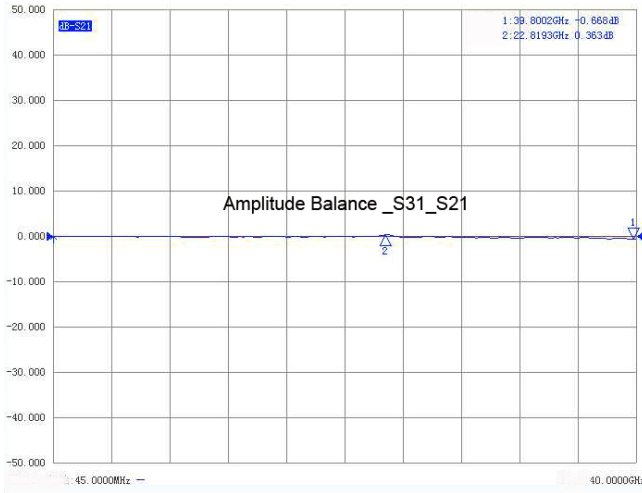



# RF-LAMBDA

The power beyond expectations

RFLT4WDC40G

RESISTIVE 4-WAY POWER DIVIDER DC-40GHz

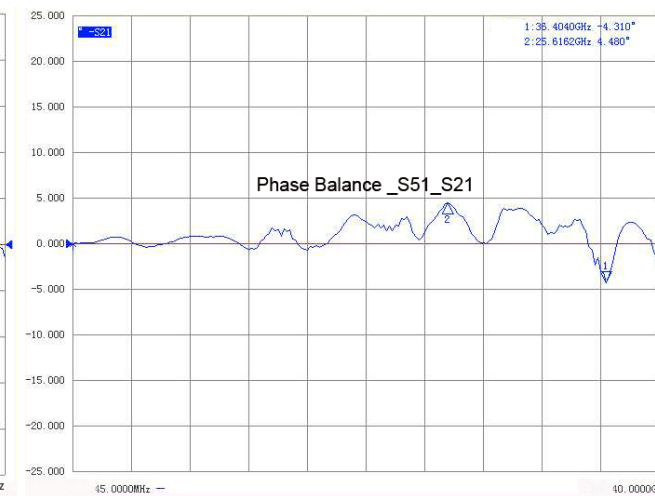
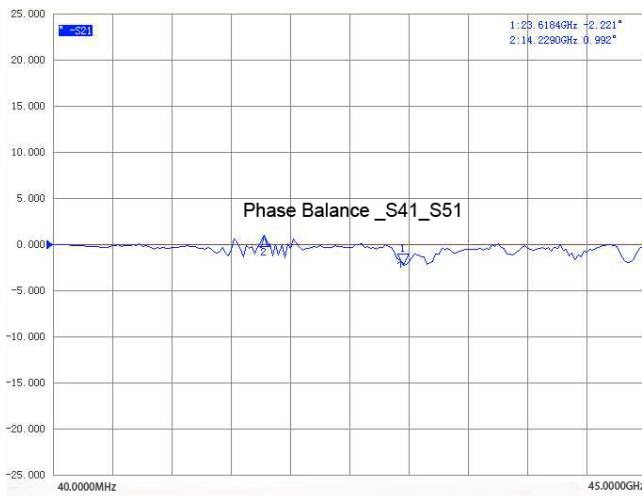
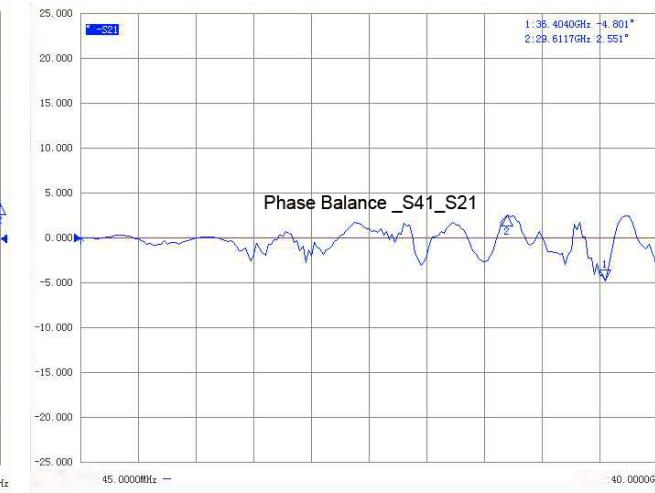
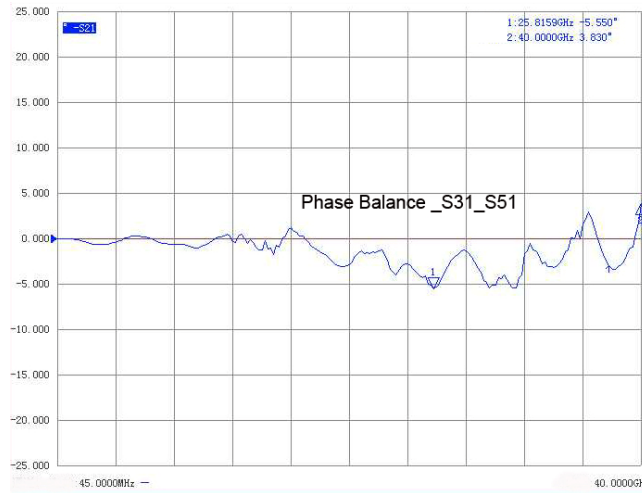
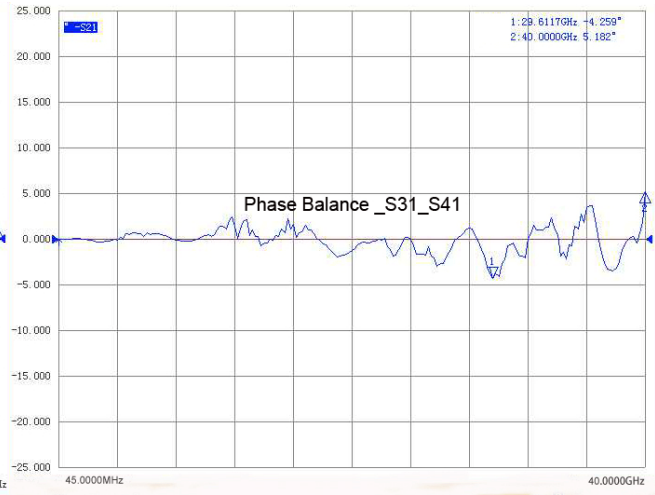
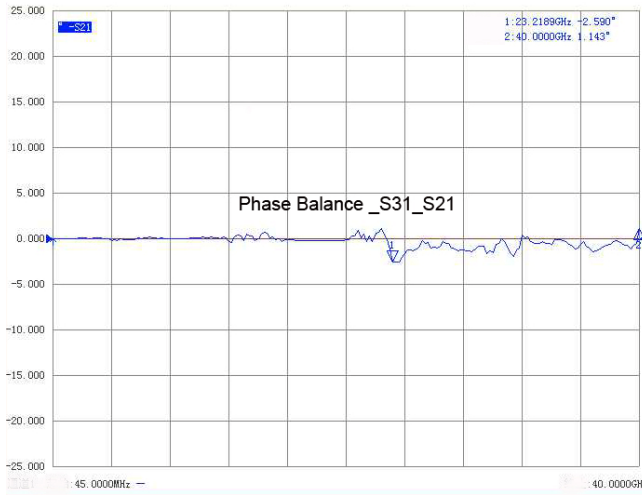



# RF-LAMBDA

The power beyond expectations

RFLT4WDC40G

RESISTIVE 4-WAY POWER DIVIDER DC-40GHz

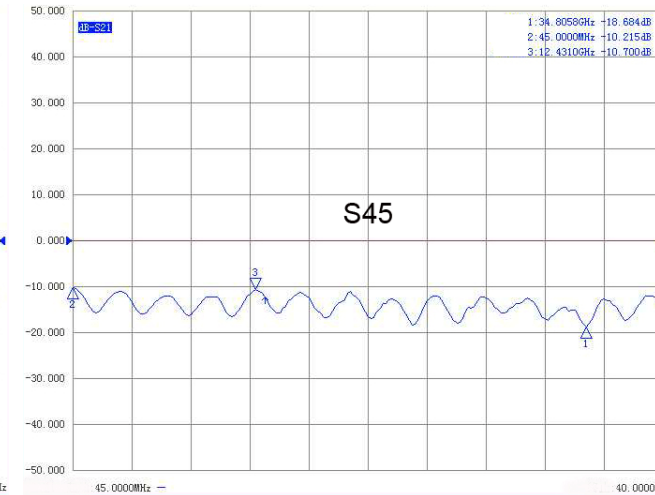
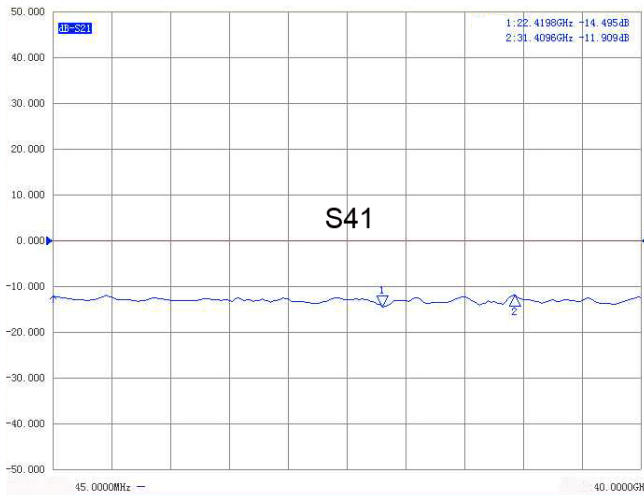
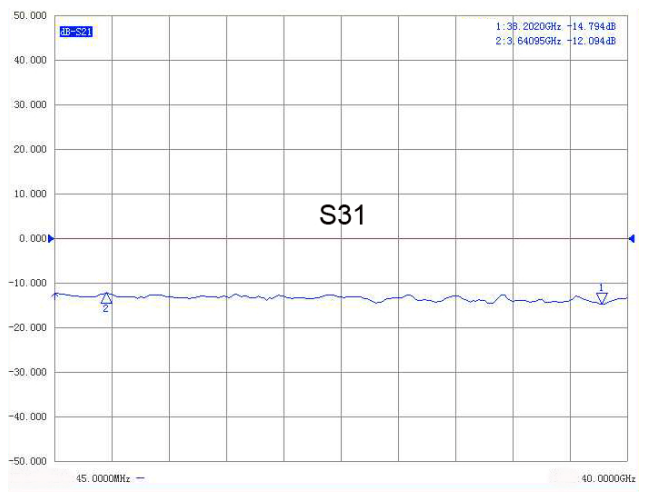
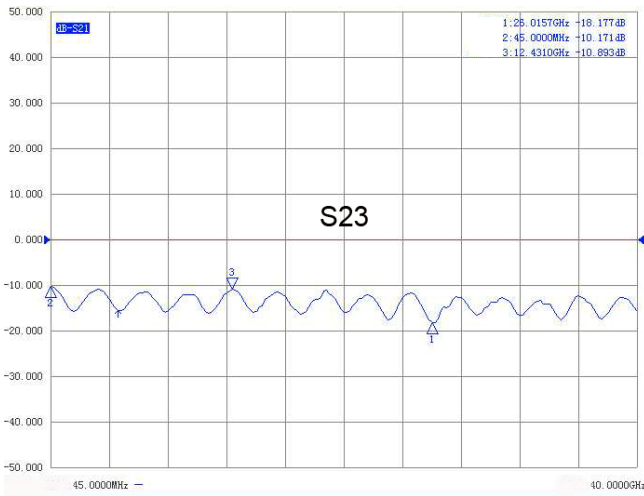
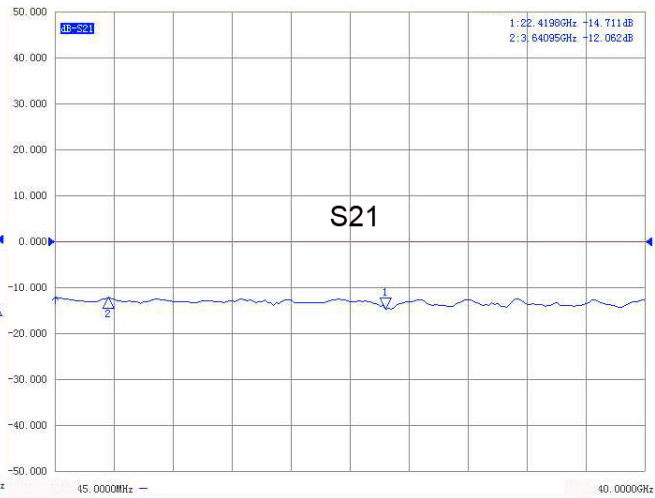
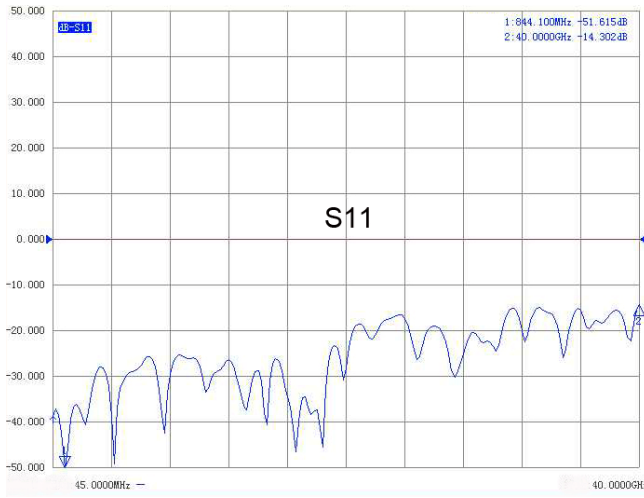



# RF-LAMBDA

The power beyond expectations

RFLT4WDC40G

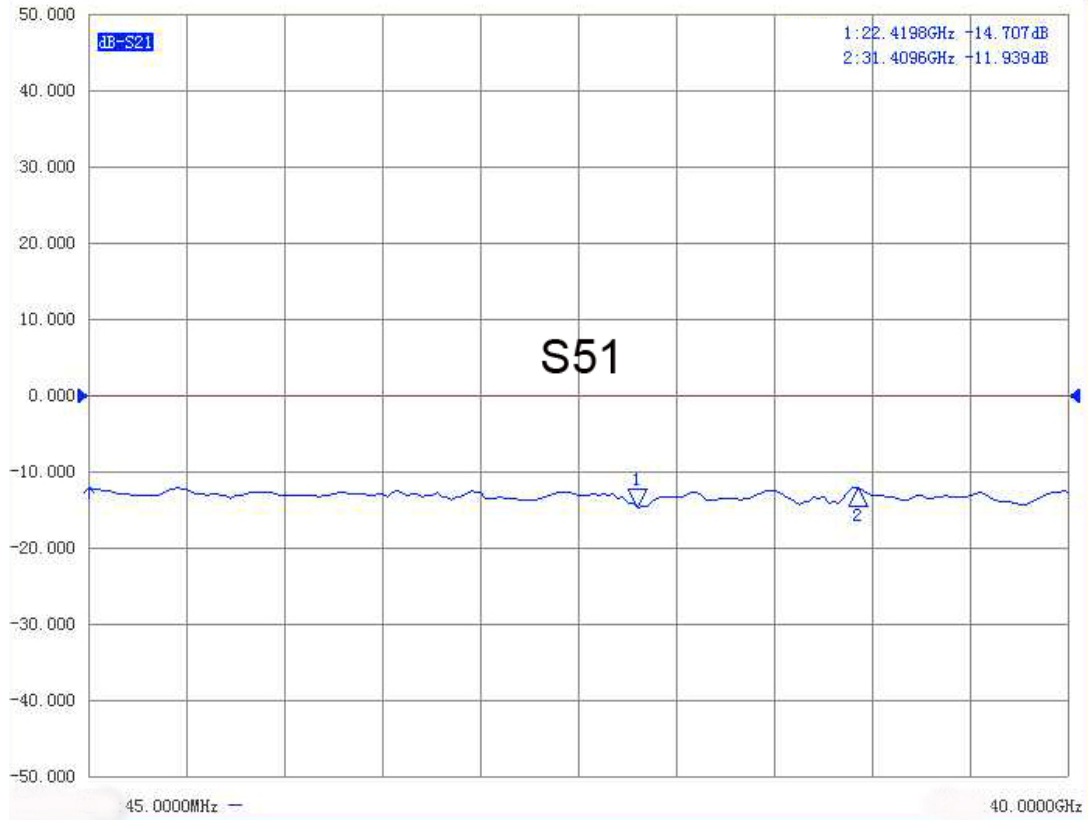

RESISTIVE 4-WAY POWER DIVIDER DC-40GHz



### Amplitude Balance S31-S21

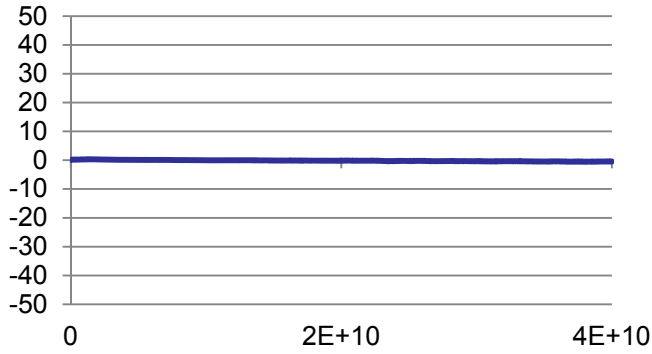

### Amplitude Balance S31-S41

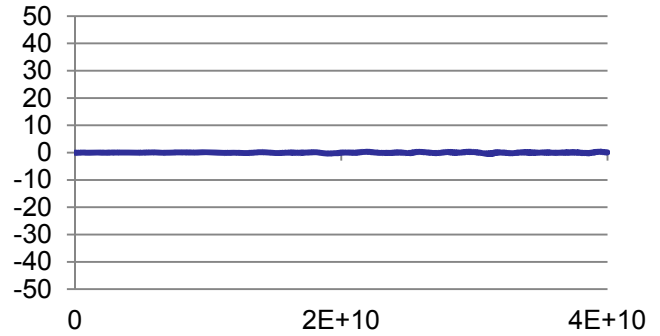

### Amplitude Balance S31-S51

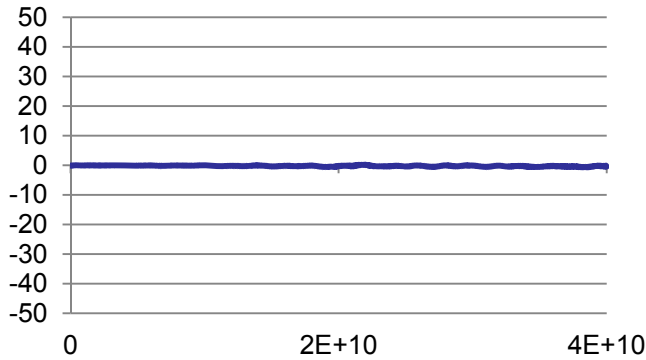

### Amplitude Balance S41-S21

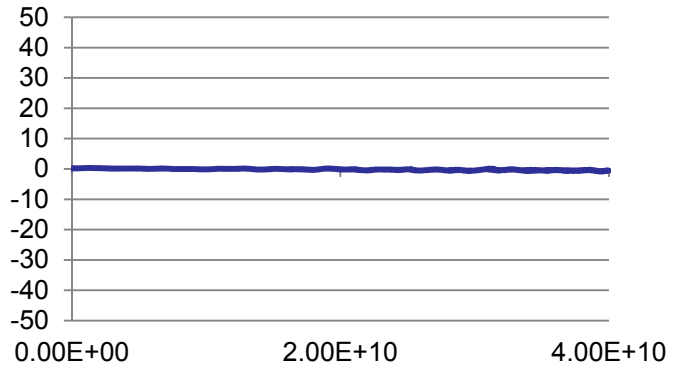

### Amplitude Balance S41-S51

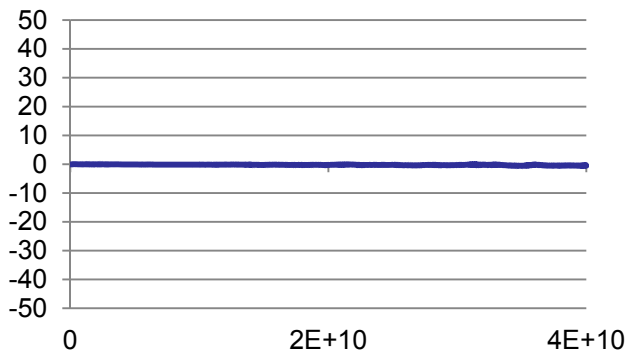

### Amplitude Balance S51-S21

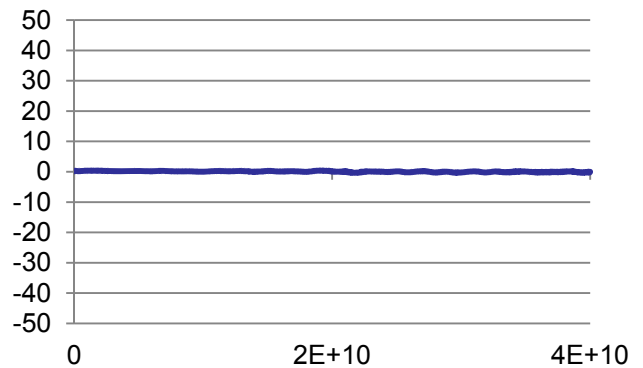



# RF-LAMBDA

The power beyond expectations

RFLT4WDC40G

RESISTIVE 4-WAY POWER DIVIDER DC-40GHZ

Phase Balance S31-S21

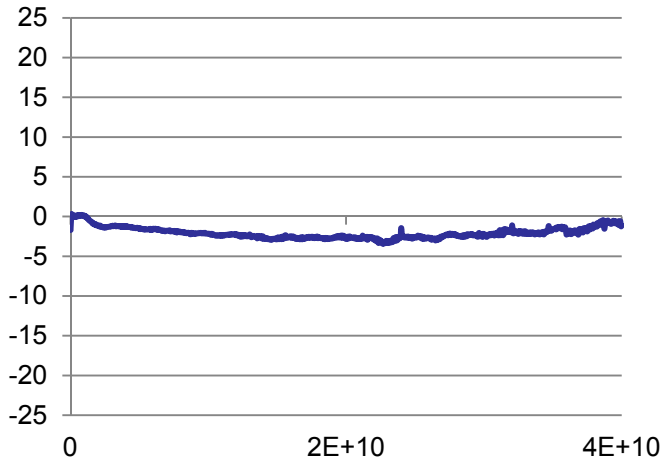

Phase Balance S31-S41

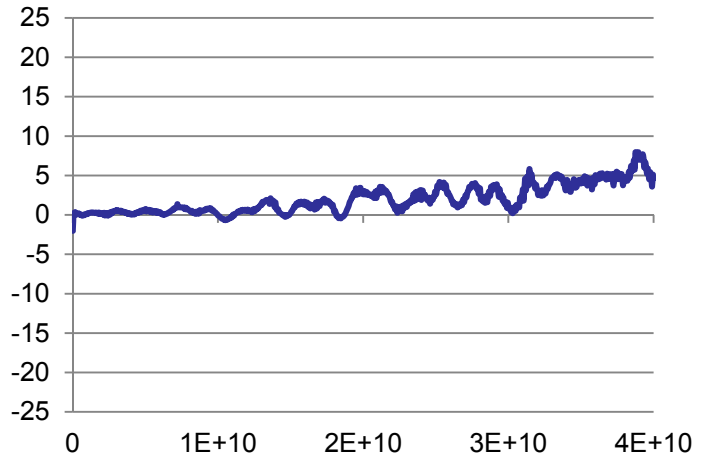

Phase Balance S31-S51

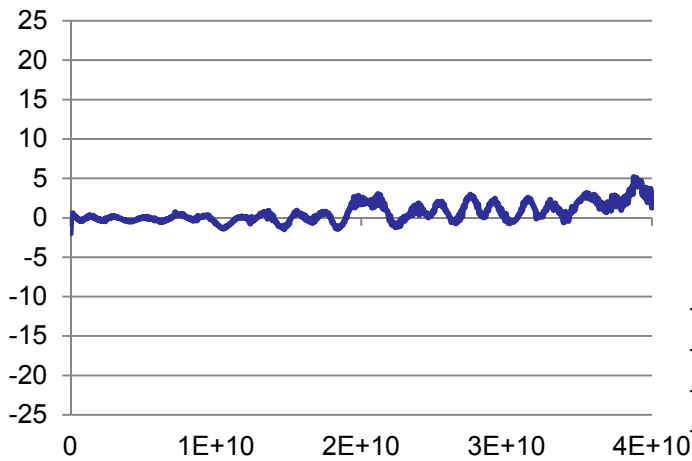

Phase Balance S41-S21

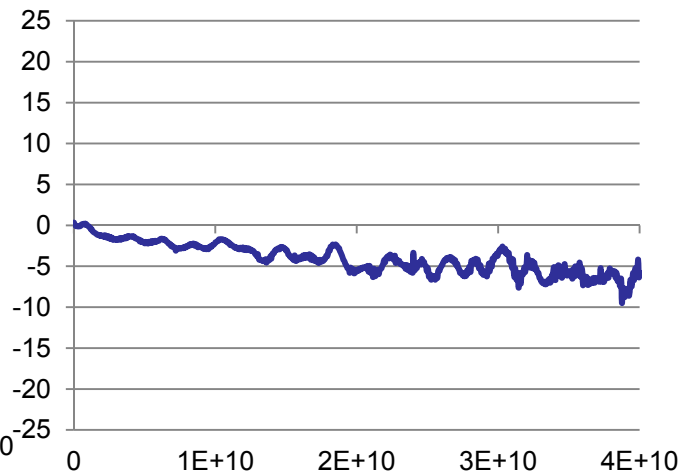

Phase Balance S41-S51

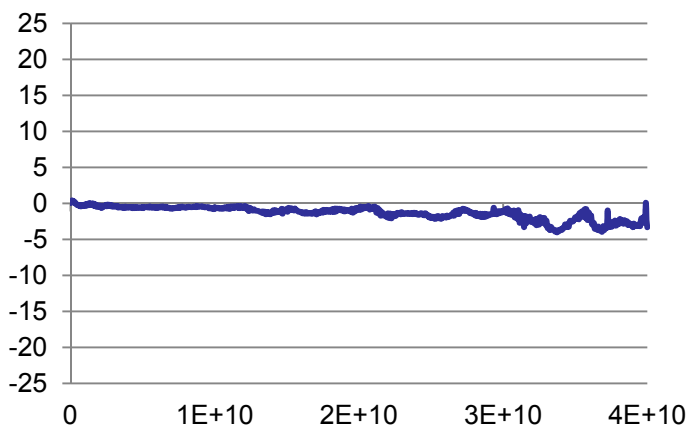

Phase Balance S21-S21

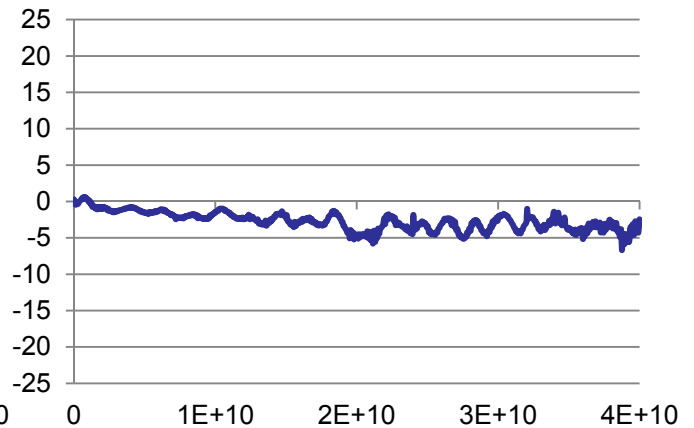



# RF-LAMBDA

The power beyond expectations

RFLT4WDC40G

## S21

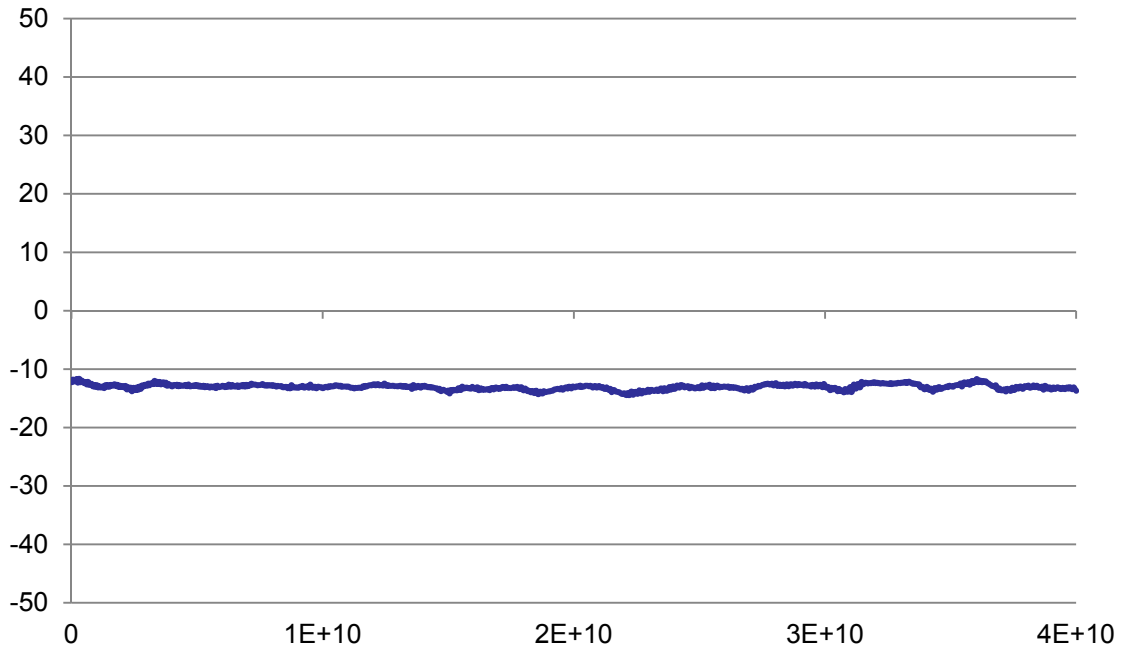

RESISTIVE 4-WAY POWER DIVIDER DC-40GHZ