

USBF TV

USB Connection System for Harsh Environment



Description

USB Field allows you to use a standard USB connection in harsh environments :

- Sealed against fluids and dusts (IP67)
- Shock, Vibration and Traction resistant
- No cabling operation in field and no tools required
- Mechanical Coding / Polarization (2 positions)
- Improved EMI protection

With USB Field, you can insert a **standard USB cordset** into a metallic plug which will protect it from shocks, dust and fluids. No hazardous in-field cabling and grounding !



Transform your USB cordset into a Harsh Environment Connector !

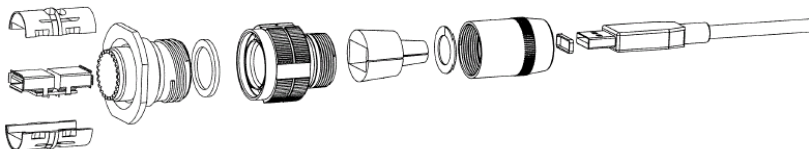

This metallic plug is connected into a receptacle, using a Tri Start Thread coupling mechanism (MIL-DTL-38999 series III type) with anti-decoupling device for high vibrations.

On the receptacle side, one A USB receptacle is soldered onto a PCB allowing for the following back terminations :

- another A USB receptacle
- solder : 4 tined holes on the PCB to solder your wires

The USB cordset shielding is transmitted to the USB receptacle through grounding fingers.

For an outstanding EMI protection, the conductive plated shells (Ni, Cd) with metallized receptacle inserts, transmit the shielding to the connector shells and finally to the panel.

Applications

- Data Acquisition and Transmission in Harsh Environment
- Railways
- Radars
- Shelters
- Battlefield Communication Systems
- Embedded computers
- Navy / Shipboard

DOC-000046-ANG REV A - June 2003 AALBNA

Main Characteristics

Data Transmission

- USB Specification Revision 1.1

Data Rate : 1,5 to 12 Mb/s for Full Speed USB

Mechanical

- Tri Start Thread coupling mechanism (MIL-DTL-38999 series III type) with anti-decoupling device
- 2 mechanical Coding / Polarization possibilities by the user (receptacle insert rotation)
- USBF TV plug retention in the receptacle : 100 N in the axis
- Mating cycles : 500 to 1500
- Sealing (when mated) : IP67 (Temporary immersion)
- Salt Spray : 48 h with Nickel plating > 500 h with Olive Drab Cadmium
- Fire Retardant / Low Smoke : UL94 V0 and NF F 16 101 & 16 102
- Vibrations : 10 – 500 Hz, 10 g, 3 axes : no discontinuity > 1micro s
- Shocks : IK06 : weight of 250 g drop from 40 cm [15.75 in] onto connectors (mated pair)
- Humidity : 21 days, 43°C, 98% humidity
- Temperature Range : - 55°C / +85°C

Can be used with most of the USB cordset Brands : No tools required

Assembly Instructions

Plug Assembly

1. Only if you need a full sealing (IP67) : Install the white sticker around the plug, covering the 4 little holes of the overmolding
2. Insert the black O Ring around the front face of the USB A plug. This O Ring will ensure the connection sealing.
3. Insert the USB cordset into the metallic backshell
4. Insert laterally to the cable the retention spacer (this spacer is soft, in order to adapt to different shapes of overmolding) and slide the overmolding of the USB-A plug into this retention spacer
5. Insert laterally to the cable the friction ring
6. Choose the right coding (2 positions) and insert the USB-A plug into the protective plug. The reference is the main key.
7. Screw the backshell on the plug body. A spanner can be necessary to fully screw it, and the connection to the receptacle can help.

Important Note : The connection sealing is not done by the black retention spacer (which is slotted), but by the front face O Ring (see 2.)

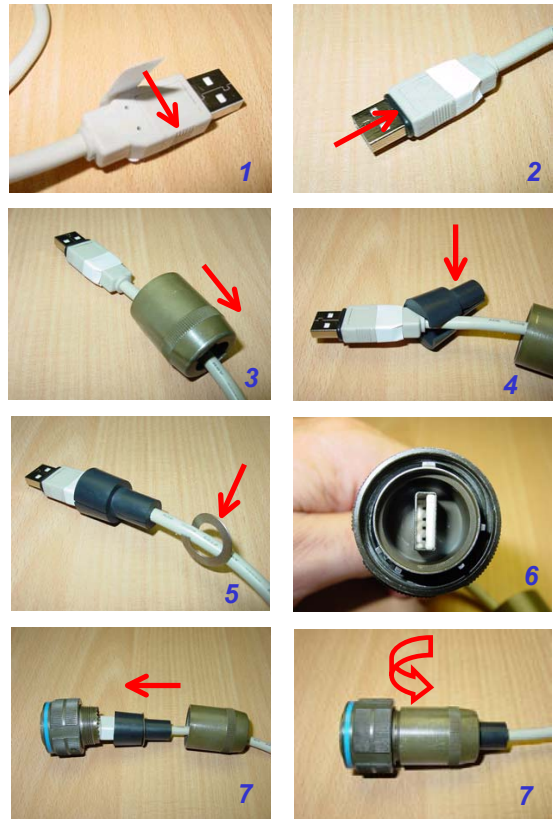

Receptacle Assembly

Insert the USB module **from the rear**. The reference is the main key. Be aware to have a coding compatible with the coding you used for the plug : on front view, the **white shapes** in the USBs **must be on the same side**.

To remove the USB module, insert the removal tool USBF ODE from the Front, and push back the module.



Plug

Shell type 6
With Plastic or Metal Gland

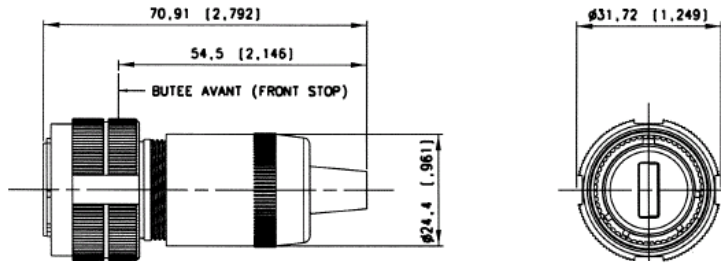

Receptacle

Square flange receptacle
4 mounting holes
Shell type 2

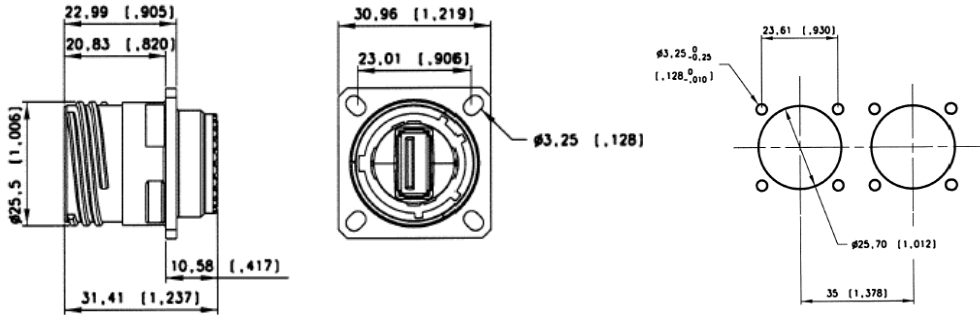

Jam Nut
Receptacle
Shell type 7

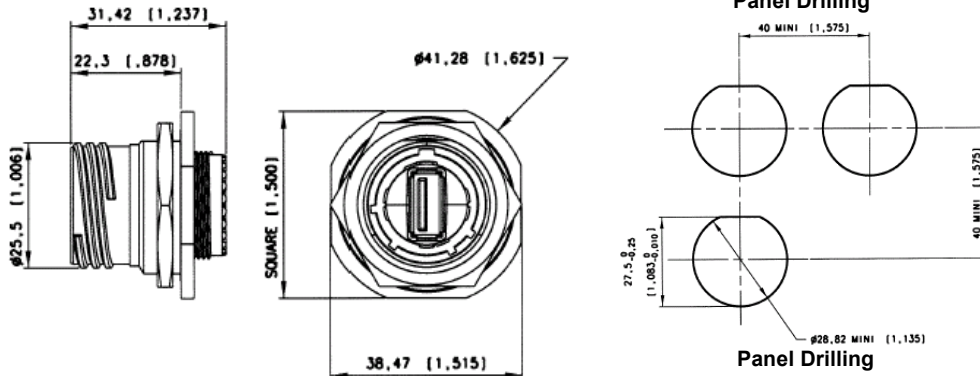

Shells 2PE and 7PE
with Backshell to protect
Backtermination from
dust, shocks and
vibration. Not sealed.

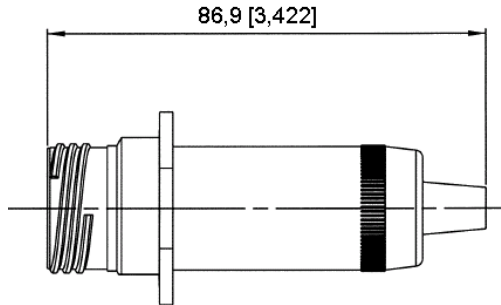

Back Termination

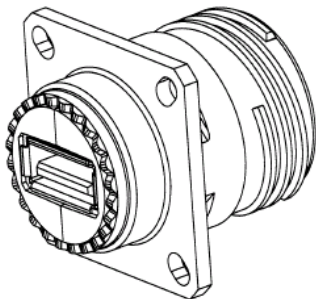

Type 1 : USB-A Receptacle

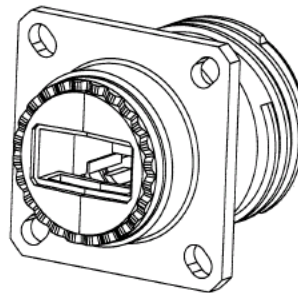

Type 2 : Solder

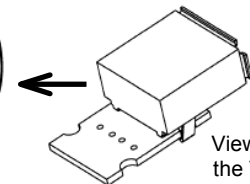

View of the PCB of the Type 2 version with 4 tinned holes for solder termination

4 Tinned holes to solder your cable

Part Number Code

HOW TO ORDER

USBF TV	2	1	G
USB Field TV			
Shell Type			
6 : Plug			
2 : Square Flange Receptacle			
2PE : Square Flange Receptacle with backshell			
7 : Jam Nut Receptacle			
7PE : Jam Nut Receptacle with backshell			
Back Terminations (Receptacles only)			
1 : USB-A receptacle			
2 : Solder (4 tined holes)			
Shells Plating			
N : Nickel			
G : Olive Drab Cadmium			

- Examples :
- Olive Drab Cadmium Plug : **USBF TV 6G**
 - Olive Drab Cadmium Square Flange Receptacle, USB-A back termination : **USBF TV 21G**
 - Olive Drab Cadmium Jam Nut Receptacle, USB-A receptacle back termination : **USBF TV 71G**
 - Nickel Jam Nut Receptacle, solder termination : **USBF TV 72N**

Accessories

• Metallic Caps

USBF TVC	2	G
Connector Type		
6 : Plug		
2 : Square Flange Receptacle		
7 : Jam Nut Receptacle		
Protection de surface		
N : Nickel		
G : Olive Drab Cadmium		

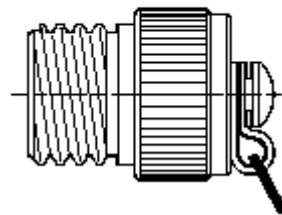

Plug Cap

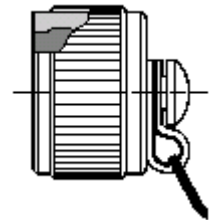

Receptacle Cap

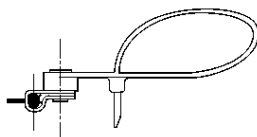

Plug Cap end

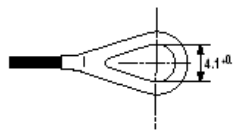

Square flange receptacle cap end

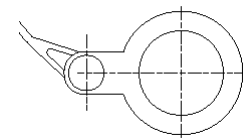

Jam Nut receptacle cap end

- Panel Gasket for square flange receptacle (Thickness : 0,8 mm [.031]) : JE15

- Receptacle Insert removal tool : USBF ODE

