

MTRJ FIELD TV

Sistema di connessioni Ethernet per Ambiente «ostile»

Il MTRJ field offre un sistema semplice per far evolvere un MTRJ standard in un MTRJ ambientale.

- Tenuta ai fluidi e alle polveri (IP67)
- Resistente a urti e vibrazioni
- Non sono necessari utensili per il cablaggio e l'installazione

Con il sistema brevettato RJStop® potrete utilizzare i cordini di connessione MTRJ standard nelle spine metalliche per proteggerli dagli urti, dai fluidi e dalle polveri.

Niente cablaggio su pavimentazioni irregolari

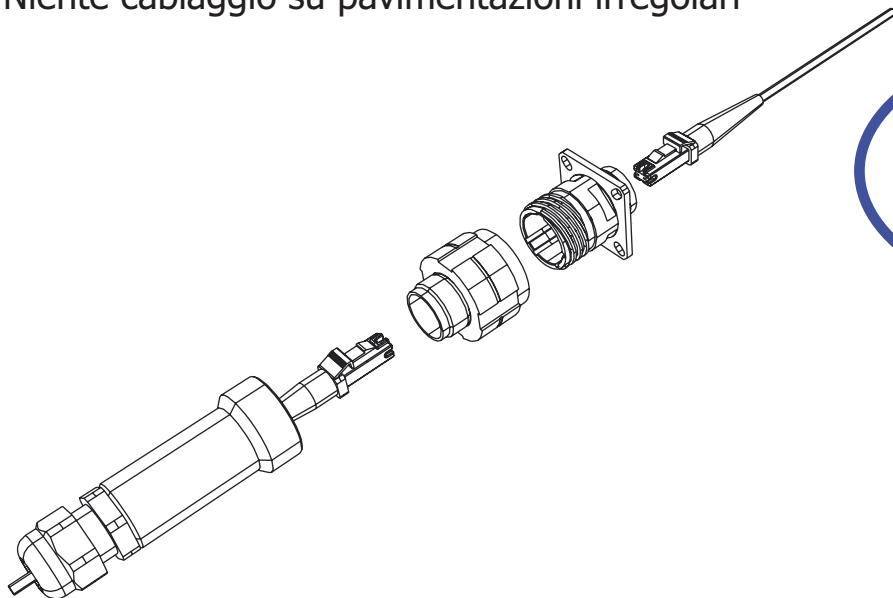

Trasformare la propria connessione MTRJ in connessione ambientale

Questa spina metallica è connessa a un supporto che utilizza un meccanismo di chiusura a vite Tri Start (tipo MIL-DTL-38999 serie III) con un sistema antisganciamento per forti vibrazioni.

Prestazioni ottiche:

- numero di vie: 1/2/4
- perdita d'inserzione tipica: 0,5 db in Multimode
- durata 500 cicli accoppiamento/disaccoppiamento (variazione < 0,2 db)

Acquisizione dati e trasmissione in ambienti difficili

- ferrovie
- radar
- postazione militare
- sistemi di comunicazione su campo di battaglia
- navale

Applicazioni

Amphenol
Socapex Fibre Optic Business Division

MTRJ FIELD TV



Schema descrittivo

- Spina (MIL DTL 38 999 serie III Dimensione 13)

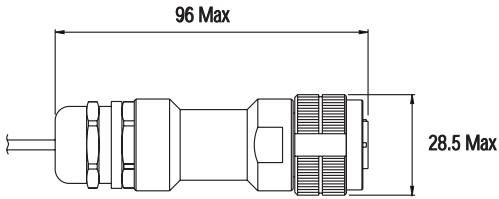

- Supporto quadrato (MIL DTL 38 999 serie III Dimensione 13)

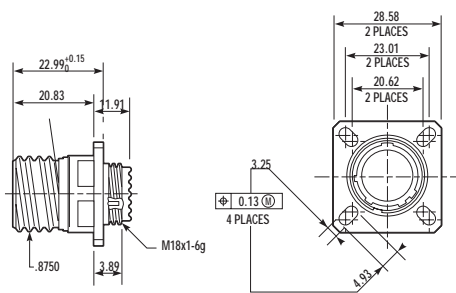

Foratura pannello

Supporto quadrato
montaggio anteriore

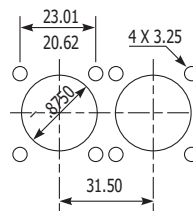

Supporto quadrato
montaggio posteriore

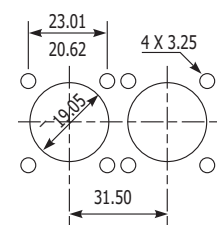

- Supporto rotondo (MIL DTL 38 999 serie III Dimensione 13)

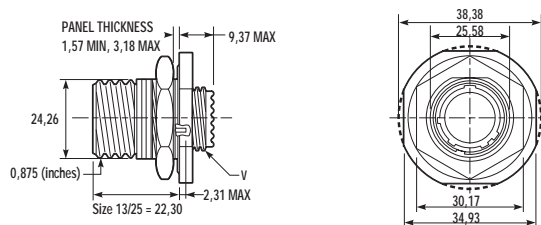

Foratura pannello
Supporto rotondo
Montaggio posteriore

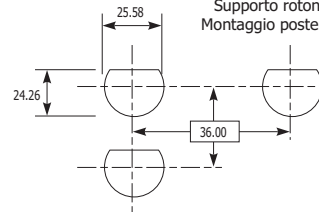

- Supporto con Spina (MIL DTL 38 999 serie III Dimensione 13)

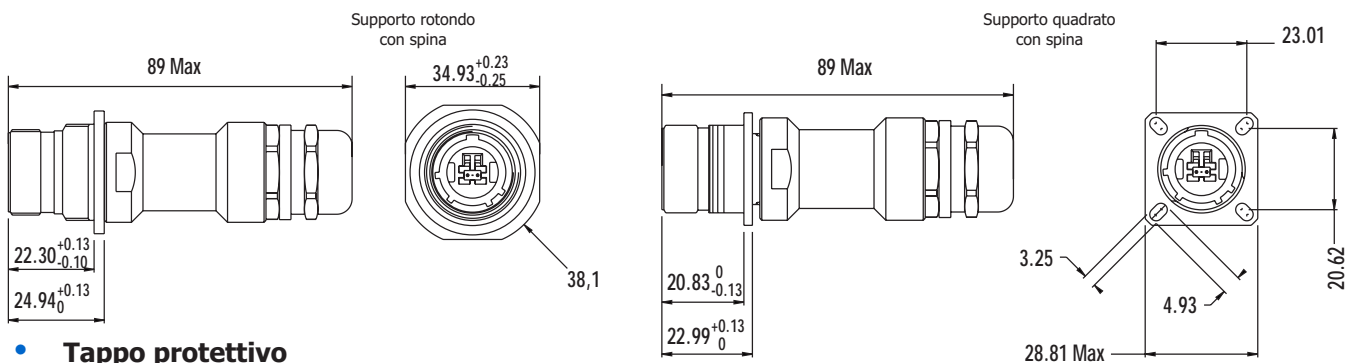

- Tappo protettivo

Tappo protettivo per spina
(cordino di nylon)

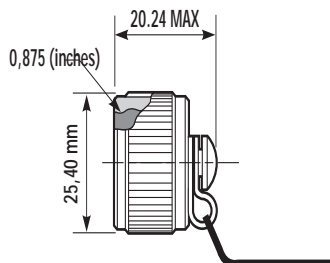

Tappo protettivo per supporto
(cordino di nylon)

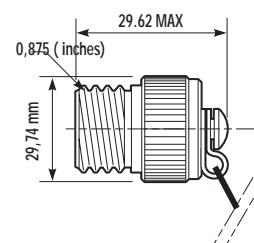

MTRJ FIELD TV



- **MTRJ FIELD Informazioni per ordinare**

Série :	MTRJF TV	6M	C	G	N
MTRJ Field TV					
Tipo di scatola elettrica					
6	: Spina con raccordo in metallo, PG in plastica				
6M	: Spina con raccordo e PG in metallo				
2	: Supporto fissato con 4 viti				
2PE	: Fissaggio a 4 viti, raccordo in metallo e PG in plastica				
2PEM	: Fissaggio a 4 viti, raccordo e PG in metallo				
7	: Supporto fissato con dado esagonale				
7PE	: Fissaggio con dado, raccordo in metallo e PG in plastica				
7PEM	: Fissaggio con dado, raccordo e PG in metallo				
Tipo di cavo					
C	: Cavo rotondo duplex 2,8 mm				
D	: Cavo piatto duplex 1,6 mm				
S	: Cavo zipcord duplex 1,6 mm				
0	: Supporto senza raccordo				
T	: Cavo rotondo duplex 2,8 mm / cavo piatto duplex 1,6 mm / cavo zipcord duplex 1,6 mm				
Protezione delle scatole elettriche					
N	: Nickel				
G	: Cadmio verde oliva				
B	: Bronzo				
Codifica delle chiavi					
N	: Normale				
A / B / C / D / E					

- **TAPPO DI PROTEZIONE Informazioni per ordinare**

Serie tappo	B	EC	N	TV	W	13
Tappo protettivo						
EC	: per supporto quadrato					
ER	: per supporto rotondo					
F	: per spina					
Tipo di bloccaggio						
N	: cordino di nylon					
Bianco	: catena metallica					
TV						
Tipo di finitura						
B	: Bronzo					
F	: Placcato nickel su corpo in alluminio					
W	: Finitura verde oliva su corpo in alluminio					
Dimensione del connettore corrispondente						
13						

- **Informazioni necessarie per ordinare i cordoni connessione per MTRJ FIELD**

Spina MTRJ	: maschio/femmina
Tipo di fibra	: 50/125, 62,5/125, 9/125
Lunghezza dei cordoni	: da 10,5 m
Disegno	: descrizione del prodotto

Contattateci per altre configurazioni

- **Attrezzo dismontaggio**

MTRJFTV DM TOOL

Amphenol, your Worldwide Interconnect Partner !

50 manufacturing and assembly operations on 5 continents
Sales, marketing and distribution organizations in 60 countries

Amphenol Corporation is one of the world's leading producers of electronic and fiber optic connectors, cable and interconnect systems.

Our company's focus is on producing connecting devices for the converging technologies of voice, video and data transmission, for wired and wireless internet and broadband networks, as well as industrial, automotive and aerospace industries.

Fiber Optic Operations

EUROPE

AMPHENOL EASTERN EUROPE
Sanatorium Strasse 19-16-1 - 1140 Vienna
Austria
Telephone: 43-19-85-15-11
Fax: 43-19-82-61-01

AMPHENOL AIR LB France
11 avenue Dubonnet
92407 Courbevoie Cedex
France
Telephone: 33-1-4905-3000
Fax: 33-1-4905-3010

**AMPHENOL SOCAPEX
MIL-AERO & INDUSTRIAL Business Unit**
948 Promenade de l'Arve - B. P. 29
74311 Theyez Cedex
France
Telephone: 33-4-5089-2800
Fax: 33-4-5096-1941

AMPHENOL AIR LB GmbH
Am Kleinbahnhof 4 - 66740 Saarlouis
Germany
Telephone: 49-6831-981-00
Fax: 49-6831-981-030

AMPHENOL ITALIA
Via Barbaiana 5, 20020 Lainate - Milano
Italy
Telephone: 39-02-932-54-209
Fax: 39-02-932-54-444

AMPHENOL IBERICA
Edificio "Burgosol" oficina n55
C/Comunidad de Madrid, 35-bis - 28230 Las Rozas
Spain
Telephone: 34-91-640-7302
Fax: 34-91-640-7307

AMPHENOL SCANDINA
Box 2047, JohannelsundsVägen 2
194 02 Upplands Väsby
Sweden
Telephone: 46-8-594-10440
Fax: 46-8-590-33800

AMPHENOL BENELUX
Hoofdveste 19 - 3992 DH Houten
The Netherlands
Telephone: 31-17-244-4903
Fax: 31-17-224-0254

**AMPHENOL EUROPEAN
SALES OPERATIONS**
Hoofdveste 19 - 3992 DH Houten
The Netherlands
Telephone: 31-30-635-8000
Fax: 31-30-637-7034

AMPHENOL LIMITED WHITSTABLE
Thanet Way, Whitstable - Kent, CT5 3JF
United Kingdom
Telephone: 44-1227-773-200
Fax: 44-1227-276-571

AMPHENOL LIMITED NOTTINGHAM
Unit D1 Crossgate Drive, Queens Drive Industrial
Estate - NG2 1LW - Nottingham
United Kingdom
Telephone: 44-1159-866-200
Fax: 44-1159-866-212

AMERICAS

**AMPHENOL AEROSPACE OPERATIONS
AMPHENOL INDUSTRIAL OPERATIONS**
40-60 Delaware Street
Sidney, New York 13838-1395
USA
Telephone: 1-607-563-5011
Fax: 1-607-563-5157

AMPHENOL BACKPLANE SYSTEMS
18 Celina Avenue
Nashua, New Hampshire 03063
USA
Telephone: 1-603-883-5100
Fax: 1-603-883-0171

AMPHENOL FIBER OPTIC PRODUCTS
1925A Ohio Street
Lisle, Illinois 60532
USA
Telephone: 630-960-1010
Fax: 630-810-5640

AMPHENOL CANADA CORPORATION
20 Melford Drive - Scarborough, Ontario M1B 2X6
Canada
Telephone: 1-416-291-4401
Fax: 1-416-292-0647

1870 boul. des Sources, Suite 204
Pointe Claire, Quebec H9R 5N4
Canada
Telephone: 1-514-630-7242 ext. 225
Fax: 1-514-630-7697

**AMPHENOL AIR LB
NORTH AMERICAN OPERATIONS**
295 Kesmark, Dollard-des-Ormeaux Quebec H9B 3J1
Canada
Telephone: 1-514-421-2153
Fax: 1-514-421-3408

R.O.W.

AMPHENOL ARGENTINA
Av. Callao 930 2do piso Oficina B "Plaza" - C1023
AAP - Buenos Aires
Argentina
Telephone: 54-11-4815-6886
Fax: 54-11-4814-5779

**TFC SOUTH AMERICA
BUENOS AIRES, ARGENTINA**
Local Sales Office - Tucuman 540
Suite 28 "C"
C1049AAL - Buenos Aires
Argentina
Telephone: 54-11-4325-3471
Fax: 54-11-4327-1339

AMPHENOL AUSTRALIA PTY LIMITED
2 Fiveways Blvd., Keysborough
Melbourne, Victoria 3173
Australia
Telephone: 61-3-8796-8888
Fax: 61-3-8796-8801

AMPHENOL DO BRAZIL
Rua Diogo Moreira, 132-20j andar
CEP: 05423-010 D Sao Paulo-SP
Brazil
Telephone: 55-11-3815-1003
Fax: 55-11-3815-1629

CHINA (FOP)
3rd Floor, The 4th Ind. District of Ind. Headquarters -
Dong Keng Road,
Gong Ming Town
Shenzhen 518132, Guangdong Province
PR China
Telephone: 86-755-717-7945
Fax: 86-755-717-7622

AMPHENOL EAST ASIA LIMITED
2201 Railway Plaza, 39 Chatham Road South
Tsmishatsui, Kowloon
Hong Kong
Telephone: 852-2699-2663
Fax: 852-2691-1774

AMPHENOL INDIA
105 Bhosari Industrial Area - Pune 411 026
India
Telephone: 91-20-712-0363/712-0463/712-0155
Fax: 91-20-712-0581

BAR TEC LTD
4 Hagavish St., PO Box 279 - Kfar Saba 44102
Israel
Telephone: 972-9-767-4097
Fax: 972-9-767-4324

AMPHENOL JAPAN MILAERO INDUSTRIAL
689-1, Aza Nogami, Iseochi Ritto-cho
Shiga 520-3044
Japan
Telephone: 81-77-553-8501
Fax: 81-77-551-2200

AMPHENOL DAESHIN
558 SongNea
Sosa, Bucheon, Kyunggi 422-040
Korea
Telephone: 82-32-610-3800
Fax: 82-32-673-2507

AMPHENOL MEXICO
Piso 2 - CP 11560
Mexico
Telephone: 52-5-254-7283
Fax: 52-5-531-9659

AMPHENOL SOUTH AFRICA
Sandown Village
East Court, 1 Gwen Lane Corner Maude Street
Sandton 2146
South Africa
Telephone: 27-11-305-9574
Fax: 27-11-305-9576

AMPHENOL TAIWAN CORPORATION
No. 116, Lane 956, Zhong Shan Road
Taoyuan City, R. O. C., 330
Taiwan
Telephone: 886-3-379-5677
Fax: 886-3-360-7259 Sales/CS/Eng/QA/MIS

GESTAS
34630, Besyoi D Londra Asfalti
Florya is Merkezi
Kat. 2 - Sefakoy / Istanbul
Turkey
Telephone: 90-212-624-52-29
Fax: 90-212-599-30-68