

Revision 1.1

User's Manual GW-uni2 plus

Universal gang programmer



WWW.SEMINIX.COM

Important Notice

The information in this publication has been carefully checked and believed to be entirely accurate at the time of publication. SEMINIX assumes no responsibility, however, for possible errors or omissions, or for any consequences resulting from the use of the information contained herein. SEMINIX, continues to improve products and upgrade specification, and firmware at any time without notice.

SEMINIX reserves the right to make changes in its products or product specifications with the intent to improve function or design at any time and without notice and is not required to update this documentation to reflect such changes.

SEMINIX makes no warranty, representation, or guarantee regarding the suitability of its products for any particular purpose, nor does SEMINIX assume any reliability arising out of the application or use of any product or circuit and specifically disclaims any and all liability, including without limitation any consequential or incidental damages.

© 2011 SEMINIX Co., Ltd.

This publication contains proprietary information, which is protected by copyrights. All rights are reserved. No part of this publication may be photocopied, reproduced, transmitted in any form or translated to another language by means, electric or mechanical, by photocopying, recording, or otherwise, without the prior written consent of SEMINIX Co., Ltd.

Seminix Co., Ltd.

204-ho, 2ndFl. Leader's Building, #342-1

Yatap-dong, Bundang-Gu, Seongnam-si, Gyeonggi-do
Korea (463-828)

Web Address : <http://www.seminix.com>

E-mail: sales@seminix.com

Tel + 82-31-703-7891 Fax : + 82-31-702-7869

Table of Contents

1. Overview

1.1 Features and Specifications	1
1.2 Packing Includes	2

2. Setup

2.1 Host system requirement	3
2.2 To install PC application program.....	3
2.3 To install USB driver	3
2.4 GW-uni2 plus Configuration	3

3. PC Application Program

3.1 PC application program	4
3.2 Hardware setup	4
3.3 USB connection	5
3.4 Device selection	6
3.5 File open	8
3.6 Program option	10
3.7 System Power(VDD), Program Power(VPP)	12
3.8 Program count	13
3.9 Data download	15
3.10 Program	16
3.11 Verify	16
3.12 Chip erase	17
3.13 Blank check	17
3.14 Device checksum	18
3.15 Buffer checksum	18
3.16 Dump	19
3.17 Read Buffer	20
3.18 Key Lock	21
3.19 Password Change	24
3.20 Socket state	26
3.21 State window	27
3.22 GW-uni2 plus Setting window	27
3.23 Upgrade	28

4. Stand-alone mode	
4.1 System on and initialization -----	29
4.2 LCD display information -----	29
4.3 Program mode -----	30
4.4 Verification mode -----	31
4.5 Erase mode -----	32
4.6 Blank check mode -----	33
4.7 Device checksum mode -----	34
4.8 Buffer checksum mode -----	35
4.9 Menu mode -----	36
4.11 Program option -----	37
4.12 Program count -----	37
4.13 Beep sound -----	37
4.14 Read Device -----	38
4.15 Information -----	39
4.16 Return -----	39
4.17 Result -----	40
4.18 Socket LED -----	40
4.19 Socket Life Time -----	41
5. Operation Sequence -----	42
6. Key Function Map -----	43
7. On-Board Program -----	44
8. Electrical Characteristics -----	47
9. Special Notice -----	47
10. Adapter Socket Table -----	48

1. Overview

GW-uni2 plus is the gang programmer for all SAMSUNG MCU and Fujitsu MCU with standard serial writing. The Gang programmer consists of a master unit (GW-uni2 plus) which connects to various programming adapter sockets for programming all devices with a different package.

This gang programmer can program 8 devices with very fast programming speed once. It is good for mass production. A data is saved in GW-uni2 plus memory by PC so it works without PC (Stand-alone mode). User can easily set a device information by a device part number selection.

1.1 Features and Specifications

- 1) Support all SAMSUNG MCUs with Standard Serial Writing.
- 2) Internal Memory: 100Mbyte
- 3) GW-uni2 plus setup and initialize with PC application program.
- 4) Stand-alone operation mode without PC.
(GW-uni2 plus should be setup by PC application program for the stand-alone mode in advance)
- 5) Program maximum 8 devices once.
- 6) Display a current state and a working state by LCD
- 7) Device selection can be set by a device part number.
- 8) Program : Data programming to a device.
 - Other functions can be worked with program option
- 9) Program Option
 - Auto Chip Erase : Erase before program.
 - Auto Verification : Verify after program
 - Read Protection : A device ROM data can't be read
 - SMART Option
- 10) Erase : Erase a device ROM data.
- 11) Verify : Compare a buffer memory data to a device data
- 12) Blank check: Check a device ROM data initialized (0xFF)
- 13) Device Checksum : Display a checksum of a device in the first socket.
- 14) Buffer Checksum : Display a checksum of GW-uni2 plus buffer memory data.
- 15) Dump : Display a device ROM data or a buffer memory data.
- 16) Read buffer : Save a buffer memory data as a PC file.(Intel hex format).
- 17) Read device : Save a device ROM data in buffer memory.
- 18) Program counter : Display the number of programmed device.
- 19) Key Lock : Restrict functions in stand-alone mode.
- 20) Password Change : Change a password
- 21) GW-uni2 plus setting information: Display GW-uni2 plus setting information
- 22) Socket State : Display each socket state

- 23) User can use the latest software with a simple upgrade.
- 24) Data download speed: 860Kbps (MAX)
- 25) Program speed(average)
Samsung : OTP = 2KB/S, MTP = 10KB/S
- 26) Power : 19VDC 500mA power adapter (110/220VAC[60HZ])
- 27) Operating system: Windows XP / Windows 7
- 28) Support Intel hex format, SAMSUNG hex format, Binary format.
- 29) Size: 350mm x 220mm x 35mm Weight: 1.4kg

1.2 Packing Includes

- 1) GW-uni2 plus main body
- 2) USB Cable
- 3) Power adapter (19VDC)
- 4) PC Application program (CD)
- 5) User's manual (CD)
- 6) USB Driver file (CD)



GW-uni2 main body



**PC Application program
USB Driver file
User's Manual**



Power Adapter and Cable



USB Cable

2. Setup

2.1 Host system requirement

- 1) Over IBM Pentium PC.
- 2) Window XP / 7
- 3) CD-ROM, USB port
- 4) Operating System with 20MB of free Hard disk space
- 5) Over RAM 64MB

2.2 To install PC application program

- 1) Insert the installation CD into CD-ROM drive on your PC or download software at SEMINIX web site. (www.seminix.com).
- 2) Execute the setup file in CD.
- 3) Install PC application program in order according to the instruction.
- 4) The program is installed at the folder "C:\Program Files\seminix\GW-uni2 plus" when the installation is finished.

2.3 To install USB driver

- 1) Execute the "CDM v2.12.00 WHQL Certified.exe" in 'C:\Program Files\seminix\GW-uni2 plus\drives'.

2.4 GW-uni2 plus Configuration

- ① Socket connection port
- ② LCD panel
- ③ Touch Key
- ④ Power switch
- ⑤ Adapter connection port
- ⑥ USB connection port



Figure 2.4 GW-uni2 plus configuration (Front/Side)

3. PC Application Program

3.1 PC application program

- 1) Selection a device for program and send information of device to GW-uni2 plus.
- 2) Download a data for program to GW-uni2 plus buffer memory.
- 3) Set Program Option.
- 4) Program count can be cleared.
- 5) Execute Erase, Write, Verify, Blank Check, Device Checksum, Buffer Checksum, Dump and Read Buffer
- 7) GW-uni2 plus software upgrade.

3.2 Hardware setup

- 1) Connect a power adapter to GW-uni2 plus and turn on the power
- 2) Connect GW-uni2 plus to PC by USB cable.
- 3) Put a adapter socket in GW-uni2 plus.
- 4) Put a device chip in a socket adapter.



Figure 3.2 GW-uni2 plus Hardware setup

3.3 USB Connection

- 1) Execute the application program and click the USB connection icon.

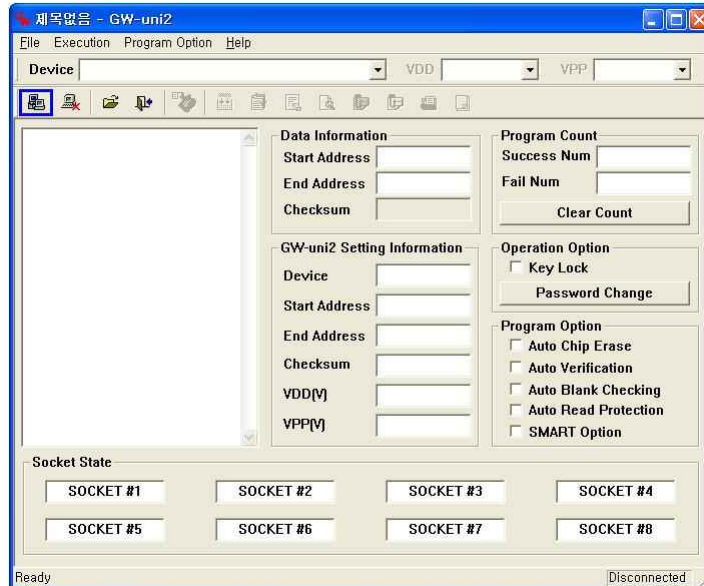

Figure 3.3.1 USB Connection

- 2) “* GW-uni2 plus is connected *” message and information of 'GW-uni2 plus setting', 'Program count' and 'Program Option setting' are displayed when GW-uni2 plus is connected by USB.

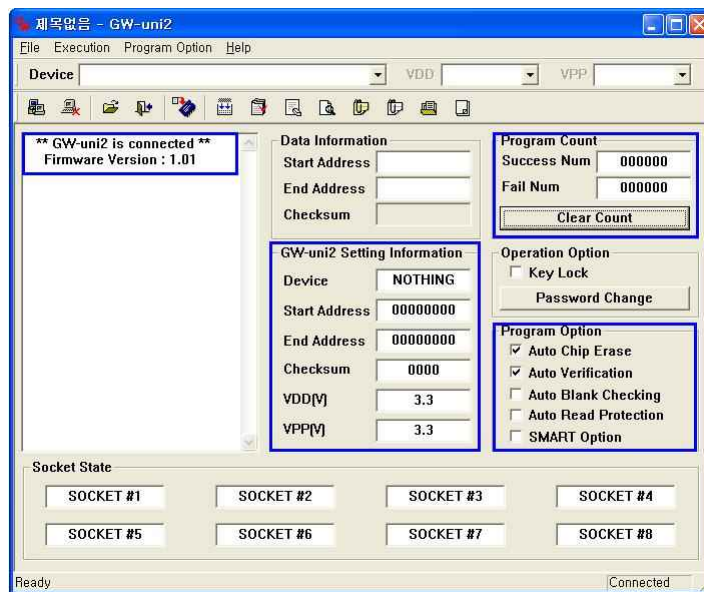

Figure 3.3.2 Finish USB connection

- * Try from 1) again when USB connection is failed.

3.4 Device selection

- 1) Click the 'Device' icon.

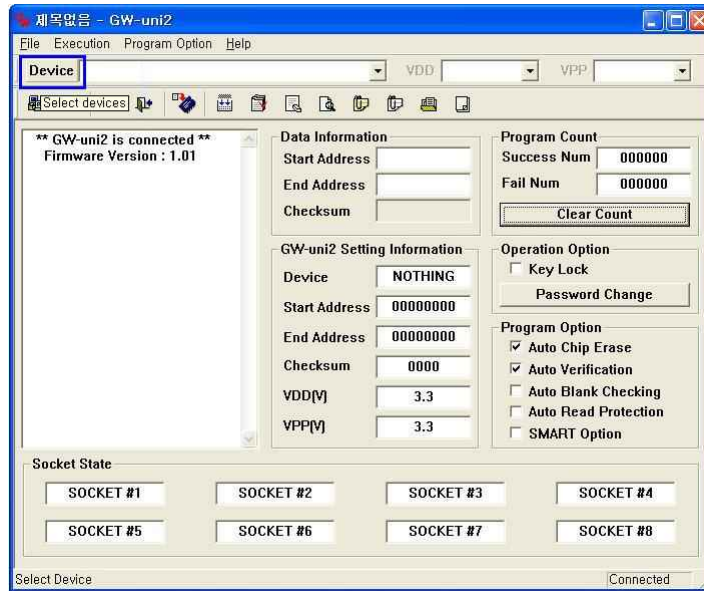

Figure 3.4.1 Device selection

- 2) 'Select Device' Window is displayed.

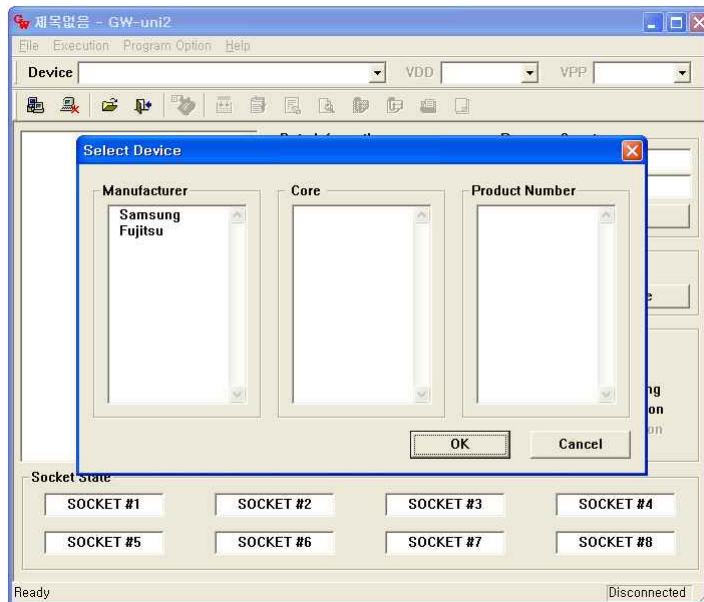

Figure 3.4.2 'Select Device' Window

3) Select a manufacturer, a Core and a product number.

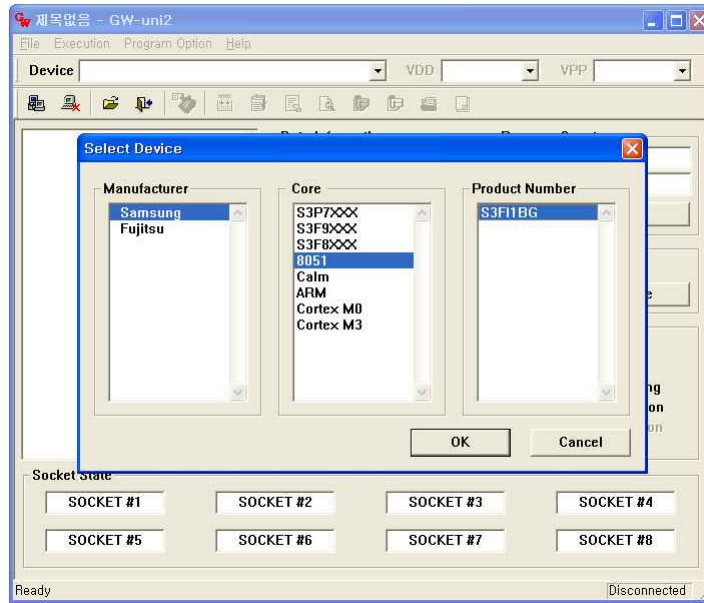

Figure 3.4.3 Device selection

4) A device information is showed when click the 'OK' icon.

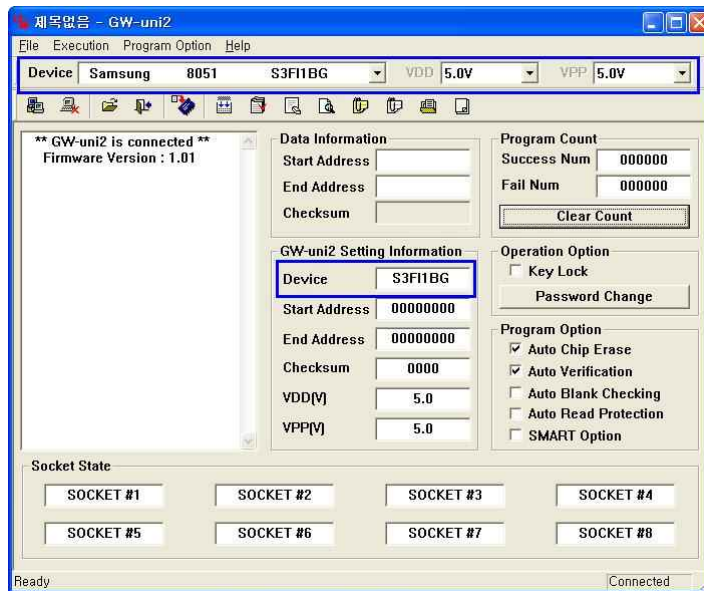

Figure 3.4.4 Display a device information

3.5. File open

- 1) Click the file open icon.

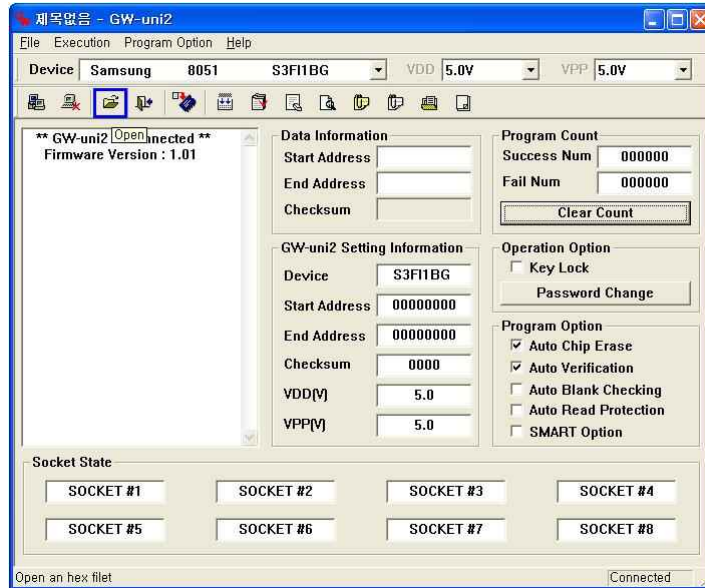

Figure 3.5.1 File open

- 2) Select a file(*.hex or *.bin).

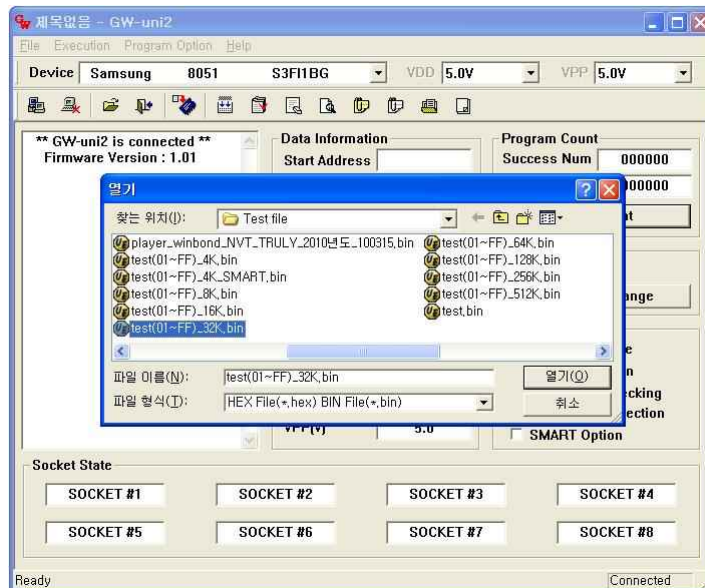

Figure 3.5.2 File selection.

3) Check the end address and checksum.

* It can take a little time for checksum depending on a file size.

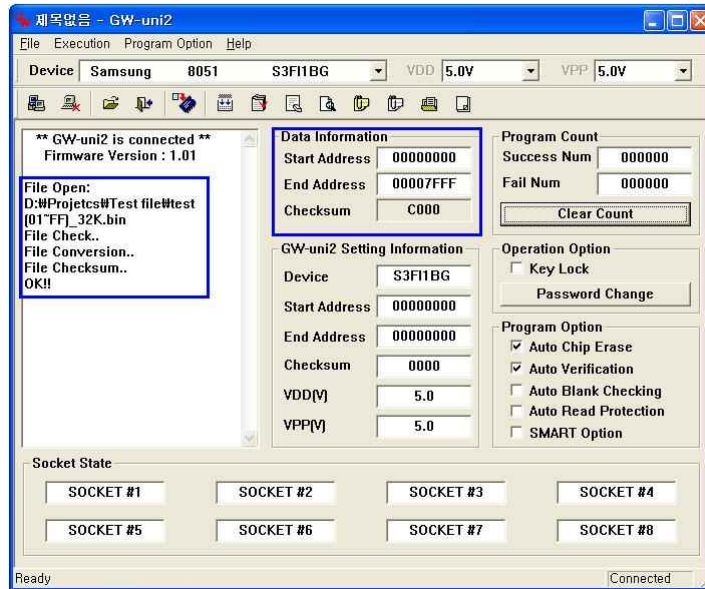

Figure 3.5.3 Finish the file selection

3.6 Program option

- 1) Select program option.
 - (1) Auto Chip Erase
 - (2) Auto Verification
 - (3) Auto Blank Checking : Check a device ROM data initialized(0xFF)
 - (4) Auto Read Protection : Device ROM data is read as '0'
 - (6) SMART Option

- 2) Process of program option.
 - (1) Chip Erase (Auto Chip Erase)
 - (2) Blank Check (Auto Blank Checking)
 - (3) Data Write
 - (4) SMART Option Write (SMART Option)
 - (5) Verify (Auto Verification)
 - (6) SMART Option Verify (SMART Option)
 - (7) Read Protection (Auto Read Protection)

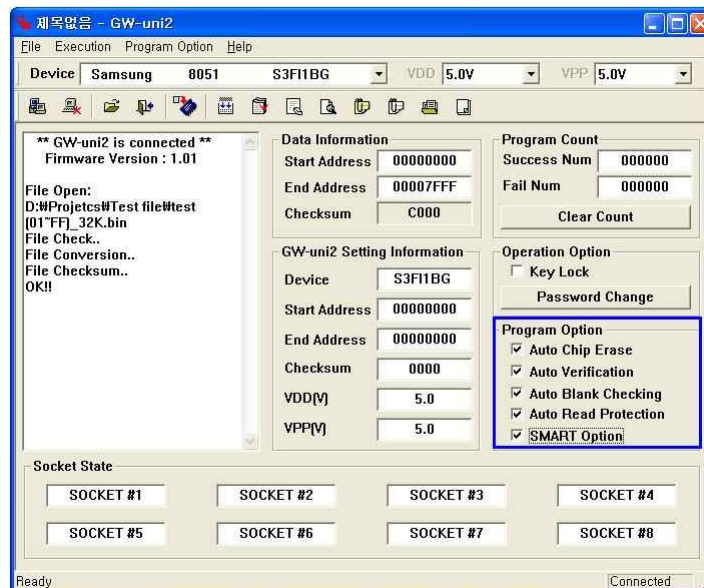

Figure 3.6.1 Program Option

3) There is an unavailable option depending on a selected device.

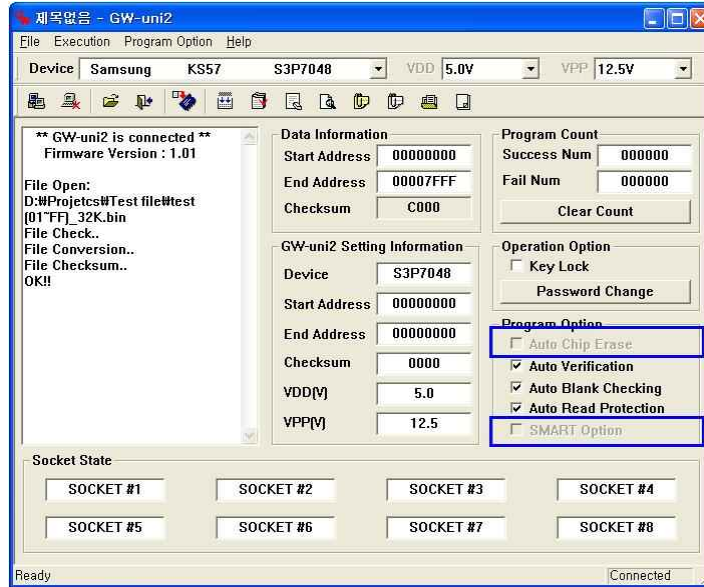

Figure 3.6.2 Program Option - unavailable Option

3.7 System Power(VDD), Program Power(VPP)

1) VDD : System power setting - User can set 3.3V or 5.0V.

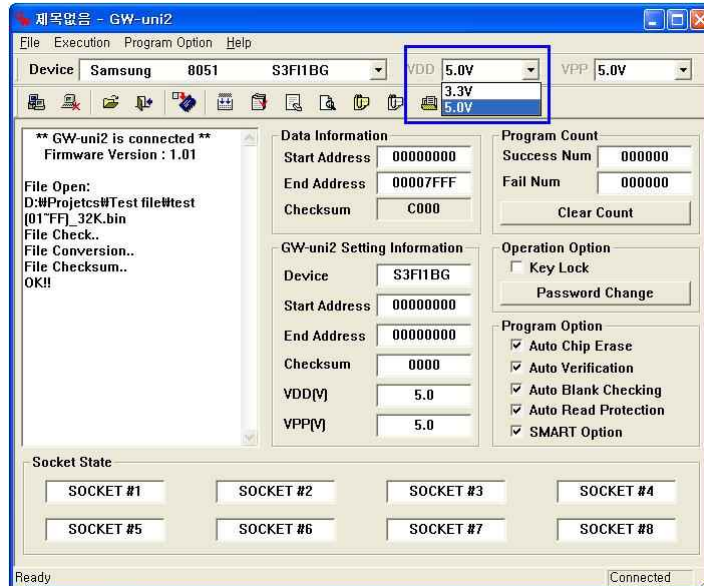

Figure 3.7.1 VDD setting

2) VPP : Program power setting - User can set VPP from 3.3V to 12.5V in the unit of 0.1V

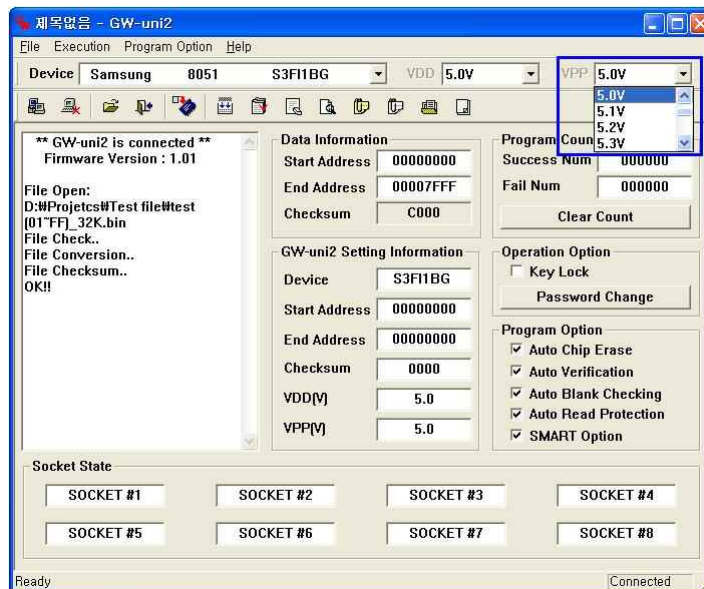

Figure 3.7.2 VPP setting

3.8 Program count

- 1) Success Num : Display the number of program success
- 2) Fail Num : Display the number of program fail

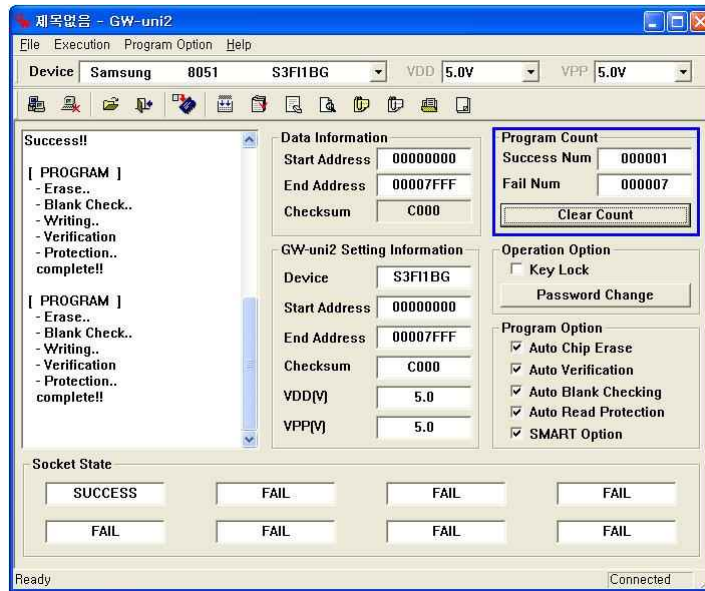

Figure 3.8.1 Program Count

- 3) The initialization window of 'Success Num' and 'Fail Num' is showed after click the 'Clear Count' button.
- 4) The count is initialized when user puts a password on 'Password' blank in 'Clear count' and clicks 'Clear Count' button.

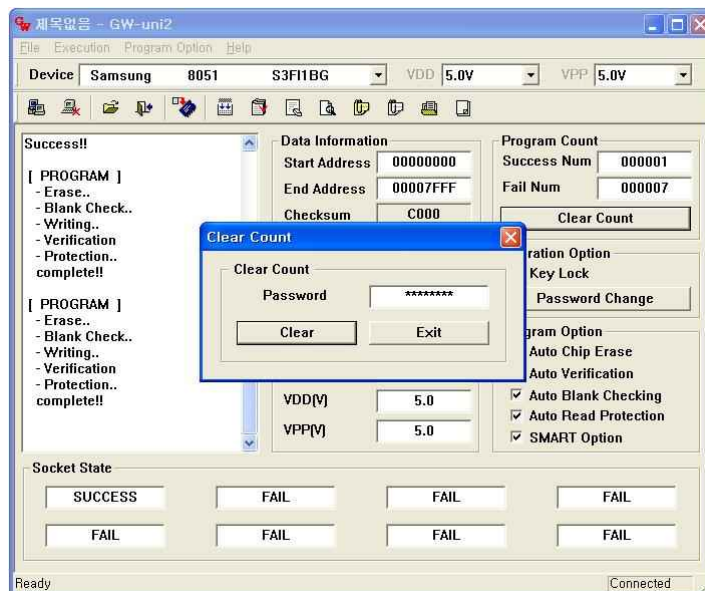

Figure 3.8.2 Clear Count

- 5) The 'Success: Count Cleared!' message window is showed when the initialization is normally finished.

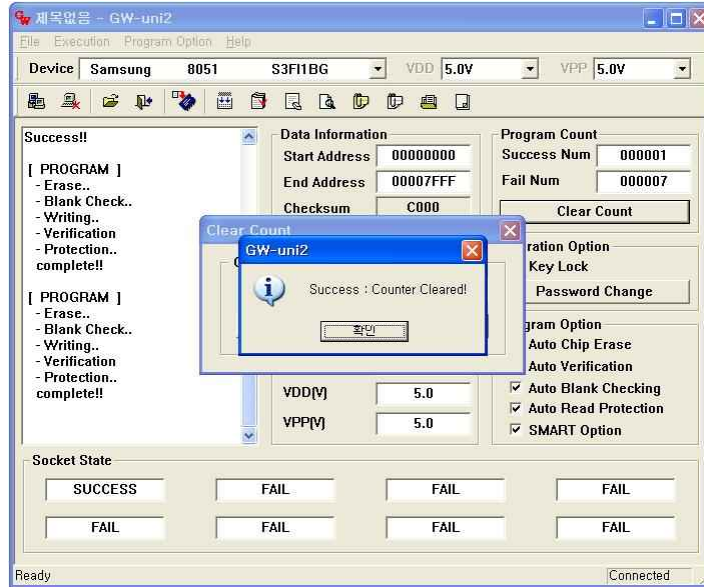

Figure 3.8.3 Success message

- 6) 'Success Num' and 'Fail Num' is initialized to '0' after the 'Clear Count' process is normally finished.

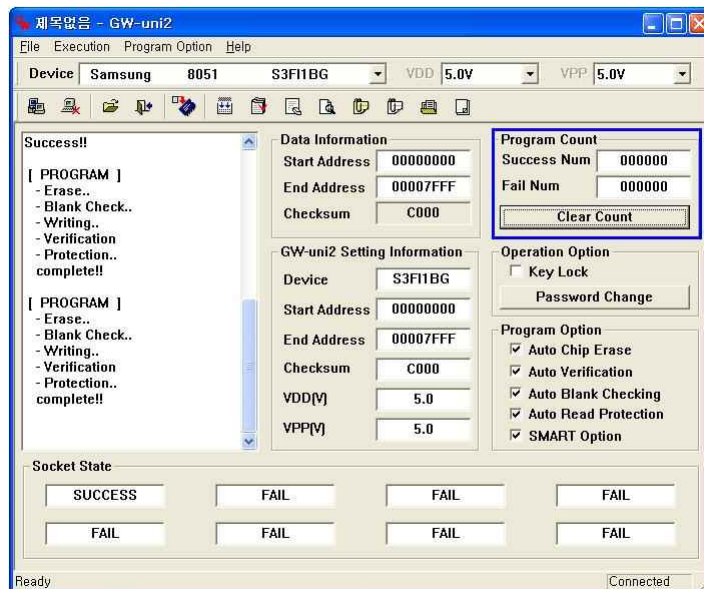

Figure 3.8.4 Clear Program Count

3.9 Data download

- 1) Save the selected file data, device information and program options etc. to GW-uni2 plus internal memory.

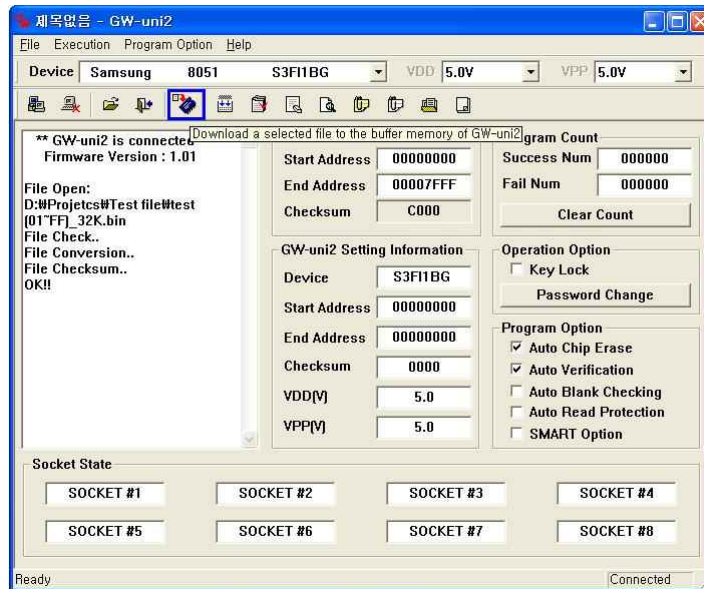

Figure 3.9.1 Download

- 2) Display the message "Download Success!" after download
- 3) Display information on 'GW-uni2 plus Setting Information' window after download.

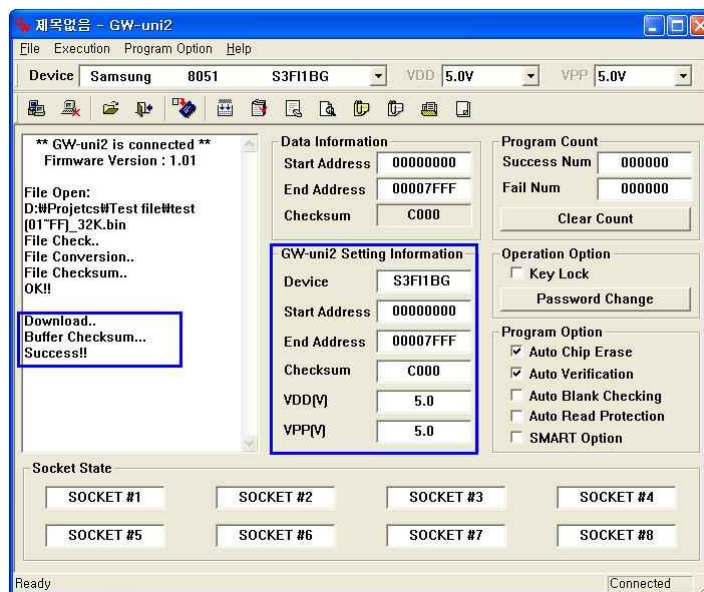

Figure 3.9.2 Download Success

3.10 Program

- 1) Write a data from GW-uni2 plus buffer memory to a device.
- 2) Execute selected program options in order.
- 3) Display the program result of each socket in 'Socket state' windows.
- 4) Program count is renewed.

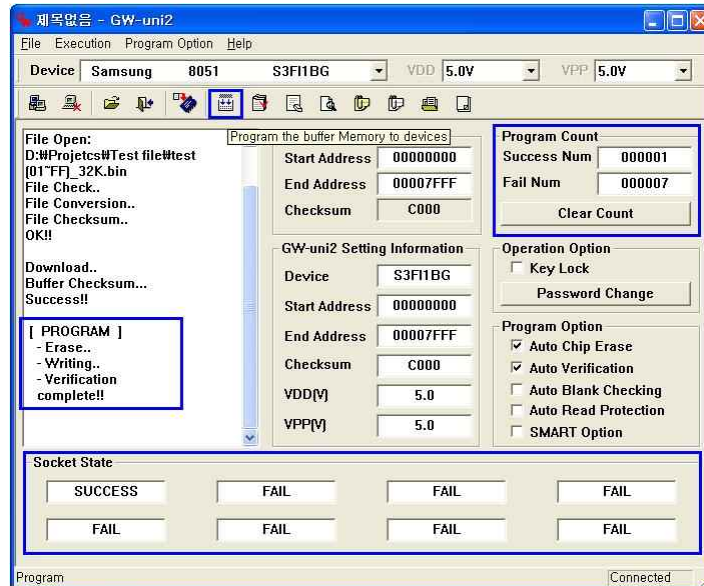

Figure 3.10 Program

3.11 Verify

- : Display the result after comparing a written data of a device and a data of a GW-uni2 plus buffer memory.

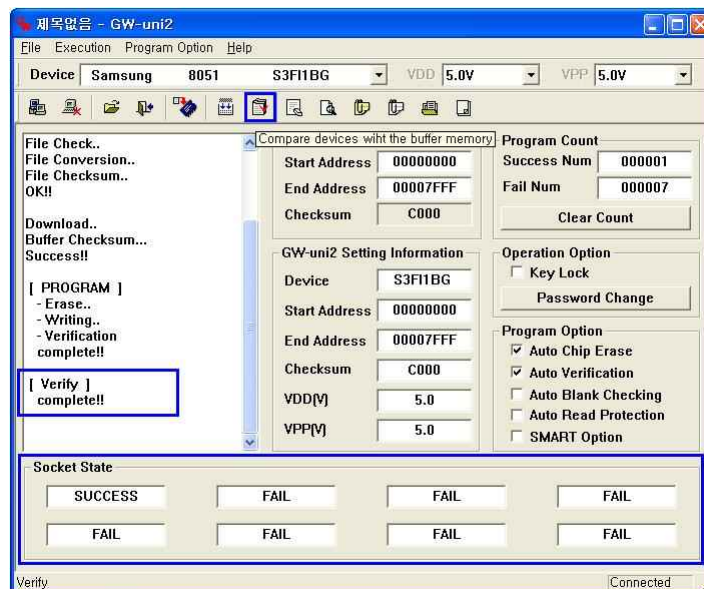

Figure 3.11 Verify

3.12 Chip erase

: Delete a device ROM data..

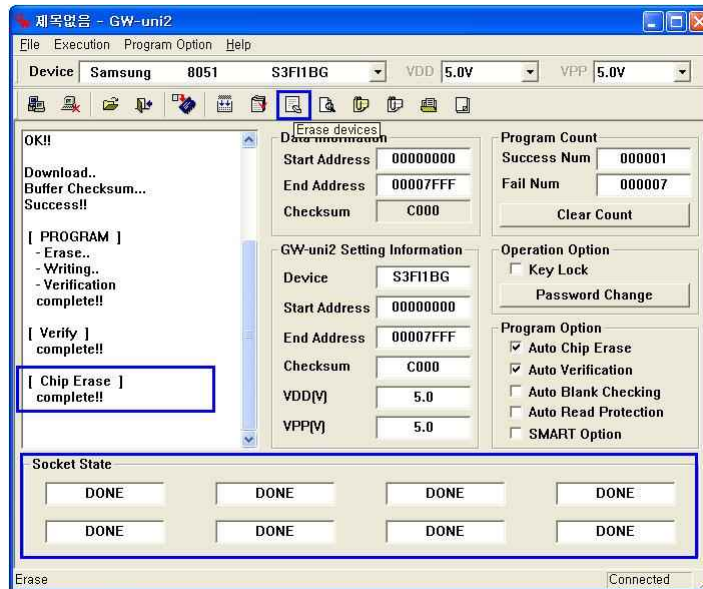

Figure 3.12 Erase

3.13 Blank check

: Check a device ROM data initialized(0xFF)

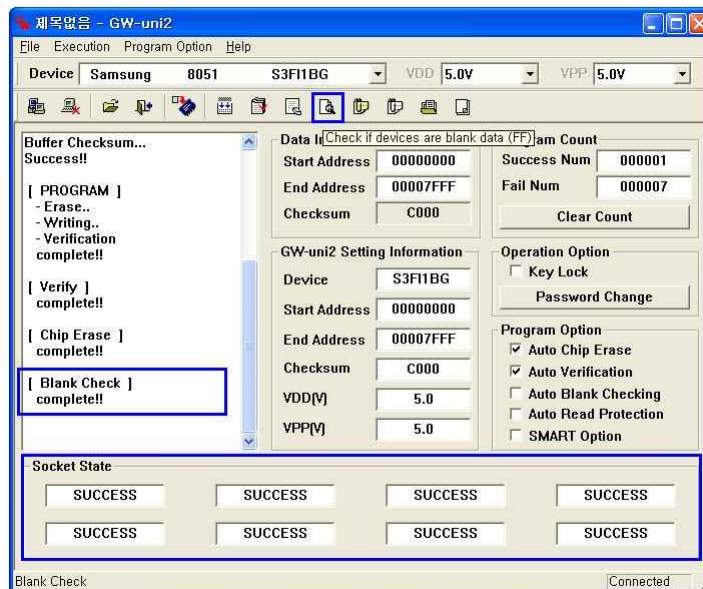

Figure 3.13 Blank Check

3.14 Device checksum

: Display a device checksum in the #1(Master) socket of 8 sockets.

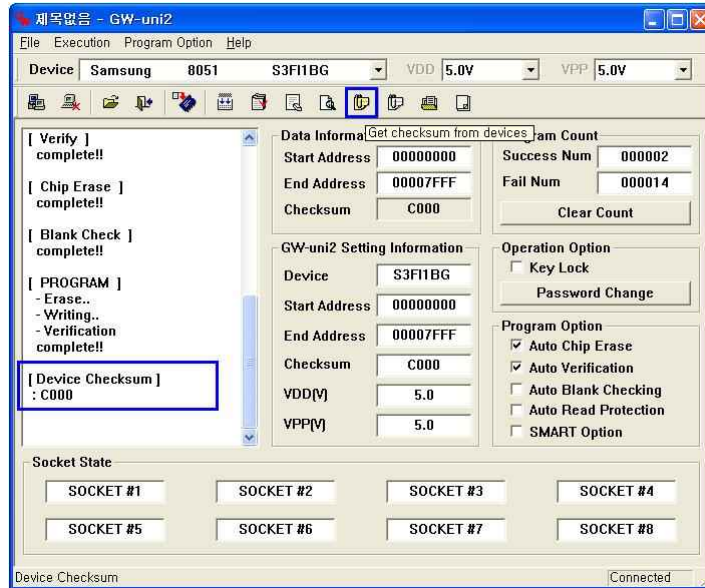

Figure 3.14 Device Checksum

3.15 Buffer checksum

: Display a checksum of GW-uni2 plus internal memory data.

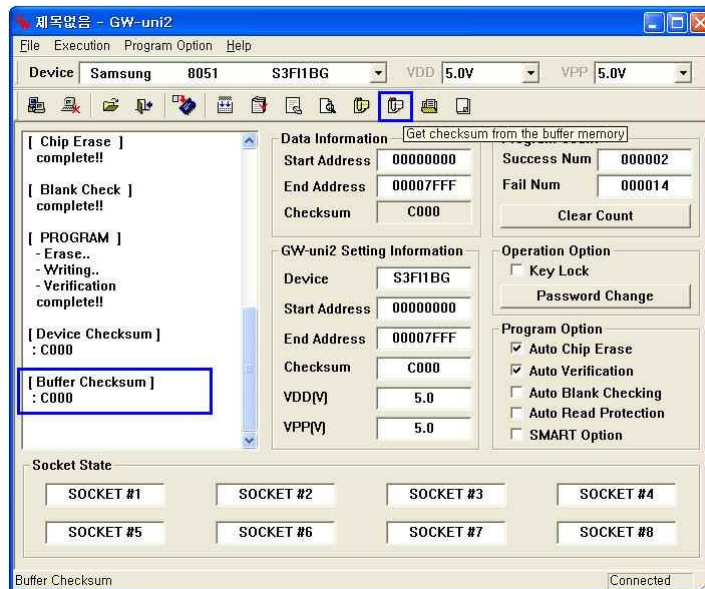

Figure 3.15 Buffer Checksum

3.16 Dump

: Display buffer memory or device ROM data.

- 1) Execute the Dump window after clicking the dump icon.

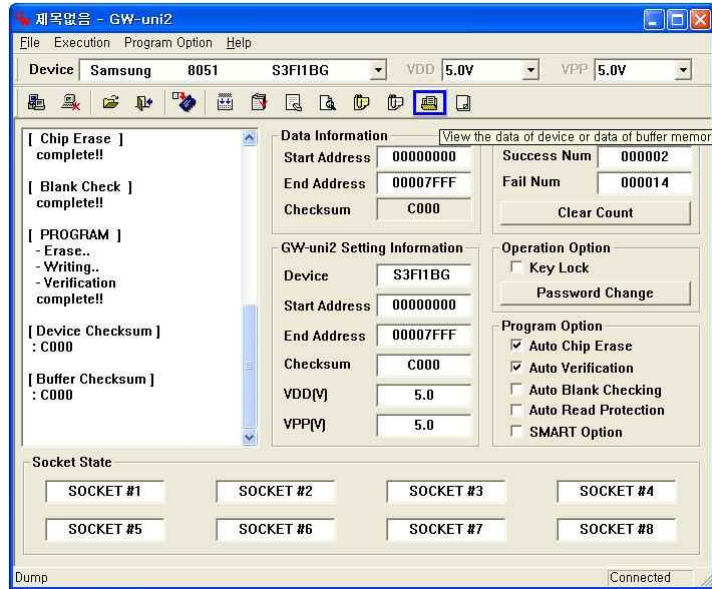

Figure 3.16.1 Dump execution

- 2) Address is changed by '<<' and '>>' button.
- 3) 'Buffer Memory' : Display buffer memory data.
- 4) 'Device<Socket#1>' : Display device ROM data in a socket #1.

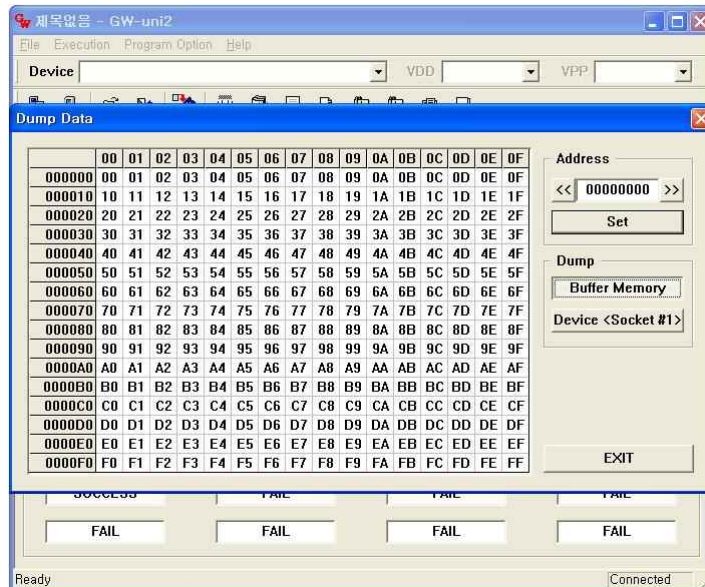

Figure 3.16.2 Dump window

3.17 Read Buffer

: Read data in buffer memory and save it as an intel hex file to PC

1) Click 'Read Buffer' button and the password window is displayed.

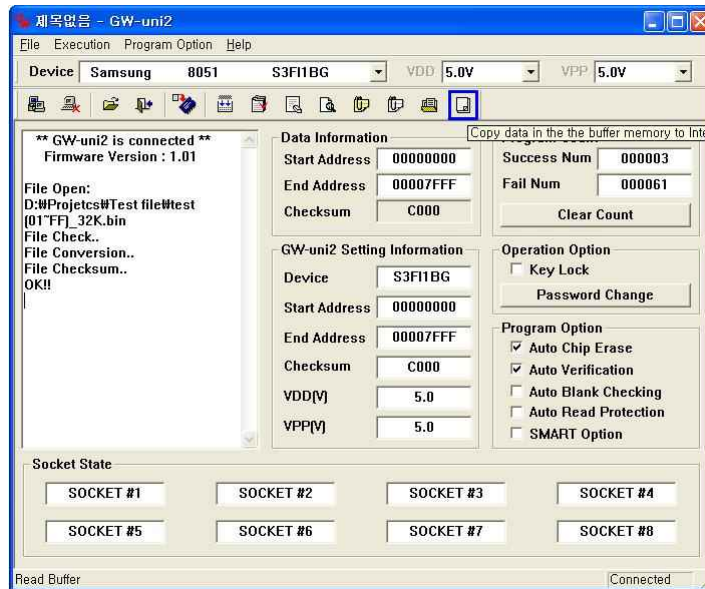

Figure 3.17.1 Read Buffer execution

2) Input password and click 'Check' button and start to execute Read Buffer.

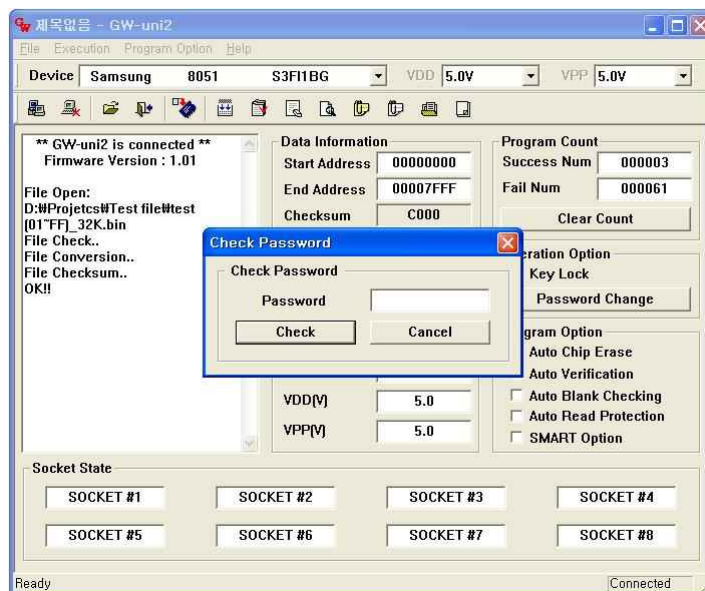

Figure 3.17.2 Input password

3) File address is displayed after 'Read Buffer' is completed

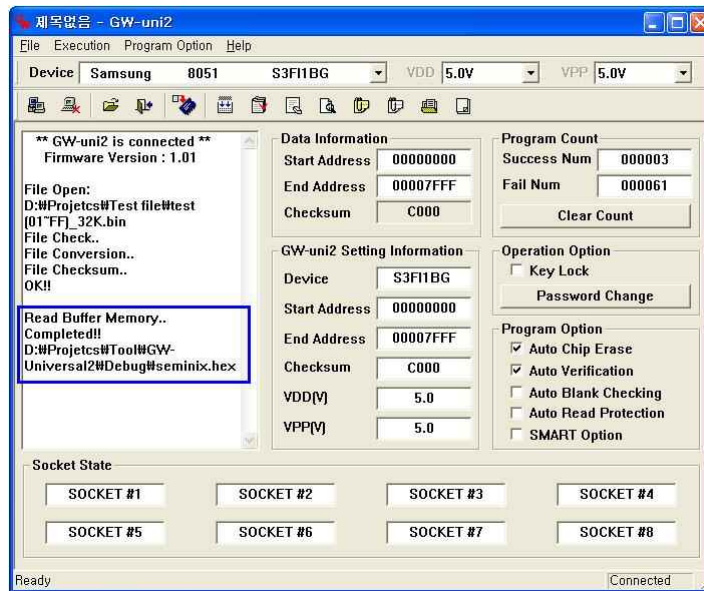

Figure 3.17.3 Complete 'Read Buffer'

3.18 Key Lock

: If the 'Key Lock Selected', the following function will be protected

- PC Application Program

- : 'Device Selection', 'Download', 'Program Option', 'Dump' function

- Stand-alone mode

- : 'Device Setting', 'Program Option' and 'Read Device' function

1) Click the 'Key Lock' check box and 'Key Lock' setting window is displayed.

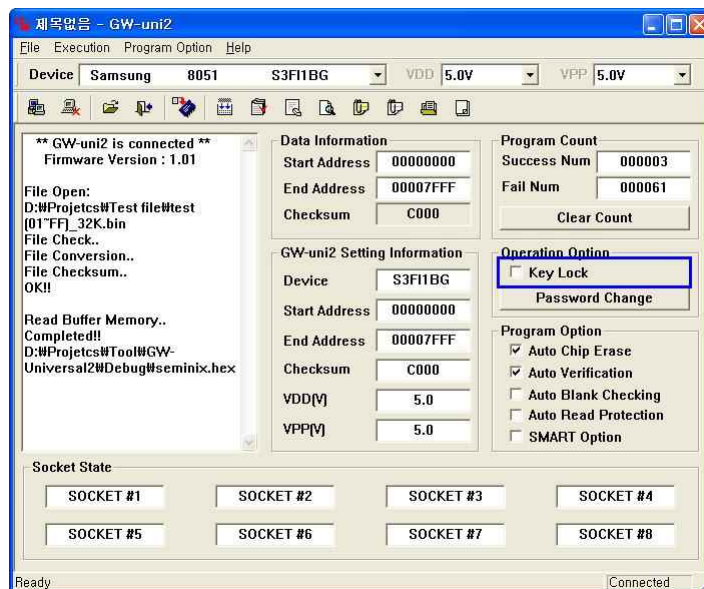

Figure 3.18.1 Key Lock execution

- 2) Input password and click 'Lock' or 'Unlock' button
- 3) 'Lock' : Set the key lock
- 4) 'Unlock': Set the key unlock
- 5) 'Exit'

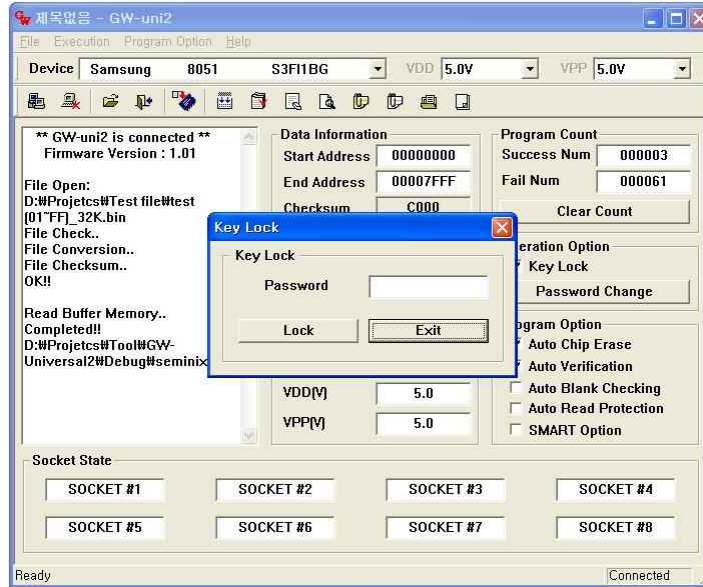

Figure 3.18.2 Key Lock

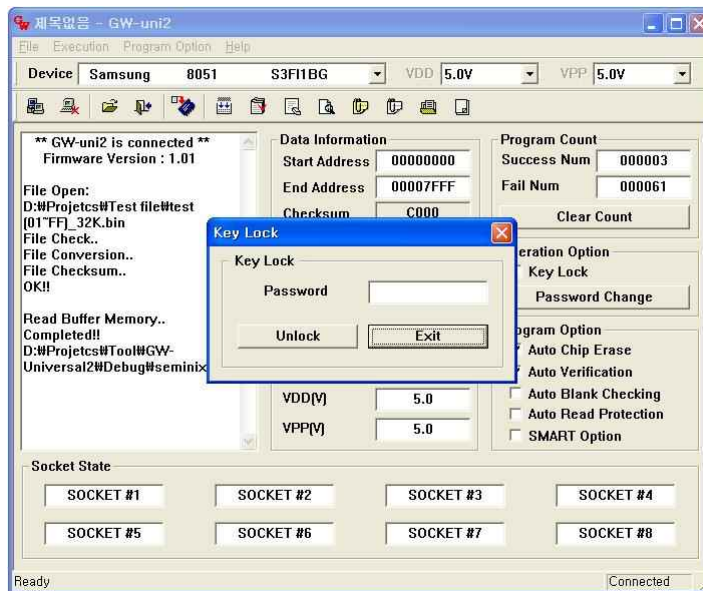

Figure 3.18.3 Key Unlock

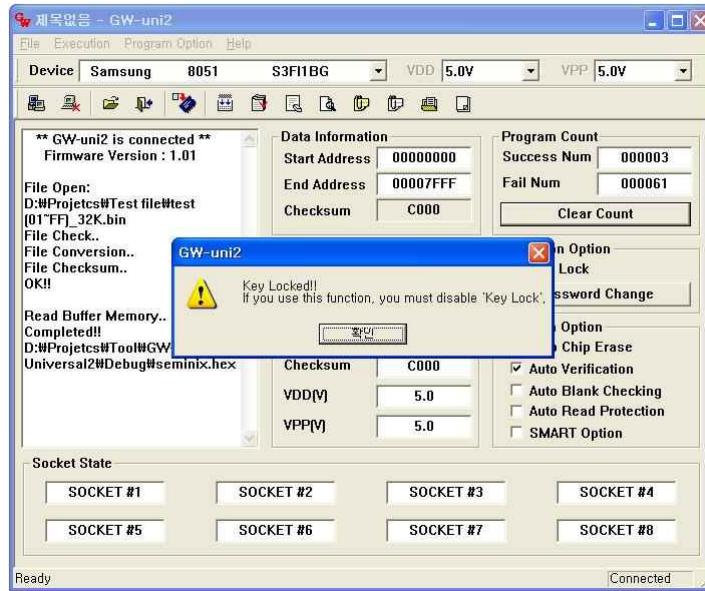

Figure 3.18.4 Key lock mode - Device Selection Error

- * This function helps to avoid an operator's mistake in the mass production line.
- * You must set Password before use this function.(refer to 3.19 Password Change)

3.19 Password Change

: Change password

- 1) Click the 'Password Change' button and the 'Password' setting window is displayed

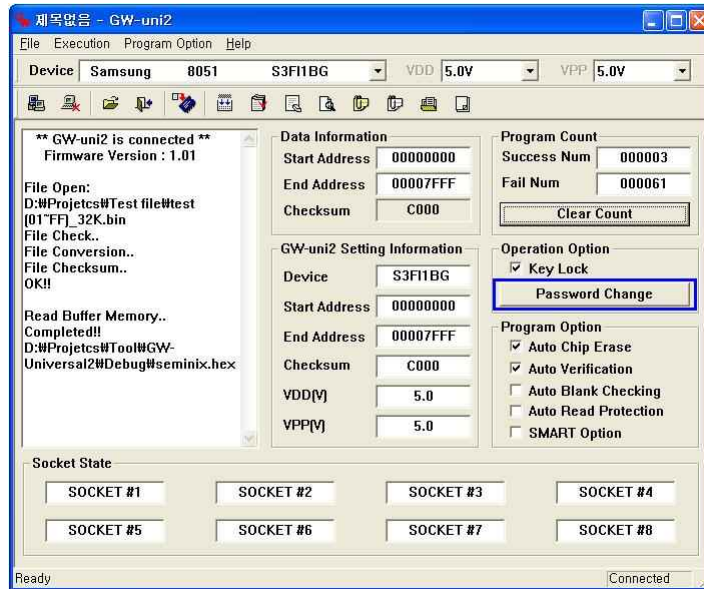

Figure 3.19.1 'Password Change' execution

- 2) Input a previous password in 'Password' blank box and input a new password in 'New Password' blank box and click 'Change' button to change the password

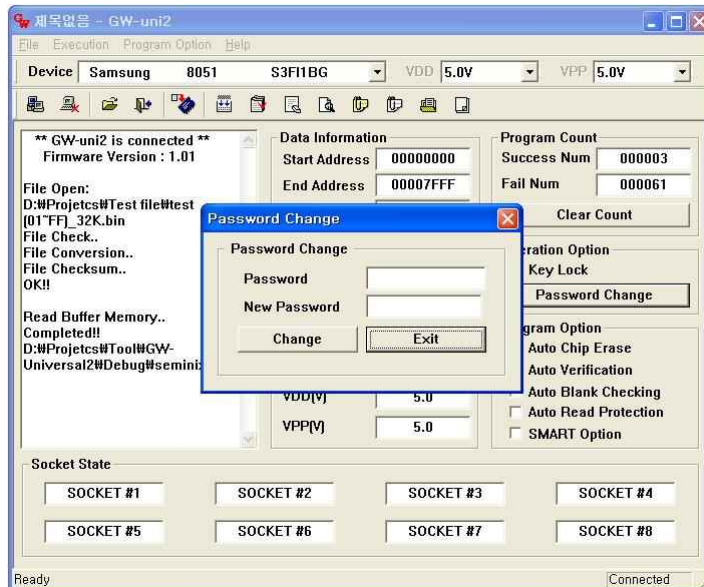

Figure 3.19.2 Password Change

3) A message window about a result is displayed after changing password.

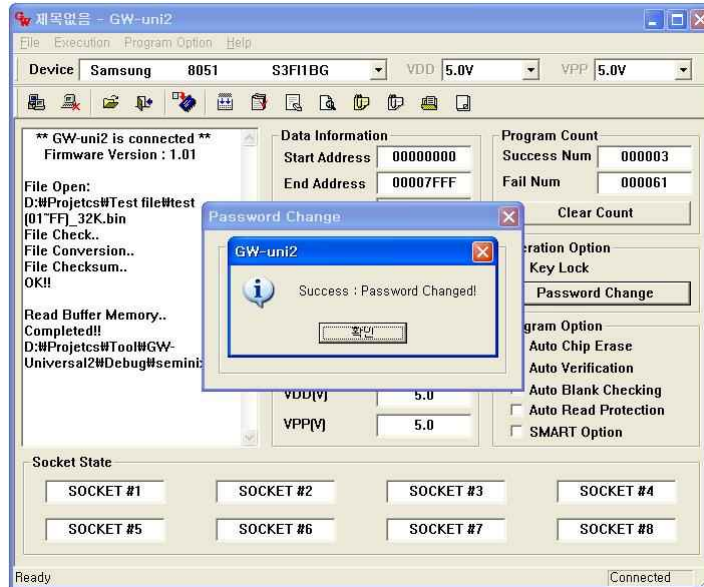

Figure 3.19.3 Finish Password Change

- A password is not set at first
- Password can be set to maximum 8 words.
- Password is not set when 'New Password' blank box is not filled.

3.20 Socket state

: Display an operating result on each socket.

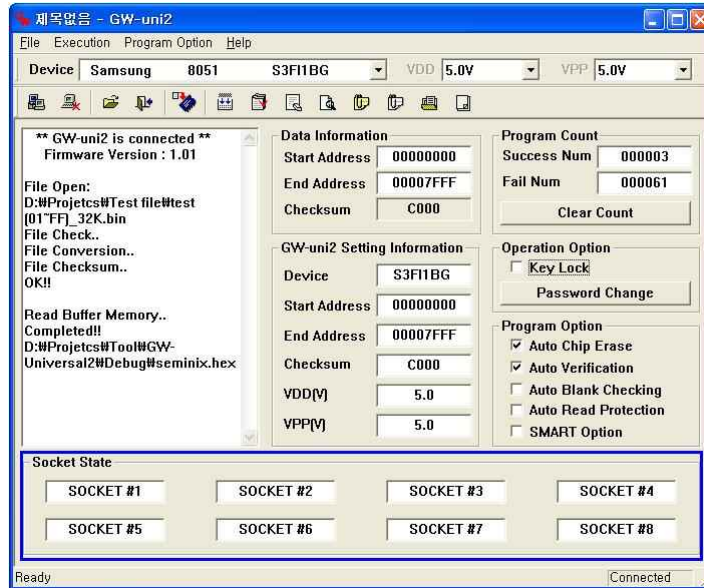

Figure 3.20 Display a socket state

3.21 State window

: Display an operating result on the 'Socket State' window.

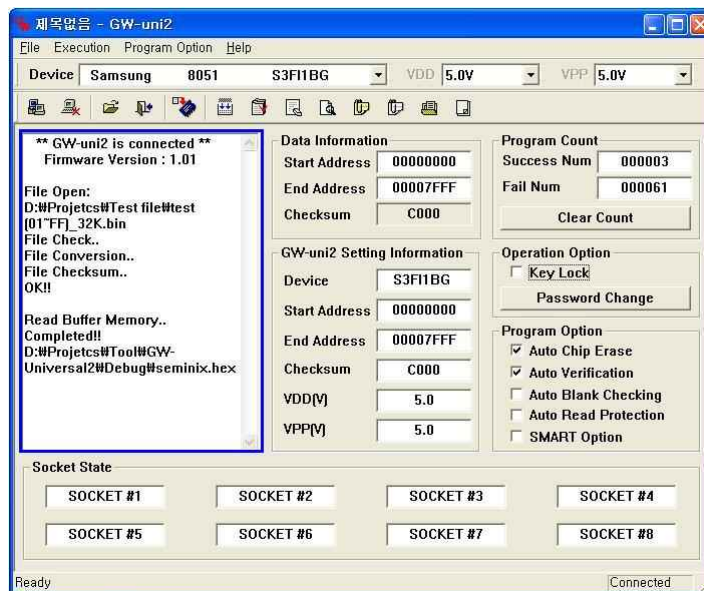

Figure 3.21 State Window

3.22 GW-uni2 plus Setting window

: Display GW-uni2 plus setting state.

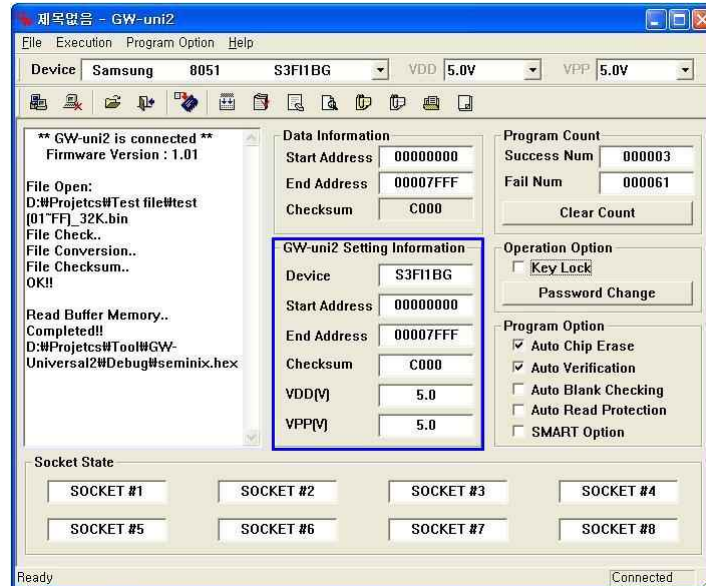

Figure 3.22 GW--uni2 setting window

- 1) Device : Display a device name.
- 2) Start Address : Display a program start address.
- 3) End Address : Display a program end address.
- 4) Checksum : Display a data checksum which is downloaded.
- 5) VDD : Display a system voltage.
- 6) VPP : Display a program voltage.

GW-uni2 plus works based on GW-uni2 plus setting information so check whether GW-uni2 plus setting is changed after changing GW-uni2 plus setting information. (device information, Program option, Download etc.)

** The setting value is displayed when GW-uni2 plus is connected to PC GW-uni2 plus normally.*

3.23 Upgrade

- Upgrade GW-uni2 plus software.
- Please check a new firmware file at SEMINIX homepage(www.seminix.com) periodically
- User can check the version information at 'Help -> About GW-uni2 plus...' menu

1) Upgrade process

- (1) Write "UPGRD" to the 'Start Address' blank and then enter the 'Enter' key.

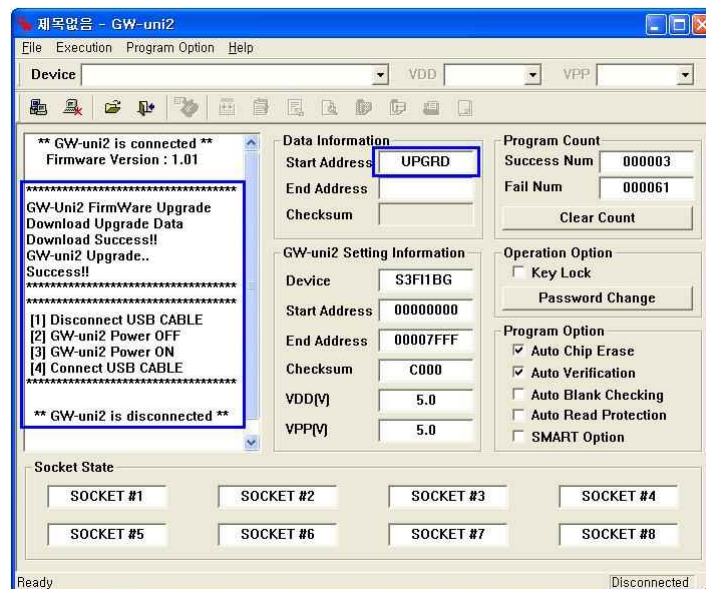

Figure 3.23 Upgrade Start

- (2) The upgrade data is downloaded when user enters 'Enter key'
- (3) GW-uni2 plus is upgraded after finish the download.
- (4) Restart GW-uni2 plus about 20 min later (Power off -> Power On)

4. Stand-alone mode

4.1 System on and initialization

: To use GW-uni2 plus with stand-alone mode, user should setup PC application program and download a data first

Touch keys don't work if the USB cable is connected so please disconnect USB cable for the stand-alone mode.

- 1) Set a device with reference to '3.4 Device selection'
- 2) Set a program option with reference to '3.6 Program Option'
- 3) Download a data with reference to '3.5 File Open','3.9 Data Download'
- 4) Disconnect USB cable. (The key is not working when USB cable is connected)
- 5) The system information is kept until user set it again.

4.2 LCD display information

: There is a program standing mode when user turns on GW-uni2 plus power after initialization

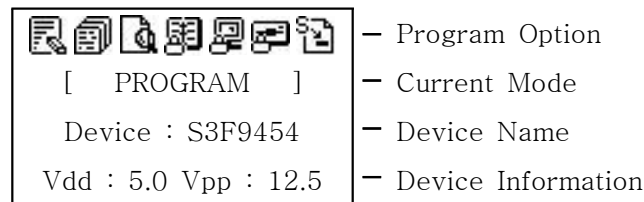









Figure 4.2 LCD display

1) Program Option : Display Program option

- (1)  : Auto Chip Erase
- (2)  : Auto Verification
- (3)  : Auto Blankcheck
- (4)  : Auto Read Protection
- (5)  : Auto LDC Protection
- (6)  : Auto Hard Lock
- (7)  : SMART Option

2) Current Mode : Display a current mode.

- (1) PROGRAM, VERIFICATION, ERASE, BLANK CHECK, DVC CHECKSUM, and BUF CHECKSUM
- (2) A mode is changed in order when touch 'LEFT' and 'RIGHT' keys.

3) Device Name

: Display a device name.(Display 'Nothing' when there is not any selected device)

4) Device Information : Display Device setting information..

- (1) Vdd : System Power (Voltage)
- (2) Vpp : Program Power (Voltage)
- (3) E.A : End Address (Hex)
- (4) Checksum : Buffer Checksum (Hex)

4.3 Program mode

: Program standing state

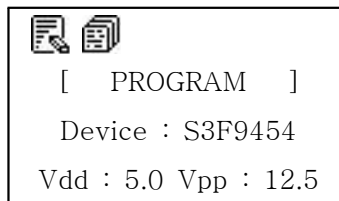

Figure 4.3.1 Program Mode

- 1) Touch 'PROGRAM' key and execute the program mode.

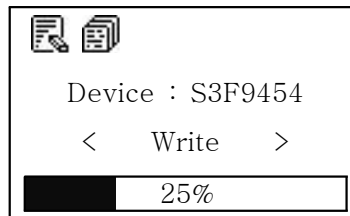

Figure 4.3.2 Program Mode – Write to a device

- 2) Execute a program option together
- 3) Touch the 'RIGHT' key for 'Verification mode'
- 4) Touch the 'LEFT' key for 'Buf Checksum mode'
- 5) Touch the 'MENU' key for 'Menu mode'.

4.4 Verification mode

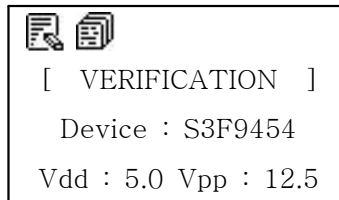

Figure 4.4.1 Verification Mode

- 1) Touch the 'PROGRAM' key for verify.

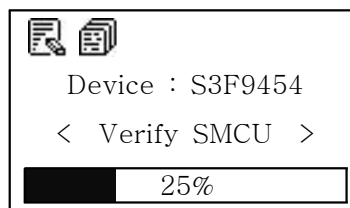

Figure 4.4.2 Verification mode - Verify

- 2) Touch the 'RIGHT' key for 'Erase mode'.
- 3) Touch the 'LEFT' key for 'Program mode'.
- 4) Touch the 'MENU' key for 'Menu mode'.

4.5 Erase mode

: Make a device ROM initialize (0xff)

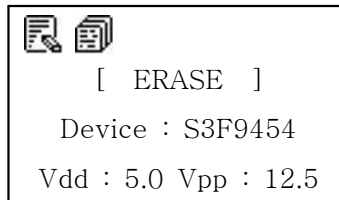

Figure 4.5.1 Erase Mode

1) Touch the 'PROGRAM' key for erase.



Figure 4.5.2 Erase Mode - Erase

- 2) Touch the 'RIGHT' key for 'Blank Check mode'.
- 3) Touch the 'LEFT' key for 'Verification mode'.
- 4) Touch the 'MENU' key for 'Menu mode'.

4.6 Blank Check mode

: Check a device ROM data initialized(0xff)

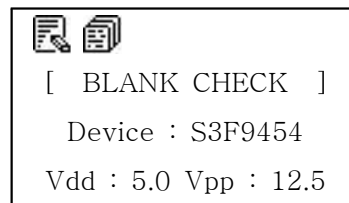

Figure 4.6.1 Blank check mode

1) Touch the 'PROGRAM' key for 'Blank Check'.

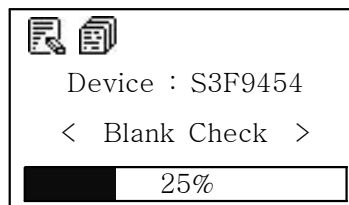

Figure 4.6.2 Blank check mode - Blank check

- 2) Touch the 'RIGHT' key for 'DVC Checksum mode'.
- 3) Touch the 'LEFT' key for 'Erase mode'.
- 4) Touch the 'MENU' key for 'Menu mode'.

4.7 Device Checksum mode

: Get a device checksum in the first socket(Master) of 8 sockets

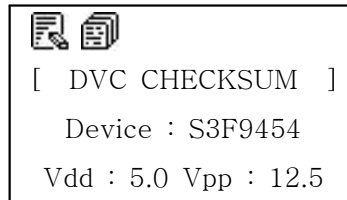

Figure 4.7.1 Device checksum mode

1) Touch the 'PROGRAM' key for device checksum.

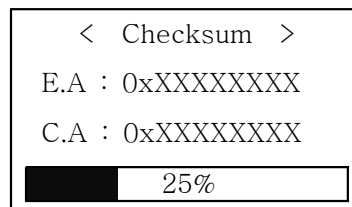

Figure 4.7.2 Device Checksum - Loading

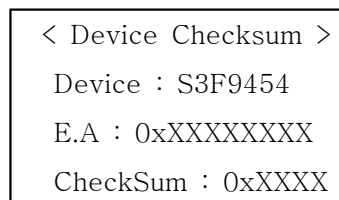

Figure 4.7.3 Device Checksum - Done

- 2) Touch the 'RIGHT' key for 'BUF Checksum mode'.
- 3) Touch the 'LEFT' key for 'Blank Check mode'.
- 4) Touch the 'MENU' key for 'Menu mode'.

* *E.A* : End Address

* *C.A* : Current Address

* *Checksum* : 2byte

4.8 Buffer Checksum

: Display a checksum of GW-uni2 plus buffer memory.

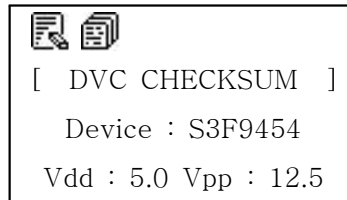

Figure 4.8.1 Device checksum mode

1) Touch the 'PROGRAM' key for 'Buffer Checksum'.

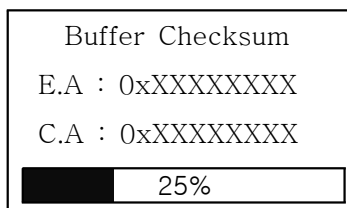

Figure 4.8.2 Buffer Checksum - Loading

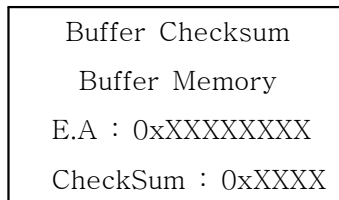

Figure 4.8.3 Buffer Checksum - Done

- 2) Touch the 'RIGHT' key for 'Program mode'..
- 3) Touch the 'LEFT' key for 'DVC Check mode'.
- 4) Touch the 'MENU' key for 'Menu mode'.

* *E.A* : End Address

* *C.A* : Current Address

* *Checksum* : 2byte

4.9 Menu mode

: Touch the key for Menu mode in 'Program Mode', 'Verification Mode' and 'Erase Mode'

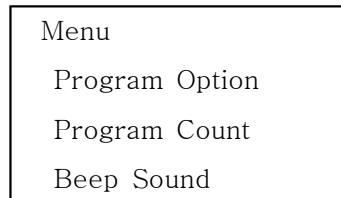

Figure 4.9.1 Menu Mode

1) Menu

- (1) Program Option : Select a program option.
- (2) Program Count : Display the programmed device number.
- (3) Beep Sound : On and off the beep sound.
- (4) Read Device : Read a device ROM data and save it to a buffer memory.
- (5) Information : Display GW-uni2 plus information.
- (6) Return : Return to previous mode.

2) Display the chosen menu with an inverted color.

3) Menu can be changed by 'UP' and 'DOWN' key.

4) Touch the 'MENU' key to select a chosen menu.

5) Touch the 'PROGRAM' key for a previous mode.

4.10 Program Option

: Change a program option.

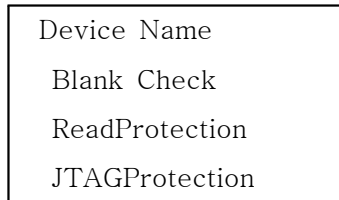

Figure 4.10 Program Option

- 1) Display an icon when an option is chosen.
- 2) An option can be changed by 'UP' and 'DOWN' key.
- 3) Touch the 'MENU' key to select a chosen option.
- 4) Touch the 'PROGRAM' key for a previous mode.
- 5) Back to a menu mode when 'Return' is selected.

**This program option can't be used if there is the 'Key lock' setting.*

4.11 Program Count

- (1) Success : The number of program success.
- (2) Fail : The number of program fail.

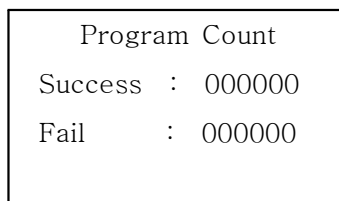

Figure 4.11 Program Count

4.12 Beep Sound

: On and off beep sound.

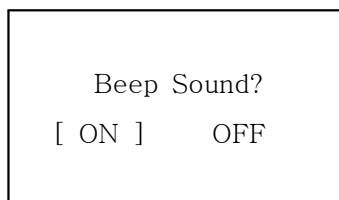

Figure 4.12 Beep Sound

4.13 Read Device

: Read a device ROM data in the socket #1 and save it to GW-uni2 plus buffer memory.

- 1) Display a confirmation window when a device is selected.

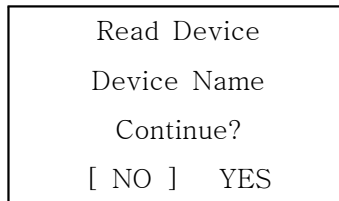

Figure 4.11.1 Read Device confirmation

- 2) Back to a menu mode when 'NO' is selected.
- 3) Execute 'Read Device' when 'YES' is selected.

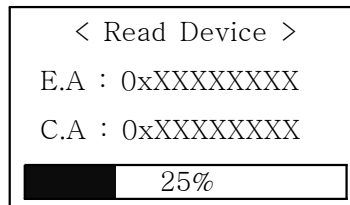

Figure 4.12.3 Read Device - Loading

- 4) Back to a previous mode when 'Read Device' is finished.

****This Read Device can't be used if there is the 'Key lock' setting.***

4.14 Information

- (1) Display a hardware version.
- (2) Display a software version.
- (3) Display a buffer memory size.

INFORMATION	
H / W	: Ver 2.0
S / W	: Ver 1.0
Memory	: 100 MB

Figure 4.14 Information

4.15 Return

: Back to the previous mode (Program Mode, Verification Mode, Erase Mode)

4.17 Result

- 1) Display an operating result of each socket.
- 2) Display "G" with programming success.
Display "F" with programming fail.
Display "I" with Socket Mismatch fail. (Device setting - Socket)
Display "E" with End of Socket-Life-Time.

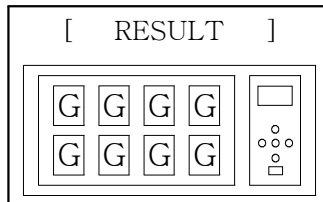

Figure 4.17 Display LCD Result

4.18 Socket LED

State		LED RED	LED GREEN
Stand By		OFF	ON
Execute Function		X	X
Result	Success	OFF	OFF
	Fail	ON	OFF

Table 4.18 Socket LED Description

4.19 Socket Life Time

The socket adapter consists of several mechanical parts so that it is consumption goods, whose life time is limited. GW-uni2 plus will display the warning message on the LCD of GW-uni2 plus when the programming counts of the socket adapter reaches the life time (counts) of its socket adapter.

[WARNIGN!]			
Socket LifeTime			
#1	#2	#4	Socket No.
	#6	#8	Socket No.

4.19 Socket Life Time

After the warning message is displayed, GW-uni2 plus will program the devices continuously until 10% over counts than the life time count of socket adapter.

So GW-uni2 plus will not program the devices when the programming count is over than

10% of the life time (count) of the socket adapters because the programming reliability could not be guaranteed.

Please change the used socket adapters into new ones in case of that, and then program the devices continuously.

5. Operation Sequence

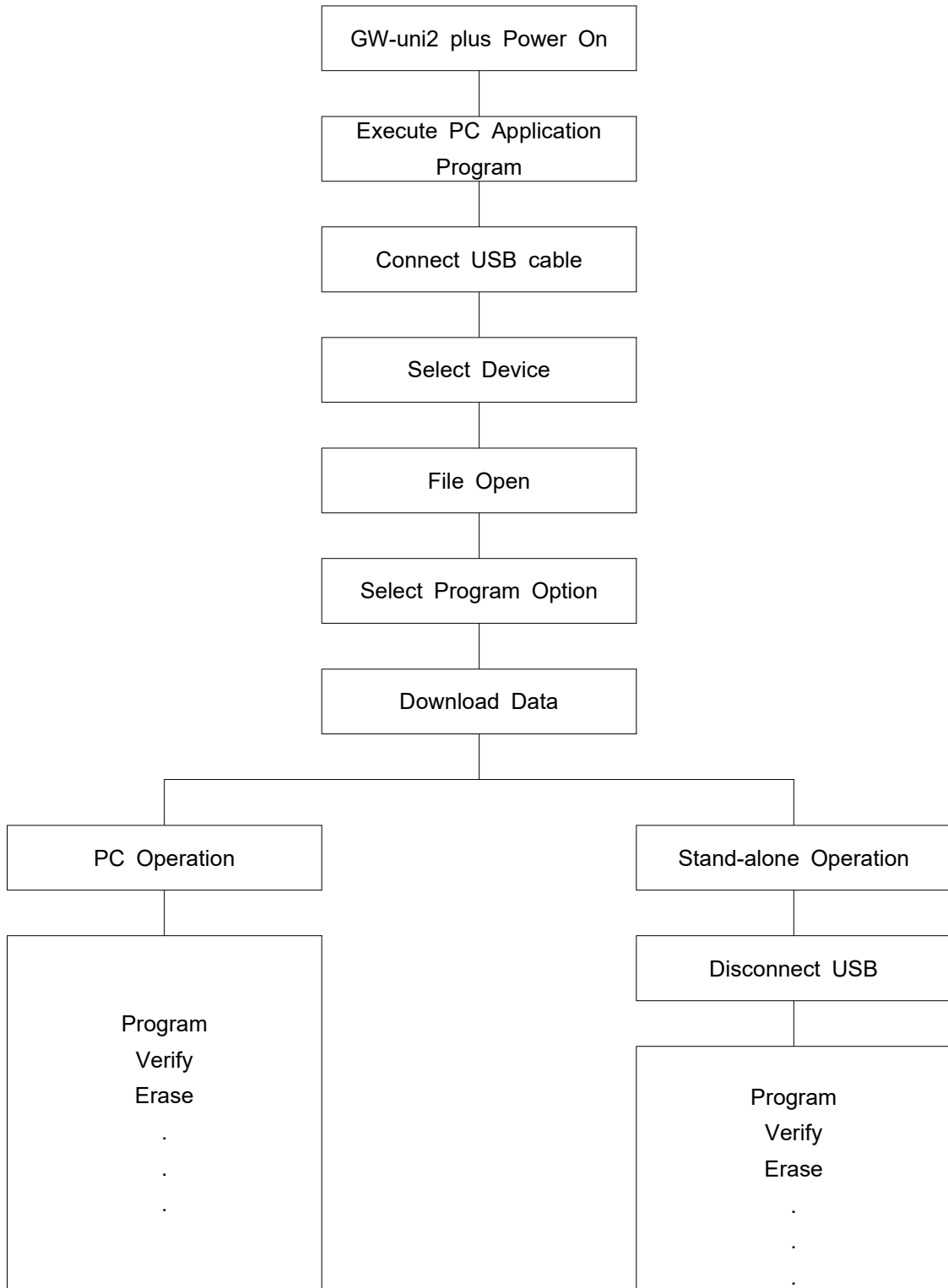

Figure 5.1 Operation Sequence

6. Key Function map

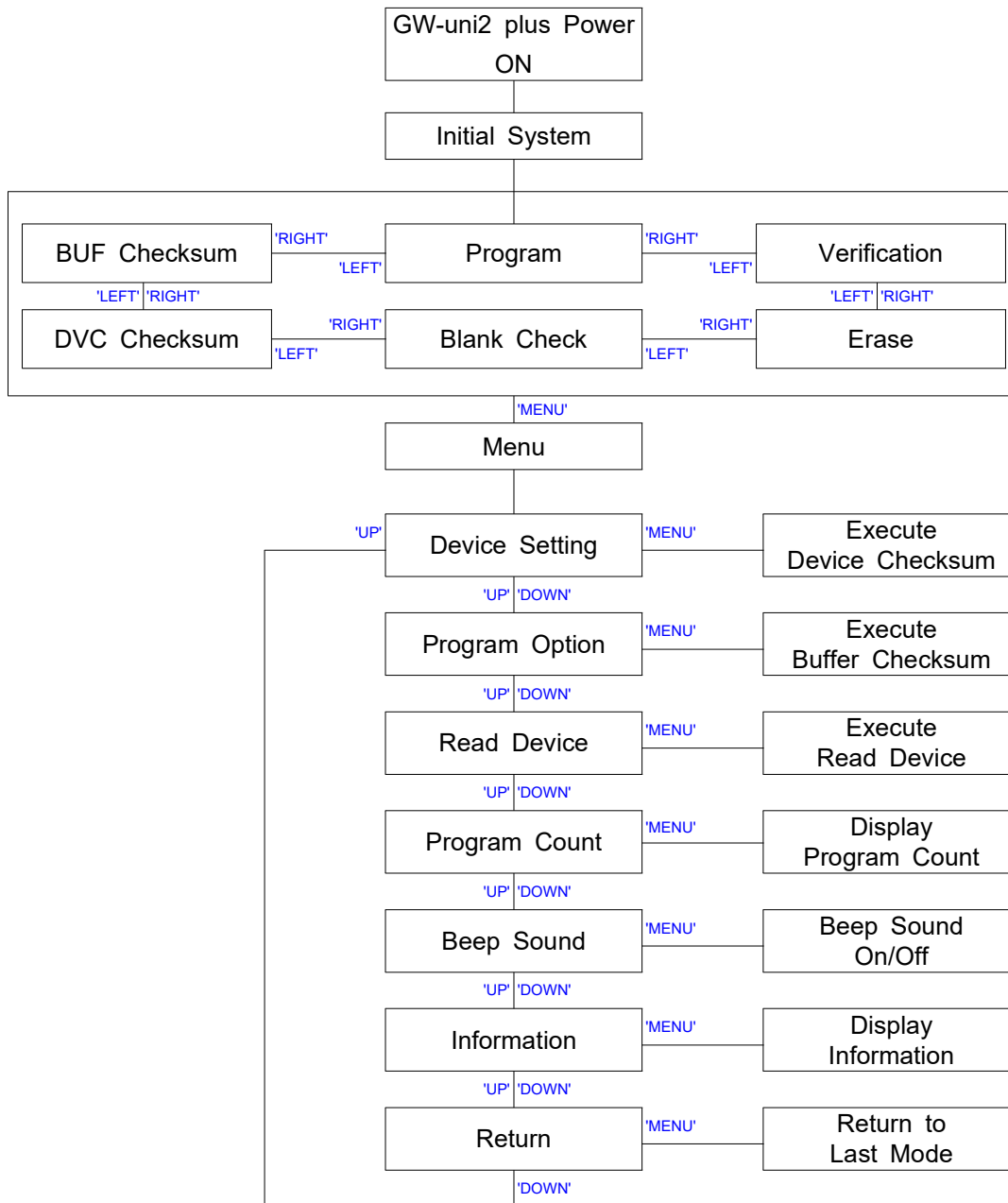

Figure 6.1 Key Function Map

* Please make sure that USB cable should not be connected when user want to use the stand-alone mode because 'Key' is not working when USB cable is connected.

7. In-System Program

7.1 UAS-Pellet2 Adapter Cable

: You must use a UAS-Pellet2 Adapter Cable when you use GW-uni2 plus to program

MCU(or COB) on the PCB.



Connect GW-uni2 plus to User board via UAS-Pellet2 Adapter Cable

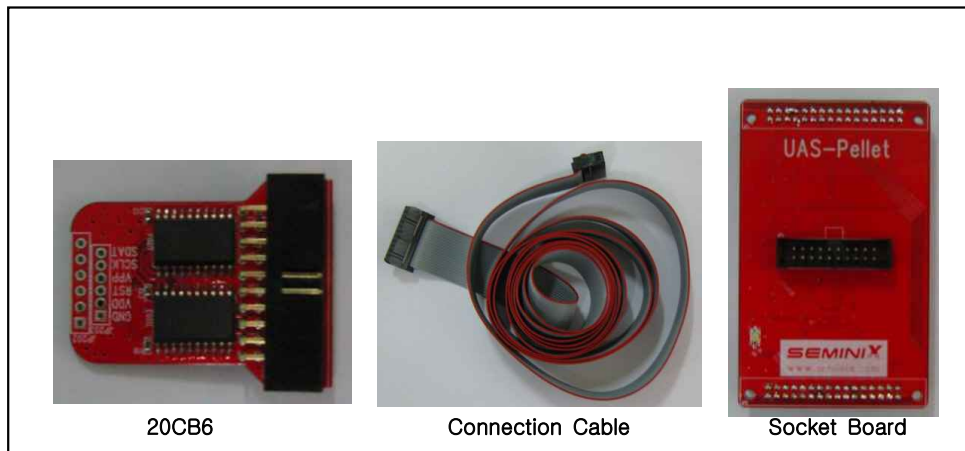

20CB6

Connection Cable

Socket Board

Figure 7.1 Component of UAS-pellet2 Adapter Cable

7.2 Connection

- (1) 20CB6-Adapter Board 'GND' – Target-MCU 'GND(Vss)'
- (2) 20CB6-Adapter Board 'VDD' – Target-MCU 'Vdd(Vcc)'
- (3) 20CB6-Adapter Board 'RST' – Target-MCU 'Reset'
- (4) 20CB6-Adapter Board 'VPP' – Target-MCU 'Vpp(Test)'
- * if 'Reset pin' and 'Vpp(Test) pin' are same, you have only to connect 'Vpp(Test) pin'.
- (5) 20CB6-Adapter Board 'SCLK' – Target-MCU 'SCLK'
- (6) 20CB6-Adapter Board 'SDAT' – Target-MCU 'SDATA'

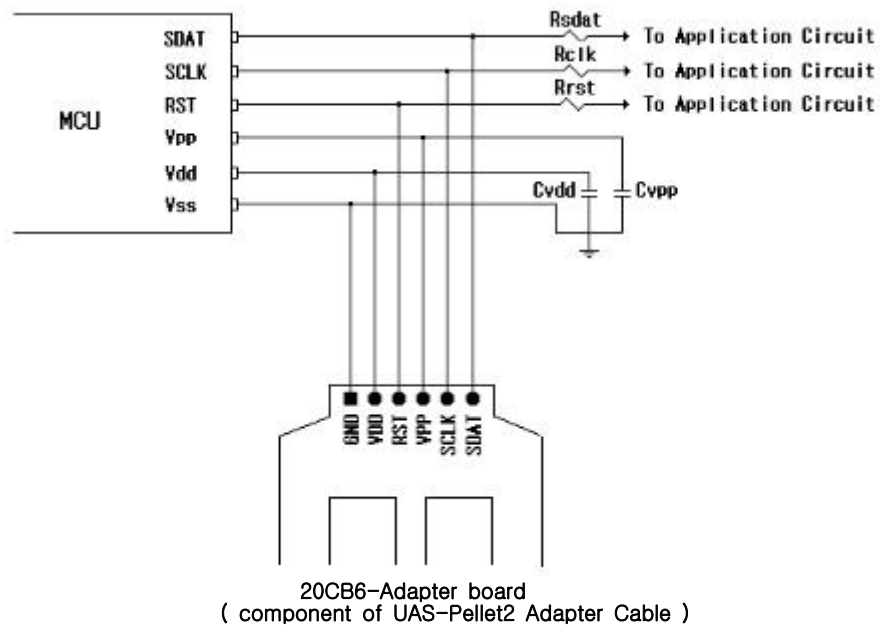

Figure 7.2 Connect UAS-Pellet2 Adapter Cable to MCU

Rsdnt : 4.7K ohm
 Rclk : 4.7K ohm
 Rrst : 1K~4.7K ohm
 Cvpp : 10nF
 Cvdd : 10nF

2) Connect UAS-Pellet2 Adapter to 20CB6 Adapter-Board via connect cable.

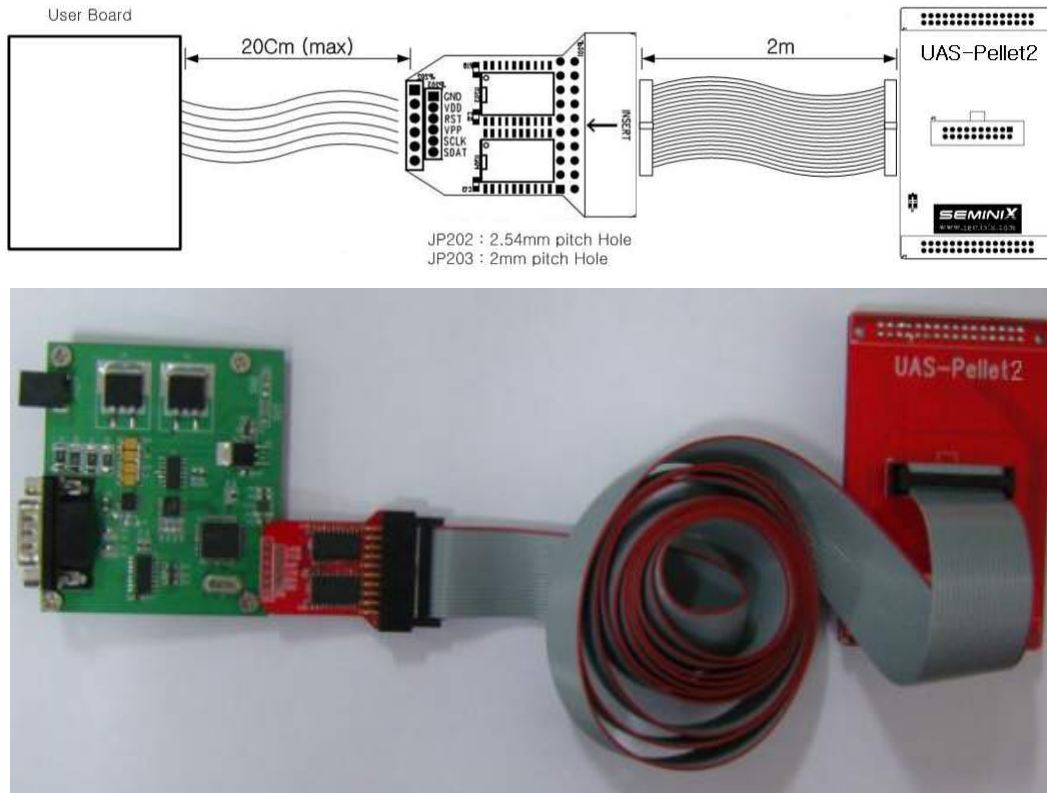

Figure 7.3 Connect UAS-Pellet2 Adapter cable to the User Board

3) Put a UAS-Pellet2 adapter cable in GW-uni2 plus.

7.3 Caution

- 1) 2m of cable is the maximum length from UAS-Pellet2 socket to 20CB6-Adapter Board
- 2) 20cm of cable is the maximum length from Adapter-Board to Target-MCU.
- 3) if you program to MCU on board, you must use the UAS-Pellet2 Adapter Cable.
- 4) Please check components – Rsdatt, Rclk, Rrst, Cvpp, Cvdd.

8. Electrical Characteristics

Parameter	Conditions		Min	Typ	Max	Unit
Current Consumption	Stand By		-	-130	-150	mA
	Operating		-	-	-300	
VDD	VPP 3.3 ~ 12.5		3.3		5.0	V
VPP	VDD 3.3 or 5.0		3.3		12.5	V
I _{dd}	VDD = 3.3V	VPP=3.3V	-	-	500	mA
		VPP=12.5V	-	-	500	mA
	VDD = 5.0V	VPP=5.0V	-	-	500	mA
		VPP=12.5V	-	-	500	mA
I _{pp}	VDD = 3.3V	VPP=3.3V	-	-	25	mA
		VPP=12.5V	-	-	25	mA
	VDD = 5.0V	VPP=5.0V	-	-	25	mA
		VPP=12.5V	-	-	25	mA

9. Special Notice

- 1) Please make sure to check device information, End address, V_{dd}, V_{pp}, buffer check sum before programming.
- 2) Please check device checksum regularly for normal programming
- 3) Please check V_{dd} and V_{pp} regularly
- 4) Please contact SEMINIX when there is a problem of device programming
- 5) GW-uni2 plus is the socket programmer only so SEMINIX can't take the responsibility for all accidents after user's artificial manipulation without SEMINIX socket
- 6) SEMINIX doesn't take the responsibility of GW-uni2 plus from user's careless mistake.

10. Socket Adapter Selection Guide

SAMSUNG S3F9xxx series adapter socket table

Device Name	Package type	Adapter socket
S3F94C4 S3F94C8	16SOP	UAS-94C4/8-16SOP
	16TSOP	UAS-94C4/8-16TSOP
	20DIP	UAS-94C4/8-20DIP
	20SOP	UAS-94C4/8-20SOP
	20SSOP	UAS-94C4/8-20SSOP

SAMSUNG S3F8xxx series adapter socket table

Device Name	Package type	Adapter socket
S3F80Q5	24ELP	UAS-80Q5-24ELP
S3F80QB	44ELP	UAS-80QB-44ELP
S3F80P5	24SOP	UAS-80P5-24SOP
	24SDIP	UAS-80P5-24SDIP
S3F80P9	28SOP	UAS-80P9-28SOP
S3F80PB	32SOP	UAS-80P9/B-32SOP
	44QFP	UAS-80P9/B-44QFP
S3F8285 S3F8289 S3F828B	80QFP	UAS-8285/9/B-80QFP
	80TQFP	UAS-8285/9/B-80TQFP
S3F84B8	20DIP	UAS-84B8-20DIP
	20SOP	UAS-84B8-20SOP
S3F84I9	42SDIP	UAS-84I9-42DIP
	44QFP	UAS-84I9-44QFP

SAMSUNG S3F8XXX series adapter socket table

Device Name	Package type	Adapter socket
S3F8S15 S3F8S19	48QFP	UAS-8S15/9-48QFP
	48TQFP	UAS-8S15/9-48TQFP
	48ELP	UAS-8S15/9-48ELP
S3F8S24 S3F8S28	24SOP	UAS-8S24/8-24SOP
	24TSSOP	UAS-8S24/8-24TSOP
	20DIP	UAS-8S24/8-20DIP
	20SOP	UAS-8S24/8-20SOP
	20SSOP	UAS-8S24/8-20SSOP

SAMSUNG S3F8XXX series adapter socket table

Device Name	Package type	Adapter socket
S3F8S34 S3F8S35 S3F8S38 S3F8S39	32SOP 32SDIP 32ELP	UAS-8S34/5/8/9-32SOP UAS-8S34/5/8/9-32SDIP UAS-8S34/5/8/9-32ELP
S3F8S45	44QFP	UAS-8S45-44QFP
S3F8S5A	44QFP	UAS-8S5A-44QFP
S3F8S6B	64QFP 64SDIP	UAS-8S6B-64QFP UAS-8S6B-64SDIP
S3F8S7B	80QFP 80TQFP	UAS-8S7B-80QFP UAS-8S7B-80TQFP
S3F8S8B	100QFP 100TQFP	UAS-8S8B-100QFP UAS-8S8B-100TQFP

SAMSUNG On-board Chip/COB type adapter cable

Device Name	Package type	Adapter socket
In-System Programing	Samsung Standard	UAS-Pellet2
COB (Chip On Board)	Pellet(Die form)	UAS-Pellet2

SAMSUNG CalmRISC16 (S3FCXXX) series adapter socket table

Device Name	Package type	Adapter socket
S3FC40D	100QFP 100TQFP 128QFP	UAS-C40D-100QFP UAS-C40D-100TQFP UAS-C40D-128QFP

SAMSUNG ARM7 series adapter socket table

Device Name	Package type	Adapter socket
S3F4A0K	144LQFP	UAS-4A0K-144LQFP
S3F4A1H	100TQFP	UAS-FA1H-100TQFP
S3F4A2F	80TQFP	UAS-4A2F-80TQFP
S3F401F	100QFP	UAS-401F-100QFP