

## Trench MOS Barrier Schottky Rectifier - 10Amp 60Volt

**Features**

- Plastic package has Underwriters Laboratory Flammability Classifications 94V-0
- High Junction Temperature Capability
- Low forward voltage, high current capability
- High surge capacity
- Low power loss, high efficiency
- Halogen-Free

**Application**

- AC/DC Switching Adaptor and other Switching Power Supply

**Absolute maximum ratings**

Symbol	Ratings	Unit	Conditions
IF(AV)	10	A	Average Forward Current
VRRM	60	V	Repetitive Peak Reverse Voltage
IFSM	120	A	Peak Forward Surge Current
VF	0.45	V	Forward Voltage Drop
Tj, Tstg	-65 to +150	°C	Operating and Storage Temperature

**Electrical characteristics**

Parameters	Symbol	Ratings		Conditions
		TYP.	MAX.	
Instantaneous Forward Voltage	VF			Per Leg at IF = 5A
		0.49V	0.52V	Tc = 25°C
		0.45V	0.48V	Tc = 125°C
Reverse Leakage Current	IR			Per Leg at VR = 60V
		0.2mA	0.5mA	Tc = 25°C
		30mA	100mA	Tc = 125°C
Typical Thermal Resistance, Junction to Case	Rθ(j-c)	2.2 °C/W		Per Leg
		4.5 °C/W		TO-220AB ITO-220AB

June 2015 / Rev.7.1

# MBR10V60CTH/FCTH

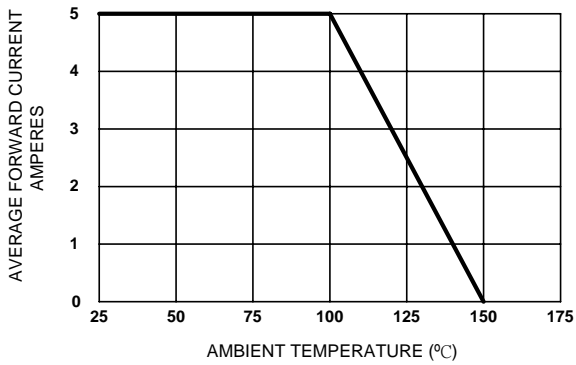

Figure 1. Forward Current Derating Curve

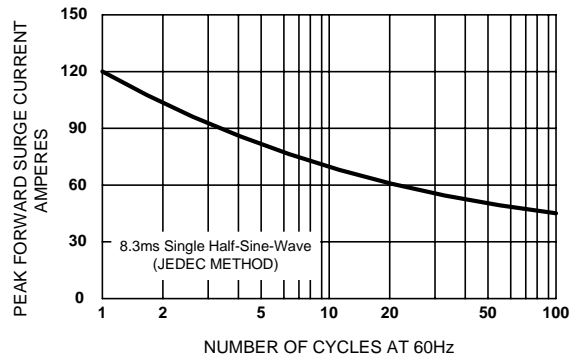

Figure 2. Maximum Non-repetitive Surge Current

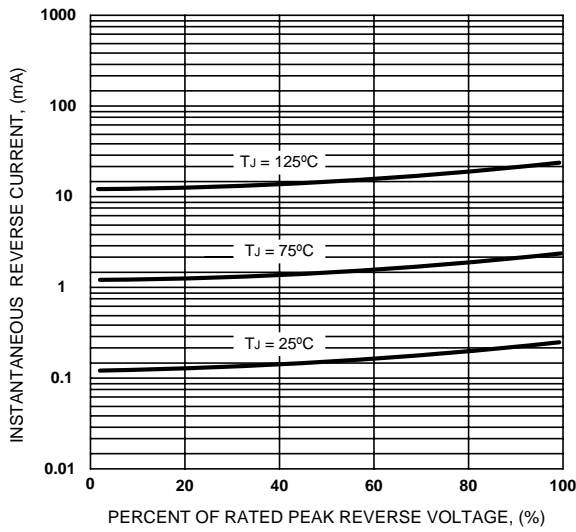

Figure 3. Typical Reverse Characteristics

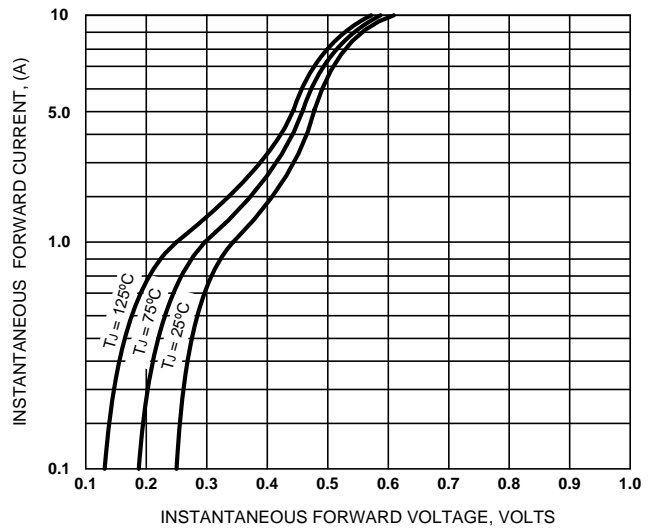

Figure 4. Typical Forward Characteristics

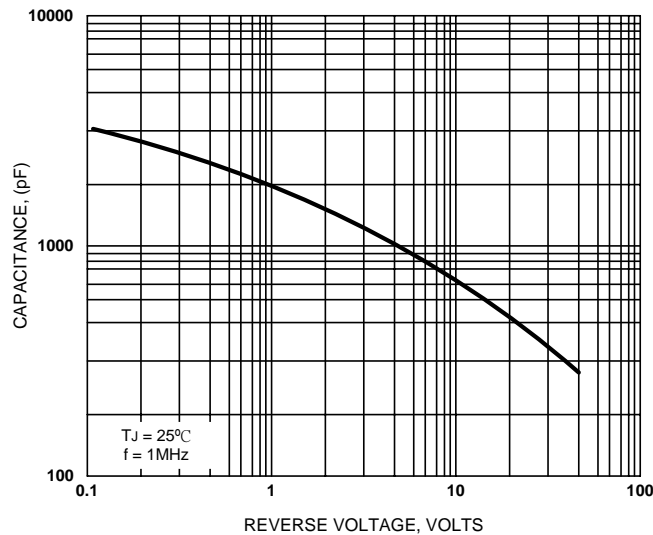
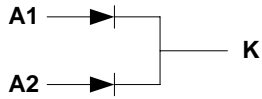
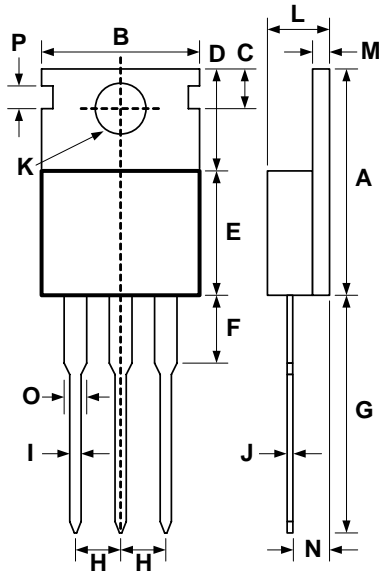

Figure 5. Typical Junction Capacitance

**MBR10V60CTH**

**TO-220AB**



DIM	DIMENSIONS				NOTE
	INCHES		MILLIMETERS		
	MIN	MAX	MIN	MAX	
A	.610	.630	15.5	16.00	
B	.390	.413	9.90	10.50	
C	.106	.126	2.70	3.20	
D	.228	.272	5.80	6.90	
E	.348	.372	8.85	9.45	
F	.102	.142	2.60	3.60	
G	.512	.551	13.00	14.00	
H	.093	.112	2.35	2.85	
I	.028	.037	0.70	0.95	
J	.016	.026	0.40	0.65	
K	.132	.152	3.35	3.85	
L	.169	.185	4.30	4.70	
M	.045	.057	1.15	1.45	
N	.089	.112	2.25	2.85	
O	.043	.055	1.10	1.40	
P	.055	.067	1.40	1.70	

**MBR10V60FCTH**

**ITO-220AB**

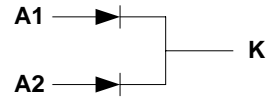
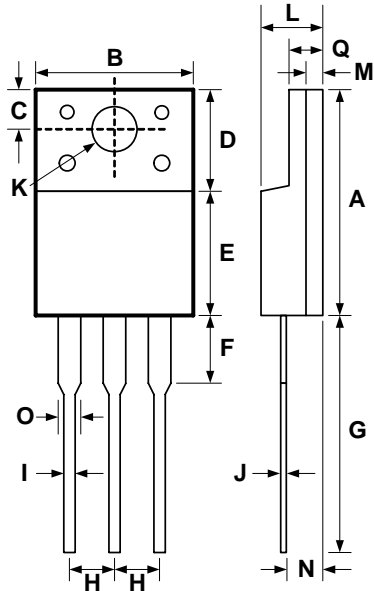

DIM	DIMENSIONS				NOTE
	INCHES		MILLIMETERS		
	MIN	MAX	MIN	MAX	
A	.585	.608	14.85	15.45	
B	.386	.410	9.80	10.40	
C	.100	.116	2.55	2.95	
D	.228	.272	5.80	6.90	
E	.327	.343	8.30	8.70	
F	.138	.177	3.50	4.50	
G	.512	.551	13.00	14.00	
H	.093	.112	2.35	2.85	
I	.020	.030	0.50	0.75	
J	.020	.030	0.50	0.75	
K	.120	.140	3.05	3.55	
L	.169	.185	4.30	4.70	
M	.039	.051	1.00	1.30	
N	.089	.112	2.25	2.85	
O	.043	.055	1.10	1.40	
Q	.114	.130	2.90	3.30	