

**Power Schottky Rectifier - 20Amp 200Volt**

**Features**

- Plastic package has Underwriters Laboratory Flammability Classifications 94V-0
- High Junction Temperature Capability
- Low forward voltage, high current capability
- High surge capacity
- Low power loss, high efficiency
- ESD performance human body mode > 4 KV

**Application**

- AC/DC Switching Adaptor and other Switching Power Supply
- PDP

**Absolute maximum ratings**

Symbol	Ratings	Unit	Conditions
IF(AV)	20	A	Average Forward Current
VRRM	200	V	Repetitive Peak Reverse Voltage
IFSM	150	A	Peak Forward Surge Current
VF	0.72	V	Forward Voltage Drop
Tj, Tstg	-50 to +175	°C	Operating and Storage Temperature

**Electrical characteristics**

Parameters	Symbol	Ratings	Conditions
Maximum Instantaneous Forward Voltage	VF	0.90V	Per Leg at IF = 10A Tc = 25°C
		0.72V	Tc = 125°C
Maximum Reverse Leakage Current	IR	0.05mA	Per Leg at VR = 200V Tc = 25°C
		10mA	Tc = 125°C
Typical Thermal Resistance, Junction to Case	Rθ(j-c)	2.2 °C/W	Per Leg TO-220AB / TO-262/ TO-263
		4.5 °C/W	ITO-220AB
		1.25 °C/W	TO-247AD
		1.1 °C/W	TO-3P

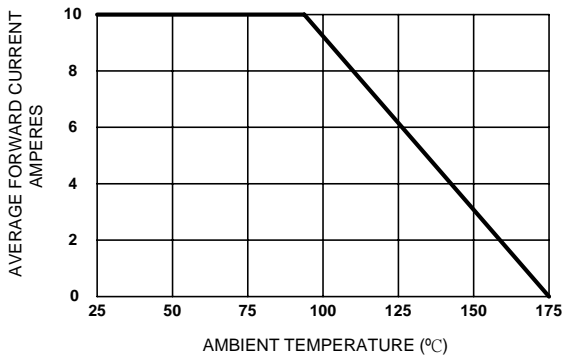

**Figure 1. Forward Current Derating Curve**

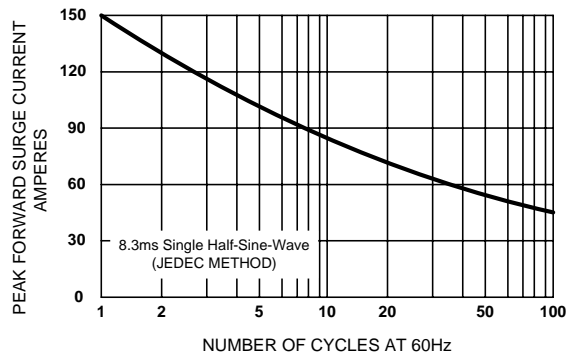

**Figure 2. Maximum Non-repetitive Surge Current**

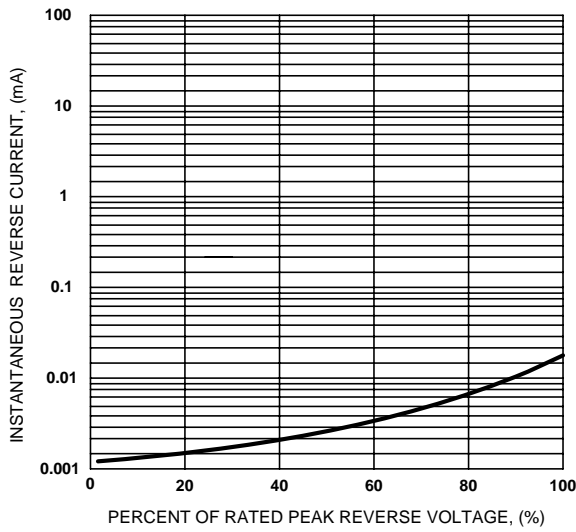

**Figure 3. Typical Reverse Characteristics**

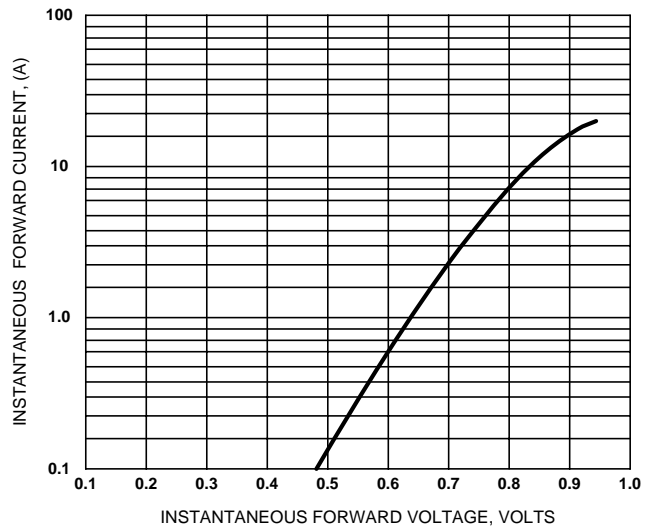

**Figure 4. Typical Forward Characteristics**

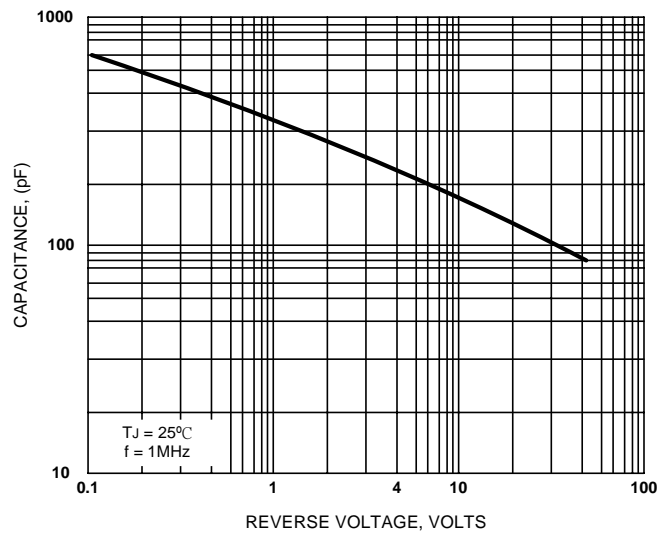

**Figure 5. Typical Junction Capacitance**

**MBR2020CT**

**TO-220AB**

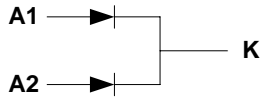
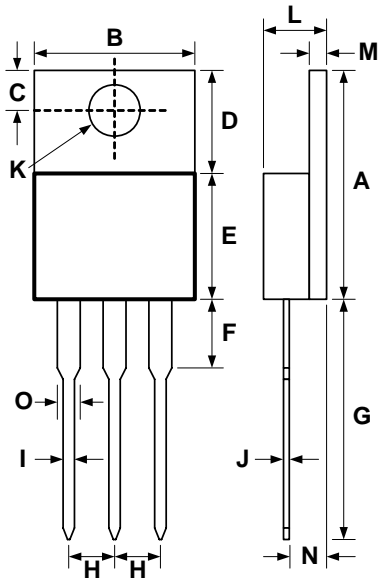

DIMENSIONS					
DIM	INCHES		MM		NOTE
	MIN	MAX	MIN	MAX	
A	.579	.606	14.70	15.40	
B	.392	.411	9.95	10.45	
C	.104	.116	2.65	2.95	
D	.248	.272	6.30	6.90	
E	.325	.350	8.25	8.90	
F	.126	.157	3.20	4.00	
G	.492	.551	12.50	14.00	
H	.096	.108	2.45	2.75	
I	.028	.039	0.70	1.00	
J	.010	.022	0.25	0.55	
K	.146	.157	3.70	4.00	
L	.167	.187	4.25	4.75	
M	.045	.057	1.15	1.45	
N	.089	.114	2.25	2.90	
O	.047	.055	1.20	1.40	

**MBR2020FCT**

**ITO-220AB**

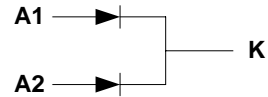
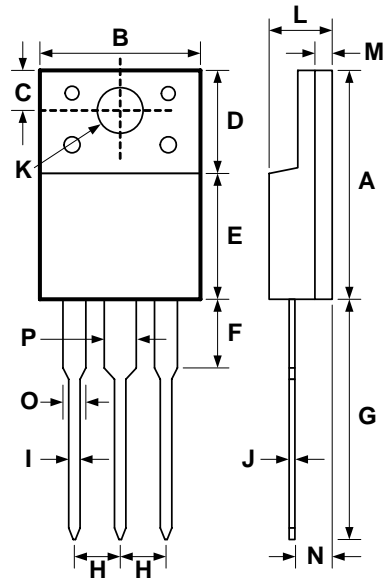

DIMENSIONS					
DIM	INCHES		MM		NOTE
	MIN	MAX	MIN	MAX	
A	.577	.640	14.65	16.25	
B	.386	.406	9.80	10.30	
C	.098	.114	2.50	2.90	
D	.258	.274	6.55	6.95	
E	.315	.331	8.00	8.40	
F	.079	.161	2.00	4.10	
G	.492	.571	12.50	14.50	
H	.089	.106	2.25	2.70	
I	.024	.035	0.60	0.90	
J	.020	.028	0.50	0.70	
K	.120	.138	3.05	3.50	
L	.169	.189	4.30	4.80	
M	.031	.063	0.80	1.60	
N	.079	.112	2.00	2.85	
O	.043	.055	1.10	1.40	
P	.047	.071	1.20	1.80	

**MBR20200CR**

**T0-262**

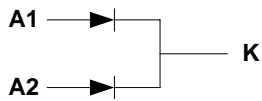
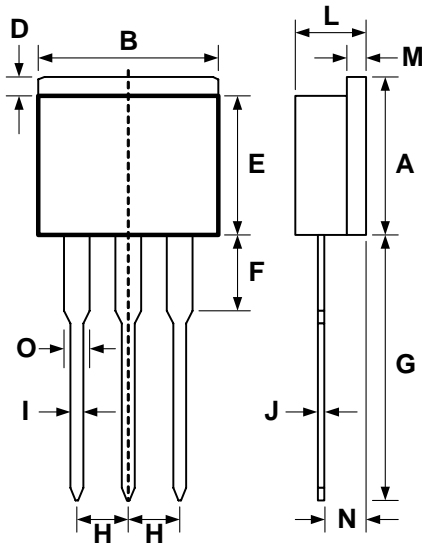

DIM	DIMENSIONS				NOTE
	INCHES		MM		
	MIN	MAX	MIN	MAX	
A	.370	.397	9.40	10.10	
B	.392	.411	9.95	10.45	
D	.050	.055	1.27	1.40	
E	.325	.350	8.25	8.90	
F	.126	.138	3.20	3.50	
G	.492	.551	12.50	14.00	
H	.096	.108	2.45	2.75	
I	.028	.039	0.70	1.00	
J	.010	.022	0.25	0.55	
L	.167	.187	4.25	4.75	
M	.045	.057	1.15	1.45	
N	.089	.114	2.25	2.90	
O	.047	.055	1.20	1.40	

**MBR20200CG**

**T0-263**

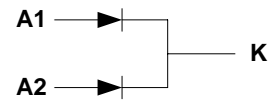
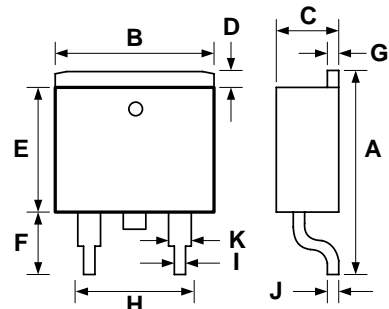

DIM	DIMENSIONS				NOTE
	INCHES		MM		
	MIN	MAX	MIN	MAX	
A	.575	.624	14.60	15.85	
B	.380	.420	9.65	10.65	
C	.159	.191	4.05	4.85	
D	.039	.067	1.00	1.70	
E	.329	.380	8.35	9.65	
F	.197	.216	5.00	5.50	
G	.045	.065	1.15	1.65	
H	.195	.205	4.95	5.20	
I	.020	.039	0.50	1.00	
J	.013	.029	0.35	0.75	
K	.047	.055	1.20	1.40	

# MBR20200PT

## T0-247AD

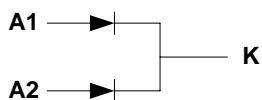
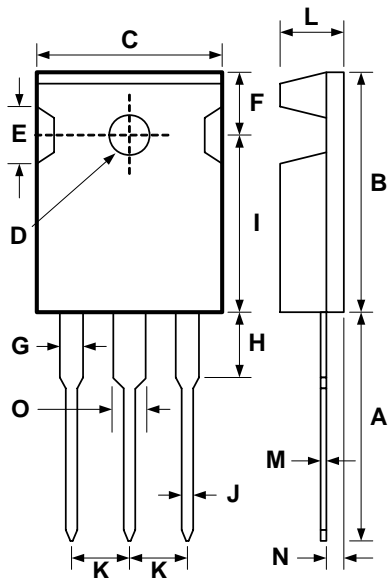

DIM	INCHES		MM		NOTE
	MIN	MAX	MIN	MAX	
A	.748	.827	19.00	21.00	
B	.787	.866	20.00	22.00	
C	.598	.638	15.20	16.20	
D	.130	.150	3.30	3.80	
E	.205	.242	5.20	6.15	
F	.209	.232	5.30	5.90	
G	.077	.091	1.95	2.30	
H	.161	.189	4.10	4.80	
I	.551	.610	14.00	15.50	
J	.045	.055	1.15	1.40	
K	.197	.219	5.00	5.55	
L	.189	.205	4.80	5.20	
M	.020	.031	0.50	0.80	
N	.083	.094	2.10	2.40	
O	.116	.128	2.95	3.25	

# MBR20200PT

## T0-3P

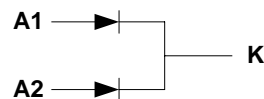
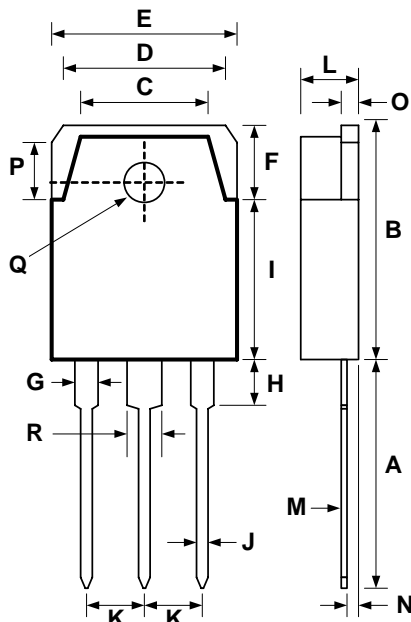

DIM	INCHES		MM		NOTE
	MIN	MAX	MIN	MAX	
A	.744	.783	18.90	19.90	
B	.787	.827	20.00	21.00	
C	.346	.386	8.80	9.80	
D	.512	.535	13.00	13.60	
E	.602	.628	15.30	15.95	
F	.256	.276	6.50	7.00	
G	.077	.085	1.95	2.15	
H	.098	.126	2.50	3.20	
I	.528	.551	13.40	14.00	
J	.035	.047	0.90	1.20	
K	.205	.220	5.20	5.60	
L	.183	.195	4.65	4.95	
M	.022	.035	0.55	0.90	
N	.053	.059	1.35	1.50	
O	.055	.065	1.40	1.65	
P	.165	.197	4.20	5.00	
Q	.128	.140	3.25	3.55	
R	.114	.130	2.90	3.30	