

H-Series

CIRCUIT BREAKER

The H-Series hydraulic-magnetic circuit breaker provides maximum and dependable circuit protection, while providing a cost effective, compact solution. By meeting the IEC spacing requirements, the H-Series is the ideal choice for international market applications. It also features a “trip-free” mechanism, which will open the contacts when a fault condition occurs, even if the handle is held in the ON position.

1-3 poles; 1-35 amps; 65VDC, 80VDC, 250VAC; UL recognized, CSA accepted, TUV & CCC certified.



Resources:

[Download 3D CAD Files](#)

[IGS >](#)

[STP >](#)

Product Highlights:

- Choice of actuator styles
- UL1077, CCC, CSA, C22.2 and EN60934 approvals
- Compact size
- Temperature stable operation -40° C to +80° C
- Choice of terminals, including PCB
- Single or multi-pole configurations

Typical Applications:

- Telecom/Datacom
- Marine



Carling Technologies®

Innovative Designs. Powerful Solutions.

Carling Technologies, Inc.
60 Johnson Avenue, Plainville, CT 06062
Email: sales@carlingtech.com
Application Support: team2@carlingtech.com
Phone: 860.793.9281 Fax: 860.793.9231

www.carlingtech.com

Electrical Tables

Table A: Lists UL Recognized, CSA Accepted and TUV Certified configurations and performance capabilities as a Component Supplementary Protector.

H-SERIES: COMPONENT SUPPLEMENTARY PROTECTORS										
Circuit Configuration	Voltage			Current Rating	Minimum Poles	Short Circuit Capacity (Amps)			Application Codes	
	Max Rating	Frequency	Phase	Full Load Amps		UL	CSA	TUV	UL	CSA
						Without Backup Fuse	Without Backup Fuse	(Icn) Without Backup Fuse		
Series	65	DC	---	1 - 25	1	3000	3000	3000	TC1, OL1, U1	TC1, OL1, U1
	65	DC	---	26 - 35	1	3000	3000	3000	TC1, OL1, U3	TC1, OL1, U3
	80	DC	---	1 - 25	1	1000	1000	1000	TC1, OL1, U1	TC1, OL1, U1
	80 ¹	DC	---	26 - 35	1	1000	1000	1000	TC1, OL1, U3	TC1, OL1, U3
	250	50 / 60	1	1 - 35	1	1500	1500	500	TC1, OL1, U1	TC1, OL1, U3
	250	50 / 60	1	1 - 35	2	1500	1500	500	TC1, OL1, U3	TC1, OL1, U3
	250	50 / 60	3	1 - 35	3	1500	1500	500	TC1, OL0, U3	TC1, OL0, U3

Notes:

¹ Polarity Sensitive

Electrical

Maximum Voltage 250VAC 50/60Hz 80 VDC
 Current Ratings Standard current coils: 1.00, 2.50, 5.00, 7.50, 10.0, 15.0, 20.0, 25.0, 30.0, 32.0, 35.0
 SPDT: 10.1A-250VAC,
 Auxiliary Switch Rating 1.0A-65VDC/0.5A-80VDC, 0.1A-125VAC (with gold contacts)

Mechanical

Endurance 10,000 ON-OFF operations @ 6 per minute; with rated current & voltage

Physical

Number of Poles 1-3
 Weight Approx. 48 grams/pole (1.7 oz)
 Internal Circuit Config. Series and Switch Only (with or without auxiliary switch)

Agency Approvals

UL Recognized under the Component Recognition Program as Protectors, Supplementary (Guide QVNU2 File E75596)
 UL standard 1077

CCC certified, Certificate No. 2010010307447291

CSA Accepted Supplementary Protector
 CSA standard C22.2 No. 235

TUV certified to EN60934, Certificate No. R50204086

Typical Protector Resistance

DCR and Impedance values are based on measurements by the voltmeter ammeter method. Rated current is applied for one hour at a voltage not less than 20 volts. Ambient temperature: 25 °C; Tolerance: Below 10 amps +/- 25%; Above 10 amps +/-35%

Impedance Chart

Current Rating (Amps)	Series	
	DC-Ohms	50/60Hz-Ohms
1	0.85	0.87
2.5	0.13	0.15
5	0.035	0.036
7.5	0.018	0.019
10	0.010	0.011
15	0.006	0.0061
20	0.005	0.0051
25	0.003	0.0035
30	0.0025	0.0026
35	0.0021	0.0022

*Manufacturer reserves the right to change product specification without prior notice.



1 Series 2 Actuator 3 Poles 4 Circuit 5 Aux/Alarm Switch 6 Frequency & Delay 7 Current Rating 8 Terminal 9 Actuator Color & Legend 10 Mounting Bezel/Barrier 11 Rating 12 Agency Approval

1 SERIES
H

2 ACTUATOR 1
A Handle, one per pole B Handle, one per unit

3 POLE 2
1 One 2 Two 3 Three

4 CIRCUIT
A Switch Only (no coil) C⁴ Series Trip (voltage)
B Series Trip (current) G⁴ Relay Trip (voltage)

5 AUXILIARY / ALARM SWITCH
0 without Aux Switch 3³ 0.110 Q.C. term with gold contacts
1³ 0.110 Q.C. term 4³ 0.110 PC term
2³ 0.110 Solder Lug

6 FREQUENCY & DELAY
03³ DC 50/60HZ, Switch Only 30 DC, 50/60Hz, Instantaneous
10 DC, Instantaneous 31 DC, 50/60Hz, Ultra Short
11 DC, Ultra Short 32 DC, 50/60Hz, Short
12 DC, Short 34 DC, 50/60Hz, Medium
14 DC, Medium 36 DC, 50/60Hz, Long
16 DC, Long 42⁴ 50/60 Hz Hi-Inrush Short
20 50/60 Hz Instantaneous 44⁴ 50/60 Hz Hi-Inrush Medium
21 50/60 Ultra Short 46⁴ 50/60 Hz Hi-Inrush Long
22 50/60 Hz Short 52⁴ DC Hi-Inrush Short
24 50/60 Hz Medium 54⁴ DC Hi-Inrush Medium
26 50/60 Hz Long 56⁴ DC Hi-Inrush Long

7 CURRENT RATING (AMPERES) 5

CODE	AMPERES						
410	1.00	445	4.50	610	10.00	618	18.00
512	1.25	450	5.00	710	10.50	620	20.00
415	1.50	455	5.50	611	11.00	622	22.00
517	1.75	460	6.00	711	11.50	624	24.00
420	2.00	465	6.50	612	12.00	625	25.00
522	2.25	470	7.00	712	12.50	630	30.00
425	2.50	475	7.50	613	13.00	632	32.00
527	2.75	480	8.00	614	14.00	635	35.00
430	3.00	485	8.50	615	15.00		
435	3.50	490	9.00	616	16.00		
440	4.00	495	9.50	617	17.00		

VOLTAGE RATING

CODE	RATING	TRIP VOLTS					
A06	6DC	5DC	A65	65DC	55DC	J65	65AC 55AC
A12	12DC	10DC	J06	6AC	5AC	K20	120AC 65AC
A18	18DC	15DC	J12	12AC	10AC	L40	240AC 130AC
A24	24DC	20DC	J18	18AC	15AC	B10	110DC 59DC
A32	32DC	25DC	J24	24AC	20AC	B20	120DC 65DC
A48	48DC	40DC	J48	48AC	40AC		

8 TERMINAL 6

		Printed Circuitboard Terminals
1	Push ON 0.250 Tab (Q.C.)	L 90 Facing Left
2	Screw 8-32 with upturned lugs	R 90 Facing Right
3	Screw 8-32 (bus type)	S Straight
A	Screw M4 with upturned lugs	T Straight, Long
B	Screw M4 (bus type)	

9 ACTUATOR COLOR & LEGEND

Actuator Color	I-O	ON-OFF	Dual	Legend Color
White	A	B	1	Black
Black	C	D	2	White
Red	F	G	3	White
Green	H	J	4	White
Blue	K	L	5	White
Yellow	M	N	6	Black
Gray	P	Q	7	Black
Orange	R	S	8	Black

10 MOUNTING / BARRIERS

	MOUNTING STYLE	BARRIERS	BEZEL	
	Threaded Insert			
1	6-32 x 0.195 inches	no	domed	
A	6-32 x 0.195 inches	yes	domed	
2	ISO M3 x 5mm	no	domed	
B	ISO M3 x 5mm	yes	domed	
3	6-32 x 0.195 inches	no	flat	
C	6-32 x 0.195 inches	yes	flat	
4	ISO M3 x 5mm	no	flat	
D	ISO M3 x 5mm	yes	flat	

11 MAX. APPLICATION RATING

A	65VDC
D	250VAC
M ⁶	80VDC
4 ⁷	80VDC / 250VAC

12 AGENCY APPROVAL

A	Without approvals
C	UL Recognized, CSA Accepted
E	UL Recognized, CSA Accepted, TUV Certified
5	UL Recognized, CSA Accepted, TUV Certified, CCC Certified

Notes:

- Actuator Option A: handle tie pin, spacer & retainers provided unassembled on multipole units.
Actuator Option B: Handle location as viewed from front of panel: 2 pole: left pole; 3 pole: center pole
- Standard multipole units have all poles identical, except when specifying auxiliary switch
- Auxiliary switch available on Series Trip and Switch Only circuits to 32A. On multipole units, only one auxiliary switch is normally supplied, mounted in extreme right pole.
- Separate Pole Type Voltage Coils not rated for continuous duty. Available only with delay code 10 & 20. Only Available with Agency code C.
For other current ratings, consult factory.
- 26-35A Polarity sensitive, only available as 1 pole unit.
- Voltage code 4 available to 25A max.

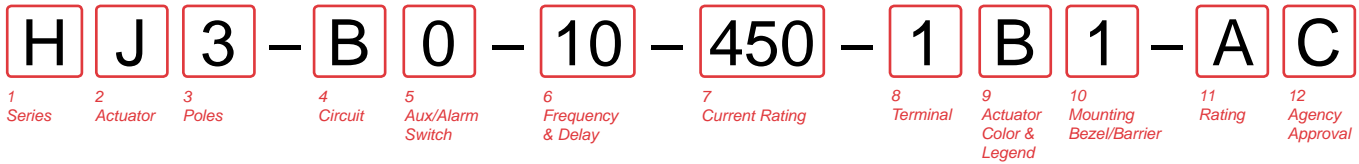

1 SERIES (VISI ROCKER)
H

2 ACTUATOR 1
J Vertical - Indicator OFF K Vertical - Indicator ON

3 POLE 2
1 One 2 Two 3 Three

4 CIRCUIT
A Switch Only (no coil) C⁴ Series Trip (voltage)
B Series Trip (current) G⁴ Relay Trip (voltage)

5 AUXILIARY / ALARM SWITCH
0 without Aux Switch 3³ 0.110 Q.C. term with gold contacts
1³ 0.110 Q.C. term 4³ 0.110 PC term
2³ 0.110 Solder Lug

6 FREQUENCY & DELAY

03 ³ DC 50/60HZ, Switch Only	30 DC, 50/60Hz, Instantaneous
10 DC, Instantaneous	31 DC, 50/60Hz, Ultra Short
11 DC, Ultra Short	32 DC, 50/60Hz, Short
12 DC, Short	34 DC, 50/60Hz, Medium
14 DC, Medium	36 DC, 50/60Hz, Long
16 DC, Long	42 ⁴ 50/60 Hz Hi-Inrush Short
20 50/60 Hz Instantaneous	44 ⁴ 50/60 Hz Hi-Inrush Medium
21 50/60 Ultra Short	46 ⁴ 50/60 Hz Hi-Inrush Long
22 50/60 Hz Short	52 ⁴ DC Hi-Inrush Short
24 50/60 Hz Medium	54 ⁴ DC Hi-Inrush Medium
26 50/60 Hz Long	56 ⁴ DC Hi-Inrush Long

7 CURRENT RATING (AMPERES) 5

CODE	AMPERES				
410	1.00	445	4.50	610	10.00
512	1.25	450	5.00	710	10.50
415	1.50	455	5.50	611	11.00
517	1.75	460	6.00	711	11.50
420	2.00	465	6.50	612	12.00
522	2.25	470	7.00	712	12.50
425	2.50	475	7.50	613	13.00
527	2.75	480	8.00	614	14.00
430	3.00	485	8.50	615	15.00
435	3.50	490	9.00	616	16.00
440	4.00	495	9.50	617	17.00

VOLTAGE RATING

CODE	RATING	TRIP VOLTS			
A06	6DC	5DC	A65	65DC	55DC
A12	12DC	10DC	J06	6AC	5AC
A18	18DC	15DC	J12	12AC	10AC
A24	24DC	20DC	J18	18AC	15AC
A32	32DC	25DC	J24	24AC	20AC
A48	48DC	40DC	J48	48AC	40AC
			J65	65AC	55AC
			K20	120AC	65AC
			L40	240AC	130AC
			B10	110DC	59DC
			B20	120DC	65DC

8 TERMINAL

1 Push ON 0.250 Tab (Q.C.)		Printed Circuitboard Terminals
2 Screw 8-32 with upturned lugs	L	90 Facing Left
3 Screw 8-32 (bus type)	R	90 Facing Right
A Screw M4 with upturned lugs	S	Straight
B Screw M4 (bus type)	T	Straight, Long

9 ACTUATOR COLOR & LEGEND

Actuator Color	I-O	ON-OFF	Dual
White	A	B	1
Black	C	D	2
Red	F	G	3
Green	H	J	4
Blue	K	L	5
Yellow	M	N	6
Gray	P	Q	7
Orange	R	S	8

10 MOUNTING / BARRIERS 6

	MOUNTING STYLE	BARRIERS	HALF ROCKER GUARD	BRACKET COLOR
	Threaded Insert			
1	6-32 x 0.195 inches	no	no	Black
A	6-32 x 0.195 inches	yes	no	Black
2	ISO M3 x 5mm	no	no	Black
B	ISO M3 x 5mm	yes	no	Black
3	6-32 x 0.195 inches	no	yes	Black
C	6-32 x 0.195 inches	yes	yes	Black
4	ISO M3 x 5mm	no	yes	Black
D	ISO M3 x 5mm	yes	yes	Black
5	6-32 x 0.195 inches	no	no	White
E	6-32 x 0.195 inches	yes	no	White
6	ISO M3 x 5mm	no	no	White
F	ISO M3 x 5mm	yes	no	White
7	6-32 x 0.195 inches	no	yes	White
G	6-32 x 0.195 inches	yes	yes	White
8	ISO M3 x 5mm	no	yes	White
H	ISO M3 x 5mm	yes	yes	White
9	6-32 x 0.195 inches	no	no	Gray
J	6-32 x 0.195 inches	yes	no	Gray
P	ISO M3 x 5mm	no	no	Gray
K	ISO M3 x 5mm	yes	no	Gray
Q	6-32 x 0.195 inches	no	yes	Gray
L	6-32 x 0.195 inches	yes	yes	Gray
U	ISO M3 x 5mm	no	yes	Gray
M	ISO M3 x 5mm	yes	yes	Gray

11 MAX. APPLICATION RATING

A	65VDC
D	250VAC
M ⁷	80VDC
4 ⁸	80VDC / 250VAC

12 AGENCY APPROVAL

A	Without approvals
C	UL Recognized, CSA Accepted
E	UL Recognized, CSA Accepted, TUV Certified
5	UL Recognized, CSA Accepted, TUV Certified, CCC Certified

- Notes:
- Half guard construction have OFF protection for actuator
 - Standard multipole units have all poles identical, except when specifying auxiliary switch
 - Auxiliary switch available on Series Trip and Switch Only circuits to 32A. On multipole units, only one auxiliary switch is normally supplied, mounted in extreme right pole.
 - Separate Pole Type Voltage Coils not rated for continuous duty. Available only with delay code 10 & 20. Only Available with Agency code C.
 - For other current ratings, consult factory.
 - On Visi-Rocker, Visi portion of rocker cannot be the same color as the bezel. Remainder of rocker same color as bezel.
 - 26-35A Polarity sensitive, only available as 1 pole unit.
 - Voltage code 4 available to 25A max.

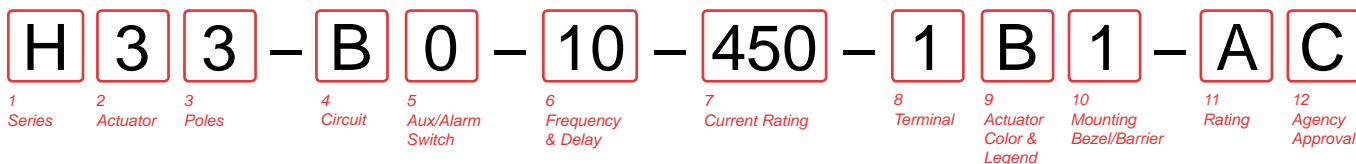

1 SERIES
H

2 ACTUATOR 1
3 Single Color Vertical 7 Push-to-Reset, Single Color Vertical
4 Single Color Horizontal 8 Push-to-Reset, Single Color Horizontal

3 POLE 2
1 One 2 Two 3 Three

4 CIRCUIT
A Switch Only (no coil) C⁴ Series Trip (voltage)
B Series Trip (current) G⁴ Relay Trip (voltage)

5 AUXILIARY / ALARM SWITCH
0 without Aux Switch 3³ 0.110 Q.C. term with gold contacts
1³ 0.110 Q.C. term 4³ 0.110 PC term
2³ 0.110 Solder Lug

6 FREQUENCY & DELAY
03³ DC 50/60HZ, Switch Only 30 DC, 50/60Hz, Instantaneous
10 DC, Instantaneous 31 DC, 50/60Hz,Ultra Short
11 DC, Ultra Short 32 DC, 50/60Hz, Short
12 DC, Short 34 DC, 50/60Hz, Medium
14 DC, Medium 36 DC, 50/60Hz, Long
16 DC, Long 42⁴ 50/60 Hz Hi-Inrush Short
20 50/60 Hz Instantaneous 44⁴ 50/60 Hz Hi-Inrush Medium
21 50/60 Ultra Short 46⁴ 50/60 Hz Hi-Inrush Long
22 50/60 Hz Short 52⁴ DC Hi-Inrush Short
24 50/60 Hz Medium 54⁴ DC Hi-Inrush Medium
26 50/60 Hz Long 56⁴ DC Hi-Inrush Long

7 CURRENT RATING (AMPERES) 5

CODE	AMPERES						
410	1.00	445	4.50	610	10.00	618	18.00
512	1.25	450	5.00	710	10.50	620	20.00
415	1.50	455	5.50	611	11.00	622	22.00
517	1.75	460	6.00	711	11.50	624	24.00
420	2.00	465	6.50	612	12.00	625	25.00
522	2.25	470	7.00	712	12.50	630	30.00
425	2.50	475	7.50	613	13.00	632	32.00
527	2.75	480	8.00	614	14.00	635	35.00
430	3.00	485	8.50	615	15.00		
435	3.50	490	9.00	616	16.00		
440	4.00	495	9.50	617	17.00		

VOLTAGE RATING

CODE	RATING	TRIP VOLTS						
A06	6DC	5DC	A65	65DC	55DC	J65	65AC	55AC
A12	12DC	10DC	J06	6AC	5AC	K20	120AC	65AC
A18	18DC	15DC	J12	12AC	10AC	L40	240AC	130AC
A24	24DC	20DC	J18	18AC	15AC	B10	110DC	59DC
A32	32DC	25DC	J24	24AC	20AC	B20	120DC	65DC
A48	48DC	40DC	J48	48AC	40AC	X01	65AC	<small>special catalog #</small>

8 TERMINAL
1 Push ON 0.250 Tab (Q.C.) **Printed Circuitboard Terminals**
2 Screw 8-32 with upturned lugs L 90 Facing Left
3 Screw 8-32 (bus type) R 90 Facing Right
A Screw M4 with upturned lugs S Straight
B Screw M4 (bus type) T Straight, Long

9 ACTUATOR COLOR & LEGEND

Actuator Color	I-O	ON-OFF	Dual	Legend Color
White	A	B	1	Black
Black	C	D	2	White
Red	F	G	3	White
Green	H	J	4	White
Blue	K	L	5	White
Yellow	M	N	6	Black
Gray	P	Q	7	Black
Orange	R	S	8	Black

10 MOUNTING / BARRIERS 6

MOUNTING STYLE	BARRIERS	HALF ROCKER GUARD	BRACKET COLOR
Threaded Insert			
1 6-32 x 0.195 inches	no	no	Black
A 6-32 x 0.195 inches	yes	no	Black
2 ISO M3 x 5mm	no	no	Black
B ISO M3 x 5mm	yes	no	Black
3 6-32 x 0.195 inches	no	yes	Black
C 6-32 x 0.195 inches	yes	yes	Black
4 ISO M3 x 5mm	no	yes	Black
D ISO M3 x 5mm	yes	yes	Black
5 6-32 x 0.195 inches	no	no	White
E 6-32 x 0.195 inches	yes	no	White
6 ISO M3 x 5mm	no	no	White
F ISO M3 x 5mm	yes	no	White
7 6-32 x 0.195 inches	no	yes	White
G 6-32 x 0.195 inches	yes	yes	White
8 ISO M3 x 5mm	no	yes	White
H ISO M3 x 5mm	yes	yes	White
9 6-32 x 0.195 inches	no	no	Gray
J 6-32 x 0.195 inches	yes	no	Gray
P ISO M3 x 5mm	no	no	Gray
K ISO M3 x 5mm	yes	no	Gray
Q 6-32 x 0.195 inches	no	yes	Gray
L 6-32 x 0.195 inches	yes	yes	Gray
U ISO M3 x 5mm	no	yes	Gray
M ISO M3 x 5mm	yes	yes	Gray

11 MAX. APPLICATION RATING
A 65VDC
D 250VAC
M⁷ 80VDC
4⁸ 80VDC / 250VAC

12 AGENCY APPROVAL
A Without approvals
C UL Recognized, CSA Accepted
E UL Recognized, CSA Accepted, TUV Certified
5 UL Recognized, CSA Accepted, TUV Certified, CCC Certified

Notes:
1 Push-To-Reset actuator shave OFF portion of rocker shrouded
2 Standard multipole units have all poles identical, except when specifying auxiliary switch
3 Auxiliary switch available on Series Trip and Switch Only circuits to 32A. On multipole units, only one auxiliary switch is normally supplied, mounted in extreme right pole
4 Separate Pole Type Voltage Coils not rated for continuous duty. Available only with delay code 10 & 20. Only Available with Agency code C.
5 For other current ratings, consult factory.
6 On Visi-Rocker,Visi portion of rocker cannot be the same color as the bezel. Remainder of rocker same color as bezel.
7 26-35A Polarity sensitive, only available as 1 pole unit.
8 Voltage code 4 available to 25A max.

Dimensional Specifications: in. [mm]

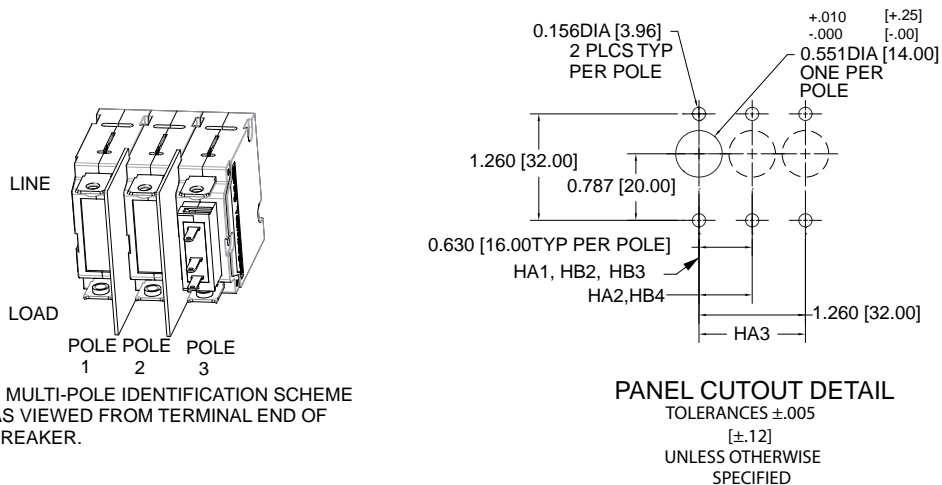
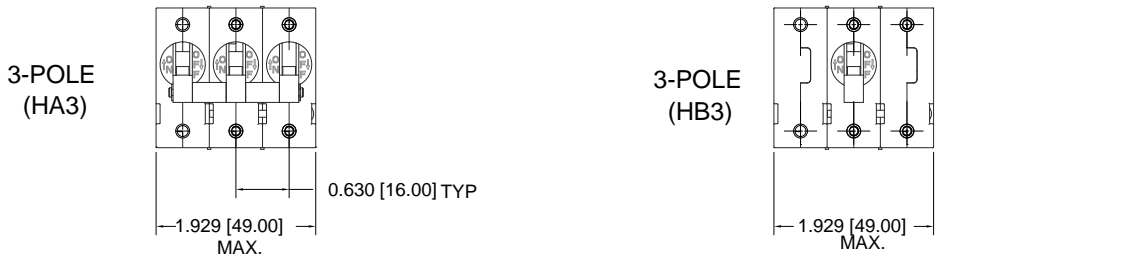
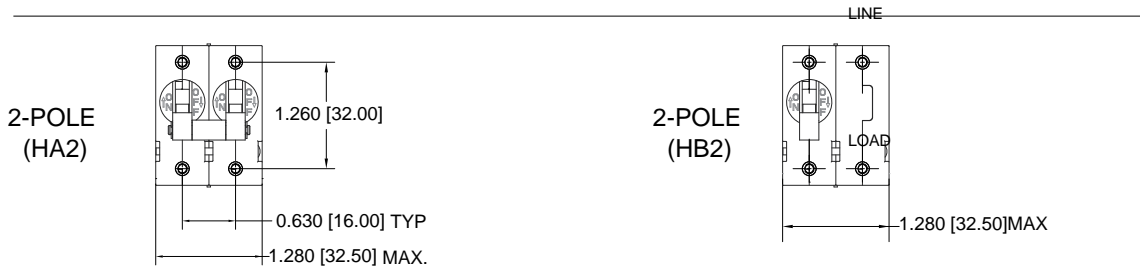
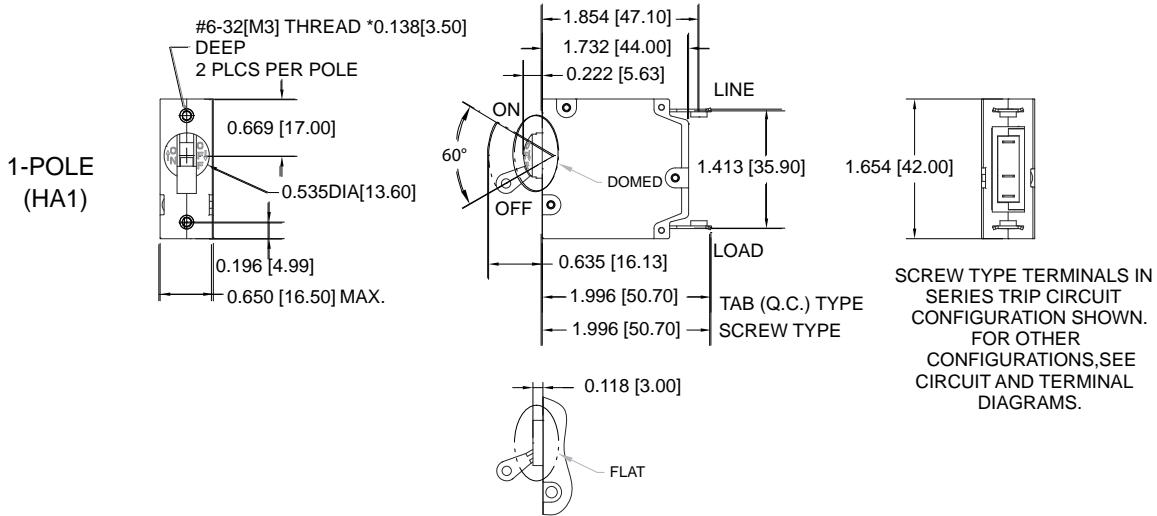

Notes:
1 All dimensions are in inches [millimeters].
2 Tolerance ±.020 [51] unless otherwise specified.

Dimensional Specifications: in. [mm]

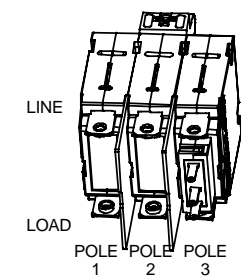
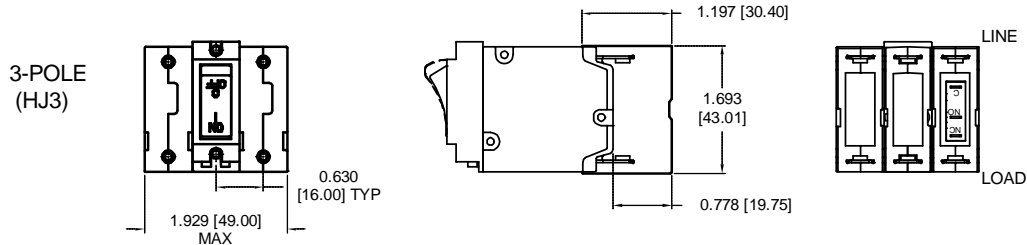
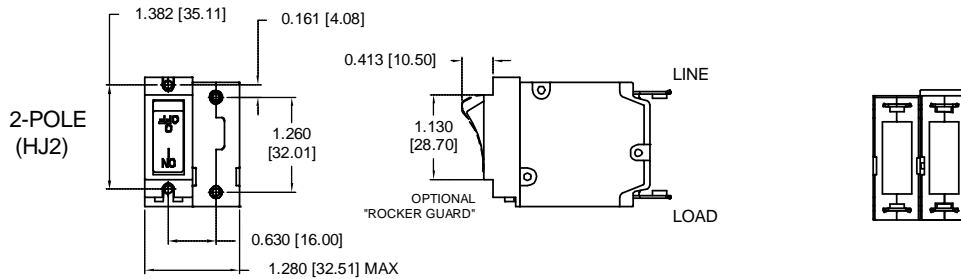
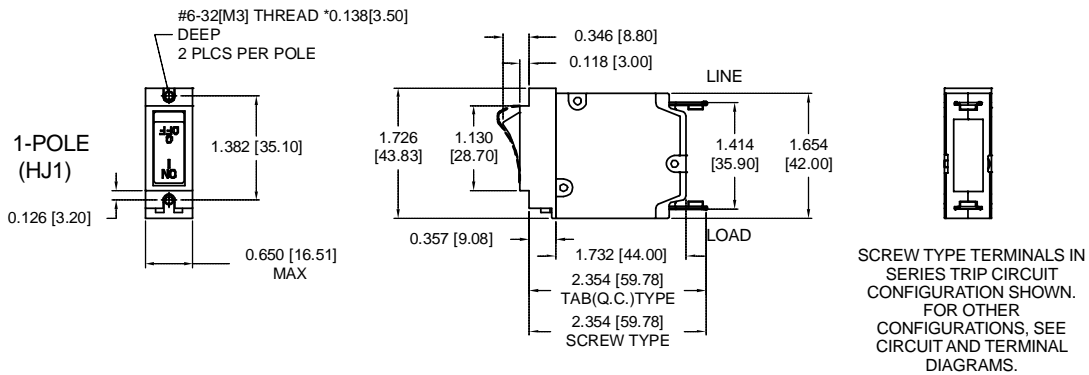

MULTI-POLE IDENTIFICATION SCHEME AS VIEWED FROM TERMINAL END OF BREAKER.

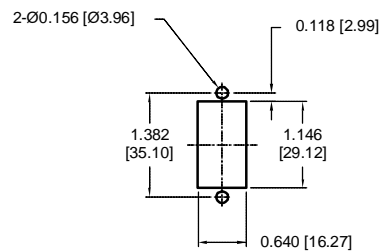

PANEL CUTOUT DETAIL TOLERANCE ±.005[±.12] UNLESS OTHERWISE SPECIFIED

Notes:

- 1 All dimensions are in inches [millimeters].
- 2 Tolerance ±.020 [.51] unless otherwise specified.

Dimensional Specifications: in. [mm]

PUSH-TO-RESET ACTUATOR

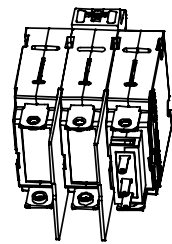
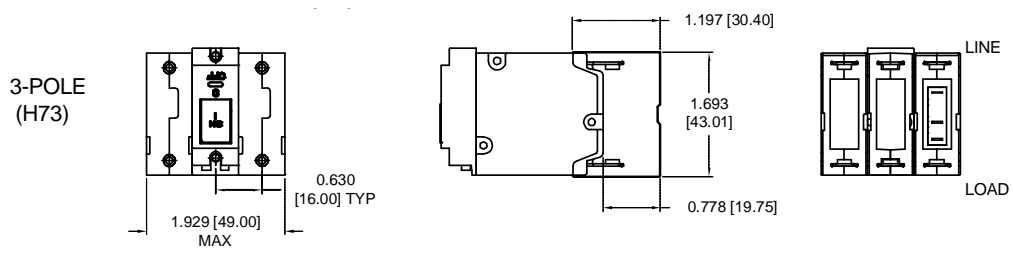
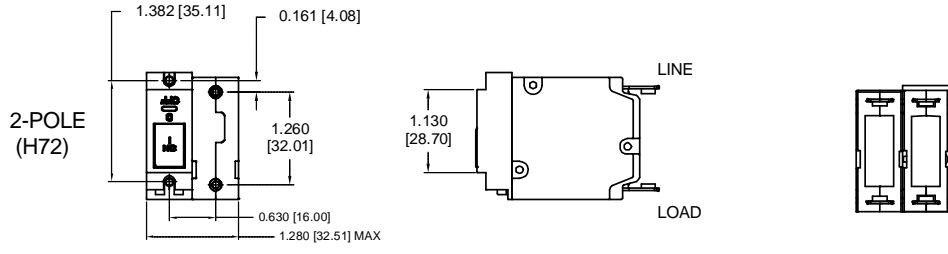
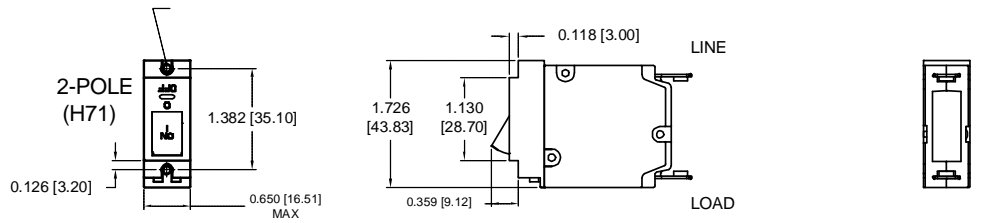
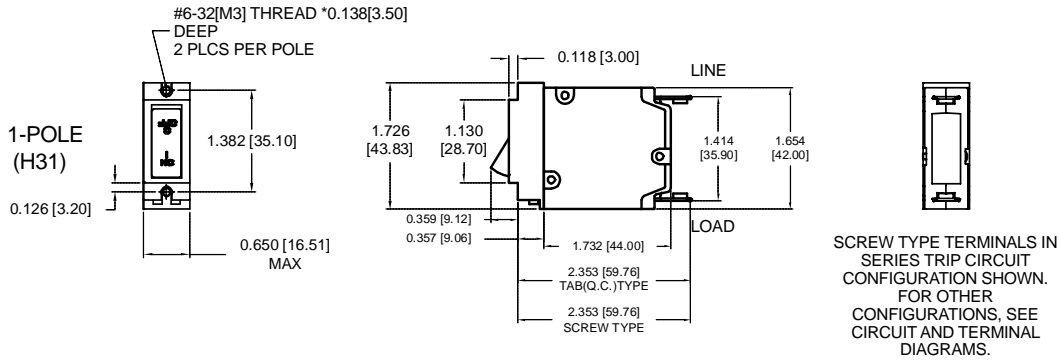

MULTI-POLE IDENTIFICATION SCHEME AS VIEWED FROM TERMINAL END OF BREAKER.

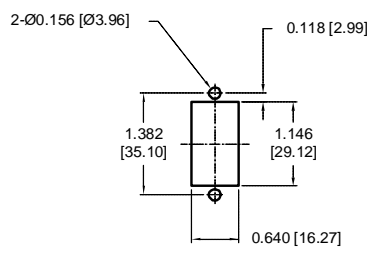

PANEL CUTOUT DETAIL TOLERANCE ±.005[±.12] UNLESS OTHERWISE SPECIFIED

Notes:
1 All dimensions are in inches [millimeters].
2 Tolerance ±.020 [.51] unless otherwise specified.

PC Terminal Diagrams: in. [mm]

PRINTED CIRCUIT BOARD MOUNTING
TERMINAL CODE R

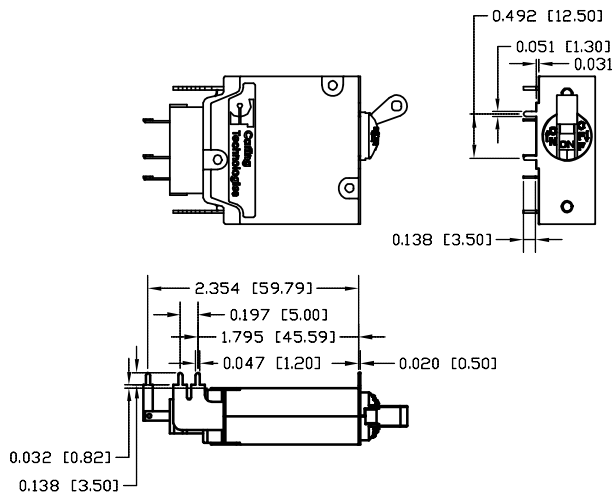

PRINTED CIRCUIT BOARD MOUNTING
TERMINAL CODE L

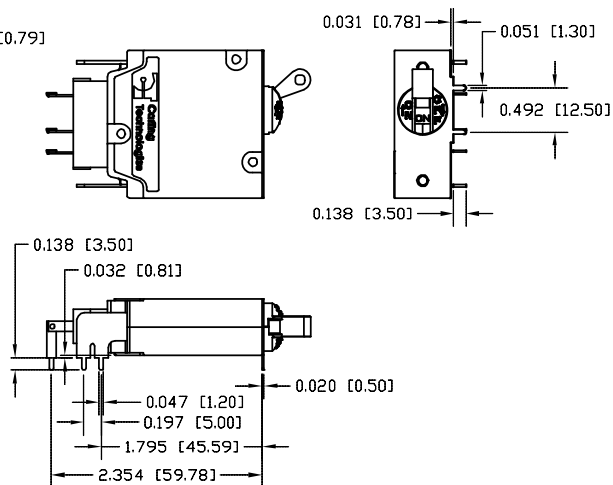

PRINTED CIRCUIT BOARD MOUNTING
TERMINAL CODE S & T

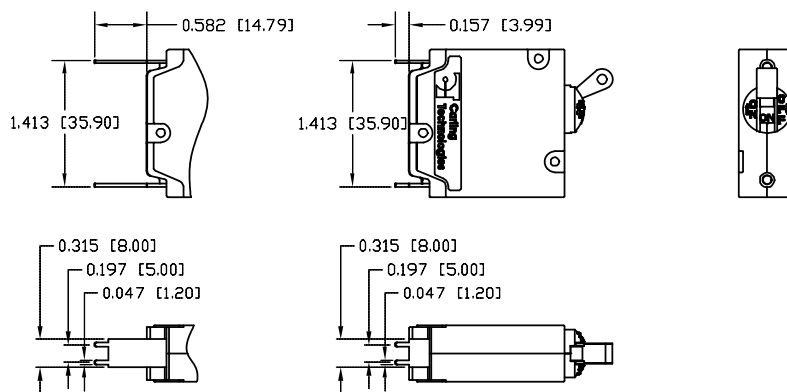

Notes:

- 1 All dimensions are in inches [millimeters].
- 2 Tolerance ± 0.20 [5.1] unless otherwise specified.

PC Terminal Diagrams: in. [mm]

P.C. FOOT PRINT
FOR TERMINAL CODE R

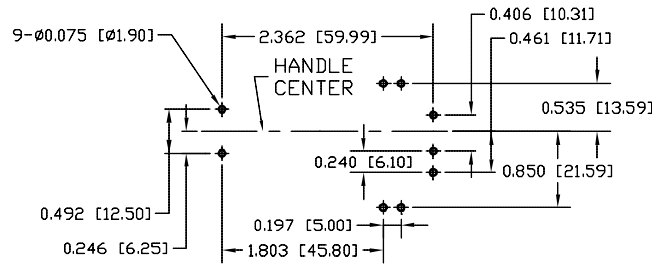

P.C. FOOT PRINT
FOR TERMINAL CODE L

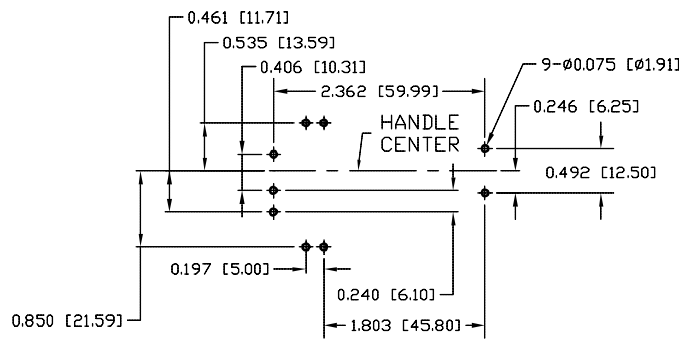

P.C. FOOT PRINT
FOR TERMINAL CODE S & T

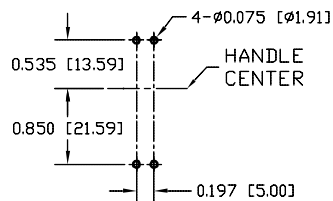

Notes:

- 1 All dimensions are in inches [millimeters].
- 2 Tolerance ± 0.020 [51] unless otherwise specified.

Circuit & Terminal Diagrams: in. [mm]

HANDLE POSITION VS. AUX SWITCH MODE		
STANDARD C/B		
CIRCUIT BREAKER MODE	HANDLE POSITION	AUX. SWITCH MODE
OFF		
ON		
ELECTRICAL TRIP		

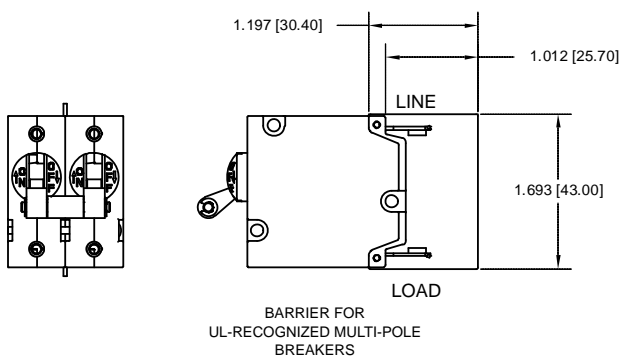
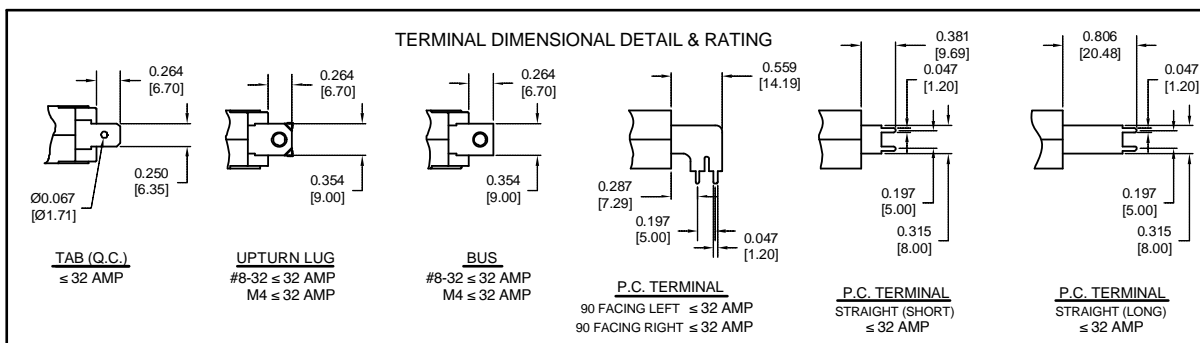
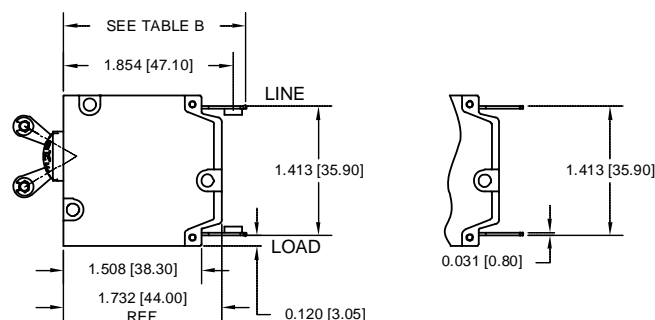

**TABLE A
TIGHTENING TORQUE
SPECIFICATIONS**

THREAD SIZE	TORQUE
#6-32 & M3 MOUNTING HARDWARE	7-9 IN-LBS [0.8-1.0 NM]
#8-32 & M4 THREAD TERMINAL SCREW	12-15 IN-LBS [1.4-1.7 NM]

TABLE B

TERMINAL DESCRIPTION		DEPTH BEHIND PANEL
MAIN	TAB (Q.C.)	1.996 [50.70]
	SCREW TYPE	1.996 [50.70]
AUX. SWITCH*	.110 TAB (Q.C.)	2.467 [62.67]
	SOLDER TYPE	2.252 [57.19]



* AVAILABLE ON SERIES TRIP AND SWITCH ONLY CIRCUITS.
WHEN CALLED FOR ON MULTI-POLE UNITS, ONLY ONE AUX. SWITCH IS NORMALLY SUPPLIED, AS SHOWN IN MULTI-POLE IDENTIFICATION SCHEME.

1. ALL DIMENSIONS ARE IN INCHES [mm]
2. TOLERANCE ±.020 [.51] UNLESS OTHERWISE SPECIFIED.

Circuit & Terminal Diagrams: in. [mm]

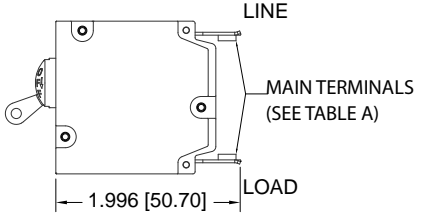
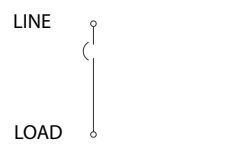
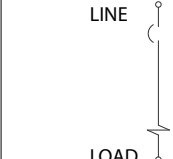
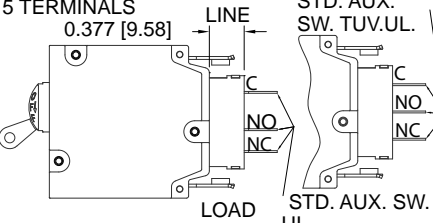
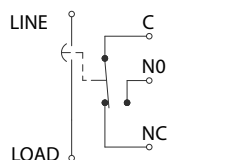
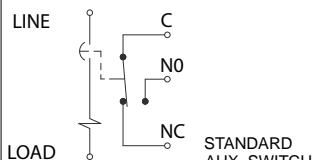
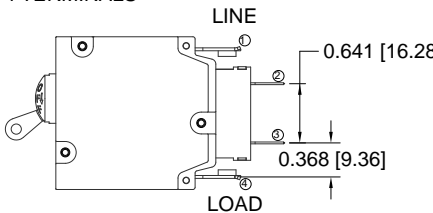
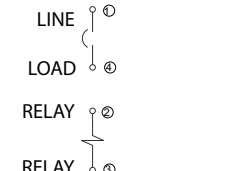
CIRCUIT BREAKER PROFILE	CIRCUIT SCHEMATIC		CIRCUIT CODE	AUX SWITCH CODE	CIRCUIT SCHEMATIC		
	ANSI	ANSI			ANSI	CIRCUIT CODE	AUX SWITCH CODE
2 TERMINALS 	SWITCH ONLY (NO COIL) 		A	0	SERIES TRIP 	B	0
5 TERMINALS 0.377 [9.58] 	SWITCH ONLY (NO COIL) WITH AUXILIARY SWITCH 		A	1 2 3	SERIES TRIP WITH AUXILIARY 	B	1 2 3
4 TERMINALS 	RELAY TRIP 		F G	0			

AUXILIARY SWITCH TERMINAL DETAIL

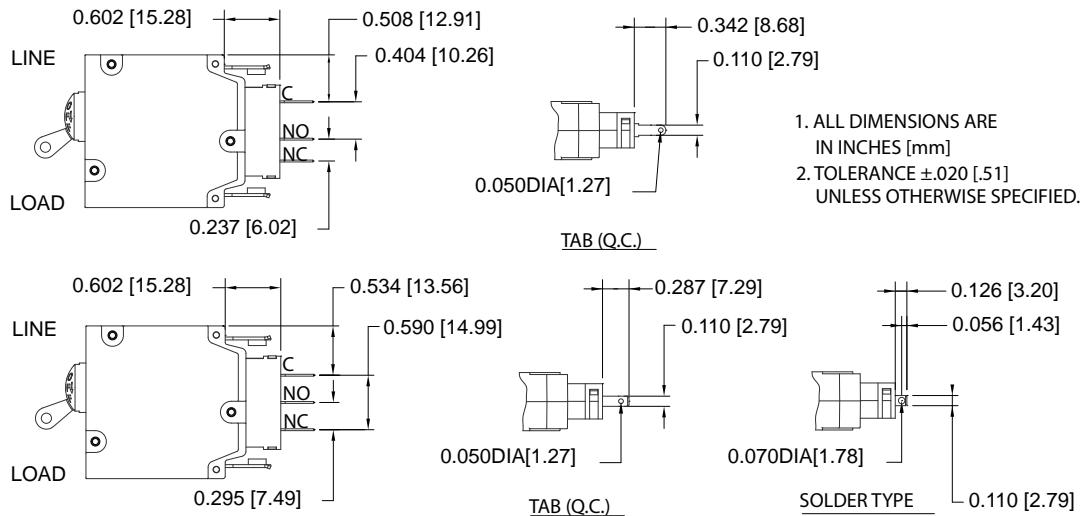

Authorized Sales Representatives

Click on the group name on the map below to find your local representative or visit www.carlingtech.com/findarep.

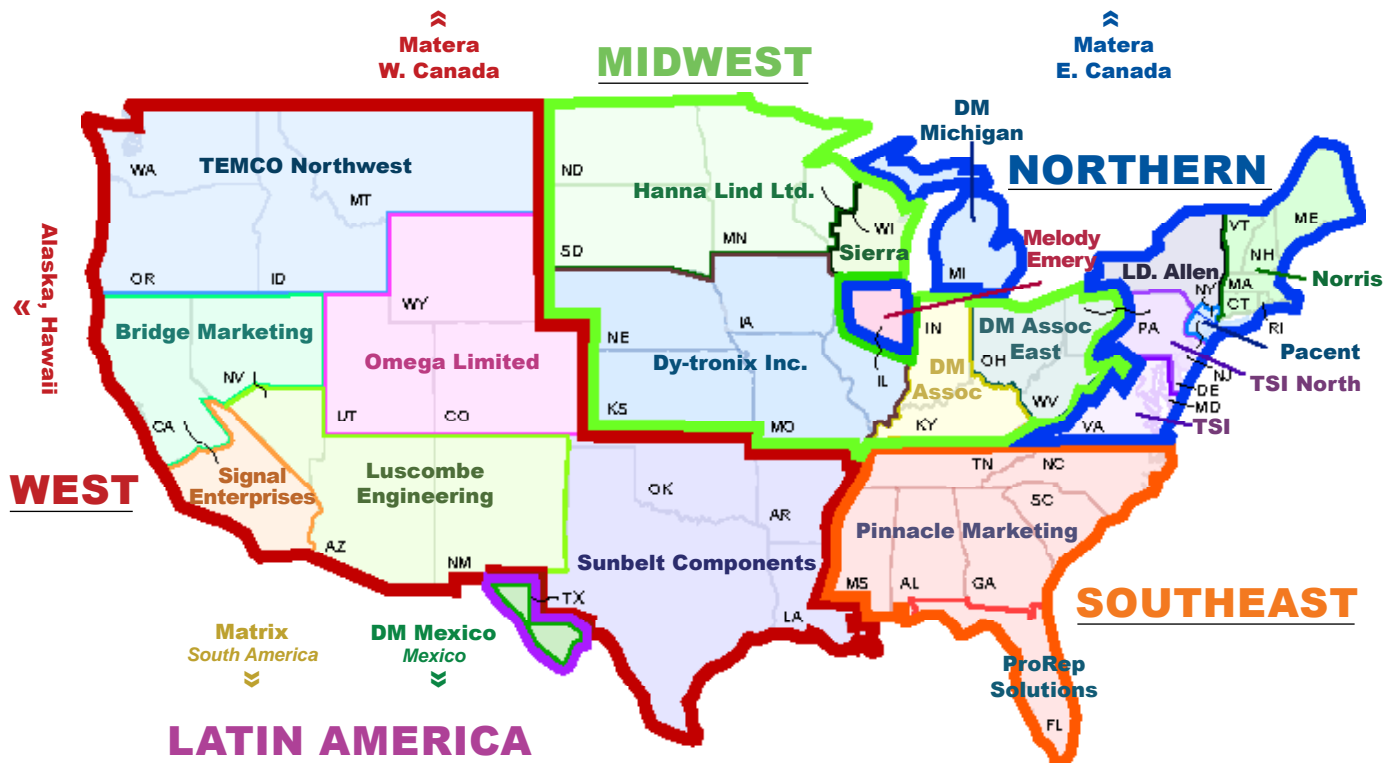

Americas



Europe
Middle East
Africa



Asia-Pacific
Oceania

About Carling

Founded in 1920, Carling Technologies is a leading manufacturer of electrical and electronic switches and assemblies, circuit breakers, electronic controls, power distribution units, and multiplexed power distribution systems. With four ISO registered manufacturing facilities and technical sales offices worldwide, Carling Technologies Sales, Service and Engineering teams do much more than manufacture electrical components, they engineer powerful solutions! To learn more about Carling please visit www.carlingtech.com/company-profile.

To view all of Carling's environmental, quality, health & safety certifications please visit www.carlingtech.com/environmental-certifications

Worldwide Headquarters

Carling Technologies, Inc.
60 Johnson Avenue, Plainville, CT 06062
Phone: 860.793.9281 **Fax:** 860.793.9231
Email: sales@carlingtech.com

Northern Region Sales Office: nrsm@carlingtech.com
Southeast Region Sales Office: sersm@carlingtech.com
Midwest Region Sales Office: mrsrm@carlingtech.com
West Region Sales Office: wrsm@carlingtech.com
Latin America Sales Office: larsm@carlingtech.com

Asia-Pacific Headquarters

Carling Technologies, Asia-Pacific Ltd.,
Kowloon, Hong Kong
Phone: Int + 852-2737-2277 **Fax:** Int + 852-2736-9332
Email: sales@carlingtech.com.hk

Shenzhen, China: shenzhen@carlingtech.com
Shanghai, China: shanghai@carlingtech.com
Pune, India: india@carlingtech.com
Kaohsiung, Taiwan: taiwan@carlingtech.com
Yokohama, Japan: japan@carlingtech.com

Europe | Middle East | Africa Headquarters

Carling Technologies LTD
4 Airport Business Park, Exeter Airport,
Clyst Honiton, Exeter, Devon, EX5 2UL, UK
Phone: Int + 44 1392.364422 **Fax:** Int + 44 1392.364477
Email: ltd.sales@carlingtech.com

Germany: gmbh@carlingtech.com
France: sas@carlingtech.com



Carling Technologies®

Innovative Designs. Powerful Solutions.