

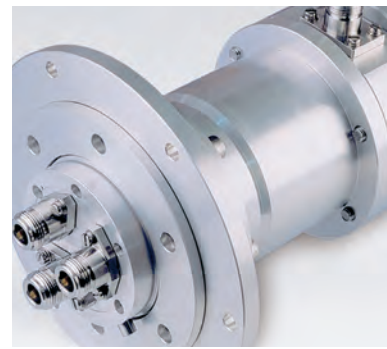

SPINNER || AIR TRAFFIC CONTROL ROTARY JOINTS

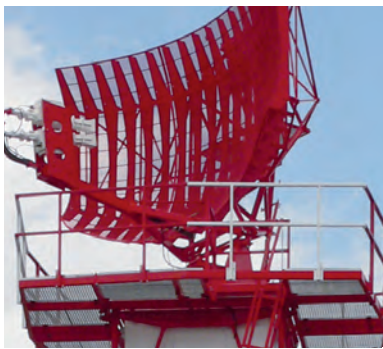

Edition B | 2015

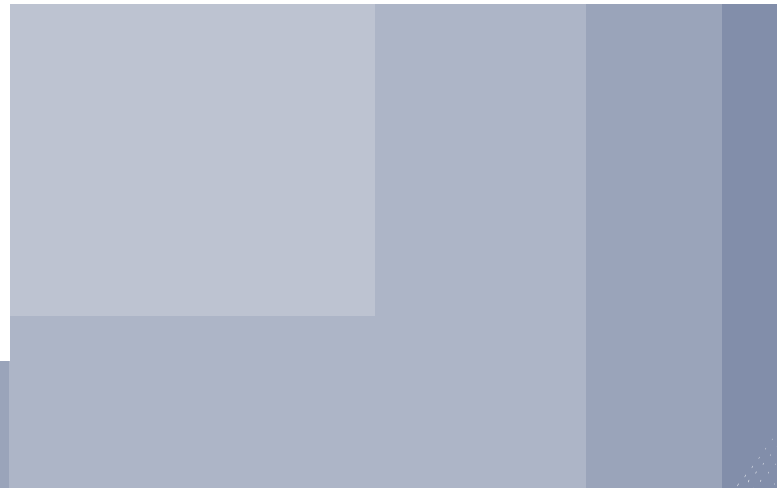
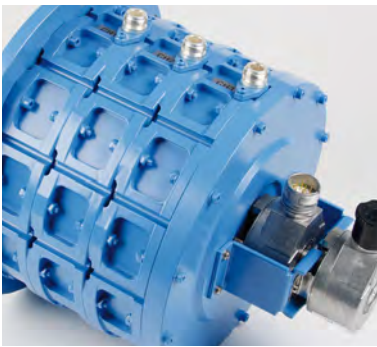

High Frequency Performance Worldwide
www.spinner-group.com



[On our website you will find our latest updates.](#)

As your contribution to environmental protection you can also download our catalogues as PDF files. This catalogue has been printed on wood-free Primaset paper.

The specifications given here as well as the illustrations are for advance information. They shall only be confirmed by SPINNER's written offer and are subject to technical amendments.

© 2015 SPINNER GmbH

CONTENT

Rotary Joints

3 Channel Coax Rotary Joints	6
3 Channel Waveguide Coax Rotary Joints	10
4 Channel Coax Rotary Joints	12
4 Channel Waveguide Coax Rotary Joints	14
6 Channel Waveguide Coax Rotary Joints	15
7 Channel Coax Rotary Joints	21
7 Channel Waveguide Coax Rotary Joints	22
9 Channel Coax Rotary Joints	25
Rotary Joints & Slip Rings Specification	26
Technical Annex	30

3 Channel
4 Channel
6 Channel
7 Channel
9 Channel



Safety is the highest demand in a high-density airspace. This affects air traffic management in the civil and military domain. This relies mostly on highly sophisticated radar systems for airport surface movements, air surveillance, en-route tracking and weather observation.

As an international leader in innovation, SPINNER is a reliable supplier of advanced components for radar systems. Since the early sixties SPINNER sets standards worldwide. Our innovations in this field together with our technical know-how and our top quality claim have allowed us to become one of the leading rotary joint manufacturers.

Rotary joints are needed in radar systems, wherever signals have to be transmitted between a fixed platform and a continuously rotating antenna system. These include the broad field of Air Traffic Control (ATC) radar systems like Surface Movement Radar (SMR), Precision Approach Radar (PAR), Air Surveillance Radar (ASR), en-route radar or Doppler Weather Radars (DWR).

Special benefits of SPINNER rotary joints are their compact design, excellent VSWR and low insertion loss, low variation of transmission properties during rotation, and high crosstalk attenuation between the individual channels over the whole frequency range.

The wealth of experience that our engineers have with rotary joints in military use and our commitment to continuous product improvement are the basis of our great success. When it comes to application in ATC, all major customers in Europe already trust in our rotary joints.

As an additional service SPINNER offers repair and maintenance of all ATC rotary joint brands.





CUSTOM-MADE ROTARY JOINTS

For an enquiry to a custom-made rotary joint, our specification sheet assists you defining your system. Please find it on page 26.

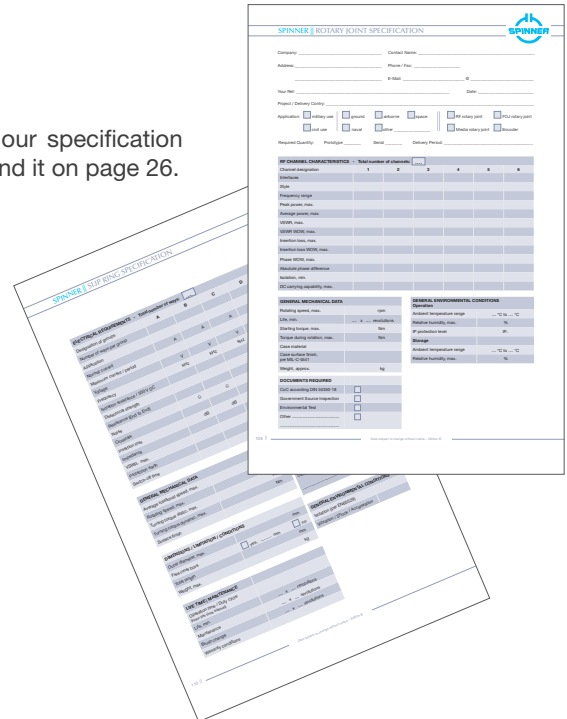

SPINNER ROTARY JOINT SPECIFICATION

Company: _____ Contact Name: _____
 Address: _____ Phone: _____
 Fax: _____ E-Mail: _____
 Year built: _____
 Project / Delivery Country: _____
 Application: Military use Police Airbase Marine For rotary joint For stationary joint
 Land use Land Other _____ Under rotary joint Receiver
 Proposed Country: _____ Package: _____ Serial: _____ Delivery Period: _____

GENERAL CHARACTERISTICS - Total number of channels: []

Channel designation	A	B	C	D	E	F
Structure						
Material						
Weight						
Rotational range						
Rotation speed						
Control system						
Wiring						
Mounting base						
Number of axes						
Installation height						
Power supply						
Rotation speed						
Rotation speed tolerance						
Rotation speed						
DC supply capability						

GENERAL MECHANICAL DATA

Rotary joint type: _____
 IPR type: _____
 Rotational speed: _____
 Rotational speed tolerance: _____
 Control system: _____
 Control system: _____
 IPR type: _____
 IPR type: _____
 IPR type: _____

GENERAL ENVIRONMENTAL CONDITIONS

Operating temperature range: _____ °C to _____ °C
 Storage temperature range: _____ °C to _____ °C
 Humidity: _____
 Relative humidity range: _____ %
 Relative humidity range: _____ %

ACCESSORIES

DC supply capability: Yes No
 Rotational speed tolerance: Yes No
 Rotational speed: Yes No
 Other: _____

3 CHANNEL COAX ROTARY JOINT | L-BAND

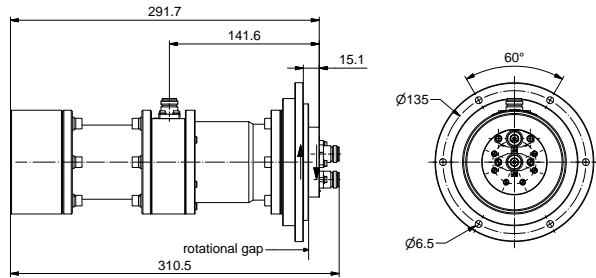

RF channel characteristics			
Channel designation	Channel 1	Channel 2	Channel 3
Interfaces	N-f (50 Ω)		
Frequency range	0.9 - 1.2 GHz		
Peak power, max.	10 kW		
Average power, max.	300 W	50 W	50 W
VSWR, max.	1.2 @ 1 - 1.1 GHz 1.3 @ 0.9 - 1.2 GHz		
VSWR WOW, max.	0.05		
Insertion loss, max.	0.4 dB @ 1 - 1.1GHz 0.6 dB @ 0.9 - 1.2 GHz		
Insertion loss WOW, max.	0.05 dB		
Isolation, min.	60 dB		
Phase WOW, max.	2 deg.		

General mechanical data	
Rotating speed, max.	200 rpm
Life, min.	200 x 10 ⁶ revolutions
Starting torque, max.	5 Nm @ room temperature
Torque during rotation, max.	5 Nm @ room temperature
Case material	aluminium alloy
Case surface finish,	chromate conversion coat per MIL-DTL-5541 type 1 or type 2
Weight, approx.	8 kg

General environmental conditions	
Operation	
Ambient temperature range	-55 °C ... +85 °C
Relative humidity, max.	95% (non-condensing)
IP protection level	IP60
Storage	
Ambient temperature range	-55 °C ... +85 °C
Relative humidity, max.	95% (non-condensing)

3 CHANNEL COAX ROTARY JOINT | L-BAND

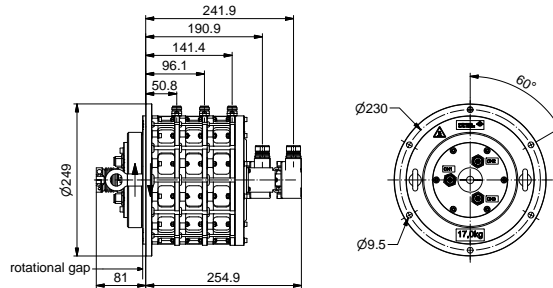

3 Channel

RF channel characteristics			
Channel designation	Channel 1	Channel 2	Channel 3
Interfaces	N-f (50 Ω)		
Frequency range	1.0 - 1.11 GHz		
Peak power, max.	20 kW		
Average power, max.	500 W		
VSWR, max. / typ.	1.3 / 1.2		
VSWR WOW, max.	0.05		
Insertion loss, max. / typ.	0.5 dB / 0.4 dB		
Insertion loss WOW, max.	0.03 dB		
Isolation, min.	60 dB		
Phase WOW, max.	1.5 deg.		

Encoder characteristics	
Type / manufacturer	2 x DFS60A-TGAA65536 (Fa. SICK-Stegmann AG)

General mechanical data	
Rotating speed, max.	60 rpm
Life, min.	200 x 10 ⁶ revolutions
Starting torque, max.	2 Nm @ room temperature
Torque during rotation, max.	2 Nm @ room temperature
Case material	aluminium alloy
Case surface finish	chromate conversion coat per MIL-DTL-5541 type 1 or type 2 / painted
Weight, approx.	17 kg

General environmental conditions	
Operation	
Ambient temperature range	-55 °C ... +71 °C (encoder excluded)
Relative humidity, max.	95% (non-condensing)
IP protection level	IP50
Storage	
Ambient temperature range	-40 °C ... +85 °C (encoder excluded)
Relative humidity, max.	95% (non-condensing)

3 CHANNEL COAX ROTARY JOINT | L-BAND

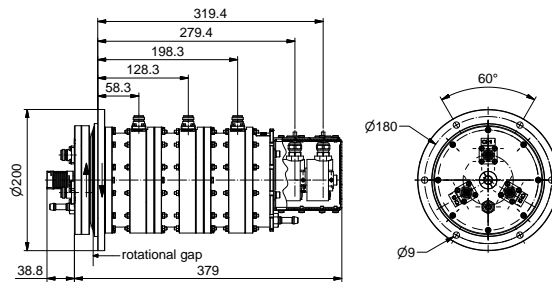

RF channel characteristics			
Channel designation	Channel 1	Channel 2	Channel 3
Interfaces	N-f (50 Ω)		
Frequency range	0.95 - 1.15 GHz		
Peak power, max.	10 kW		
Average power, max.	200 W	100 W	100 W
VSWR, max.	1.25		
VSWR WOW, max.	0.05		
Insertion loss, max. / typ.	0.5 dB / 0.4 dB		
Insertion loss WOW, max.	0.03 dB		
Isolation, min.	60 dB		
Phase WOW, max.	1.5 deg.		

Encoder characteristics	
Type / manufacturer	2 x DHO5_14//RP29//3600 / BEI-IDEACOD, France

General mechanical data	
Rotating speed, max.	200 rpm
Life, min.	200 x 10 ⁶ revolutions
Starting torque, max.	2 Nm @ room temperature
Torque during rotation, max.	2 Nm @ room temperature
Case material	aluminium alloy
Case surface finish	chromate conversion coat per MIL-DTL-5541 type 1 or type 2 / painted
Weight, approx.	14 kg

General environmental conditions	
Operation	
Ambient temperature range	-55 °C ... +71 °C (encoder excluded)
Relative humidity, max.	95% (non-condensing)
IP protection level	IP54
Storage	
Ambient temperature range	-55 °C ... +85 °C (encoder excluded)
Relative humidity, max.	95% (non-condensing)

3 CHANNEL COAX ROTARY JOINT | L-BAND

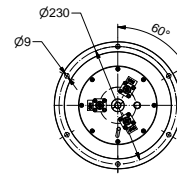
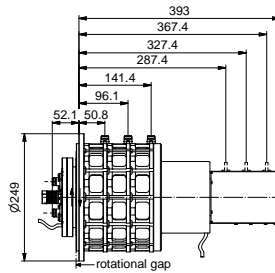

3 Channel

RF channel characteristics			
Channel designation	Channel 1	Channel 2	Channel 3
Interfaces	N-f (50 Ω)		
Frequency range	1.0 - 1.11 GHz		
Peak power, max.	20 kW		
Average power, max.	200 W		
VSWR, max.	1.3		
VSWR WOW, max.	0.05		
Insertion loss, max.	0.5 dB		
Insertion loss WOW, max.	0.05 dB		
Isolation, min.	60 dB		
Phase WOW, max.	1.5 deg.		

Encoder characteristics	
Type / manufacturer	3x DFS60 (Fa. SICK-Stegmann AG)

Slip rings characteristics	
Total number of ways	6

General mechanical data	
Rotating speed, max.	60 rpm
Life, min.	200 x 10 ⁶ revolutions
Starting torque, max.	2 Nm @ room temperature
Torque during rotation, max.	2 Nm @ room temperature
Case material	aluminium alloy
Case surface finish	chromate conversion coat per MIL-DTL-5541 type 1 or type 2 / painted
Weight, approx.	22 kg

General environmental conditions	
Operation	
Ambient temperature range	-55 °C ... +71 °C (encoder excluded)
Relative humidity, max.	95% (non-condensing)
IP protection level	IP50
Storage	
Ambient temperature range	-55 °C ... +85 °C (encoder excluded)
Relative humidity, max.	95% (non-condensing)

3 CHANNEL WAVEGUIDE COAX ROTARY JOINT | S-BAND

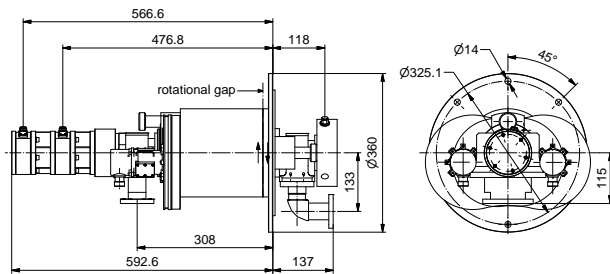

RF channel characteristics			
Channel designation	Channel 1	Channel 2	Channel 3
Interfaces	WR284	N-f (50 Ω)	N-f (50 Ω)
Frequency range	2.7 - 2.9 GHz		
Peak power, max.	35 kW	10 kW	
Average power, max.	3000 W	75 W	
VSWR, max.	1.2	1.25	
VSWR WOW, max.	0.05		
Insertion loss, max.	0.15 dB	0.9 dB	
Insertion loss WOW, max.	0.05 dB	0.05 dB	
Isolation, min.	60 dB		
Phase WOW, max.	2 deg.		

Encoder characteristics	
Type / manufacturer	Absolute optical encoder OCD-S101G-0013-C100-PRL / POSITAL FRABA N. V., Netherlands

Slip rings characteristics	
Total number of ways	20

General mechanical data	
Differential operating pressure, max./nom.	0.07 MPa (10 psi) / 0.035 MPa (5 psi)
Leakage rate, max.	20 cm ³ / minute
Rotating speed, max.	60 rpm
Life, min.	40 x 10 ⁶ revolutions
Maintenance period, min.	20 x 10 ⁶ revolutions
Starting torque, max.	4.5 Nm @ room temperature
Torque during rotation, max.	4.5 Nm @ room temperature
Case material	aluminium alloy
Case surface finish	chromate conversion coat per MIL-DTL-5541 type 1 or type 2 / painted
Weight, approx.	37 kg

General environmental conditions	
Operation	
Ambient temperature range	-40 °C ... +71 °C (encoder excluded)
Relative humidity, max.	95% (non-condensing)
IP protection level	IP65
Storage	
Ambient temperature range	-55 °C ... +85 °C (encoder excluded)
Relative humidity, max.	95% (non-condensing)

3 CHANNEL WAVEGUIDE COAX ROTARY JOINT | S-BAND

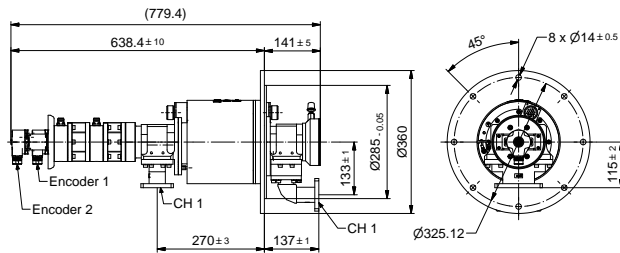

3 Channel

RF channel characteristics			
Channel designation	Channel 1	Channel 2	Channel 3
Interfaces	special flange WR284	N-f (50 Ω)	N-f (50 Ω)
Frequency range	2.7 - 2.9 GHz		
Peak power, max.	200 kW	10 kW	10 kW
Average power, max.	3500 W	75 W	75 W
VSWR, max.	1.2	1.25	1.25
VSWR WOW, max.	0.05	0.05	0.05
Insertion loss, max.	0.15 dB	0.9 dB	0.9 dB
Insertion loss WOW, max.	0.03 dB	0.03 dB	0.03 dB
Isolation, min.	70 dB	60 dB	
Phase WOW, max.	1.5 deg.	2 deg.	

Encoder characteristics	
Type / manufacturer	2 x DFS60A-TGAA65536 / Firma SICK

Slip rings characteristics	
Total number of ways	15

General mechanical data	
Differential operating pressure, max./nom.	0.07 MPa (10 psi) / 0.035 MPa (5 psi)
Leakage rate, max.	25 cm ³ / minute
Rotating speed, max.	60 rpm
Life, min.	40 x 10 ⁶ revolutions
Maintenance period, min.	20 x 10 ⁶ revolutions
Starting torque, max.	4.5 Nm @ room temperature
Torque during rotation, max.	4.5 Nm @ room temperature
Case material	aluminium alloy
Case surface finish	chromate conversion coat per MIL-DTL-5541 type 1 or type 2 / painted
Weight, approx.	35 kg

General environmental conditions	
Operation	
Ambient temperature range	-40 °C ... +71 °C (encoder excluded)
Relative humidity, max.	95% (non-condensing)
IP protection level	IP65
Storage	
Ambient temperature range	-55 °C ... +85 °C (encoder excluded)
Relative humidity, max.	95% (non-condensing)

4 CHANNEL COAX ROTARY JOINT | L-BAND

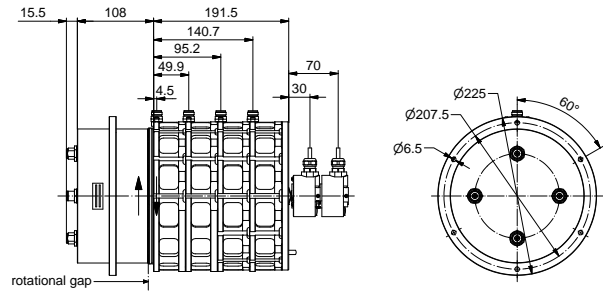

RF channel characteristics				
Channel designation	Channel 1	Channel 2	Channel 3	Channel 4
Interfaces	N-f (50 Ω)			
Frequency range	1.03 - 1.09 GHz		1.2 - 1.4 GHz	
Peak power, max.	20 kW		20 kW	
Average power, max.	500 W		100 W	
VSWR, max.	1.25		1.3	
VSWR WOW, max.	0.05			
Insertion loss, max.	0.8 dB		1.2 dB	
Insertion loss WOW, max.	0.05 dB			
Isolation, min.	60 dB			
Phase WOW, max.	1.5 deg.			

Encoder characteristics	
Type / manufacturer	2 x DHO5_14//RP29//3600 / BEI-IDEACOD, France

General mechanical data	
Rotating speed, max.	60 rpm
Life, min.	200 x 10 ⁶ revolutions
Starting torque, max.	3 Nm @ room temperature
Torque during rotation, max.	3 Nm @ room temperature
Case material	aluminium alloy
Case surface finish	chromate conversion coat per MIL-DTL-5541 type 1 or type 2 / painted
Weight, approx.	20 kg

General environmental conditions	
Operation	
Ambient temperature range	-55 °C ... +71 °C (encoder excluded)
Relative humidity, max.	95% (non-condensing)
IP protection level	IP54
Storage	
Ambient temperature range	-55 °C ... +85 °C (encoder excluded)
Relative humidity, max.	95% (non-condensing)

4 CHANNEL COAX ROTARY JOINT | L-BAND

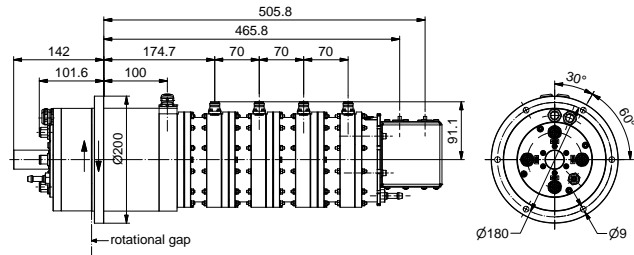

RF channel characteristics				
Channel designation	Channel 1	Channel 2	Channel 3	Channel 4
Interfaces	N-f (50 Ω)			
Frequency range	1.215 - 1.4 GHz			
Peak power, max.	10 W			
Average power, max.	50 W			
VSWR, max.	1.25			
VSWR WOW, max.	0.05			
Insertion loss, max.	0.5 dB			
Insertion loss WOW, max.	0.05 dB			
Isolation, min.	60 dB			
Phase WOW, max.	2 deg.			

Encoder characteristics	
Type / manufacturer	2 x DHO5_14//RP29//3600 / BEI-IDEACOD, France

Slip rings characteristics	
Total number of ways	14

General mechanical data	
Rotating speed, max.	60 rpm
Life, min.	40 x 10 ⁶ revolutions
Maintenance period, min.	20 x 10 ⁶ revolutions
Starting torque, max.	4.5 Nm @ room temperature
Torque during rotation, max.	4.5 Nm @ room temperature
Case material	aluminium alloy
Case surface finish	chromate conversion coat / painted
Weight, approx.	25 kg

General environmental conditions	
Operation	
Ambient temperature range	-40 °C ... +71 °C (encoder excluded)
Relative humidity, max.	95% (non-condensing)
IP protection level	IP54
Storage	
Ambient temperature range	-55 °C ... +85 °C (encoder excluded)
Relative humidity, max.	95% (non-condensing)

4 Channel

4 CHANNEL WAVEGUIDE COAX ROTARY JOINT | S-BAND

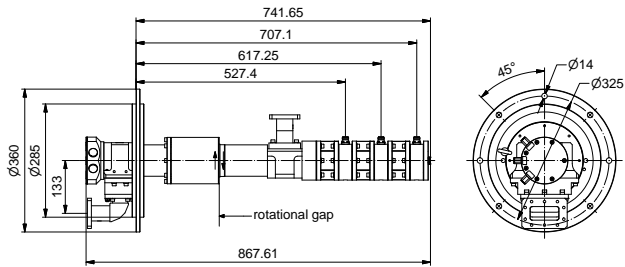
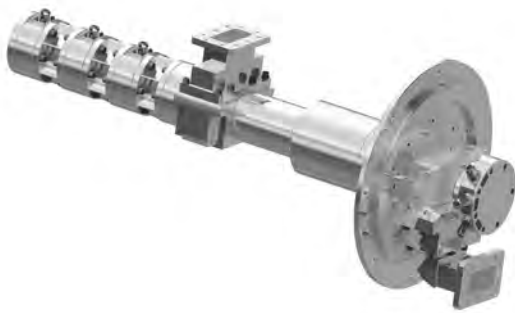

RF channel characteristics				
Channel designation	Channel 1	Channel 2	Channel 3	Channel 4
Interfaces	special flange WR284		N-f (50 Ω)	
Frequency range	2.7 - 3.1 GHz			
Peak power, max.	200 kW		5 kW	
Average power, max.	3500 W		75 W	
VSWR, max. / typ.	1.25 / 1.15		1.25 / 1.15	
VSWR WOW, max.	0.05		0.05	
Insertion loss, max. / typ.	0.3 dB / 0.2 dB		1 dB / 0.8 dB	
Insertion loss WOW, max.	0.03 dB		0.03 dB	
Isolation, min.		60 dB		
Phase WOW, max.	1.5 deg.		2 deg.	

General mechanical data	
Differential operating pressure, max. / nom.	0.01 MPa (1.4 psi) / 0.0014 MPa (0.2 psi)
Leakage rate, max.	25 cm ³ / minute
Rotating speed, max.	60 rpm
Life, min.	200 x 10 ⁶ revolutions
Maintenance period, min.	20 x 10 ⁶ revolutions
Starting torque, max.	10 Nm @ room temperature
Torque during rotation, max.	10 Nm @ room temperature
Case material	aluminium alloy
Case surface finish	chromate conversion coat per MIL-DTL-5541 type 1 or type 2 / painted
Weight, approx.	35 kg

General environmental conditions	
Operation	
Ambient temperature range	-40 °C ... +71 °C
Relative humidity, max.	95% (non-condensing)
IP protection level	IP65
Storage	
Ambient temperature range	-55 °C ... +85 °C
Relative humidity, max.	95% (non-condensing)

6 CHANNEL WAVEGUIDE COAX ROTARY JOINT | L-BAND / L-BAND

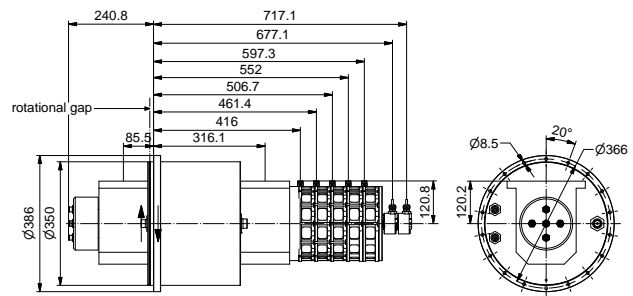

RF channel characteristics						
Channel designation	Channel 1	Channel 2	Channel 3	Channel 4	Channel 5	Channel 6
Interfaces	WR 650	N-f (50 Ω)				
Frequency range	1.2 - 1.4 GHz			1.0 - 1.1 GHz		
Peak power, max.	400 kW	20 kW				
Average power, max.	11 kW	440 W				
VSWR, max.	1.25	1.3				
VSWR WOW, max.	0.05					
Insertion loss, max.	0.2 dB	0.75 dB		0.95 dB		
Insertion loss WOW, max.	0.05 dB					
Isolation, min.	60 dB					
Phase WOW, max.	1.5 deg.					

Encoder characteristics	
Type / manufacturer	2 each DHO5_14//RP29//3600 / BEI-IDEACOD, France

Slip rings characteristics	
Total number of ways	38

General mechanical data	
Differential operating pressure, max. / nom.	0.015 MPa (2 psi) / 0.007 MPa (1 psi)
Leakage rate, max.	25 cm ³ / minute
Rotating speed, max.	60 rpm
Life, min.	40 x 10 ⁶ revolutions
Maintenance period, min.	20 x 10 ⁶ revolutions
Starting torque, max.	3 Nm @ room temperature
Torque during rotation, max.	3 Nm @ room temperature
Case material	aluminium alloy
Case surface finish	chromate conversion coat per MIL-DTL-5541 type 1 or type 2 / painted
Weight, approx.	85 kg

General environmental conditions	
Operation	
Ambient temperature range	-40 °C ... +71 °C (encoder excluded)
Relative humidity, max.	95% (non-condensing)
IP protection level	IP65
Storage	
Ambient temperature range	-55 °C ... +85 °C (encoder excluded)
Relative humidity, max.	95% (non-condensing)

6 Channel

6 CHANNEL WAVEGUIDE COAX ROTARY JOINT | S-BAND / L-BAND

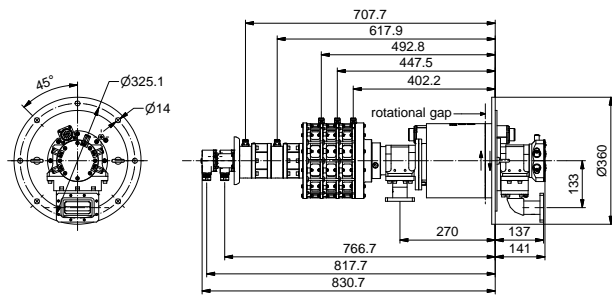

RF channel characteristics						
Channel designation	Channel 1	Channel 2	Channel 3	Channel 4	Channel 5	Channel 6
Interfaces	WR 284	N-f (50 Ω)				
Frequency range	2.7 - 2.9 GHz	2.7 - 3.1 GHz		1 - 1.11 GHz		
Peak power, max.	200 kW	10 kW		20 kW		
Average power, max.	3500 W	75 W		100 W		
VSWR, max.	1.2	1.25		1.3		
VSWR WOW, max.	0.05					
Insertion loss, max.	0.15 dB	0.9 dB		0.75 dB		
Insertion loss WOW, max.	0.05 dB					
Isolation, min.	70 dB	60 dB				
Phase WOW, max.	1.5 deg.	2 deg.		1.5 deg.		

Encoder characteristics	
Type / manufacturer	2x DFS60A-TGAA65536 (Fa. SICK)

Slip rings characteristics	
Total number of ways	20

General mechanical data	
Differential operating pressure, max. / nom.	0.07 MPa (10 psi) / 0.035 MPa (5 psi)
Leakage rate, max.	25 cm ³ / minute
Rotating speed, max.	60 rpm
Life, min.	40 x 10 ⁶ revolutions
Maintenance period, min.	20 x 10 ⁶ revolutions
Starting torque, max.	10 Nm @ room temperature
Torque during rotation, max.	10 Nm @ room temperature
Case material	aluminium alloy
Case surface finish	chromate conversion coat per MIL-DTL-5541 type 1 or type 2 / painted
Weight, approx.	50 kg

General environmental conditions	
Operation	
Ambient temperature range	-40 °C ... +71 °C (encoder excluded)
Relative humidity, max.	95% (non-condensing)
IP protection level	IP54
Storage	
Ambient temperature range	-55 °C ... +85 °C (encoder excluded)
Relative humidity, max.	95% (non-condensing)

6 CHANNEL WAVEGUIDE COAX ROTARY JOINT | S-BAND / L-BAND

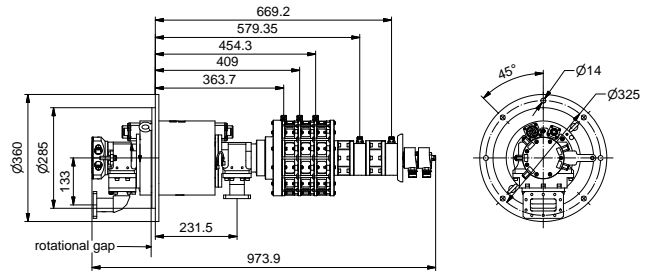

RF channel characteristics						
Channel designation	Channel 1	Channel 2	Channel 3	Channel 4	Channel 5	Channel 6
Interfaces	WR 284	N-f (50 Ω)				
Frequency range	2.7 - 2.9 GHz	2.7 - 3.1 GHz		1 - 1.11 GHz		
Peak power, max.	200 kW	5 kW				
Average power, max.	3500 W	75 W		200 W		
VSWR, max. / typ.	1.2	1.25 / 1.15		1.3 / 1.2		
VSWR WOW, max.	0.05					
Insertion loss, max. / typ	0.15 dB / 0.1 dB	0.9 dB / 0.7 dB		0.75 dB / 0.6 dB		
Insertion loss WOW, max.	0.05 dB					
Isolation, min.	70 dB	60 dB				
Phase WOW, max.	1.5 deg.	2 deg.		1.5 deg.		

Encoder characteristics	
Type / manufacturer	2 each DHO5S14/0B/2G29//16384//G6R BEI-Sensors, France

Slip rings characteristics	
Total number of ways	23

General mechanical data	
Differential operating pressure, max. / nom.	0.02 MPa (2.9psi) / 0.0014 MPa (0.2 psi)
Leakage rate, max.	25 cm ³ / minute
Rotating speed, max.	60 rpm
Life, min.	40 x 10 ⁶ revolutions
Maintenance period, min.	20 x 10 ⁶ revolutions
Starting torque, max.	10 Nm @ room temperature
Torque during rotation, max.	10 Nm @ room temperature
Case material	aluminium alloy
Case surface finish	chromate conversion coat per MIL-DTL-5541 type 1 or type 2 / painted
Weight, approx.	54 kg

General environmental conditions	
Operation	
Ambient temperature range	-40 °C ... +71 °C (encoder excluded)
Relative humidity, max.	95% (non-condensing)
IP protection level	IP54
Storage	
Ambient temperature range	-55 °C ... +85 °C (encoder excluded)
Relative humidity, max.	95% (non-condensing)

6 CHANNEL WAVEGUIDE COAX ROTARY JOINT | S-BAND / L-BAND

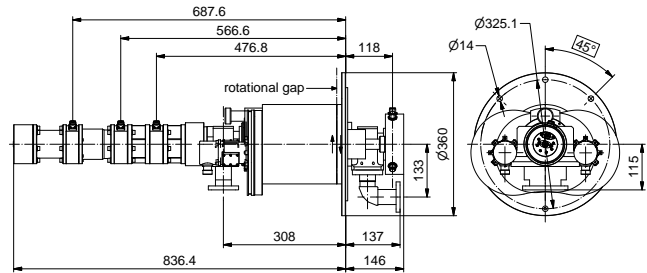

RF channel characteristics						
Channel designation	Channel 1	Channel 2	Channel 3	Channel 4	Channel 5	Channel 6
Interfaces	WR 284	N-f (50 Ω)				
Frequency range	2.7 - 2.9 GHz	2.7 - 3.1GHz		0.95 - 1.15 GHz		
Peak power, max.	200 kW	10 kW				
Average power, max.	3500 W	75 W				
VSWR, max.	1.2	1.25				
VSWR WOW, max.	0.05					
Insertion loss, max.	0.15 dB	0.9 dB	1.0 dB	0.75 dB		
Insertion loss WOW, max.	0.05 dB	0.05 dB				
Isolation, min.	70 dB	60 dB				
Phase WOW, max.	1.5 deg.					

Encoder characteristics	
Type / manufacturer	Absolute optical encoder OCD-S101G-0013-C100-PRL / POSITAL FRABA N. V., Netherlands

Slip rings characteristics	
Total number of ways	20

General mechanical data	
Differential operating pressure, max. / nom.	0.07 MPa (10 psi) / 0.035 MPa (5 psi)
Leakage rate, max.	25 cm ³ / minute
Rotating speed, max.	60 rpm
Life, min.	40 x 10 ⁶ revolutions
Maintenance period, min.	20 x 10 ⁶ revolutions
Starting torque, max.	10 Nm @ room temperature
Torque during rotation, max.	10 Nm @ room temperature
Case material	aluminium alloy
Case surface finish	chromate conversion coat / painted TBD
Weight, approx.	48 kg

General environmental conditions	
Operation	
Ambient temperature range	-40 °C ... +71 °C (encoder excluded)
Relative humidity, max.	95% (non-condensing)
IP protection level	IP65
Storage	
Ambient temperature range	-55 °C ... +85 °C (encoder excluded)
Relative humidity, max.	95% (non-condensing)

6 CHANNEL WAVEGUIDE COAX ROTARY JOINT | S-BAND / L-BAND

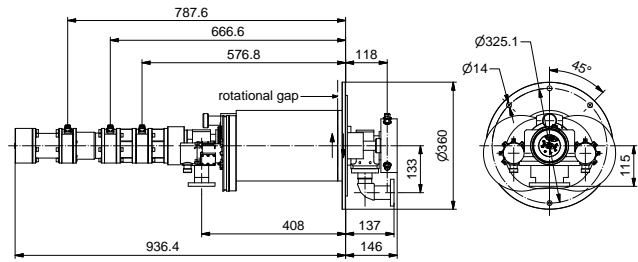

RF channel characteristics						
Channel designation	Channel 1	Channel 2	Channel 3	Channel 4	Channel 5	Channel 6
Interfaces	WR 284	N-f (50 Ω)				
Frequency range	2.7 - 2.9 GHz	2.7 - 3.1 GHz		1.235 - 1.365 GHz		
Peak power, max.	200 kW	10 kW				
Average power, max.	3500 W	75 W				
VSWR, max.	1.2	1.25				
VSWR WOW, max.	0.05					
Insertion loss, max.	0.15 dB	0.9 dB	1.0 dB	0.9 dB		
Insertion loss WOW, max.	0.05 dB	0.05 dB				
Isolation, min.	60 dB					
Phase WOW, max.	1.5 deg.	2 deg.				

Encoder characteristics	
Type / manufacturer	Absolute optical encoder OCD-S101G-0013-C100-PRL / POSITAL FRABA N. V., Netherlands

Slip rings characteristics	
Total number of ways	20

General mechanical data	
Differential operating pressure, max. / nom.	0.07 MPa (10 psi) / 0.035 MPa (5 psi)
Leakage rate, max.	25 cm ³ / minute
Rotating speed, max.	60 rpm
Life, min.	40 x 10 ⁶ revolutions
Maintenance period, min.	20 x 10 ⁶ revolutions
Starting torque, max.	10 Nm @ room temperature
Torque during rotation, max.	10 Nm @ room temperature
Case material	aluminium alloy
Case surface finish	chromate conversion coat per MIL-DTL-5541 type 1 or type 2 / painted
Weight, approx.	48 kg

General environmental conditions	
Operation	
Ambient temperature range	-40 °C ... +71 °C (encoder excluded)
Relative humidity, max.	95% (non-condensing)
IP protection level	IP54
Storage	
Ambient temperature range	-55 °C ... +85 °C (encoder excluded)
Relative humidity, max.	95% (non-condensing)

6 Channel

6 CHANNEL WAVEGUIDE COAX ROTARY JOINT | S-BAND / L-BAND

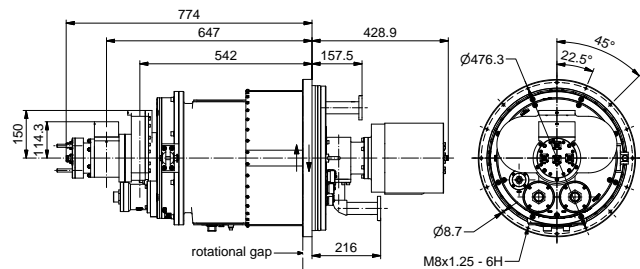

RF channel characteristics						
Channel designation	Channel 1	Channel 2	Channel 3	Channel 4	Channel 5	Channel 6
Interfaces	CPR 284	N-f (50 Ω)				
Frequency range	2.7 - 2.9 GHz			1.0 - 1.12 GHz		
Peak power, max.	30 kW	5 kW	250 W	20 kW		
Average power, max.	3 kW	500 W	25 W	500 W		
VSWR, max.	1.2			1.3		
VSWR WOW, max.	1.05					
Insertion loss, max.	0.15 dB	0.2 dB	0.5 dB	0.75 dB		
Insertion loss WOW, max.	0.15 dB	0.05 dB				
Isolation, min.	60 dB					
Phase WOW, max.	2.5 deg.	2 deg.				

Encoder characteristics	
Type / manufacturer	219409-RX / INDUCTOSYN

Slip rings characteristics	
Total number of ways	30

General mechanical data	
Differential operating pressure, max. / nom.	0.07 MPa (10 psi) / 0.035 MPa (5 psi)
Leakage rate, max.	25 cm ³ / minute
Rotating speed, max.	60 rpm
Life, min.	40 x 10 ⁶ revolutions
Maintenance period, min.	20 x 10 ⁶ revolutions
Starting torque, max.	50 Nm @ room temperature
Torque during rotation, max.	40 Nm @ room temperature
Case material	aluminium alloy
Case surface finish	chromate conversion coat per MIL-DTL-5541 type 1 or type 2 / painted
Weight, approx.	155 kg

General environmental conditions	
Operation	
Ambient temperature range	-40 °C ... +71 °C
Relative humidity, max.	95% (non-condensing)
IP protection level	IP54
Storage	
Ambient temperature range	-55 °C ... +85 °C
Relative humidity, max.	95% (non-condensing)

7 CHANNEL WAVEGUIDE COAX ROTARY JOINT | L-BAND

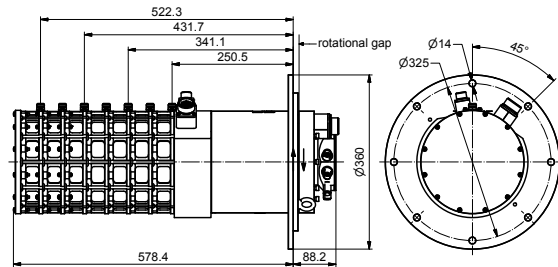

RF channel characteristics							
Channel designation	Channel 1	Channel 2	Channel 3	Channel 4	Channel 5	Channel 6	Channel 7
Interfaces	N-f (50 Ω)						
Frequency range	1 - 1.15 GHz						
Peak power, max.	20 kW				20 kW		
Average power, max.	50 W				100 W		
VSWR, max. / typ.	1.5/ 1.4						
VSWR WOW, max. / typ.	0.1 / 0.05						
Insertion loss, max. / typ.	0.85 dB / 0.75 dB				0.75 dB / 0.65 dB		
Insertion loss WOW, max. / typ.	0.1 dB / 0.05 dB						
Isolation, min. / typ.	60 dB / 80 dB						
Phase WOW, max.	3 deg.						

Slip rings characteristics	
Total number of ways	32

General mechanical data	
Rotating speed, max.	60 rpm
Life, min.	40 x 10 ⁶ revolutions
Maintenance period, min.	20 x 10 ⁶ revolutions
Starting torque, max.	10 Nm @ room temperature
Torque during rotation, max.	9 Nm @ room temperature
Case material	aluminium alloy
Case surface finish	chromate conversion coat per MIL-DTL-5541 type 1 or type 2 / painted
Weight, approx.	30 kg

General environmental conditions	
Operation	
Ambient temperature range	-40 °C ... +71 °C
Relative humidity, max.	95% (non-condensing)
IP protection level	IP65
Storage	
Ambient temperature range	-55 °C ... +85 °C
Relative humidity, max.	95% (non-condensing)

7 Channel

7 CHANNEL WAVEGUIDE COAX ROTARY JOINT | L-BAND

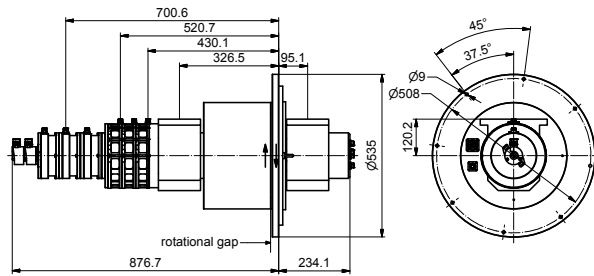

RF channel characteristics							
Channel designation	Channel 1	Channel 2	Channel 3	Channel 4	Channel 5	Channel 6	Channel 7
Interfaces	CPR-650F	N-f (50 Ω)					
Frequency range	1.2 - 1.4 GHz				0.95 - 1.15 GHz		
Peak power, max.	400 kW	20 kW					
Average power, max.	11000 W	440 W			300 W		
VSWR, max.	1.25	1.3					
VSWR WOW, max.	0.05						
Insertion loss, max.	0.2 dB	0.65 dB	0.7 dB	0.75 dB	0.8 dB	0.85 dB	0.9 dB
Insertion loss WOW, max.	0.05 dB						
Isolation, min.	70 dB	60 dB					
Phase WOW, max.	1.5 deg.	2 deg.					

Encoder characteristics	
Type / manufacturer	2 each DHO5S14/0B/2G29//16384//G6R BEI-Sensors, France

Slip rings characteristics	
Total number of ways	21

General mechanical data	
Differential operating pressure, max. / nom.	0.02 MPa (2.9 psi) / 0.0014 MPa (0.2 psi)
Leakage rate, max.	25 cm ³ / minute
Rotating speed, max.	60 rpm
Life, min.	50 x 10 ⁶ revolutions
Maintenance period, min.	12.5 x 10 ⁶ revolutions
Starting torque, max.	18 Nm @ room temperature
Torque during rotation, max.	18 Nm @ room temperature
Case material	aluminium alloy
Case surface finish	chromate conversion coat per MIL-DTL-5541 type 1 or type 2 / painted
Weight, approx.	105 kg

General environmental conditions	
Operation	
Ambient temperature range	-40 °C ... +71 °C (encoder excluded)
Relative humidity, max.	95% (non-condensing)
IP protection level	IP65
Storage	
Ambient temperature range	-55 °C ... +85 °C (encoder excluded)
Relative humidity, max.	95% (non-condensing)

7 CHANNEL WAVEGUIDE COAX ROTARY JOINT | S-BAND / L-BAND

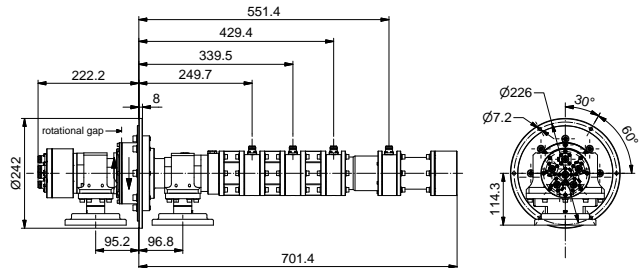

RF channel characteristics							
Channel designation	Channel 1	Channel 2	Channel 3	Channel 4	Channel 5	Channel 6	Channel 7
Interfaces	UG 585/U	N-f (50 Ω)					
Frequency range	2.7 - 3.1 GHz			1 - 1.1 GHz		2.7 - 3.1 GHz	
Peak power, max.	1.5 MW	10 kW					
Average power, max.	6 kW	75 W	75 W	300 W	100 W	50 W	75 W
VSWR, max.	1.2	1.25	1.25	1.2	1.2	1.2	1.25
VSWR WOW, max.	1.05	1.05	1.05	1.05	1.05	1.05	1.05
Insertion loss, max.	0.15 dB	0.7 dB	0.7 dB	0.7 dB	0.7 dB	0.7 dB	0.7 dB
Insertion loss WOW, max.	0.03 dB						
Isolation, min.	70 dB	60 dB					
Phase WOW, max.	1.5 deg.	2 deg.					

7 Channel

General mechanical data	
Differential operating pressure, max. / nom.	0.25 MPa (35 psi) / 0.01 MPa (1.4 psi)
Leakage rate, max.	50 cm ³ / minute
Rotating speed, max.	60 rpm
Life, min.	200 x 10 ⁶ revolutions
Maintenance period, min.	20 x 10 ⁶ revolutions
Starting torque, max.	3 Nm @ room temperature
Torque during rotation, max.	3 Nm @ room temperature
Case material	aluminium alloy
Case surface finish	chromate conversion coat per MIL-DTL-5541 type 1 or type 2 / painted
Weight, approx.	20 kg

General environmental conditions	
Operation	
Ambient temperature range	-55 °C ... +71 °C
Relative humidity, max.	95% (non-condensing)
IP protection level	IP65
Storage	
Ambient temperature range	-55 °C ... +85 °C
Relative humidity, max.	95% (non-condensing)

7 CHANNEL WAVEGUIDE COAX ROTARY JOINT | S-BAND / L-BAND

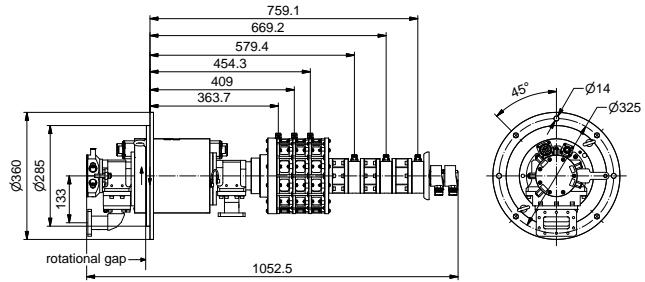

RF channel characteristics							
Channel designation	Channel 1	Channel 2	Channel 3	Channel 4	Channel 5	Channel 6	Channel 7
Interfaces	WR-284	N-f (50 Ω)					
Frequency range	2.7 - 2.9 GHz	2.7 - 3.1 GHz			1.0 - 1.11 GHz		
Peak power, max.	200 kW	10 kW			20 kW		
Average power, max.	3500 W	75 W			200 W		
VSWR, max.	1.2	1.25			1.3		
VSWR WOW, max.	0.05						
Insertion loss, max.	0.15 dB	1 dB	0.9 dB	0.9 dB	0.75 dB	0.75 dB	0.75 dB
Insertion loss WOW, max.	0.05 dB	0.1 dB					
Isolation, min.	70 dB	60 dB					
Phase WOW, max.	1.5 deg.	2 deg.					

Encoder characteristics	
Type / manufacturer	2 each DHO5S14/0B/2G29//16384//G6R BEI-Sensors, France

Slip rings characteristics	
Total number of ways	24

General mechanical data	
Differential operating pressure, max. / nom.	0.02 MPa (2.9 psi) / 0.014 MPa (2 psi)
Leakage rate, max.	25 cm ³ / minute
Rotating speed, max.	60 rpm
Life, min.	50 x 10 ⁶ revolutions
Maintenance period, min.	12.5 x 10 ⁶ revolutions
Starting torque, max.	10 Nm @ room temperature
Torque during rotation, max.	9 Nm @ room temperature
Case material	aluminium alloy
Case surface finish	chromate conversion coat per MIL-DTL-5541 type 1 or type 2 / painted
Weight, approx.	57 kg

General environmental conditions	
Operation	
Ambient temperature range	-40 °C ... +71 °C (encoder excluded)
Relative humidity, max.	95% (non-condensing)
IP protection level	IP65
Storage	
Ambient temperature range	-55 °C ... +85 °C (encoder excluded)
Relative humidity, max.	95% (non-condensing)

9 CHANNEL COAX ROTARY JOINT | L-BAND

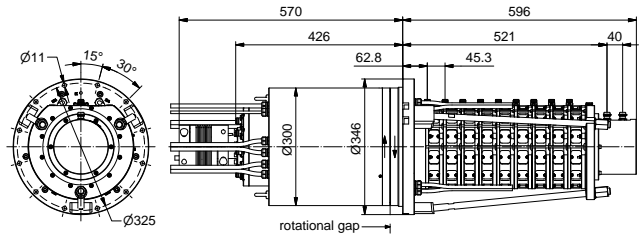

RF channel characteristics			
Channel designation	Channel 1	Channel 2 - 7	Channel 8 - 9
Interfaces		N-f (50 Ω)	
Frequency range	1.0 - 1.11 GHz	1.2 - 1.4 GHz	1.0 - 1.11 GHz
Peak power, max.		20 kW	
Average power, max.	500 W	200 W	180 W
VSWR, max. / typ.		1.3 / 1.25	
VSWR WOW, max.	0.05	0.1	0.05
Insertion loss, max. / typ.	0.7 dB / 0.6 dB	0.9 dB / 0.7 dB	0.9 dB / 0.8 dB
Insertion loss WOW, max.	0.03	0.05	
Isolation, min.		60 dB	
Phase WOW, max.	2 deg.	2 deg.	2 deg.

Encoder characteristics	
Type / manufacturer	2 x DHO5_14//RP29//3600 / BEI-IDEACOD, France

Slip rings characteristics	
Total number of ways	35

General mechanical data	
Rotating speed, max.	60 rpm
Life, min.	40 x 10 ⁶ revolutions
Maintenance period, min.	20 x 10 ⁶ revolutions
Starting torque, max.	34 Nm @ room temperature
Torque during rotation, max.	34 Nm @ room temperature
Case material	aluminium alloy / stainless steel
Case surface finish	chromate conversion coat per MIL-DTL-5541 type 1 or type 2 / painted
Weight, approx.	120 kg

General environmental conditions	
Operation	
Ambient temperature range	-40 °C ... +71 °C (encoder excluded)
Relative humidity, max.	95% (non-condensing)
IP protection level	IP65
Storage	
Ambient temperature range	-55 °C ... +85 °C (encoder excluded)
Relative humidity, max.	95% (non-condensing)

9 Channel



Company: _____ Contact Name: _____

Address: _____ Phone / Fax: _____

_____ E-Mail: _____ @ _____

Your Ref: _____ Date: _____

Project / Delivery Contry: _____

Application: military use | ground | airborne | space | RF rotary joint | FOJ rotary joint
 civil use | naval | other _____ | Media rotary joint | Encoder

Required Quantity: Prototype _____ Serial _____ Delivery Period: _____

RF CHANNEL CHARACTERISTICS - Total number of channels: <input type="text" value="...."/>						
Channel designation	1	2	3	4	5	6
Interfaces						
Style						
Frequency range						
Peak power, max.						
Average power, max.						
VSWR, max.						
VSWR WOW, max.						
Insertion loss, max.						
Insertion loss WOW, max.						
Phase WOW, max.						
Absolute phase difference						
Isolation, min.						
DC carrying capability, max.						

GENERAL MECHANICAL DATA	
Rotating speed, max.	rpm
Life, min. x revolutions
Starting torque, max.	Nm
Torque during rotation, max.	Nm
Case material	
Case surface finish, per MIL-C-5541	
Weight, approx.	kg

GENERAL ENVIRONMENTAL CONDITIONS	
Operation	
Ambient temperature range °C to °C
Relative humidity, max.	%
IP protection level	IP..
Storage	
Ambient temperature range °C to °C
Relative humidity, max.	%

DOCUMENTS REQUIRED	
CoC according DIN 55350-18	<input type="checkbox"/>
Government Source Inspection	<input type="checkbox"/>
Environmental Test	<input type="checkbox"/>
Other	<input type="checkbox"/>
.....	



FIBER OPTIC CHANNEL CHARACTERISTICS - Number of channels: <input type="text" value="...."/>	
Interface type	
Fiber type	<input type="checkbox"/> single mode <input type="checkbox"/> multi mode <input type="checkbox"/>
Jacket	
Data transmission lines / mode	
Wavelength	
Return loss, min.	dB
Insertion loss, max.	dB
Insertion loss WOW, max.	dB
Cross talk, min.	dB
Optical power, max.	mW / dBm

MEDIA ROTARY JOINT CHARACTERISTICS	Channel LINE IN	Channel LINE OUT
Operative system pressure (kPa)		
Over pressure peak for 15 sec (kPa), max.		
Added pressure drop in both lines at flow (kPa), max.		@ liters/min
Flow rate		liters/min
Backflow leakage, max.		liters/min
Liquid/air composition*		
Nominal liquid temperature (°C)		
Liquid temperature range, min./max. (°C)		
Particle size in liquid (µm), max.		

*eg: 40% water + 60% ethylene glycol + inhibitors

DESCRIPTION OF APPLICATION:



ELECTRICAL REQUIREMENTS - Total number of ways: <input type="text" value="...."/>						
Designation of groups	A	B	C	D	E	F
Number of ways per group						
Application						
Normal current	A	A	A	A	A	A
Maximum current / period						
Voltage	V	V	V	V	V	V
Frequency	kHz	kHz	kHz	kHz	kHz	kHz
Isolation resistance / 500 V DC						
Dielectrical strength						
Resistance (End to End)						
Noise	Ω	Ω	Ω	Ω	Ω	Ω
Crosstalk						
Insertion loss	dB	dB	dB	dB	dB	dB
Impedance						
VSWR, max.						
Protection earth						
Switch-off time						

GENERAL MECHANICAL DATA	
Average rotational speed, max.	rpm
Rotating speed, max.	rpm
Turning torque static, max.	Nm
Turning torque dynamic, max.	Nm
Surface finish	

REQUIRED QUALITY DOCUMENTS	
CoC according DIN 55350-18	<input type="checkbox"/>
Government source inspection	<input type="checkbox"/>
Environmental test	<input type="checkbox"/>
Other	<input type="checkbox"/>
.....	

DIMENSIONS / LIMITATION / CONDITIONS	
Outer diameter, max.	mm
Free inner bore	<input type="checkbox"/> yes, mm <input type="checkbox"/> no
Total length	mm
Weight, max.	kg

GENERAL ENVIRONMENTAL CONDITIONS	
Isolation (per EN60529)	
Vibration / Shock / Acceleration	

LIFE TIME MAINTENANCE	
Operation time / Duty cycle (Hour per time interval)	
Life, min. x revolutions
Maintenance x revolutions
Brush change x revolutions
Warranty conditions	



TYPE OF CONNECTION				
Rotor Stator	Rotor: Connector	<input type="checkbox"/>	Stator: Connector	<input type="checkbox"/>
	Cable	<input type="checkbox"/>	Cable	<input type="checkbox"/>
	Solder terminal	<input type="checkbox"/>	Solder terminal	<input type="checkbox"/>
	Screw terminal	<input type="checkbox"/>	Screw terminal	<input type="checkbox"/>
Length of cable		m		m
Mating connectors to be supplied	<input type="checkbox"/>			

DESCRIPTION OF APPLICATION:

TECHNICAL ANNEX

WR 650 / R 14 / WG 6

International
plain
IEC 60154-2
154 IEC-UDR 14
A 138,1
B 220,7
E 58,69
F 31,73
G 60,3
H 100
Hole I Ø8
Hole J
C 12,7
Material

USA
plain
EIA RS-271-A
CPR 650 F
A 138,09 (5.437)
B 220,65 (8.687)
E 58,7 (2.311)
F 31,73 (1.249)
G 60,3 (2.374)
H 100 (3.937)
Hole I Ø8,33 (Ø0.328)
Hole J
C
Material Cu, Al, Mg alloys

Origin
Flange style
Standard
Standards are listed together with their issue status. Exception: For lack of space the standard „IEC 60154-2: 1980 + A1: 1997“ has been depicted as „IEC 60154-2“
Flange designation
(historic AN designation, if available)
Simplified 3D scetch indicating the basic dimensions of the flange front
All dimensions are of nominal nature. They are not necessarily in the center of their tolerance band. Dimensional tolerances are not listed. Dimensions with decimal comma are in millimeters. Dimensions with decimal point are in inches.
Material

International
sealing groove
IEC 60154-2
154 IEC-PDR 14
A 138,1
B 220,7
E 58,69
F 31,73
G 60,3
H 100
Hole I Ø8
Hole J
C 12,7
Material

USA
sealing groove
EIA RS-271-A
CPR 650 G
A 138,09 (5.437)
B 220,65 (8.687)
E 58,7 (2.311)
F 31,73 (1.249)
G 60,3 (2.374)
H 100 (3.937)
Hole I Ø8,33 (Ø0.328)
Hole J
C
Material Cu, Al, Mg alloys

The summary of all rectangular waveguide flanges can be downloaded under the following link:



http://www.spinner-group.com/upload/TD_00077_2_2771.pdf

TECHNICAL ANNEX

WR 284 / R 32 / WG 10

USA	
sealing groove	
MIL-DTL-3922/52D	
M3922/52-032 (UG-1349/U)	
A	76,2 (3)
B	114,3 (4,5)
E	29,57 (1.164)
F	14,68 (0.578)
G	32,54 (1.281)
H	48,62 (1.914)
Hole I	Ø6,53 (Ø0.257)
Hole J	
C	9,65 (0.38)
Material	Al alloy

International	
plain	
IEC 60154-2	
154 IEC-UDR 32	
A	76,2
B	114,3
E	29,57
F	14,68
G	32,54
H	48,61
Hole I	Ø6,35
Hole J	
C	10
Material	

USA	
plain	
EIA RS-271-A	
CPR 284 F	
A	76,2 (3)
B	114,3 (4.5)
E	29,57 (0.164)
F	14,68 (0.578)
G	32,53 (1.281)
H	48,62 (1.914)
Hole I	Ø6,55 (Ø0.258)
Hole J	
C	
Material	Cu, Al, Mg alloys

USA	
choke/sealing groove	
MIL-DTL-3922/61E	
M3922/61-001 (UG-585A/U)	
A	134,94 (5.312)
B	
E	120,65 (4.750)
F	
G	
H	
Hole I	0.250-20 UNC-2B
Hole J	
C	31,75 (1.250)
Material	Al alloy

International	
sealing groove	
IEC 60154-2	
154 IEC-PDR 32	
A	76,2
B	114,3
E	29,57
F	14,68
G	32,54
H	48,61
Hole I	Ø6,35
Hole J	
C	10
Material	

USA	
plain	
EIA RS-271-A	
CPR 284 G	
A	76,2 (3)
B	114,3 (4.5)
E	29,57 (0.164)
F	14,68 (0.578)
G	32,53 (1.281)
H	48,62 (1.914)
Hole I	Ø6,55 (Ø0.258)
Hole J	
C	
Material	Cu, Al, Mg alloys

TECHNICAL ANNEX

GENERAL TERMS

Channel

Describes a physical transmission path having one port on the stator and one port on the rotor. Unlike in telecommunication engineering, this term does not describe a certain limited portion of the electro-magnetic spectrum when used in this context.

Contacting rotary joint

A rotary joint utilizing galvanic sliding contacts. Typically, wide-band designs are based on contacting coupling structures. Furthermore, contacting designs allow for DC transmission and can handle low frequency signals at limited space. Life is limited however (usually to some 10^6 to 10^7 revolutions) because of contact wear.

Hollow shaft module

A module with a clear inner bore along its axis of rotation. Usually hollow shaft modules are stackable to create multi channel rotary joints. The inner transmission lines of all neighboring modules are fed through the center bore.

Module

A basic rotary joint element (usually single channel). Multi channel designs are commonly comprised of several individual modules.

Non-contacting rotary joint

A rotary joint based on non-contacting coupling mechanisms like capacitive, inductive, transmission line or transformer coupling. Non-contacting rotary joints generally cover a limited bandwidth (typical relative bandwidth less than 40%; in most applications some 10 to 20%) because of frequency-dependent coupling mechanisms.

Non-contacting rotary joints offer superior product life time over contacting designs since contact wear is eliminated. Typical life figures are only limited by the bearing or sealing system and might be as high as several hundred millions of revolutions.

The transmission line coupling mechanism is usually limited to channels operating in the GHz frequency range because lower frequencies would result in large-sized coupling structures.

On-axis module (center module)

A module without a center bore. Commonly used as the final stacking element in multi channel units.

Rotary joint

A rotary transducer featuring an unlimited angle of rotation. SPINNER's design capabilities include systems for data, power and media transmission as radio frequency (RF) signals; electrical signals; fiber optical signals; electrical power and media like gases and liquids.

Rotary joints may also be equipped with further subsystems like angular encoders and revolution counters. Commonly a rotary joint is abbreviated as R/J, in case of fiber optical rotary joint as FORJ.

Rotor

Rotating portion of a rotary joint.

Slip ring

A particular variant of a contacting low frequency rotary joint, mostly equipped with a large-diameter center bore. Slip rings are based on ring and static brush systems and commonly used for power and signal transmission.

Slip ring assemblies for big multi channel rotary joints may feature some 100 ways and are often used to accommodate the (smaller) RF subsystems which are nested inside the slip ring's center bore.

Stator

Static portion of a rotary joint. Stators are not necessarily characterized by a mounting flange.

Swivel joint

Any rotary transducer featuring a limited angle of rotation.

RF CHANNEL CHARACTERISTICS

Attenuation and amplification

Attenuation is defined as the reduction of the transmitted energy of a signal in the course of a transmission link. Thus attenuation is negative amplification. Attenuation and amplification are usually specified in dB (decibel). Specifications in dB are „relative levels“. Here the notion „level“ means the comparison between a measured value and a reference value: The relative level of a transmission link is defined as follows: The level at a reference point, e. g. at the feeding point, is defined as 0 dB, regardless of the actual absolute level. The relative level at the end of the link is derived by adding the reference level and all transmission parameters of the elements of the transmission link (positive for amplifiers, negative for attenuation links).

Average power

Maximum permissible long term ("continuous wave" or CW) power which a component can handle safely without internal overheating.

During operation ohmic and dielectric losses generate heat inside the rotary joint. Hence, the maximum permissible average power is frequency-dependent.

The relation between heat generation and heat dissipation (by metallic feeder waveguides, casing, mounting flanges and air convection) determines the actual CW power that may be applied over a long period of time while still ensuring safe internal operating temperatures for all critical parts. Average power handling may be increased by additional forced cooling (air or water) and use of advanced materials or designs. Excessive ambient temperatures will degrade the average power capability respectively.

TECHNICAL ANNEX

DC carrying capability

Naturally, this parameter is only specified for contacting rotary joints. It describes the maximum DC current that can be safely transmitted over a rotary joint. This may be of relevance for applications where biased electronic assemblies are located close to the antenna. If high direct (or low frequency) current transfer is demanded, the RF power capability is usually compromised.

Because of the delicate nature of several contact parts inside most typical RF rotary joints the DC carrying capability is commonly limited to currents of a few amperes and to low voltages.

If higher DC or low frequency AC power transmission capabilities are desired, SPINNER encourages the use of slip ring assemblies particularly designed for this purpose.

Frequency range

Portion of the electromagnetic spectrum which a component has been designed for and within which the respective specification is valid. SPINNER offers designs for the entire frequency range between DC and the millimeter wave range.

Insertion loss

Attenuation of a signal being passed through a device within the signal path. Insertion loss a_i is usually expressed as the logarithmic ratio (in dB) between incident power P_{in} and output power P_{out} :

$$a_i = 10 \text{ dB} \cdot \log P_{in} / P_{out}$$

Internal transmission line structures, feeder waveguides or cables cause ohmic, dielectric and reflection losses. The dissipated energy results in heat generation and limits the maximum permissible long-term power rating. Generally speaking, long designs suffer from higher insertion loss than shorter ones and waveguide designs are usually superior to coaxial designs. Whenever there is a choice, the system waveguide size should be chosen as big as possible because of increased waveguide losses in the lower portion of their operating band.

Insertion loss is somewhat temperature-dependent. SPINNER would like to point out that any insertion loss figures stated in SPINNER data sheets hold true for the entire specified range of operating temperatures and the nominal operating power.

Most waveguide rotary joints feature insertion loss values in the 0.1 dB to 0.5 dB range, and so do usual coaxial designs without cables. Large multi channel rotary joints contain additional internal cables which may cause significant additional losses.

Any "insertion loss, max." figures given in SPINNER data sheets are worst-case values over the entire temperature range and rotation.

Insertion loss difference absolute

This parameter is only defined for two channels operating in the same frequency range. It describes the difference between their insertion loss figures at a certain frequency and at an identical rotational angle θ .

"Absolute insertion loss difference, max.", as given in SPINNER datasheets, describes the worst-case value over the rotational angle θ at the frequency f_{ILD} which delivers the maximum difference within the operating frequency band:

$$ILD_{max} = | a_{i,CH1}(\theta) - a_{i,CH2}(\theta) | @ f_{ILD}; \theta_{ILD}$$

If required careful tuning of the internal cable lengths enables insertion loss matching of channels within 0.1 to 0.2 dB (for coaxial multi channel rotary joints).

Insertion loss tracking over rotation

Insertion loss tracking is only defined for two channels operating in the same frequency range. It describes their insertion loss synchronism over rotation.

Two modules, each suffering from high insertion loss variation over rotation, can still result in a dual channel rotary joint with good insertion loss tracking since the two individual variations may be equal and therefore cancel out if combined properly.

This parameter could also be expressed as "variation of insertion loss difference over rotation".

"Insertion loss tracking, max.", as given in SPINNER datasheets, describes the worst-case value over the rotational angle θ at the frequency f_{ILD} which delivers the maximum variation of insertion loss difference within the operating frequency band:

$$ILT_{max} = | ILD_{max}(\theta) - ILD_{min}(\theta) | @ f_{ILT}; \theta_{ILT}$$

Insertion loss variation over rotation

Sometimes also named "insertion loss WOW", this parameter describes how much insertion loss changes over a full rotation at the "worst" frequency within the specified frequency range. For most technical applications this parameter is of higher relevance than VSWR variation.

"Insertion loss variation over rotation" is defined as the difference between the pair of insertion loss values ($a_{i,max}$ and $a_{i,min}$) measured at the frequency point f_{iL} which features the highest insertion loss variation over the rotational angle θ :

$$\Delta a_{i,max} = a_{i,max}(\theta) - a_{i,min}(\theta) @ f_{iL}$$

This definition of insertion loss variation can be depicted as the maximum distance between the two insertion loss plots taken at their "worst" and "best" rotational angles. Insertion loss variation is mostly a footprint of VSWR variation which in turn causes varying reflection losses.

Any "insertion loss variation over rotation, max." figures given in SPINNER data sheets are worst-case values (typically between 0.05 dB and 0.2 dB) and do already include a safety margin to consider instabilities of moved measurement lines.

TECHNICAL ANNEX

Interface orientation

Describes the basic style of a rotary joint depending on the orientation of both interfaces (rotor and stator).

Several waveguide designs may actually only be realized as "U" styles and must be adapted to the desired style using external waveguides.

- I-style: Both interfaces in line with the rotational axis.
- U-style: Both interfaces perpendicular to the rotational axis.
- L-style: Special arrangement of interface orientation, one interface is perpendicular to the rotational axis, the other interface is in line with the rotating axis.

Interface type

Generally, SPINNER RF rotary joints come with either waveguide or coaxial interfaces. The appropriate choice depends on application, frequency range and power rating requirements. Most waveguide rotary joints feature standardized waveguide interfaces according to IEC-154, MIL-DTL-3922 or EIA-RS 271, which may be either of the plain or choke type. Grooves on sealed flanges in combination with gaskets allow for pressurization and provide protection against ingress of dirt and moisture. Internal corners of waveguide interfaces are sometimes rounded for manufacturing reasons. These rounded corners have been designed carefully and thus are fully electrically compensated when mated to "real" rectangular standard waveguides.

Consequently, RF performance will not be compromised at all by the rounding. Coaxial designs are usually equipped with precision coaxial connectors according to IEEE Std 287-2007.

Isolation

Describes the crosstalk between two channels.

The amount of RF energy leaking from one channel to a second one is usually expressed as insertion loss (in dB) between one port of the first channel and another port of the second channel while all remaining ports are properly terminated. Depending on the choice of ports two different isolation types must be considered: Forward and reverse isolation.

All isolation values given by SPINNER represent worst-case values including both forward and reverse isolation. Typical values are some 50 to 70 dB while particular designs, especially waveguide rotary joints designed for exceptionally high power, allow for isolation values around 100 dB.

Peak power

Maximum permissible short term power which a component can handle safely without internal arcing or breakdown.

In contrast to "instantaneous values", this term refers to short-term RMS values within the pulse duration. Usual pulse durations are in the μs range. It should be pointed out that the actual peak power capability depends considerably on parameters such as absolute air pressure inside the component, load VSWR, temperature, pulse duration and pulse repetition time. Specifying the required operating pressure for a given peak power is of paramount importance. While low ambient air pressure will degrade the peak power capability, it can be massively enhanced

by a pressurization of all electrically stressed components with dry compressed air or particular insulation gases like SF₆. If space use is intended, a different vacuum discharge mechanism called "multipactor discharge" becomes crucial.

SPINNER datasheets provide all necessary information about these limiting conditions. Depending on the connector size, coaxial rotary joints usually feature peak power figures in the 1 to 10 kW range while typical values for unpressurized waveguide rotary joints might be as high as 10 kW to 1 MW (also depending on waveguide size). Peak power level is limited to the air pressure at sea level if not otherwise indicated.

Phase difference absolute

Like insertion loss difference, this parameter is only defined for two channels operating in the same frequency range. It describes the difference between their insertion phases at a certain frequency and at an identical rotational angle θ .

"Absolute phase difference, max.", as given in SPINNER datasheets, describes the worst-case value over the rotational angle θ at the frequency f_{PD} which delivers the maximum difference within the operating frequency band:

$$PD_{max} = | \varphi_{i,CH1}(\theta) - \varphi_{i,CH2}(\theta) | @ f_{PD}; \theta_{PD}$$

If required careful tuning of the internal cable lengths enables phase matching of channels within a few degrees (for coaxial multi channel designs, depending on wavelength).

Phase tracking over rotation

Phase tracking is only defined for two channels operating in the same frequency range. It describes their phase synchronism over rotation. Two modules, each suffering from high phase variation over rotation, can still result in a dual channel rotary joint with good phase tracking since the two individual variations may be equal and therefore cancel out if combined properly.

This parameter could also be expressed as "variation of phase difference over rotation".

"Phase tracking, max.", as given in SPINNER datasheets, describes the worst-case value over the rotational angle θ at the frequency f_{PT} which delivers the maximum variation of the phase difference within the operating frequency band:

$$PT_{max} = PD_{max}(\theta) - PD_{min}(\theta) @ f_{PT}; \theta_{PT}$$

Some applications, for example secondary surveillance radar (SSR), require well matched rotary joint channels (both insertion loss and phase) along with tracking requirements.

Phase variation over rotation

Phase variation over rotation or "phase WOW" describes how much the insertion phase of a rotary joint changes over a full rotation at the "worst" frequency within the specified frequency range. This parameter indicates a variation of the effective electric length. Along with insertion loss variation over rotation it is of higher relevance for most technical applications than VSWR variation.



TECHNICAL ANNEX

"Phase variation over rotation" is defined as the difference between the pair of insertion phase values ($\varphi_{i,max}$ and $\varphi_{i,min}$) measured at the frequency point f_{PV} which features the highest insertion loss variation over the rotational angle θ :

$$\Delta \varphi_{i,max} = \varphi_{i,max}(\theta) - \varphi_{i,min}(\theta) @ f_{PV}$$

This definition of insertion phase variation can be depicted as the maximum distance between the two insertion phase plots taken at their "worst" and "best" rotational angles. Any "phase variation over rotation, max." figures given in SPINNER data sheets are worst-case values (typically of the order of 0.5 to 5 degree) and do already include a safety margin to consider instabilities of moved measurement lines.

Return loss

Alternative representation of VSWR, describes the logarithmic ratio (in dB) between incident power P_{in} and reflected power P_r at a component's port:

$$a_r = 10 \text{ dB} \cdot \log P_{in}/P_r$$

The return loss a_r is infinite in the perfectly matched case and zero at total reflection. A high return loss figure is desirable and indicates a well matched component. Return loss values usually range from 10 dB to 40 dB.

Values, maximum and minimum

Maximum or minimum values represent guaranteed limit values which are not exceeded at any time or under any condition specified in the data sheet. Usually there is a safety margin between these guaranteed maximum limits and the values typically measured at room temperature.

Values, typical

In many cases SPINNER specifies both maximum and typical values.

Typical values are given whenever useful for a more realistic description of the performance. These values are typically observed on the majority of a production batch when measured under standard conditions. SPINNER does not guarantee these "typical values" however.

VSWR / reflection factor

When an electrical line is terminated by a load with its characteristic impedance a signal transmitted to the line is fully absorbed by the matching load. However, if the impedance of the termination differs from the characteristic impedance of the line the wave will be reflected more or less strongly. The reflection factor r is related to the complex impedance of the line, Z_0 , and the complex terminating impedance, Z :

$$r = \frac{Z - Z_0}{Z + Z_0}$$

The waves continuing along the line and reflected waves are overlaying to form standing waves. The amplitude relationship between the largest and the smallest voltage on a loss-free line is defined as the VSWR (Voltage Standing Wave Ratio):

$$VSWR = \frac{1 + |r|}{1 - |r|}$$

The reflection factor is often specified as the logarithmic value of the return loss:

$$\alpha = -20 \log(r) \text{ dB}$$

VSWR variation over rotation

Sometimes also named "VSWR WOW", this parameter describes how much VSWR changes over a full rotation at the "worst" frequency within the specified frequency range. SPINNER defines "VSWR variation over rotation" as the difference between the pair of VSWR values ($VSWR_{max}$ and $VSWR_{min}$) measured at the frequency point f_{VSWR} which features the highest VSWR variation over the rotational angle θ :

$$\Delta VSWR_{max} = VSWR_{max}(\theta) - VSWR_{min}(\theta) @ f_{VSWR}$$

This definition of VSWR variation can be depicted as the maximum distance between the two VSWR plots taken at their "worst" and "best" rotational angles. Common values are between 0.02 and 0.2.

Please note that alternative definitions exist for this parameter. The most popular one is the ratio between $VSWR_{max}$ and $VSWR_{min}$ and leads to values greater than one. Unless otherwise required by customers, SPINNER does not use these definitions.

GENERAL MECHANICAL DATA

Case material

The case material is the material of the housings and main flanges. For the internal design also other materials are used. Typical materials are aluminum alloy, copper alloy or stainless steel.

Case surface finish

The case surface finish is the surface treatment of the housings and main flanges. For the internal design also other surface treatments are used. Some joints do not have any surface treatments, other typical treatments are chromate conversion coat per MIL-DTL-5541 (e.g. Surtech 650), silver plated or painted (e.g. two-component paints, PU-based, color according to RAL or other specifications).

Interface loads

The interface loads coming from the installation of the rotary joint will have an effect on the bearing design. SPINNER rotary joints usually are not designed to with stand external forces; which means that no or no significant loads are allowed.

Leakage rate

Leakage rate for pressurized wave guides valid for the indicated operating ambient temperature range. Usually indicated as maximum value valid at the indicated nominal differential pressure.



TECHNICAL ANNEX

Life time

Life time is usually indicated in number of revolutions. Life time is limited by the type (contacting) of transmission as well as by bearings and dynamic seals. The life time can be extended by dedicated maintenance tasks, available for some products.

Marking

Marking or labeling of the rotary joint. Typical solutions are adhesive label, riveted label, laser engraving, engraving or stamping.

Operating pressure, absolute

Absolute pressure within the RF part of the rotary joint indicated in MPa and in bar. "Absolute operating pressure, min.", as given in SPINNER datasheets, describes the minimum pressure to be maintained in all operating conditions to ensure the peak power capability of the rotary joint. Depending on the type of insulating gas different minimum pressures need to be maintained.

Operating pressure, differential

Differential pressure between pressurized area within the RF part and environment indicated in MPa (10⁶ Pa) and in bar. "Differential operating pressure, max.", as given in SPINNER datasheets, is valid for the complete operating ambient temperature range. The term "Differential operating pressure, nominal" describes the recommended operating condition.

Rotating speed

Rotational speed in rpm. Usually indicated as nominal and maximum speed.

Torque

The torque of a rotary joint gives the mechanical resistance during start up or turning. Usually these two values are indicated in Nm for room temperature and for the minimum specified operating ambient temperature. If no temperature is indicated the torque is defined at room temperature. The room temperature is defined to 20 °C ±5 °C. Torque values for other temperatures can be given upon request.

Weight

Weight of rotary joint assembly without mounting screws and protective packing.

GENERAL ENVIRONMENTAL CHARACTERISTICS

Ambient temperature range

Temperature range of the environment in °C. Typically indicated for operating and for storage condition. If not otherwise indicated SPINNER assumes that no heat from external sources is introduced into the rotary joint.

Application

The application indicates the general environment of the installed rotary joint. The application is typically defined as airborne plane, airborne helicopter, ground fixed, ground mobile, shipboard, submarine, or satellite according to MIL-HDBK-217.

Degree of Protection and IP Classification

All IP classes in this catalogue are given in accordance to DIN EN 60529. Standard DIN EN 60529:1991 defines the protection ratings for the housings of electrical appliances. The given IP classes are valid for all installation directions if not indicated. To achieve the appropriate IP class the rotary joint must be installed correctly and fitted with appropriate gasket of connected appropriate.

The IP code is used for specifying the protection rating of a housing, e. g.:

IP23CH; IP = International Protection (Ingress Protection)

IP 2 3 C H

0-6 or X – against ingress of solid objects	
0 no special protection	
1 ≥ 50.0 mm ø	4 ≥ 1.0 mm ø
2 ≥ 12.5 mm ø	5 dust protection
3 ≥ 2.5 mm ø	6 dust tight
X replaces numeral if not applicable	

IP 2 3 C H

0-8 or X – against ingress of water	
0 no special protection	
1 vertically dripping	5 jetting
2 dripping (15° tilted)	6 powerful jetting
3 spraying	7 temporary immersion
4 splashing	8 continuous immersion
X replaces numeral if not applicable	

IP 2 3 C H

optional – A,B,C,D – against access to hazardous parts	
A	back of hand
B	finger
C	tool
D	wire

IP 2 3 C H

optional – H, M, S, W – supplementary information specific for:	
H	high voltage equipment
M	motion during water test
S	stationary during water test
W	weather conditions

Fungus

Information for the compliance demonstration according to MIL-STD-810G, Method 508 "Fungus".

Icing/Freezing Rain

Information for the compliance demonstration according to MIL-STD-810G, Method 521 "Icing/Freezing Rain".



TECHNICAL ANNEX

Rain

Information for the compliance demonstration according to MIL-STD-810G, Method 506 “Rain”.

Relative humidity

The ratio of the actual vapor pressure of the air to the saturation vapor pressure in %. Typically indicated as a maximum value, valid for the complete temperature range. It must be ensured that condensing will not appear.

Sand and Dust

Information for the compliance demonstration according to MIL-STD-810G, Method 510 “Dust”.

Salt fog

Information for the compliance demonstration according to MIL-STD-810G, Method 509 “Salt Fog”.

Shock

Information for the compliance demonstration according to MIL-STD-810G, Method 516 “Shock”.

Vibration

Information for the compliance demonstration according to MIL-STD-810G, Method 514 “Vibration”.

UNIT CONVERSION

Barometric formula (Atmospheric Pressure versus Altitude)

Atmospheric pressure $\frac{p_h}{Pa}$	$p_h = 1013.25hPa \left(1 - \frac{0.0065 \cdot h}{288.15m}\right)^{5.255}$
Altitude $\frac{h}{m}$	$h = \frac{\left(1 - \left(\frac{p_h}{1013.25hPa}\right)^{\frac{1}{5.255}}\right) \cdot 288.15}{0.0065} m$

Conditions:

- Standard temperature lapse rate: 0.0065 K·m⁻¹
- Standard temperature (sea level): 15 °C = 288.15 K
- Static pressure (sea level): 1013.25 hPa
- Gravitational acceleration: 9.807 m·s⁻²
- Molar mass of Earth's air: 0.02896 kg/mol
- Universal gas constant for air: 8.314 J·(K·mol)⁻¹

High (m)	Pressure (hPa)	High (m)	Pressure (hPa)
0	1013.25	4000	616.45
500	954.61	4500	577.33
1000	898.76	5000	540.25
1500	845.58	6000	471.87
2000	794.98	7000	410.66
2500	746.86	8000	356.06
3000	701.12	9000	307.48
3500	657.68	10000	264.42

Force

	Newton (N)	Pound-force (lbf)
1 N	1.0	224.8 · 10 ⁻³
1 lbf	4.448	1.0

Torque

	Newton meter (Nm)	Pound-force foot (lbf-ft)	Ounce-force inch (ozf-in)	Pound-force inch (lbf-in)
1 Nm	1.0	0.738	141.6	8.851
1 lbf-ft	1.356	1.0	192.0	12.0
1 ozf-in	7.062 · 10 ⁻³	5.208 · 10 ⁻³	1.0	62.5 · 10 ⁻³
1 lbf-in	0.113	83.333 · 10 ⁻³	16.0	1.0

Leak rate and mass flow rate

	Millibar liter per second (T_n) *	Cubic centimeter per second (T_n, p_n)	Pascal liter per second (T_n)	Torr liter per second (T_n)	Kilogram per hour x air (20 °C)	Mole per second
1 $\frac{mbar \cdot l}{s}$	$1 \frac{mbar \cdot l}{s} (T_n)$	$0.9869 \frac{cm^3}{s} (T_n, p_n)$	$100 \frac{Pa \cdot l}{s} (T_n)$	$0.75 \frac{Torr \cdot l}{s} (T_n)$	$4.3 \cdot 10^{-3} \frac{kg}{h} \text{ air}(20 \text{ °C})$	$4.41 \cdot 10^{-5} \frac{mol}{s}$
1 $\frac{cm^3}{s} (T_n, p_n)$	$1.01 \frac{mbar \cdot l}{s} (T_n)$	$1 \frac{cm^3}{s} (T_n, p_n)$	$101 \frac{Pa \cdot l}{s} (T_n)$	$0.76 \frac{Torr \cdot l}{s} (T_n)$	$4.3 \cdot 10^{-3} \frac{kg}{h} \text{ air}(20 \text{ °C})$	$4.45 \cdot 10^{-5} \frac{mol}{s}$
1 $\frac{Pa \cdot l}{s} (T_n)$	$1 \cdot 10^{-2} \frac{mbar \cdot l}{s} (T_n)$	$\sim 1 \cdot 10^{-2} \frac{cm^3}{s} (T_n, p_n)$	$1 \frac{Pa \cdot l}{s} (T_n)$	$7.5 \cdot 10^{-3} \frac{Torr \cdot l}{s} (T_n)$	$4.3 \cdot 10^{-3} \frac{kg}{h} \text{ air}(20 \text{ °C})$	$4.41 \cdot 10^{-7} \frac{mol}{s}$
1 $\frac{Torr \cdot l}{s} (T_n)$	$1.33 \frac{mbar \cdot l}{s} (T_n)$	$1.32 \frac{cm^3}{s} (T_n, p_n)$	$133 \frac{Pa \cdot l}{s} (T_n)$	$1 \frac{Torr \cdot l}{s} (T_n)$	$5.7 \cdot 10^{-3} \frac{kg}{h} \text{ air}(20 \text{ °C})$	$5.87 \cdot 10^{-5} \frac{mol}{s}$
1 $\frac{kg}{h} \text{ air}(20 \text{ °C})$	$230 \frac{mbar \cdot l}{s} (T_n)$	$230 \frac{cm^3}{s} (T_n, p_n)$	$2.3 \cdot 10^4 \frac{Pa \cdot l}{s} (T_n)$	$175 \frac{Torr \cdot l}{s} (T_n)$	$1 \frac{kg}{h} \text{ air}(20 \text{ °C})$	$1.01 \cdot 10^{-2} \frac{mol}{s}$
1 $\frac{mol}{s}$	$2.27 \cdot 10^4 \frac{mbar \cdot l}{s} (T_n)$	$2.25 \cdot 10^4 \frac{cm^3}{s} (T_n, p_n)$	$2.26 \cdot 10^6 \frac{Pa \cdot l}{s} (T_n)$	$1.7 \cdot 10^4 \frac{Torr \cdot l}{s} (T_n)$	$99 \frac{kg}{h} \text{ air}(20 \text{ °C})$	$1 \frac{mol}{s}$

* 1 mbar·l·s⁻¹ (T_n) equates to 0.9869 cm³ of an ideal gas in standard reference conditions; 1 mbar·l·s⁻¹ (T_n) = 4.41·10⁻⁵ mol s⁻¹
 Standard reference conditions: T_n = 0 °C, p_n = 1013.25 mbar

$$\frac{p \cdot V}{T} = const$$



TECHNICAL ANNEX

Length

	Meter	Millimeter	Inch	Mil	Foot	Yard	Mile*
1 m	1.0	1000.0	39.37	39370.0	3.2808	1.0936	621.371 x 10 ⁻⁶
1 mm	0.001	1.0	0.03937	39.37	3.281 x 10 ⁻³	1.0936 x 10 ⁻³	621.371 x 10 ⁻⁹
1 in	25.4 x 10 ⁻³	25.4	1.0	1000.0	1/12.0	1/36	15.783 x 10 ⁻⁶
1 mil	25.4 x 10 ⁻⁶	25.4 x 10 ⁻³	0.001	1.0	1/12000.0	1/36000	15.783 x 10 ⁻⁹
1 ft	0.3048	304.8	12.0	12000.0	1.0	1/3	189.394 x 10 ⁻⁶
1 yd	0.9144	914.4	36.0	36000.0	3.0	1.0	568.182 x 10 ⁻⁶
1 mi	1609.344	1609344.0	63360.0	63.36 x 10 ⁻⁶	5280.0	1760.0	1.0

* 1 mile (mi) ≠ 1 nautical mile, 1 nautical mile = 1852 meter
 was adopted by the First International Extraordinary Hydrographic Conference, Monaco, 1929, under the name "International nautical mile"

Mass

	Kilogram	Gram	Ounce	Pound
1 kg	1.0	1000.0	35.27	2.205
1 g	0.001	1.0	35.27 x 10 ⁻³	2.205 x 10 ⁻³
1 oz	28.35 x 10 ⁻³	28.35	1.0	1/16
1 lb	453.6 x 10 ⁻³	453.6	16.0	1.0

Pressure

	Pascal (Pa)	Bar	Pound-force per square inch (psi)
1 Pa	1.0	10 x 10 ⁻⁶	0.145 x 10 ⁻³
1 bar	0.1 x 10 ⁶	1.0	14.5
1 psi	6.895 x 10 ³	68.95 x 10 ⁻³	10.0

Temperature

to from	degree Celsius (°C)	Kelvin (K)	degree Fahrenheit (°F)
$\frac{T}{^{\circ}\text{C}}$	$= \frac{T}{^{\circ}\text{C}}$	$= \frac{T}{\text{K}} - 273.15$	$= (\frac{T}{^{\circ}\text{F}} - 32) \cdot \frac{5}{9}$
$\frac{T}{\text{K}}$	$= \frac{T}{^{\circ}\text{C}} + 273.15$	$= \frac{T}{\text{K}}$	$= (\frac{T}{^{\circ}\text{F}} + 459.67) \cdot \frac{5}{9}$
$\frac{T}{^{\circ}\text{F}}$	$= \frac{T}{^{\circ}\text{C}} \cdot 1.8 + 32$	$= \frac{T}{\text{K}} \cdot 1.8 - 459.67$	$= \frac{T}{^{\circ}\text{F}}$



TECHNICAL ANNEX

Translation dBm into Watt

+90 dBm	1.000 000 W	10 ⁶	1 Megawatt
+80 dBm	100.000 W	10 ⁵	100 Kilowatt
+70 dBm	10.000 W	10 ⁴	10 Kilowatt
+60 dBm	1.000 W	10 ³	1 Kilowatt
+50 dBm	100 W	10 ²	100 Watt
+40 dBm	10 W	10 ¹	10 Watt
+30 dBm	1 W	10 ⁰	1 Watt
+20 dBm	0.1 W	10 ⁻¹	100 Milliwatt
+10 dBm	0.01 W	10 ⁻²	10 Milliwatt
0 dBm	0.001 W	10 ⁻³	1 Milliwatt
-10 dBm	0.000 1 W	10 ⁻⁴	100 Microwatt
-20 dBm	0.000 01 W	10 ⁻⁵	10 Microwatt
-30 dBm	0.000 001 W	10 ⁻⁶	1 Microwatt
-40 dBm	0.000 000 1 W	10 ⁻⁷	100 Nanowatt
-50 dBm	0.000 000 01 W	10 ⁻⁸	10 Nanowatt
-60 dBm	0.000 000 001 W	10 ⁻⁹	1 Nanowatt

Torque

	Newton meter (Nm)	Pound-force foot (lbf-ft)	Ounce-force inch (ozf-in)	Pound-force inch (lbf-in)
1 Nm	1.0	0.738	141.6	8.851
1 lbf-ft	1.356	1.0	192.0	12.0
1 ozf-in	7.062·10 ⁻³	5.208·10 ⁻³	1.0	62.5·10 ⁻³
1 lbf-in	0.113	83.333·10 ⁻³	16.0	1.0

Volume (fluid)

	Cubic meter (m ³)	Liter* (l)	Gallon, U.S. (gal)	Cubic inch (in ³)	Pint, U.S. liquid (pt)
1 m³	1.0	1000	264.2	61024	2113
1 l	10 ⁻³	1	0.264	61.02	2.113
1 gal	3.785 x 10 ⁻³	3.785	1	231	8
1 in³	16.39 x 10 ⁻⁶	16.39 x 10 ⁻³	4.329 x 10 ⁻³	1	34.63 x 10 ⁻³
1 liq pt	473.2 x 10 ⁻⁶	0.4732	1/8	28.875	1

* In 1964 the General Conference on Weights and Measures reestablished the name "liter" as a special name for the cubic decimeter. Between 1901 and 1964 the liter was slightly larger (1.000 028 dm³); when one uses high-accuracy volume data of that time, this fact must be kept in mind. The recommended symbol for the liter in the United States is L.



TECHNICAL ANNEX

Waveguide designations			Internal dimensions		Frequency		Band	
IEC ¹	EIA ²	UK ³	Metric ¹ mm	Imperial ¹ inches	Nominal range ¹ GHz	TE ₁₀ cut-off ⁴ GHz	Most common use	Other common use
R 3	WR 2300	WG 00	584.20 x 292.10	23.000 x 11.500	0.32 - 0.49	0.257	-	-
R 4	WR 2100	WG 0	533.40 x 266.70	21.000 x 10.500	0.35 - 0.53	0.281	-	-
R 5	WR 1800	WG 1	457.20 x 228.60	18.000 x 9.000	0.41 - 0.62	0.328	-	-
R 6	WR 1500	WG 2	381.00 x 190.50	15.000 x 7.500	0.49 - 0.75	0.393	-	-
R 8	WR 1150	WG 3	292.10 x 146.05	11.500 x 5.750	0.64 - 0.98	0.513	-	-
R 9	WR 975	WG 4	247.65 x 123.82	9.750 x 4.875	0.76 - 1.15	0.605	-	-
R 12	WR 770	WG 5	195.58 x 97.79	7.700 x 3.850	0.96 - 1.46	0.766	-	-
R 14	WR 650	WG 6	165.10 x 82.55	6.500 x 3.250	1.13 - 1.73	0.908	L	-
R 18	WR 510	WG 7	129.54 x 64.77	5.100 x 2.550	1.45 - 2.20	1.157	-	-
R 22	WR 430	WG 8	109.22 x 54.61	4.300 x 2.150	1.72 - 2.61	1.372	-	Ls, R
R 26	WR 340	WG 9A	86.36 x 43.18	3.400 x 1.700	2.17 - 3.30	1.736	-	-
R 32	WR 284	WG 10	72.14 x 34.04	2.840 x 1.340	2.60 - 3.95	2.078	S	-
R 40	WR 229	WG 11A	58.17 x 29.08	2.290 x 1.145	3.22 - 4.90	2.577	-	-
R 48	WR 187	WG 12	47.549 x 22.149	1.872 x 0.872	3.94 - 5.99	3.152	C	G
R 58	WR 159	WG 13	40.386 x 20.193	1.590 x 0.795	4.64 - 7.05	3.712	-	C
R 70	WR 137	WG 14	34.849 x 15.799	1.372 x 0.622	5.38 - 8.17	4.301	-	Xn, J
R 84	WR 112	WG 15	28.499 x 12.624	1.122 x 0.497	6.57 - 9.99	5.260	-	Xb, H
R 100	WR 90	WG 16	22.860 x 10.160	0.900 x 0.400	8.20 - 12.5	6.557	X	-
R 120	WR 75	WG 17	19.050 x 9.525	0.750 x 0.375	9.84 - 15.0	7.869	-	M
R 140	WR 62	WG 18	15.799 x 7.899	0.622 x 0.311	11.9 - 18.0	9.488	Ku	P
R 180	WR 51	WG 19	12.954 x 6.477	0.510 x 0.255	14.5 - 22.0	11.571	-	N
R 220	WR 42	WG 20	10.668 x 4.318	0.420 x 0.170	17.6 - 26.7	14.051	K	-
R 260	WR 34	WG 21	8.636 x 4.318	0.340 x 0.170	21.7 - 33.0	17.357	-	-
R 320	WR 28	WG 22	7.112 x 3.556	0.280 x 0.140	26.3 - 40.0	21.077	Ka	R
R 400	WR 22	WG 23	5.690 x 2.845	0.224 x 0.112	32.9 - 50.1	26.344	Q	-
R 500	WR 19	WG 24	4.775 x 2.388	0.188 x 0.094	39.2 - 59.6	31.392	U	-
R 620	WR 15	WG 25	3.759 x 1.880	0.148 x 0.074	49.8 - 75.8	39.877	V	-
R 740	WR 12	WG 26	3.099 x 1.549	0.122 x 0.061	60.5 - 91.9	48.372	E	-
R 900	WR 10	WG 27	2.540 x 1.270	0.100 x 0.050	73.8 - 112.0	59.014	W	-
R 1200	WR 8	WG 28	2.032 x 1.016	0.080 x 0.040	92.2 - 140.0	73.768	F	-
R 1400	WR 7 ⁵ (WR 6.5)	WG 29	1.6510 x 0.8255	0.0650 x 0.0325	113.0 - 1730	90.791	D	-
R 1800	WR 5 (WR 5.1)	WG 30	1.2954 x 0.6477	0.0510 x 0.0255	145.0 - 220.0	115.71	G	-
R 2200	WR 4 (WR 4.3)	WG 31	1.0922 x 0.5461	0.0430 x 0.0215	172.0 - 261.0	137.24	-	-
R 2600	WR 3 (WR 3.4)	WG 32	0.8636 x 0.4318	0.0340 x 0.0170	217.0 - 330.0	173.57	-	-

¹ IEC 153-2, Hollow metallic waveguides, Part 2: Relevant specifications for ordinary rectangular waveguides, Standard of the International Electrotechnical Commission, 1974

² EIA RS-261-B, Rectangular Waveguides (WR 3 to WR 2300), Standard of the Electronic Industries Association of the USA, May 1979

³ MOD UK DEF-5351, Specification for Tubing, Waveguide; Standard of the Ministry of Defence of the United Kingdom

⁴ The cut-off frequency is given by $f_c = c_0 / (2a)$ with $c_0 = 299792458 \text{ ms}^{-1}$ and the waveguide width

⁵ This waveguide is sometimes referred to as WR 6



VSWR CONVERSION TABLE

VSWR	Reflection (r)	Return loss (dB)	VSWR	Reflection (r)	Return loss (dB)
1.010	0.005	46.1	1.430	0.177	15.0
1.015	0.007	42.6	1.440	0.180	14.9
1.020	0.010	40.1	1.450	0.184	14.7
1.025	0.012	38.2	1.460	0.187	14.6
1.030	0.015	36.6	1.470	0.190	14.4
1.035	0.017	35.3	1.480	0.194	14.3
1.040	0.020	34.2	1.490	0.197	14.1
1.045	0.022	33.1	1.500	0.200	14.0
1.050	0.024	32.3	1.510	0.203	13.8
1.055	0.027	31.4	1.520	0.206	13.7
1.060	0.029	30.7	1.530	0.209	13.6
1.065	0.031	30.0	1.540	0.213	13.4
1.070	0.034	29.4	1.550	0.216	13.3
1.075	0.036	28.8	1.560	0.219	13.2
1.080	0.038	28.3	1.570	0.222	13.1
1.085	0.041	27.8	1.580	0.225	13.0
1.090	0.043	27.3	1.590	0.228	12.8
1.095	0.045	26.9	1.600	0.231	12.7
1.100	0.048	26.4	1.610	0.234	12.6
1.110	0.052	25.7	1.620	0.237	12.5
1.120	0.057	24.9	1.630	0.240	12.4
1.130	0.061	24.3	1.640	0.242	12.3
1.140	0.065	23.7	1.650	0.245	12.2
1.150	0.070	23.1	1.660	0.248	12.1
1.160	0.074	22.6	1.670	0.251	12.0
1.170	0.078	22.1	1.680	0.254	11.9
1.180	0.083	21.7	1.690	0.257	11.8
1.190	0.087	21.2	1.700	0.259	11.7
1.200	0.091	20.8	1.710	0.262	11.6
1.210	0.095	20.4	1.720	0.265	11.5
1.220	0.099	20.1	1.730	0.267	11.5
1.230	0.103	19.7	1.740	0.270	11.4
1.240	0.107	19.4	1.750	0.273	11.3
1.250	0.111	19.1	1.760	0.275	11.2
1.260	0.115	18.8	1.770	0.278	11.1
1.270	0.119	18.5	1.780	0.281	11.0
1.280	0.123	18.2	1.790	0.283	11.0
1.290	0.127	17.9	1.800	0.286	10.9
1.300	0.130	17.7	1.810	0.288	10.8
1.310	0.134	17.4	1.820	0.291	10.7
1.320	0.138	17.2	1.830	0.293	10.7
1.330	0.142	17.0	1.840	0.296	10.6
1.340	0.145	16.8	1.850	0.298	10.5
1.350	0.149	16.5	1.860	0.301	10.4
1.360	0.153	16.3	1.870	0.303	10.4
1.370	0.156	16.1	1.880	0.306	10.3
1.380	0.160	15.9	1.890	0.308	10.2
1.390	0.163	15.7	1.900	0.310	10.2
1.400	0.167	15.6	1.910	0.313	10.1
1.410	0.170	15.4	1.920	0.315	10.0
1.420	0.174	15.2	1.930	0.317	10.0

On our website you will find a VSWR converter tool under the Downloads section.

SPINNER GmbH
Erzgiessereistr. 33
80335 München
GERMANY
tel.: +49 89 12601-0
fax: +49 89 12601-1292
info@spinner-group.com

SPINNER ICT, Inc.
5126 S. Royal Atlanta Drive
Tucker, GA 30084-3052
USA
tel.: +1 770 2636 326
fax: +1 770 9343 384
info@spinner-group.com

SPINNER Austria GmbH
Triester Str. 190
1230 Wien
AUSTRIA
tel.: +43 1 66277 51
fax: +43 1 66277 5115
info-austria@spinner-group.com

**SPINNER Telecommunication
Devices Co., Ltd.**
351 Lian Yang Road
Songjiang Industrial Zone
Shanghai
201613 P.R. **CHINA**
tel.: +86 21 577 45377
fax: +86 21 577 40962
info-china@spinner-group.com

SPINNER France S.A.R.L.
1, Place du Village
Parc des Barbanniers
92632 Gennevilliers Cedex
FRANCE
tel.: +33 1 41479 600
fax: +33 1 41479 606
info-france@spinner-group.com

SPINNER Elektrotechnik OOO
Kozhevničeskaja str. 1, bld. 1
Office 420
115114 Moscow
RUSSIA
tel.: + 7 495 6385 321
fax: + 7 495 2353 358
info-russia@spinner-group.com

SPINNER Electrotécnica S.L.
c/ Perú, 4 – Local nº 15
28230 Las Rozas (MADRID)
SPAIN
tel.: +34 91 6305 842
fax: +34 91 6305 838
info-iberia@spinner-group.com

SPINNER Nordic AB
Kråketorpsgatan 20
43153 Mölndal
SWEDEN
tel.: +46 31 7061670
fax: +46 31 7061679
info-nordic@spinner-group.com

SPINNER UK Ltd.
Suite 8 Phoenix House
Golborne Enterprise Park,
High Street
Golborne, Warrington
WA3 3DP
UNITED KINGDOM
tel.: +44 1942 275222
fax: +44 1942 275221
info-uk@spinner-group.com