

## 200mW, Low VF SMD Schottky Barrier Diode

### FEATURES

- Designed for mounting on small surface
- Low Capacitance
- Low forward voltage drop
- Compliant to RoHS directive 2011/65/EU and in accordance to WEEE 2002/96/EC
- Halogen-free according to IEC 61249-2-21

### APPLICATIONS

- Adapters
- For switching power supply
- Low stored charge
- Inverter

### MECHANICAL DATA

- Case: SOT-23
- Molding compound: UL flammability classification rating 94V-0
- Moisture sensitivity level: level 1, per J-STD-020
- Packing code with suffix "G" means green compound (halogen-free)
- Terminal: Matte tin plated leads, solderable per J-STD-002
- Meet JESD 201 class 1A whisker test
- Weight: 8 mg (approximately)

KEY PARAMETERS		
PARAMETER	VALUE	UNIT
$I_{F(AV)}$	200	mA
$V_{RRM}$	40	V
$I_{FSM}$	0.6	A
$V_F$ at $I_F=40mA$	1	V
$T_J$ Max.	125	°C
Package	SOT-23	



ABSOLUTE MAXIMUM RATINGS ( $T_A = 25^\circ\text{C}$ unless otherwise noted)				
PARAMETER		SYMBOL	PART NUMBER	UNIT
Marking code on the device	BAS40		43	
	BAS40-04		44	
	BAS40-05		45	
	BAS40-06		46	
Repetitive peak reverse voltage		$V_{RRM}$	40	V
Forward current		$I_{F(AV)}$	200	mA
Non-repetitive peak forward surge current @ $t = 8.3ms$		$I_{FSM}$	0.6	A
Junction temperature range		$T_J$	-65 to +125	°C
Storage temperature range		$T_{STG}$	-65 to +125	°C

<b>THERMAL PERFORMANCE</b>			
<b>PARAMETER</b>	<b>SYMBOL</b>	<b>LIMIT</b>	<b>UNIT</b>
Junction-to-ambient thermal resistance	$R_{\theta JA}$	357	°C/W

<b>ELECTRICAL SPECIFICATIONS</b> ( $T_A = 25^\circ\text{C}$ unless otherwise noted)					
<b>PARAMETER</b>	<b>CONDITIONS</b>	<b>SYMBOL</b>	<b>MIN</b>	<b>MAX</b>	<b>UNIT</b>
Forward voltage per diode <sup>(1)</sup>	$I_F = 1\text{mA}, T_J = 25^\circ\text{C}$	$V_F$	-	0.38	V
	$I_F = 40\text{mA}, T_J = 25^\circ\text{C}$			1.00	
Reverse current @ rated $V_R$ per diode <sup>(2)</sup>	$V_R = 30\text{V}, T_J = 25^\circ\text{C}$	$I_R$	-	0.2	$\mu\text{A}$
Reverse Breakdown Voltage	$I_R = 10\mu\text{A}$	$V_{(BR)}$	40	-	V
Junction capacitance	1 MHz, $V_R = 1\text{V}$	$C_J$	-	5.0	pF
Reverse Recovery Time	$I_F = I_R = 10\text{mA}, R_L = 100\Omega,$ $I_{RR} = 1\text{mA}$	$t_{rr}$	-	5.0	ns

**Notes:**

1. Pulse test with  $PW = 0.3\text{ ms}$
2. Pulse test with  $PW = 30\text{ ms}$

<b>ORDERING INFORMATION</b>				
<b>PART NO.</b>	<b>PACKING CODE</b>	<b>PACKING CODE SUFFIX(*)</b>	<b>PACKAGE</b>	<b>PACKING</b>
BAS40-XX (Note 1)	RF	G	SOT-23	3K / 7" Reel

**Notes:**

1. "XX" is Device code from "04" to "06".

\*: optional available

<b>EXAMPLE</b>				
<b>EXAMPLE P/N</b>	<b>PART NO.</b>	<b>PACKING CODE</b>	<b>PACKING CODE SUFFIX</b>	<b>DESCRIPTION</b>
BAS40-04 RFG	BAS40-04	RF	G	Green compound

**CHARACTERISTICS CURVES**

( $T_A = 25^\circ\text{C}$  unless otherwise noted)

**Fig. 1 Power Derating Curve**

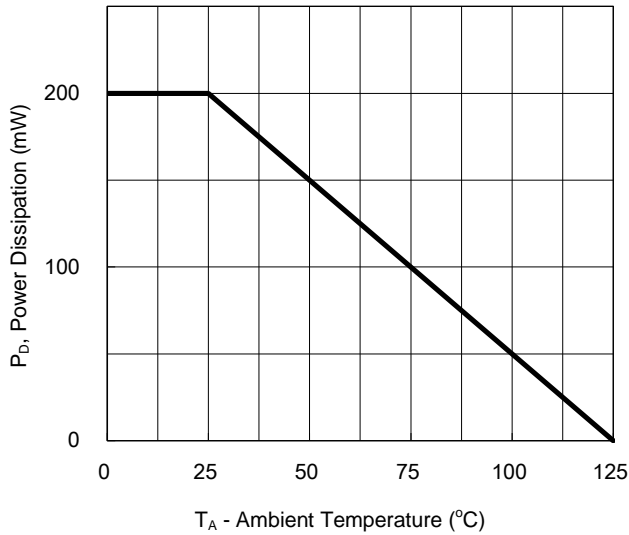

**Fig.2 Maximum Non-Repetitive Peak Forward Surge Current Per Leg**

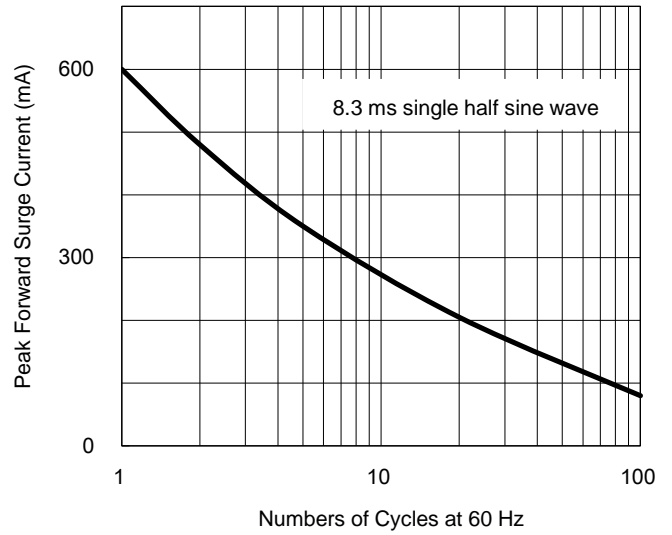

**Fig.3 Typical Forward Characteristics**

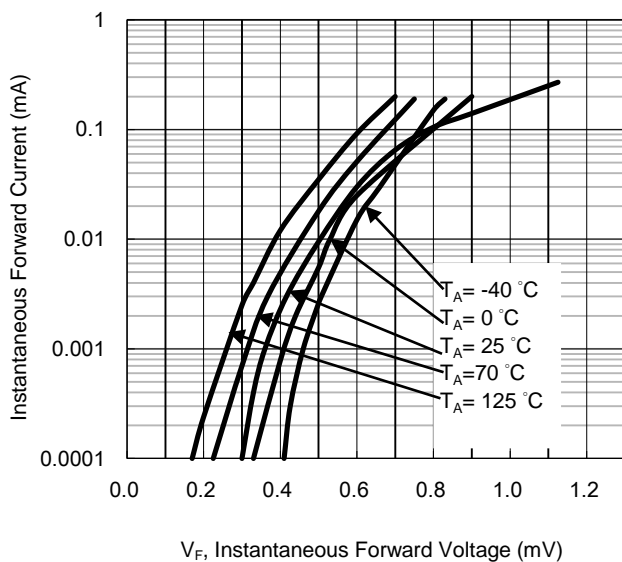

**Fig.4 Typical Reverse Characteristics**

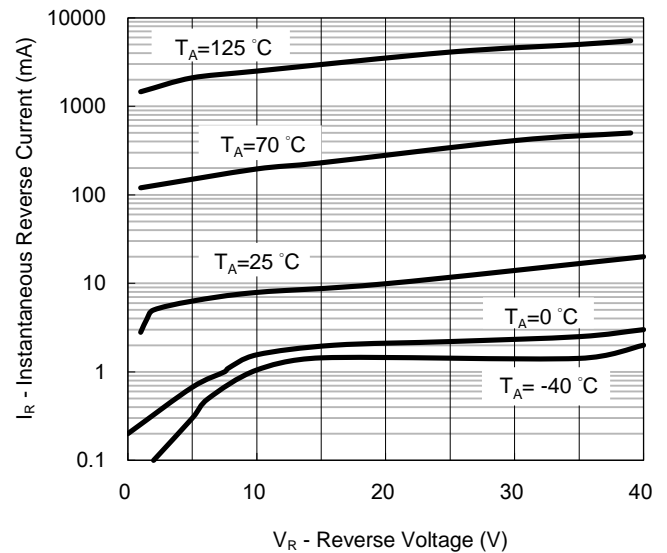

**CHARACTERISTICS CURVES**

( $T_A = 25^\circ\text{C}$  unless otherwise noted)

**Fig. 5 Typical Total Capacitance VS. Reverse Voltage**

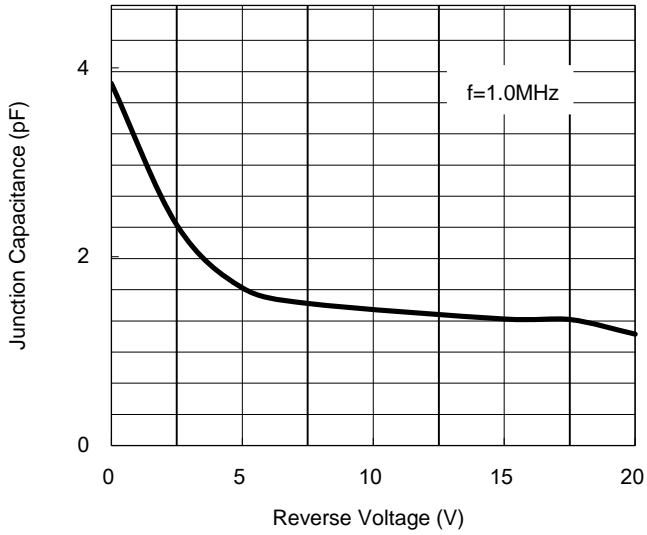

**Fig.6 Typical Transient Thermal Characteristics**

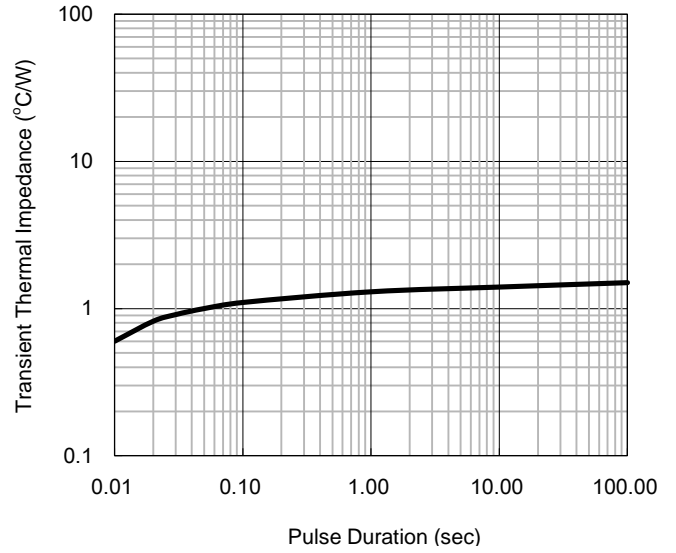

**PACKAGE OUTLINE DIMENSION**

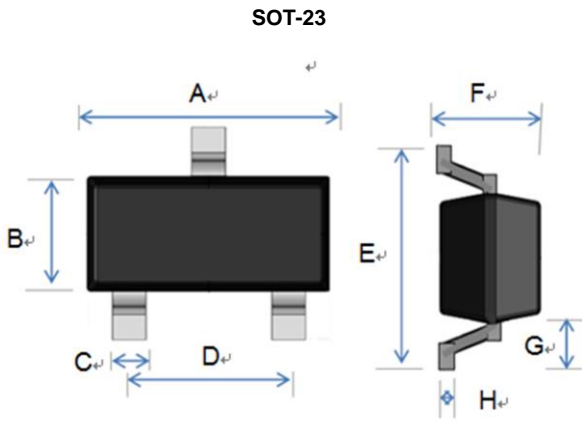

DIM.	Unit(mm)		Unit(inch)	
	Min	Max	Min	Max
A	2.70	3.10	0.106	0.122
B	1.10	1.50	0.043	0.059
C	0.30	0.51	0.012	0.020
D	1.78	2.04	0.070	0.080
E	2.10	2.64	0.083	0.104
F	0.89	1.30	0.035	0.051
G	0.55 REF		0.022 REF	
H	0.10 REF		0.004 REF	

**SUGGEST PAD LAYOUT**

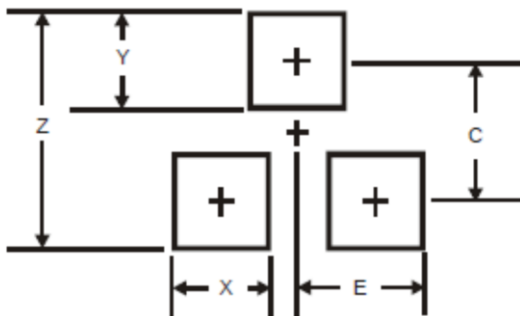

DIM.	Unit(mm)	Unit(inch)
	TYP	TYP
Z	2.8	0.11
X	0.7	0.03
Y	0.9	0.04
C	1.9	0.07
E	1.0	0.04

**PIN CONFIGURATION**

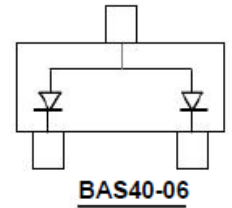
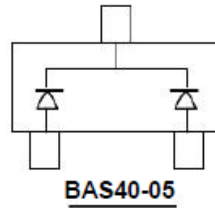
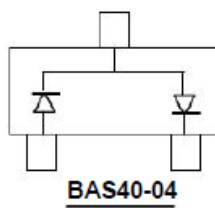
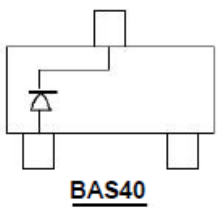

## Notice

Specifications of the products displayed herein are subject to change without notice. TSC or anyone on its behalf, assumes no responsibility or liability for any errors or inaccuracies.

Information contained herein is intended to provide a product description only. No license, express or implied, to any intellectual property rights is granted by this document. Except as provided in TSC's terms and conditions of sale for such products, TSC assumes no liability whatsoever, and disclaims any express or implied warranty, relating to sale and/or use of TSC products including liability or warranties relating to fitness for a particular purpose, merchantability, or infringement of any patent, copyright, or other intellectual property right.

The products shown herein are not designed for use in medical, life-saving, or life-sustaining applications. Customers using or selling these products for use in such applications do so at their own risk and agree to fully indemnify TSC for any damages resulting from such improper use or sale.