

User Manual

EC301

Potentiostat / Galvanostat

 **Stanford Research Systems**

Revision 1.1 (02/29/2016)

Certification

Stanford Research Systems certifies that this product met its published specifications at the time of shipment.

Warranty

This Stanford Research Systems product is warranted against defects in materials and workmanship for a period of one (1) year from the date of shipment.

Service

For warranty service or repair, this product must be returned to a Stanford Research Systems authorized service facility. Contact Stanford Research Systems or an authorized representative before returning this product for repair.

Information in this document is subject to change without notice.
Copyright © Stanford Research Systems, Inc., 2012—2016. All rights reserved.

Stanford Research Systems, Inc.
1290-D Reamwood Avenue
Sunnyvale, CA 94089 USA
Phone: (408) 744-9040 • Fax: (408) 744-9049
www.thinkSRS.com • e-mail: info@thinkSRS.com

Printed in U.S.A.

Document number 9-01712-903

Contents

1	General information	6
1.1	Safety and preparation for use	6
1.2	Unpacking	7
1.2.1	Standard equipment	7
1.2.2	Accessories	7
1.2.3	Optional equipment	7
1.3	Symbols you may find on SRS products	8
1.4	Specifications	9
1.5	Serial number and firmware revision	19
2	EC301 basics	20
2.1	Software	20
2.2	Functional block diagram	20
2.3	Polarity convention	22
2.4	Connecting the EC19 to the EC301	22
2.4.1	Necessary Items	22
2.4.2	Steps	23
3	Operation	24
3.1	Front panel	24
3.1.1	Power-on reset	24
3.1.2	Bandwidth limit	25
3.1.3	CE limit	25
3.1.4	Cell	25
3.1.5	External electrometer	26
3.1.6	Voltage	26
3.1.7	Current	26
3.1.8	Mode	27
3.1.9	Rotating electrode	27
3.1.10	Analog output	28
3.1.11	Current range	29
3.1.12	IR compensation	30
3.1.13	External input	31
3.1.14	Measurement setup/control	33
3.1.15	Knob	33
3.1.16	Configure	34
3.1.17	Remote status	35
3.2	Rear panel	36
3.2.1	Power entry	36
3.2.2	GPIB interface	36
3.2.3	Ethernet interface	37
3.2.4	Current interrupt synchronization	37
3.2.5	Timebase synchronization input	37
3.2.6	Scan trigger input	38
3.2.7	Program <i>E/I</i> output	40
3.2.8	Scan synchronization output	41
3.2.9	Auxiliary ADC inputs (1-3)	42
3.2.10	Resistance temperature detector (RTD) input	43
3.2.11	Grounding posts	44
3.2.12	Raw analog outputs	45
3.2.13	CE monitor	46
3.2.14	Synchronous ADC input	47

4	Making cell connections	48
4.1	Floating operation	49
4.1.1	Overview	49
4.1.2	Grounded Working Electrode	50
4.1.3	Grounded Counter Electrode	50
4.2	Working with grounded electrodes	51
5	Performing scans using the front panel	54
5.1	Setting scan parameters – potentiostat mode	54
5.1.1	Cyclic voltammetry (CV)	54
5.1.2	Linear sweep voltammetry (LSV)	56
5.1.3	Steps	58
5.1.4	Holds	60
5.2	Setting scan parameters – galvanostat mode	61
5.2.1	Cyclic current ramp	61
5.2.2	Linear current ramp	62
5.2.3	Current step	63
5.2.4	Current hold	64
5.3	Basic scan controls	65
5.4	Triggering scans	65
5.4.1	Triggering a scan from the front panel	65
5.4.2	Triggering a scan with the scan trigger input	65
5.4.3	Triggering a scan from the remote interface	65
5.5	Setting the end of scan condition	65
6	Using the EC301 with an external frequency response analyzer (FRA)	67
7	Boosted current operation	68
7.1	System installation	68
7.2	Ventilation and cooling	69
7.3	Entering boosted operation	70
7.4	Current interrupt under boosted operation	71
7.5	Bandwidth limitation under boosted operation	72
7.6	Returning to normal operation	72
7.7	Initial booster checkout	72
7.7.1	Open circuit test	72
7.7.2	Short circuit test	73
8	Remote programming	75
8.1	Command syntax	75
8.2	Argument formats	75
8.3	Detailed command list	76
8.3.1	Firmware and hardware revisions	76
8.3.2	Program E/I setup (with external input)	76
8.3.3	Control loop commands	79
8.3.4	Cell switch	81
8.3.5	IR compensation	82
8.3.6	Scan trigger commands	84
8.3.7	Rotating working electrode commands	85
8.3.8	Analog output commands	86
8.3.9	Voltage (E) measurement setup	88
8.3.10	Current (I) measurement setup	89
8.3.11	Reading single measurement results	91
8.3.12	Streaming data	93
8.3.13	Remote interface commands	97

8.3.14	Timebase commands	100
8.3.15	Status reporting commands	101
8.3.16	Pulsed waveform generation commands	111
8.3.17	Ramp generation commands	117
8.3.18	Arbitrary waveform generation commands	122
8.3.19	Reading temperature measurements	127
8.3.20	Booster operation commands	128
8.4	Programming examples	129
8.4.1	Normal pulse	129
8.4.2	Cyclic voltammetry	130
8.4.3	Current interrupt IR compensation	131
8.4.4	Arbitrary waveform	132
Bibliography		133
A Measuring cell voltages at the cell		134
B Pinouts		136
B.1	Cell interface (25 pins)	136
B.2	RTD interface (5 pins)	136
C Major symbols and abbreviations		138
Alphabetical command index		139

1 General information

1.1 Safety and preparation for use

Warning

Dangerous voltages, capable of causing injury or death, are present in this instrument. Use extreme caution whenever the instrument covers are removed. Do not remove the covers while the unit is plugged into a live outlet.

Line fuse

Verify that the correct line fuse(s) are installed before connecting the line cord. Fuse size is 3AB/3AG “slo-blo” ($\phi 6.3 \times 32$ mm). For 100 V/120 V, use a single 3 A fuse; for 220 V/240 V, use two 1.5 A fuses.

Line cord

The EC301 has a detachable, three-wire power cord for connection to the power source and to a protective ground. The exposed metal parts of the instrument are connected to the outlet ground to protect against electrical shock. Always use an outlet which has a properly connected protective ground.

Service

Do not attempt to service or adjust this instrument unless another person, capable of providing first aid or resuscitation, is present.

Do not install substitute parts or perform any unauthorized modification to this instrument. Contact the factory for instructions on how to return the instrument for authorized service and adjustment.

1.2 Unpacking

The following lists describe the standard and optional equipment supplied with the EC301. Open the box(es) and inspect all equipment and components, comparing the contents against your original order and the checklists below. Report any discrepancies, or any shipping damage, to Stanford Research Systems immediately.

1.2.1 Standard equipment

1. EC301 main unit
2. EC19
3. EC19 terminal cables (6 color coded)
4. Alligator clips (6)
5. Color coded boots for alligator clips (6)
6. Umbilical cable
7. Test board
8. RTD connector
9. This manual

Note: the *SRS*Lab software is included free of charge as a download from the SRS web site, www.thinkSRS.com.









1.2.2 Accessories

1. Replacement terminal cables / clips / boots (order O100CAB)
2. RTD probe (order O100RTD)
3. Rack mount kit (order O301RM)
4. Replacement manual (order M301)

1.2.3 Optional equipment

1. 5 Amp current booster (order O100BST)
2. 10 Amp current booster (order O200BST)
3. 20 Amp current booster (order O400BST)
4. Quartz crystal microbalance (order QCM200)

1.3 Symbols you may find on SRS products

Symbol	Description
	Alternating current
	Caution - risk of electric shock
	Frame or chassis terminal
	Caution - refer to accompanying documents
	Earth (ground) terminal
	Battery
	Fuse
	On (supply)
	Off (supply)

1.4 Specifications

Voltage and current measurement accuracy

- Voltage measurement accuracy
 $\pm 0.2\%$ of reading ($V_{RE} - V_{WE\ SENSE}$) $\pm 5\text{mV}$
- Current measurement accuracy, 1 A range
 $\pm 0.5\%$ of reading (I_{WE}) $\pm 0.2\%$ of range
- Current measurement accuracy, other ranges
 $\pm 0.2\%$ of reading (I_{WE}) $\pm 0.2\%$ of range
- Power amplifier
 - Compliance voltage
 $\geq \pm 30\text{V}$ full compliance
 - Maximum output current
 $\geq \pm 1\text{A}$
 - Slew rate (power amplifier in isolation)
 $\geq 10\text{V}/\mu\text{s}$
 - Output short-circuit protected

Boosted operation

Option	O100BST	O200BST	O400BST	units
Maximum DC Current	±5	±10	±20	Amps
Max. system compliance voltage	±20			V
Applied potential accuracy	0.5% of reading ±5 mV			
Current measurement accuracy	1% of reading ±3 mA			
Current measurement rise time(1)	45 (at ±2.5 V)	40 (at ±5 V)	40 (at ±10 V)	μs
Potentiostatic analog bandwidth (2)	10			kHz
Applied voltage risetime (1)	45 (at ±2.5 V)	40 (at ±5 V)	35 (at ±10 V)	μs
Applied current accuracy	0.5% of reading ±3 mA			
Measured potential accuracy	0.2% of reading ±5 mV			
Galvanostatic analog bandwidth (3)	3	3	1.25	kHz
Applied current risetime (1)	50 (at ±2.5 V)	100 (at ±5 V)	200(at ±10 V)	μs

Notes

- (1) 10% – 90%, 1 kHz square wave, 0.5 Ω load, at specified amplitude.
- (2) –3 dB, 1 Vrms, 1 Ω load.
- (3) –3 dB, 1 Amp rms, 0.5 Ω load.

Potentiostat mode

- Applied potential accuracy:

Potential versus reference within	Accuracy
$\pm 5\text{V}$	$\pm 0.2\%$ of setting $\pm 5\text{mV}$
$\pm 10\text{V}$	$\pm 0.5\%$ of setting $\pm 5\text{mV}$
$\pm 15\text{V}$	$\pm 1\%$ of setting $\pm 5\text{mV}$

- Applied potential resolution:

Mode	Resolution
General (potential set with thumbwheel or remote interface)	$500\mu\text{V}$
Performing an automatic scan (CV or LSV)	$200\mu\text{V}$

- Noise and ripple

$< 20\mu\text{V}_{\text{rms}}$ (1Hz \rightarrow 10kHz)

- Applied E range

$\pm 15\text{V}$ versus reference ($|\text{CE}| < 30\text{V}$ versus signal ground)

Galvanostat mode

- Applied current accuracy:
 - $\pm 0.5\%$ of setting $\pm 0.2\%$ of current range, 1 A range
 - $\pm 0.2\%$ of setting $\pm 0.2\%$ of current range, all other ranges

ZRA mode

- Voltage offset
 - CE **sense** and WE **sense** electrodes held within 5 mV of each other
- Output current
 - 1 A range: -1 A min, $+1$ A max
 - All other ranges: $-2\times$ full scale min, $+2\times$ full scale max

General control loop

- Bandwidth control

Bandwidth limits

10Hz, 100Hz, 1kHz, 10kHz, 100kHz, >1MHz
(10k Ω resistive load, < 100 μ A output current)

- Compliance limiting

Voltage limit accuracy

Cell current (I_{CE})	Accuracy
$\leq 10\text{mA}$	$\pm 250\text{mV}$
$\leq 1\text{A}$	$\pm 1\text{V}$

IR compensation

- Current interrupt

Switching time (on \rightarrow off) $< 5\mu\text{s}$ (1 k Ω resistive load)

Interrupt time

100 μs \rightarrow 1s

Interrupt frequency

0.1 Hz \rightarrow 300 Hz

- Positive feedback

Range

I_{range}	R_{u}
boosted (5 A, 10 A, 20 A)	0 \rightarrow 0.3 Ω
1 A	0 \rightarrow 3 Ω
100 mA	0 \rightarrow 30 Ω
10 mA	0 \rightarrow 300 Ω
1 mA	0 \rightarrow 3 k Ω
100 μA	0 \rightarrow 30 k Ω
10 μA	0 \rightarrow 300 k Ω
1 μA	0 \rightarrow 3 M Ω
100 nA	0 \rightarrow 30 M Ω
10 nA	0 \rightarrow 300 M Ω
1 nA	0 \rightarrow 3 G Ω

Resolution

1 m Ω for 1A range1 M Ω for 1nA range

General system

- Remote interfaces
 - LAN (10/100 base-T Ethernet)
 - GPIB (IEEE-488)
- Dimensions (W × H × D)
 - Main box
 - 17 × 18.5 × 5.25 inches
 - External box
 - 3.25 × 4.75 × 2.5 inches
 - Umbilical
 - 36 inches
 - Weight
 - Power
- RTD measurement
 - Temperature sensor
 - User supplied 100Ω Pt RTD, $\alpha = 0.00385 \Omega/\Omega/^\circ\text{C}$
 - Range
 - −100°C to +200°C
 - Resistance measurement accuracy
 - ±0.3Ω

Front panel connectors

- External input
 - $\pm 15\text{V}$ analog input in potentiostat mode, $\pm 2\text{V}$ in galvanostat mode
 - Input impedance: $10\text{k}\Omega \parallel 50\text{pF}$
- Rotating electrode output BNC
 - $0 \rightarrow 10\text{V}$ analog output
 - Accuracy: $\pm 1\%$ of setting $\pm 5\text{mV}$
 - Output impedance: 10Ω
 - 10mA max output current
- Voltage (E) output BNC
 - $\pm 15\text{V}$ analog output
 - Accuracy: $\pm 0.2\%$ of $V_{\text{RE}} - V_{\text{WE Sense}} \pm 5\text{mV}$
 - Output impedance: 50Ω
 - 10mA max output current
- Current (I) output BNC
 - $\pm 2\text{V}$ analog input
 - Accuracy: I_{WE} within $\pm 0.5\%$ of $(V_{\text{BNC}} \times I_{\text{range}}) \pm 0.2\% \times I_{\text{range}}$, 1A range
 - Accuracy: I_{WE} within $\pm 0.2\%$ of $(V_{\text{BNC}} \times I_{\text{range}}) \pm 0.2\% \times I_{\text{range}}$, other ranges
 - Output impedance: 50Ω
 - 10mA max output current

Rear panel connectors

- Timebase input BNC
 - Frequency: 10MHz
 - Level: 1Vpp (nominal)
- TTL measurement synchronization BNCs
 - Current interrupt and scan synchronization outputs, scan trigger input
- Program E/I output BNC
 - ±15V analog output
 - Accuracy: ±0.2% of total program voltage (internal sources + external input) ± 5 mV
 - Output impedance: 10Ω
 - 10mA max output current
- Auxiliary ADC input BNCs
 - Three ±10V analog to digital inputs
 - input impedance: 100kΩ
 - 1mV resolution
- Signal / floating ground banana jacks
 - Signal ground ohmically connected to chassis ground
 - Floating ground can float ±8 V relative to signal ground
 - Signal/floating ground isolation: 10 MΩ
- RTD input
 - 5-pin connector for Pt RTD temperature probe
- Booster interface
 - 9-pin connector to support optional boosted operation
- Raw E output BNC
 - ±15V analog output
 - Accuracy: ±0.2% of $V_{RE} - V_{WE\ SENSE} \pm 5\text{mV}$
 - Output impedance: 50Ω
 - 10mA max output current
- Raw I output BNC
 - ±2V analog input
 - Accuracy: I_{WE} within ±0.5% of $(V_{BNC} \times I_{range}) \pm 0.2\% \times I_{range}$, 1 A range
 - Accuracy: I_{WE} within ±0.2% of $(V_{BNC} \times I_{range}) \pm 0.2\% \times I_{range}$, other ranges
 - Output impedance: 50Ω
 - 10mA max output current
- CE/3 output BNC
 - ±10V analog output
 - Accuracy: ±1% of $V_{CE/3} \pm 10\text{mV}$
 - Output impedance: 50Ω
 - 10mA max output current

- Synchronous ADC input
 - Sampled synchronously with E and I ADCs
 - $\pm 10\text{V}$ analog to digital input
 - input impedance: $100\text{k}\Omega$
 - 16-bit resolution
- Ethernet interface
- IEEE 488 interface
- Chassis ground
- Power entry module

Differential electrometer

- Input impedance
> $1\text{T}\Omega \parallel 20\text{pF}$
- Input bias current
< 20pA
- Common-mode rejection ratio (CMRR)

Bandwidth	CMRR (dB)
10 kHz	80 (90 typ.)
100 kHz	60 (70 typ.)

- Bandwidth
> 10MHz

Cell current input (WE)

- Ranges
10 decades – 1A to 1nA
Boosted operation: $\pm 5\text{A}$, $\pm 10\text{A}$, $\pm 20\text{A}$

1.5 Serial number and firmware revision

- Serial number

If you need to contact Stanford Research Systems, please have the serial number of your unit available. The 5-digit serial number is printed on a label affixed to the rear panel. The unit is powered on. The serial number can also be displayed on the front panel after the unit is powered on by pressing the [DISPLAY] key.

- Firmware revision

The firmware revision code is shown on the front panel when the unit is powered on.

2 EC301 basics

2.1 Software

The EC301 is intended to operate with the *SRS Lab* Windows software package. *SRS Lab* can be downloaded from the SRS web site, www.thinkSRS.com. Complete instructions for *SRS Lab*, in the form of documentation videos, are also available on the website.

2.2 Functional block diagram

Figure 1 illustrates the major signal paths in the EC301.

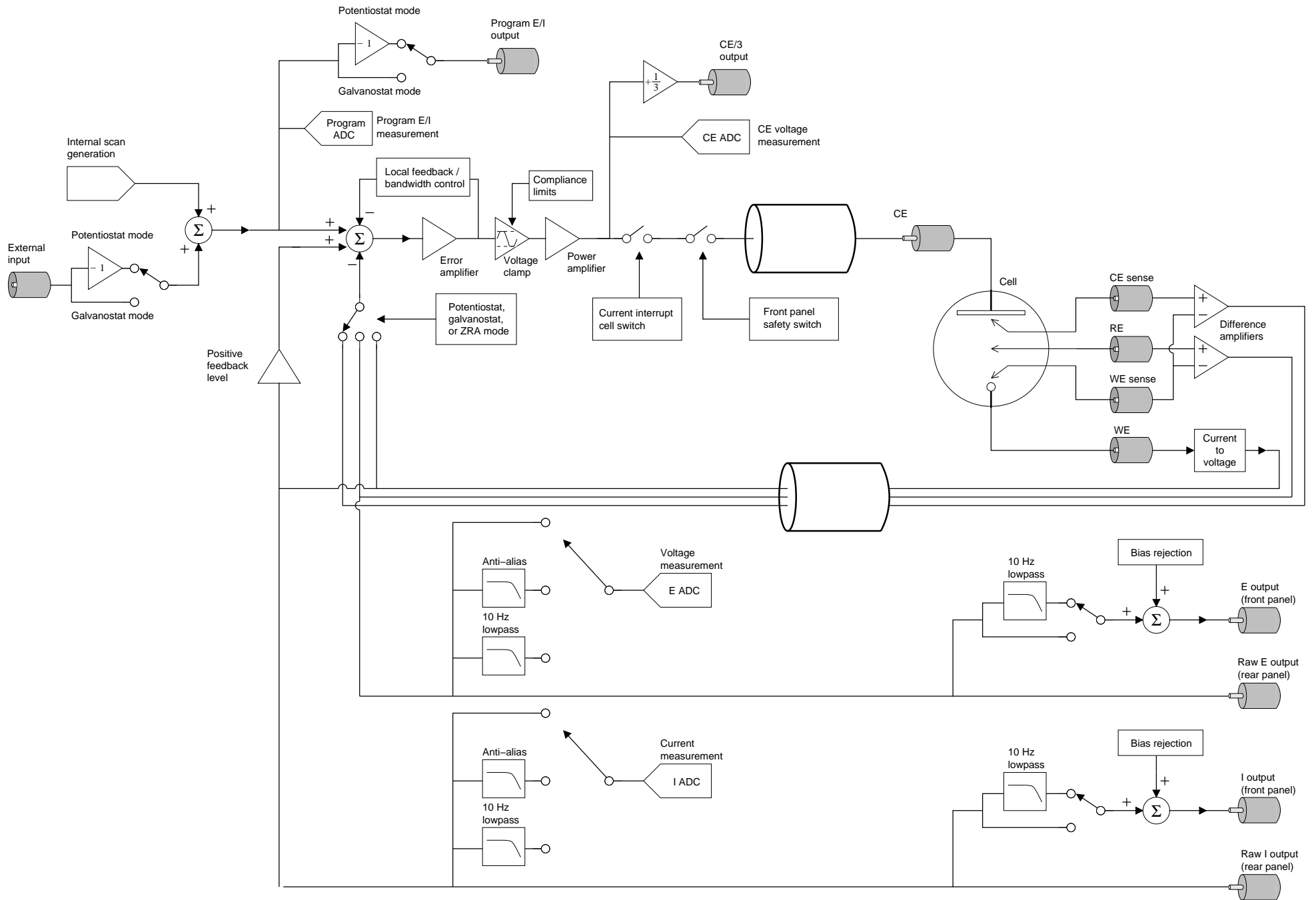

Figure 1: EC301 block diagram.

2.3 Polarity convention

The relative polarity of voltages and currents handled by the EC301 follows the American polarity convention. As illustrated in Fig. 2, this convention calls for cathodic (reducing) currents to be taken as positive. Voltages are programmed taking RE as the reference potential, so asking for +1V with the external input or the front panel will move the WE potential +1V above RE. We invert the polarity of the front and rear panel **VOLTAGE** outputs relative to the front panel display in order to accommodate frequency response analyzers (FRAs).

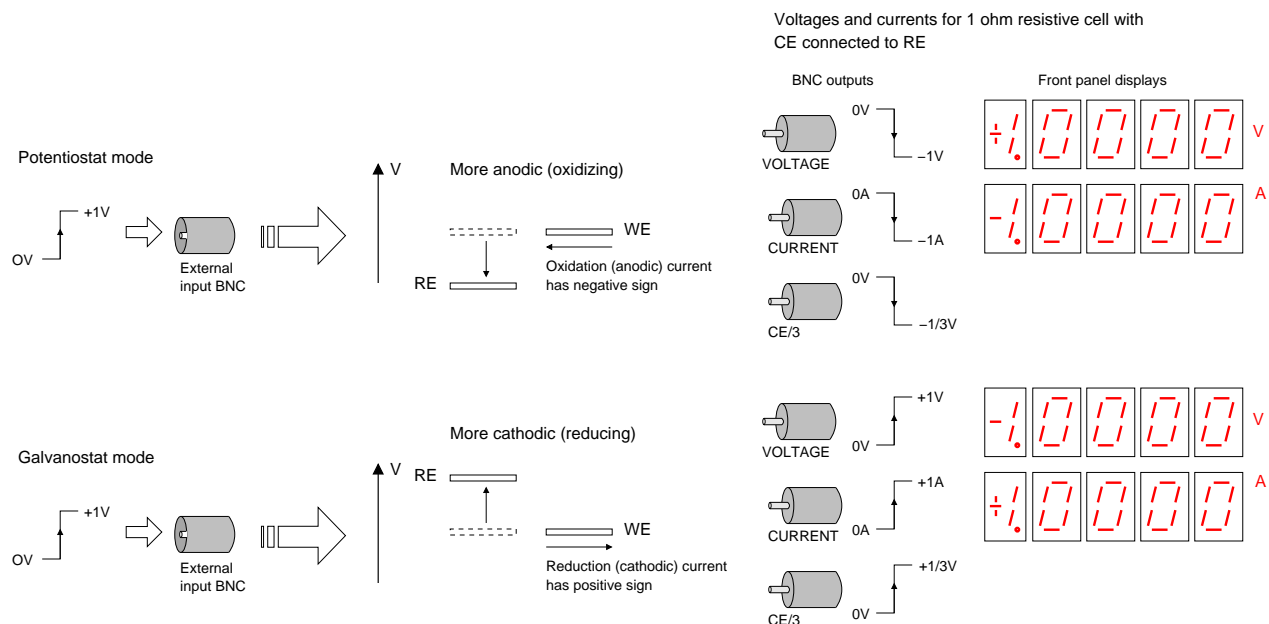

Figure 2: The EC301 uses the American polarity convention when applying voltages and currents.

2.4 Connecting the EC19 to the EC301

Before you do any electrochemical measurements with the EC301, you must first connect the EC19.

2.4.1 Necessary Items

In order to connect an EC19 to an EC301, you will need a flat blade screwdriver, and the umbilical cable. All items except the flat bladed screwdriver were provided in your EC301 shipment. Each item is pictured in Fig. 3.



Figure 3: From left to right: EC19, umbilical cable, EC301, flat blade screwdriver.

2.4.2 Steps

1. Identify the connection points on the EC19. There are two jack screws on the rear panel of the unit, shown in Fig. 4.

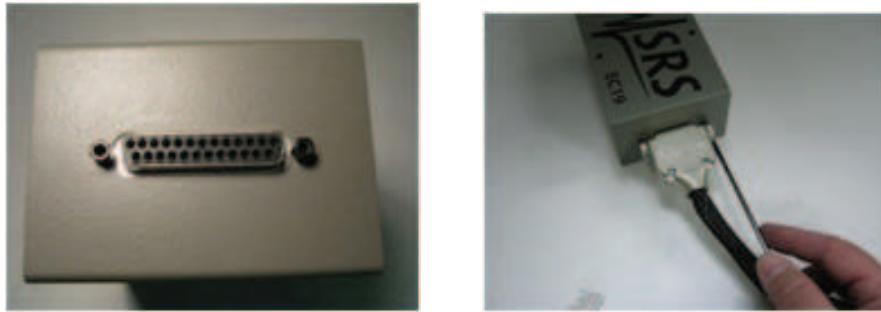

Figure 4: EC19 rear panel connector. Securing the umbilical cable.

2. Screw the umbilical cable screws into the jack screws of the EC19 as shown in Fig. 4.
3. Identify the connection points on the EC301. There are two jack screws on the front panel of the unit, shown in Fig. 5.



Figure 5: Front panel umbilical connector on EC301. Securing the umbilical cable to the EC301.

4. Screw the umbilical cable screws into the jack screws of the EC301 as shown in Fig. 5.
5. Power up the EC301 (switch is on rear panel). If you get any front panel errors about the EC19, turn off the EC301. Check the umbilical connection on both ends and power up the EC301 again. If errors persist, contact SRS.

3 Operation

This manual will refer to a key with brackets such as [Key].

3.1 Front panel

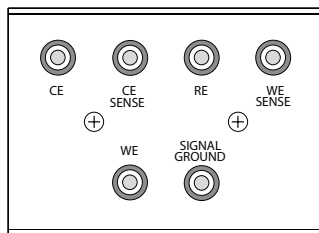
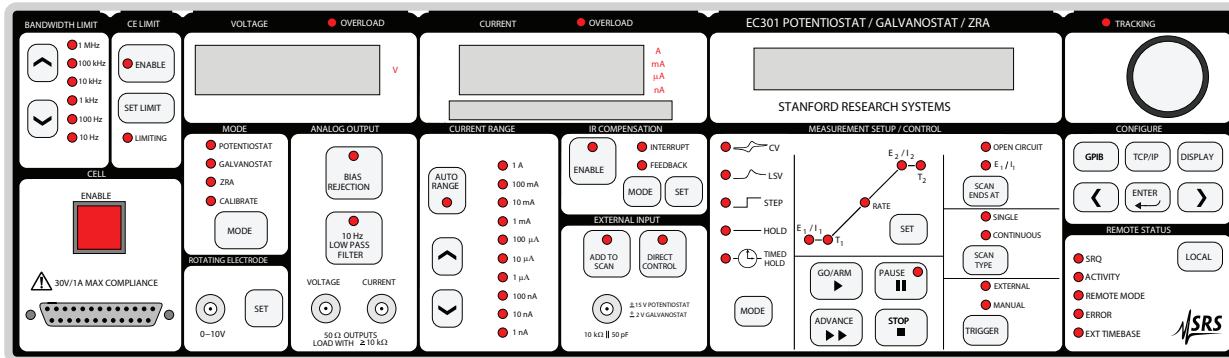

3.1.1 Power-on reset

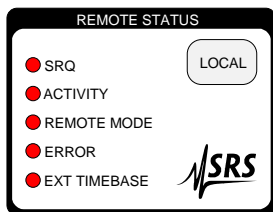

To restore the instrument to its factory-default settings from the front panel, hold down the [LOCAL] key while the power is turned on.

3.1.2 Bandwidth limit

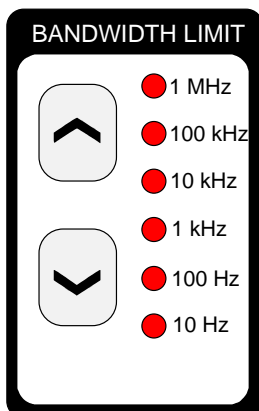

Use the [^] and [v] keys to increase or decrease the control bandwidth.

3.1.3 CE limit

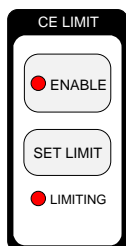

The counter electrode (CE) voltage relative to ground can be limited to protect sensitive cells. Using the [ENABLE] key to enter the limiting mode allows reducing the maximum CE voltage from $\pm 500\text{mV}$ to $\pm 30\text{ V}$. This maximum is adjusted by pressing the [SET LIMIT] key and turning the knob. The tracking light will indicate that the CE limit follows the knob movement.

3.1.4 Cell

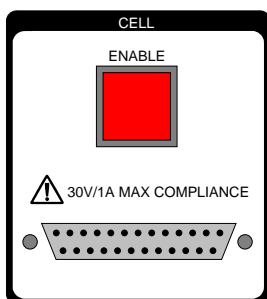

The external electrometer should be connected to the main box using this DB-25 connector. The umbilical should be securely fastened to this connector using the jack screws on either side.

Use the [ENABLE] switch to manually disconnect the CE from the power amplifier whenever you must come in contact with the cell electrodes. This switch is illuminated when the CE is connected to the control circuitry. When this switch is “in,” the instrument connects or disconnects the CE as needed. When “out,” the CE is always disconnected and the switch is dark.

3.1.5 External electrometer

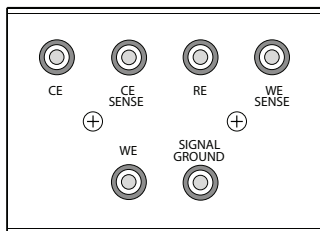

The external electrometer face contains the counter electrode (CE) output, three electrometer inputs, the working electrode (WE) current input, and a grounded binding post. See section 4 for illustrations of how these inputs and outputs are used in different instrument modes.

CE (counter electrode) output: This is the output of the EC301's control amplifier. It can source or sink 1A into a -30V to +30V range.

CE SENSE input: This electrometer input is used with WE SENSE in ZRA mode to monitor the voltage between two typically identical electrodes. As shown in figure 12, it is named for usually being connected to the CE output.

RE (reference electrode) input: As illustrated in figure 1, this electrometer input is used with WE SENSE to monitor cell potentials.

WE SENSE input: As illustrated in figure 1, this electrometer input is used with both the RE and CE SENSE electrodes to monitor cell potentials.

WE input: This input connects to a shunt resistor used to measure current flowing in the working electrode. The input resistance here will vary with the current range setting.

SIGNAL GROUND: This can be connected to a Faraday cage to isolate sensitive cells from electrical noise.

3.1.6 Voltage

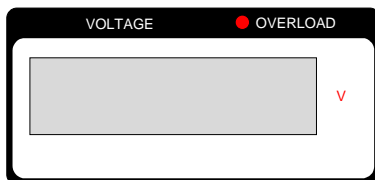

This display shows the results of the internal $V_{WE\ SENSE} - V_{RE}$ measurement. The OVERLOAD light indicates when the cell potential exceeds ± 15 V relative to signal ground. Measurement accuracy will degrade from specifications outside of this range.

Under boosted operation, the display functions the same way. No scaling of the reported reading is necessary.

3.1.7 Current

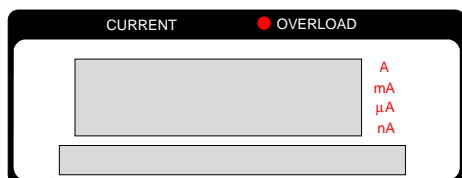

This display shows the results of the internal cell current measurement. The OVERLOAD light indicates when current exceeds $\pm 2 \times I_{range}$ or 1A, where I_{range} is the current range in use. Measurement accuracy will degrade from specifications during overloads.

Under boosted operation, the display functions the same way. No scaling of the reported reading is necessary.

3.1.8 Mode

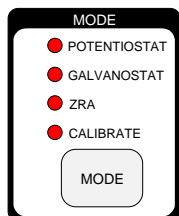

Use the [MODE] key to cycle the EC301 through its various operating modes.

POTENTIOSTAT: control potential and measure current. In this mode, the EC301 controls the potential of the working relative to the reference electrode. The counter electrode is driven to whatever potential is necessary (within the ± 30 V or the user-imposed compliance limits) to hold $V_{WE\ SENSE} - V_{RE}$ at the control (program) voltage.

GALVANOSTAT: control current and measure potential. In this mode, the EC301 controls cell current flowing through the working electrode. The counter electrode is driven to whatever potential is necessary to hold this current at the programmed value.

ZRA (Zero-resistance ammeter): hold two electrodes at the same potential. In this mode, the EC301 holds the counter and working electrodes at the same potential while current flows between them. Current flow with no potential drop implies no resistance – hence the name of the mode. The relative potential is sensed with the WE SENSE and CE SENSE connections, and the counter electrode is driven to hold this potential at zero.

CALIBRATE: This function is reserved for use by the factory.

3.1.9 Rotating electrode

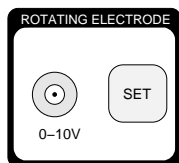

This DC voltage output can be used with an external control unit to control the speed of rotating working electrodes. Use the [SET] key to adjust the output voltage within $0 \rightarrow 10$ V.



This output can source a maximum of 10 mA. The input impedance of the external control unit must be larger than 1 k Ω to achieve the maximum 10 V output.

3.1.10 Analog output

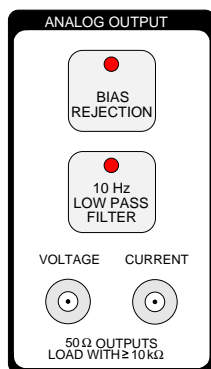

This section contains the VOLTAGE and CURRENT analog outputs as well as the [BIAS REJECTION] and [10 Hz LOWPASS FILTER] controls for modifying the outputs.

VOLTAGE output (E_{BNC}): This output is the potential of the reference electrode with respect to the working electrode, optionally subjected to a 10 Hz lowpass filter and/or bias rejection. The ± 15 V output range is the same as the maximum polarization range.

CURRENT output (I_{BNC}): This output is proportional to current flowing in the working electrode (I_{WE}), optionally subjected to a 10 Hz lowpass filter and/or bias rejection. The output voltage is given by

$$I_{\text{BNC}} = 1\text{V} \times \frac{I_{\text{WE}}}{I_{\text{range}}}$$

where I_{range} is the current range in use (1 mA, 10 mA, etc.). As described in section 2.3, I_{BNC} becomes more positive when current flows into the working electrode (cathodic current).



The polarity at the VOLTAGE BNC output (E_{BNC}) is opposite that reported on the front panel displays. The voltage is thus $E_{\text{BNC}} = V_{\text{RE}} - V_{\text{WE SENSE}}$. We invert the polarity here to correct the sign of the cell impedance Z_{cell} calculated with

$$Z_{\text{cell}} = \frac{E_{\text{BNC}}}{I_{\text{range}} \times I_{\text{BNC}}}$$

where I_{range} is the current range in use and I_{BNC} is the voltage at the CURRENT BNC output. See figure 2 for an illustration of BNC versus display polarities.

[BIAS REJECTION]: Bias rejection attempts to subtract off the DC component of the analog output voltages. This can be useful when making AC response measurements in the presence of a DC hold. Removing the DC component of a signal can allow the use of more sensitive input ranges on external equipment like frequency response analyzers.

When [BIAS REJECTION] is pushed, the EC301 will immediately average $V_{\text{RE}} - V_{\text{WE SENSE}}$ and I_{WE} over a 1s window. It will then subtract those average values from all subsequent front panel E_{BNC} and I_{BNC} outputs. The averages will not update until bias rejection is turned off and then back on. Note that the RAW E and RAW I outputs on the rear panel always provide the $V_{\text{RE}} - V_{\text{WE SENSE}}$ and I_{WE} measurements with no filtering or bias rejection.



Bias rejection affects both analog outputs simultaneously when engaged from the front panel, but can be limited to either output when set up using the remote interface. The individual rejection levels can also be set arbitrarily instead of being automatically detected. See section 8.3.8 on page 86 for the appropriate remote commands.



Neither changing the current range nor enabling autoranging is allowed while bias rejection is active.

[10 Hz LOW PASS FILTER]: Use this key to simultaneously filter both the VOLTAGE and CURRENT analog outputs. The front panel filter has a 6 dB/octave rolloff with a -3 dB frequency of 10 Hz.



You can customize filter settings using the `lpfile` and `lpfile` commands described in section 8.3.8. These commands allow filtering a single output instead of both. Note that the [10 Hz LOW PASS FILTER] key will light whenever filtering is applied to either output.

3.1.11 Current range

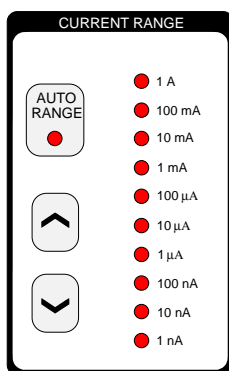

Use the [^] and [v] keys to select a current range. A cell current (I_{WE}) equal to the selected current range ($I_{WE} = I_{range}$) gives 1 V at the CURRENT output BNC ($I_{BNC} = 1 V$). Likewise, 1 V applied to the EXTERNAL INPUT BNC in galvanostat mode will generate a controlled current of I_{range} .

Currents exceeding $\pm 2 \times I_{range}$ or $\pm 1 A$ will generate an overload condition. While the EC301 can accept currents $\leq \pm 1 A$ in any range without damage, measurement accuracy is degraded during overloads.

Use the [AUTO RANGE] key to toggle automatic selection of I_{range} based on the measured cell current. Note that auto-ranging is not allowed in galvanostat mode.

During boosted operation, all I_{range} LEDs are off, indicating that the booster is performing the current measurement. Auto-ranging is not allowed under boosted operation.

3.1.12 IR compensation

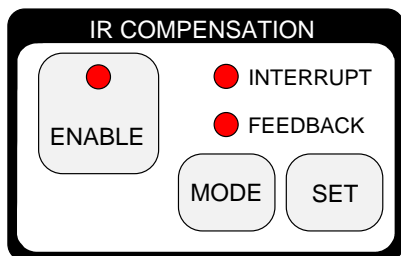

IR compensation involves adding an “extra” voltage to the control (program) voltage to compensate for drops between RE and WE. Use the [MODE] key to toggle between two ways of generating this voltage: positive feedback and current interrupt. Compensation will not be applied until the [ENABLE] key is pressed.

INTERRUPT mode: Figure 6 illustrates the parameters used for current interrupt when engaged from the front panel. In this mode, the CE is periodically disconnected from the control electronics to interrupt the cell current. This removes any IR drop between the reference and working electrodes, causing $|V_{WE\ SENSE} - V_{RE}|$ to

drop by ΔV_{ir} . The EC301 then takes two samples of $|V_{WE\ SENSE} - V_{RE}|$ to measure this drop – one after interruption, and one after control is restored. This value, along with the percent correction factor, is used to calculate the boost potential ΔV_b added to the program voltage.

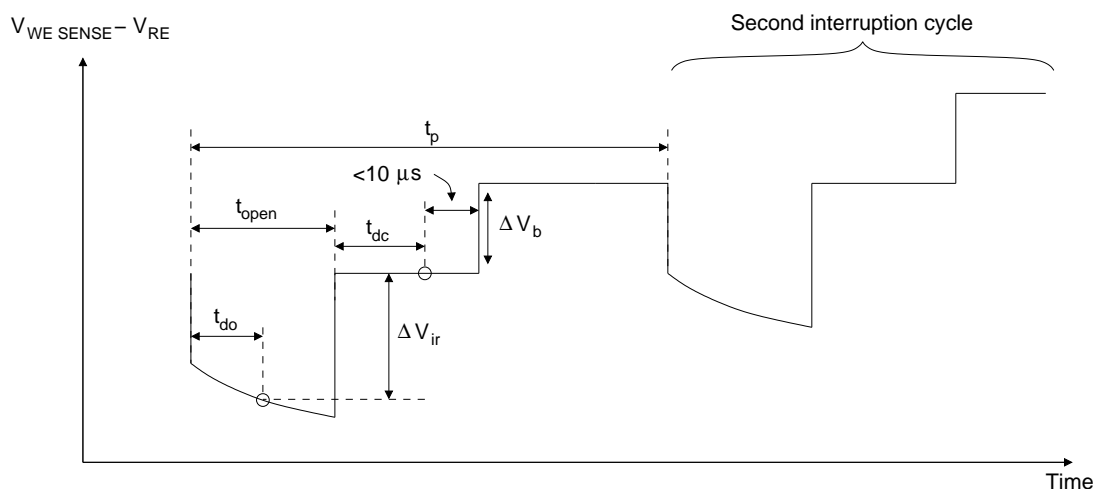

Figure 6: Cell potentials during current interrupt IR compensation. Default values for the various parameters are shown in table 1.

Use the [SET] key in INTERRUPT mode to adjust the percent correction factor – the only parameter than can be set from the front panel. The other parameters shown in figure 6 are set to the default values shown in table 1.

Parameter	Default value	Remote command
t_p	100 ms (10 Hz)	<code>ciperd</code> (see page 83)
t_{open}	200 μs	<code>ciopen</code> (see page 82)
t_{do}	120 μs	<code>cidlay</code> (see page 83)
t_{dc}	200 μs	

Table 1: Default values for current interrupt parameters. These values are used when current interrupt is engaged using the front panel.

Current interrupt performance is significantly reduced under boosted operation. See chapter 7 for details.



The current interrupt parameters can be adjusted away from their default values using the remote interface. See section 8.4.3 on page 131 for an example.

FEEDBACK mode: Positive feedback IR compensation adds a boost voltage $I_{WE} \times R_u$ to the program voltage, where R_u is the uncompensated resistance parameter.

Use the [SET] key in **FEEDBACK** mode to adjust R_u . The allowed ranges for R_u in each current range are shown in table 2.

Note that current interrupt performance is derated under booster operation. See section 7.4 for details.

I_{range}	R_u
1 A	0 → 3 Ω
100 mA	0 → 30 Ω
10 mA	0 → 300 Ω
1 mA	0 → 3 kΩ
100 μA	0 → 30 kΩ
10 μA	0 → 300 kΩ
1 μA	0 → 3 MΩ
100 nA	0 → 30 MΩ
10 nA	0 → 300 MΩ
1 nA	0 → 3 GΩ

Table 2: Allowed R_u ranges for each current range.

3.1.13 External input

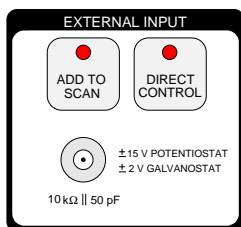

The EC301 can take its control voltage directly from the external analog input, allowing its use with function generators and frequency response analyzers. These control voltages can be used by themselves or added to internally-generated scans.

In potentiostat mode, voltages applied at the external input will be applied to the cell according to the American Polarity Convention described in section 2.3. This input has unity gain: +1 V applied at the input will change ($V_{WE\ SENSE} - V_{RE}$) by +1 V. The input thus accepts the full ±15 V allowed polarization range.

In galvanostat mode, controlled current is given by

$$I_{WE} = I_{range} \left(\frac{V_{ext} + V_{prog}}{1V} \right)$$

where V_{ext} is the voltage applied at the external input and V_{prog} is the internally-generated program voltage. Currents greater than $2 \times I_{range}$ or 1 A will generate overloads, so the external input's range in this mode is ±2 V for $I_{range} < 1$ A, and ±1 V for $I_{range} = 1$ A. The polarity is again taken from the American Polarity Convention described in section 2.3.

Use the [ADD TO SCAN] key to toggle adding the external input voltage to internally-generated scans or holds. This key leaves engaging the control loop (lighting the **CELL** button) up to the scan controls.

Use the [DIRECT CONTROL] key if potentials or currents to be applied to the cell come only from the external input. If the cell is enabled (via the **CELL** button), [DIRECT CONTROL] engages or disengages the control loop, taking control voltages or currents solely from the external input.

The external input is ignored (taken as 0 V) if both the [ADD TO SCAN] and [DIRECT CONTROL] lights are dark.

3.1.14 Measurement setup/control

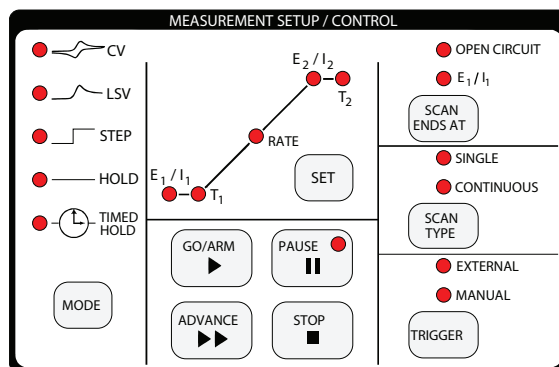

A variety of automatic scans and holds can be programmed from the EC301's front panel. Once the scan type is selected, you will be prompted for a set of necessary parameters. When [GO/ARM] is pressed with a MANUAL trigger setting, the EC301 will engage control, apply the scan, and remove control as required by the scan end condition.

Use the [MODE] key to select a scan type. These types are described in section 5 on page 54.

Use the [TRIGGER] key to select the action of [GO/ARM]. In MANUAL mode, the programmed scan will begin when [GO/ARM] is pressed. In EXTERNAL mode, pressing [GO/ARM] will “arm” the EC301 – preparing it to scan with the next rising or falling edge received at the rear panel SCAN TRIGGER input. This allows the scan to be triggered by other experimental events. See section 3.2.6 on page 38 for more information about the SCAN TRIGGER input.

3.1.15 Knob

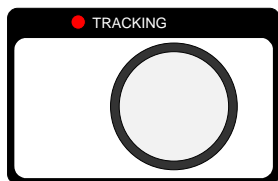

Use the knob to enter numbers via the character display. The knob is velocity-sensitive, so experiment with different rotation speeds to set large numbers.

The TRACKING indicator will light when turning the knob will immediately affect cell conditions. For example, if a hold has been engaged from the front panel (control loop is engaged – big red CELL button is lit) and the [SET] key is pressed to adjust E_1/I_1 , TRACKING will light to indicate that cell polarization is moving with

the knob. This allows manually adjusting polarization while observing other cell characteristics – “thumb-wheel scanning.”

Most parameters can be “locked in” by re-pushing the same key used to set them. For example, pushing [SET] once to adjust the E_1 of a hold will allow E_1 to be freely changed with the knob. Pushing [SET] again will lock the value in and disable the knob. The value will also be locked in if a [SET] key from another section is pressed. In general, moving on to another setting will lock the previous one.

3.1.16 Configure

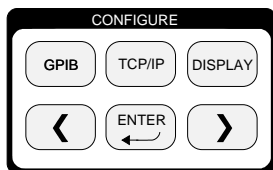

Use this section to configure the remote interface (LAN, GPIB) and to cycle through the various display modes.

3.1.17 Remote status

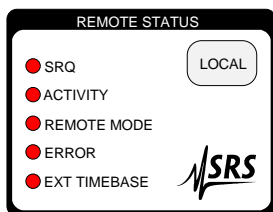

The indicators in this section describe the status of the remote (GPIB or LAN) interface and the external timebase.

SRQ: This indicator is on whenever a service request (SRQ) is generated by the EC301. It will stay on until the status register (INSR, MESR, or *ESR) causing the SRQ is cleared. See figure 34 on page 110 for a description of how status bit values are promoted to cause SRQs.

ACTIVITY: This indicator flashes when there is activity on the remote interface.

REMOTE MODE: This indicator is on when the front panel is locked out by the remote interface. No front panel adjustments may be made until the [LOCAL] key is pressed.

ERROR: This indicator flashes when there is a remote interface error such as an illegal command or an out of range parameter.

EXT TIMEBASE: The EC301 can accept an external 10 MHz timing signal to improve the accuracy and stability of automatic scans. This indicator will light when such a timing signal is detected.

[LOCAL]: The remote command LOCKFP can lock out the front panel keyboard. Use the [LOCAL] key to exit this mode and enable the front panel keys.

3.2 Rear panel

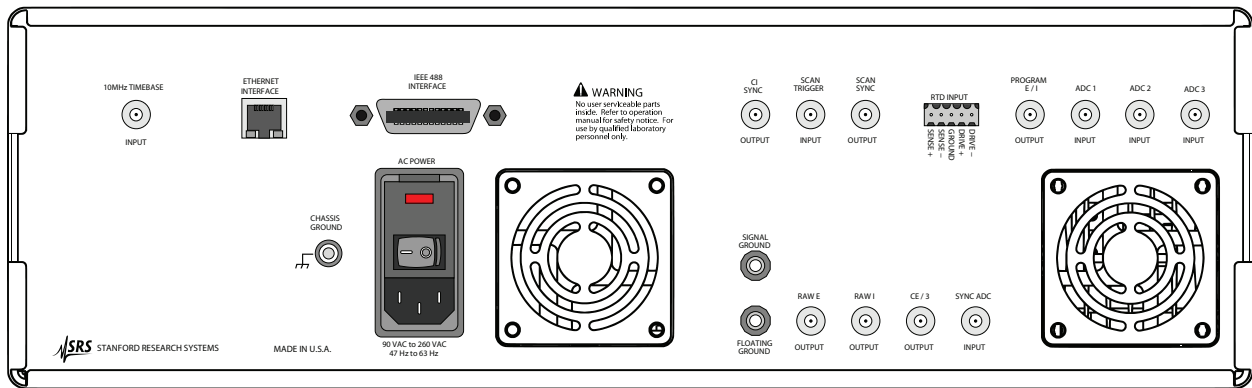

3.2.1 Power entry



The power entry module is used to fuse the AC line voltage input and to block high frequency noise from entering or exiting the instrument.

3.2.2 GPIB interface

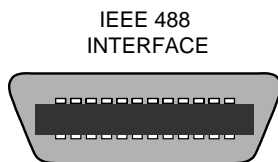

The 24 pin GPIB connector allows a computer to control the EC301 via the GPIB (IEEE-488) instrument bus. The GPIB address is set with the front panel [GPIB] key.

3.2.3 Ethernet interface

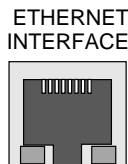

There are two LEDs on the RJ-45 ethernet connector. The green LED lights only when the system is transmitting. The yellow LED lights whenever it sees any packet on the wire. This includes packets not destined for the EC301.

3.2.4 Current interrupt synchronization

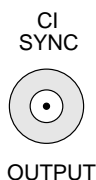

This digital output allows triggering an oscilloscope or other data acquisition at the beginning of current interruption. This output will be brought low just before interruption begins and returned high after it ends. The timing diagram is shown in figure 7.

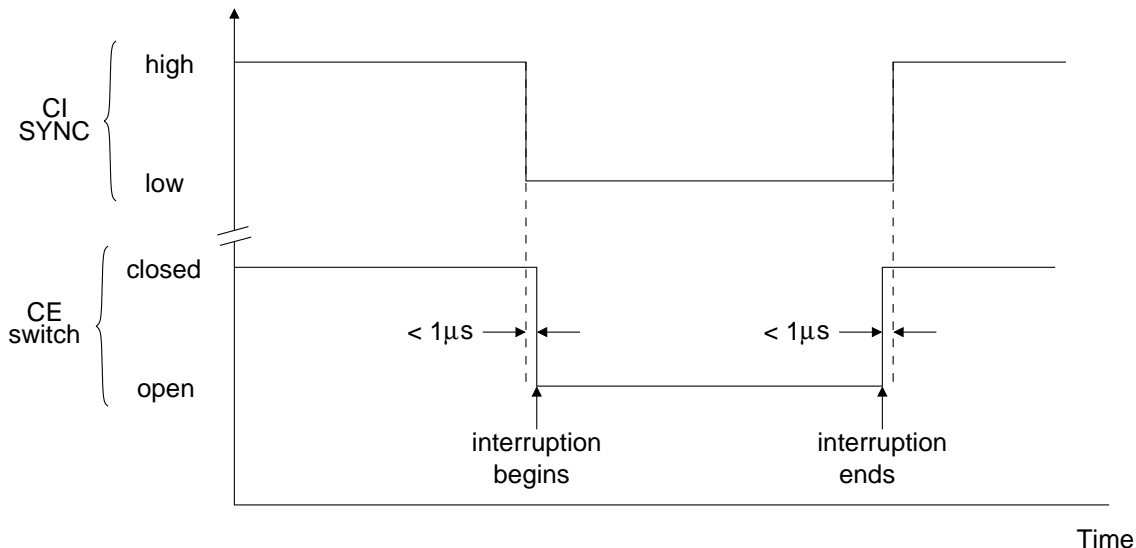
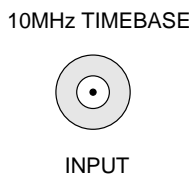

Figure 7: Timing diagram for the CI SYNC digital output.

3.2.5 Timebase synchronization input

This BNC can accept a 10 MHz reference signal from an external source to improve the stability of the internal clock. The external source should be greater than 1V peak-to-peak and should be within ± 2 ppm of 10 MHz.



3.2.6 Scan trigger input

This input allows starting an automatic scan with external equipment. As illustrated in figure 8, an falling edge here will begin the scan within $1\mu\text{s}$.

The EC301 must be “armed” from the front panel or the remote interface to use this input. See section 3.1.14 on page 33 to set this condition from the front panel. See the `trgarm` command described on page 84 to arm with the remote interface.

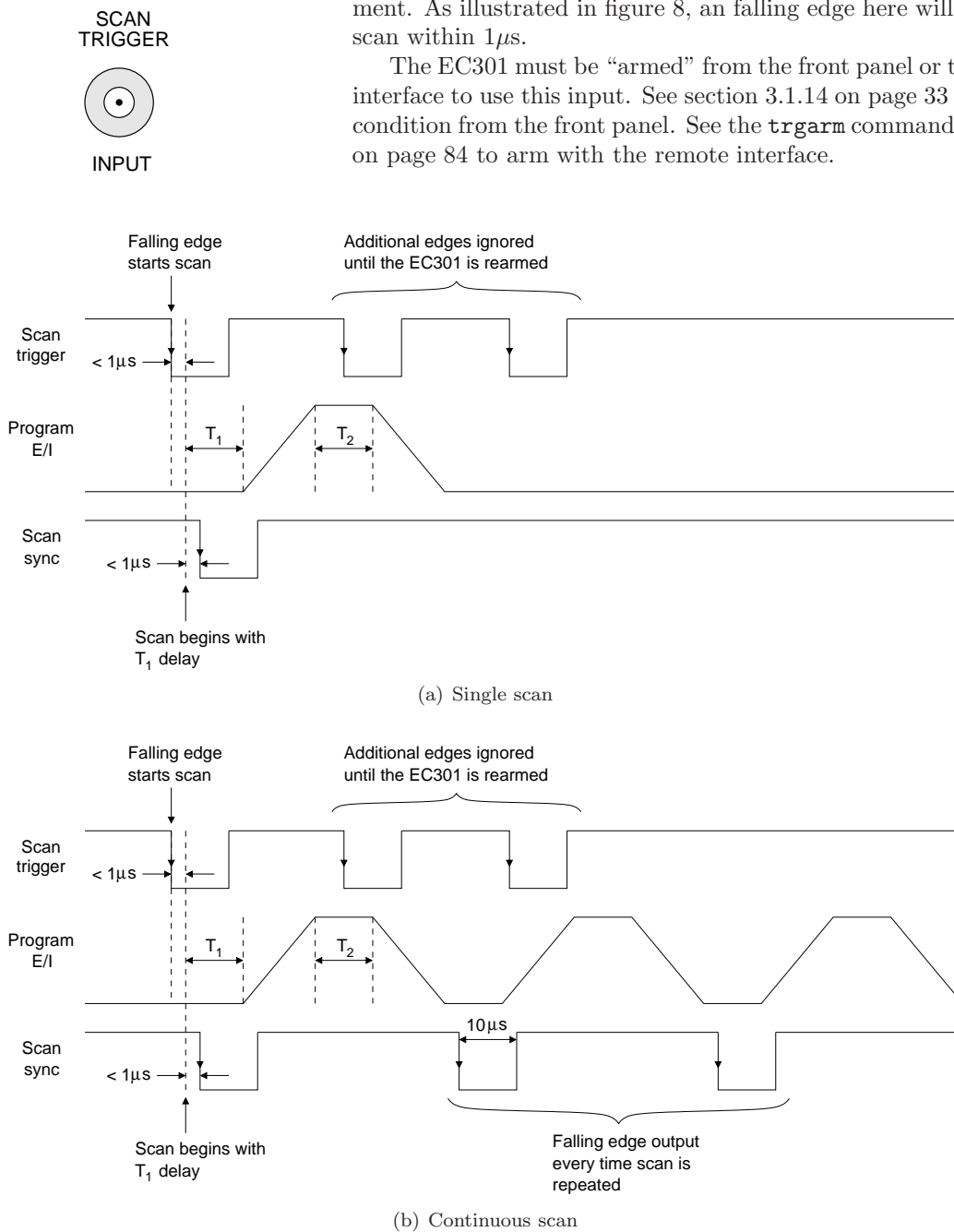

Figure 8: Timing diagrams for the SCAN TRIGGER input and the SCAN SYNC output using falling edge trigger polarity.



Why do these scans have flat “tops?” Figure 8 illustrates both CV and LSV scans triggered by the rear panel scan trigger input. Since the **OPEN CIRCUIT** end condition isn’t allowed for this trigger mode, LSV scans must track back to their initial state after T_2 – making them look like CV scans with flat tops. The two scans would look identical for $T_2 = 0$.

3.2.7 Program E/I output

PROGRAM
E/I



OUTPUT

This output is a copy of the input to the EC301's control circuitry. As illustrated in figure 1, it is the sum of the external input and the internal scan voltages.

When used with current interrupt IR compensation, this output provides the "corrected" potential applied to the working electrode. It can be used to plot IR-compensated data on xy plotters and displays.



This output will reflect the input to the EC301's control circuitry even when the control loop is open. For example, starting a +1V hold from the front panel (without any external input voltage) will move PROGRAM E/I to -1V. Stopping the hold won't change this output - it will remain at -1V until a new scan is configured and run. Note that the polarity for this output is consistent with the front-panel VOLTAGE output described in section 2.3 on page 22.

3.2.8 Scan synchronization output

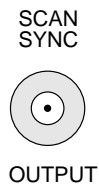

This output allows triggering an oscilloscope or synchronizing other data acquisition using with the start of a scan. As illustrated in figure 9, this output is brought low immediately before the scan begins and before every scan repetition during continuous scans. The output is held low for $10\ \mu\text{s}$ before returning high, which limits the rate to roughly 50 kHz. The EC301 can not reliably send trigger pulses for repetition rates faster than this.

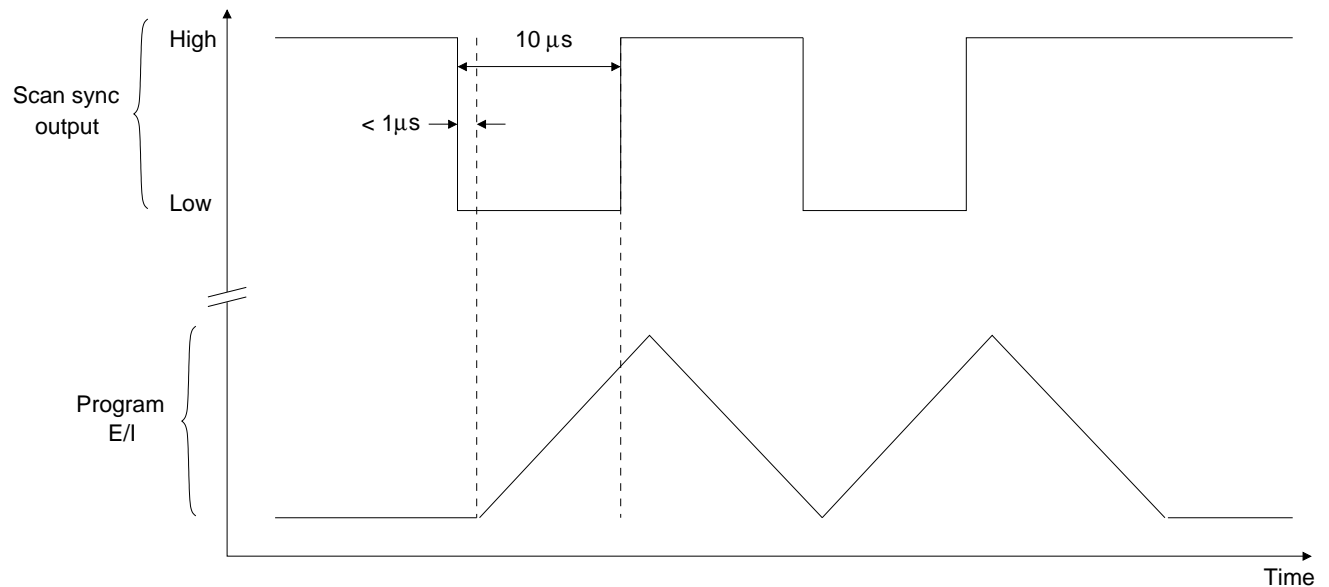
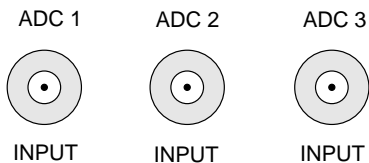

Figure 9: The SCAN SYNC output is brought low at the beginning of a scan and held there for $10\ \mu\text{s}$.

3.2.9 Auxiliary ADC inputs (1-3)



These ± 10 V inputs allow monitoring analog signals like flow rate, pH, or temperature along with E and I data. Using the remote interface, data from these inputs can be synchronized with E and I collection to within 1 ms. Use the synchronous ADC input described in section 3.2.14 on page 47 for tighter timing requirements.



Use the `getaux?` command described on page 91 to acquire data from these BNCs using the remote interface

3.2.10 Resistance temperature detector (RTD) input

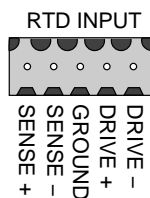

The EC301 can accept standard 100Ω Pt RTD probes for logging experimental temperatures. The probe temperature is determined with a 4-wire measurement of the probe resistance. As illustrated in figure 10, commercial 4-wire RTDs normally have two wires of the same color connected to one end of the resistive sensor, and two wires of a different color connected to the opposite end. One of each pair carries the drive current used in the measurement, and the other is used to sense the voltage induced by this current. The “drive” and “sense” leads are interchangeable.

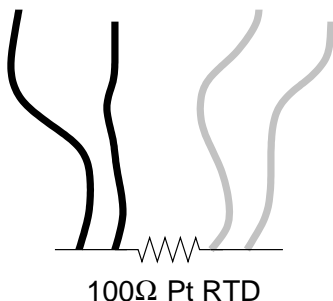

Figure 10: Commercial 4-wire RTD probes have two wires with the same color attached to each end.

These 4-wire sensors are connected to the EC301 in one of two electrically-identical ways illustrated in figure 11. Notice that the signs of the DRIVE and SENSE inputs match for the same color of wire. Any other wire configuration will give no temperature reading when the probe is connected.

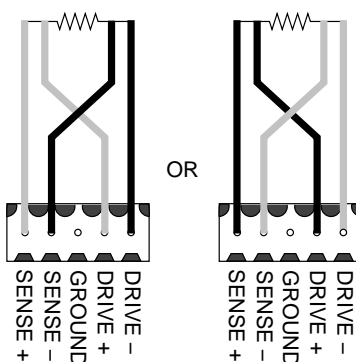

Figure 11: 4-wire probes can be connected to the EC301 in one of these two ways.

RTD sensor wires are connected to the RTD input using 5-pin Weidmuller plugs (Weidmuller part number 169045). These plugs use a tension clamp to hold the wires in place. To install the wires:

1. Hold the plug in front of you with the five small holes on top and the five larger holes on the bottom.
2. In each hole is a metal clip. Place a small screwdriver into one of the small holes and firmly push it in to the small gap above the clip. The screwdriver should go in about half an inch. The thickness of the screwdriver shaft pushes the clip down toward the larger hole.
3. The larger hole should open up. Place a stripped wire into the hole and remove the screwdriver.

3.2.11 Grounding posts

SIGNAL
GROUND



FLOATING
GROUND

These grounding posts should be connected together unless the cell's working electrode is intrinsically grounded. Disconnecting these isolates the CE-to-WE current path from earth ground, allowing measurements with grounded working electrodes. See section 4.2 for more information on this situation.

3.2.12 Raw analog outputs

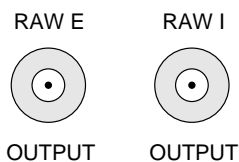

These outputs carry the same signals as their counterparts on the front panel, but without any bias rejection or filtering. See section 3.1.10 for a better description of the E and I output voltages. The same polarity convention applies to both the front and rear panel outputs.

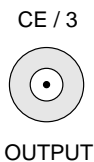

The output resistance of these sources is 50Ω – the same as for those on the front panel. The input resistance of whatever these outputs are connected to should exceed $10\text{k}\Omega$ to keep loading errors below 1%.

3.2.13 CE monitor

This output provides the counter electrode (CE) voltage relative to floating ground divided by 3. If signal and floating grounds are connected together, this output will span ± 10 V as the CE spans ± 30 V. As with the raw E and I outputs, this signal is not affected by bias rejection or filter settings.



The output resistance of this source is 50Ω . The input resistance of whatever this is connected to should exceed $10\text{k}\Omega$ to keep loading errors below 1%.

3.2.14 Synchronous ADC input

SYNC ADC



INPUT

This ± 10 V analog input allows sampling external signals simultaneously with the E and I measurements. The EC301 has separate ADCs devoted to the E , I , and synchronous ADC measurements. All three ADCs share the same sample control signal to ensure simultaneous measurements.

4 Making cell connections

Figures 12a, b, and c illustrate how the EC301 should be used with cell configurations in potentiostat and galvanostat modes. Figure 12d illustrates typical cell connections during an experiment using ZRA mode.

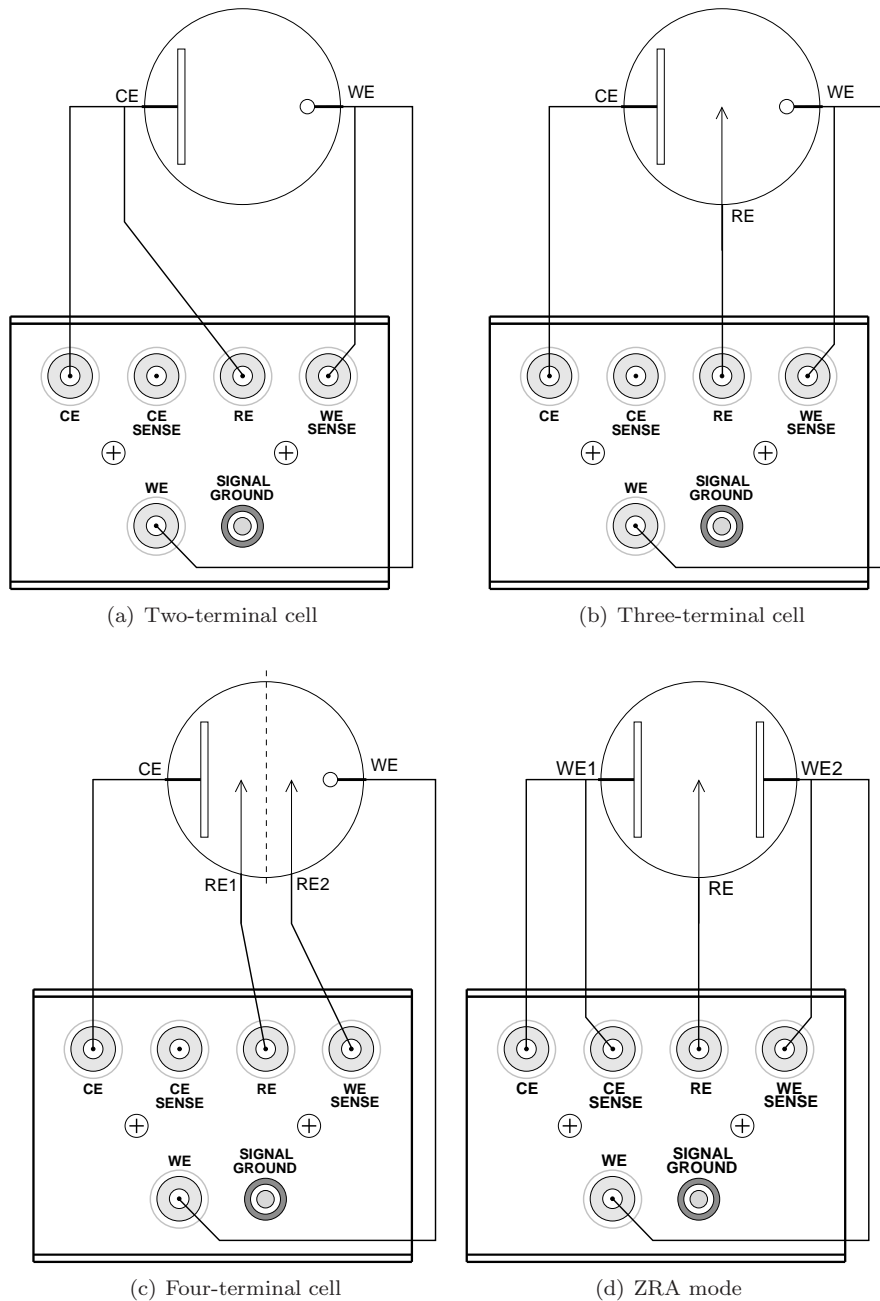

Figure 12: Making cell connections



Probing electrode voltages with a standard oscilloscope probe can cause problems with grounding and noise. See appendix A for more details.

4.1 Floating operation

The EC301 was designed with floating operation in mind. Users may operate on a Working Electrode (WE) that is intrinsically grounded, or they may wish to strap the Counter Electrode (CE) to earth ground for safety reasons. The EC301 will accommodate those measurements, but there are some configuration adjustments that must be made.

4.1.1 Overview

For floating operation, remove the factory-installed shorting bar that ties the “signal ground” and the “floating ground” together (see Fig. 13). Pull the bar away from the instrument to remove it.



Figure 13: EC301 grounding bar (installed).

The signal ground is an internal reference which is maintained at close to chassis ground potential. The floating ground is a separate reference that is free to reach a potential difference up to ± 8 volts from signal ground. In the event the potential between signal and floating grounds exceeds this limit, the instrument

will not be damaged. In this case, the CE limit will be activated and the potential across the cell will not be well-controlled.

The EC301 grounding scheme leaves all the connectors on the chassis unaffected by floating operation. Instruments such as oscilloscopes and frequency response analyzers often tie other instruments' chassis to earth ground once a BNC cable is attached between them. This is permissible even when the EC301 is floating, because the BNC shells are tied to chassis ground and not floating ground. This enables EIS (electrochemical impedance spectroscopy) even on working electrodes that must float.

Floating operation necessitates some trade-offs in performance. The EC301 specifications only apply when the signal and floating grounds are connected on the rear panel by the supplied shorting bar (i.e. when the instrument is *not* floating).

4.1.2 Grounded Working Electrode

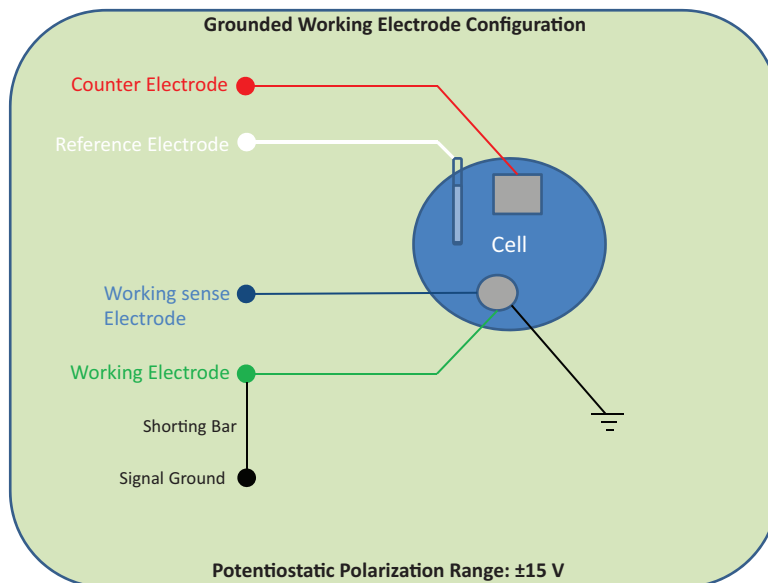

Figure 14: Grounded working electrode configuration.

Once you have removed the shorting bar from the rear panel of the instrument (see Overview, above), install it between the two banana jacks on the EC19 labeled “WE” and “SIGNAL GROUND” (see Fig. 15). The shorting bar provides a low impedance path between the intrinsic ground at the cell and the EC301 internal reference ground, improving noise performance and adding stability to the current meter.

Make the rest of the connections from the EC19 to the cell as normal. Under these conditions, the full $\pm 15\text{ V}$ potentiostatic polarization range is available.

4.1.3 Grounded Counter Electrode

Once you have removed the shorting bar from the rear panel of the instrument (see Overview, above), you are ready to begin measurements in this configuration. You may achieve somewhat improved noise performance by attaching a jumper between CE and signal ground.

When you tie the CE to Earth ground, be aware that the full potentiostatic polarization range is not available. In this configuration, the potentiostatic set point dictates the potential between signal and floating ground. The maximum polarization range under these conditions is $\pm 8\text{ V}$.



Figure 15: Grounding WE at the EC19.

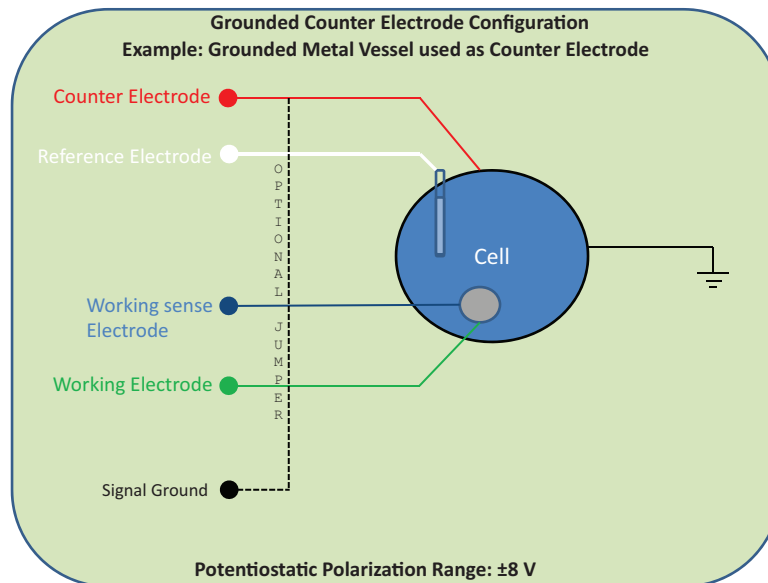

Figure 16: Grounded counter electrode configuration.

4.2 Working with grounded electrodes

Grounded electrodes are those inextricably connected to earth ground. Figure 17 illustrates cathodic protection of a buried pipeline, in which the counter and working electrodes are necessarily buried in and thus connected to earth. Figure 18a illustrates the proper current circuit in this situation: out of the power amplifier, through the CE and WE electrodes, through the WE shunt resistor, and back to the power amplifier

through floating ground. If, however, the floating and signal ground binding posts described in section 3.2.11 are left connected, current can bypass the WE entirely. Figure 18b shows current flowing out of the CE and being returned to the power amplifier through earth ground, which has a low-resistance connection to signal ground. The rear panel signal and floating grounds should thus be disconnected when making measurements with grounded electrodes.

The rear panel ground banana jacks should only be disconnected when necessary. Reconnect them when using isolated cells to improve frequency response.

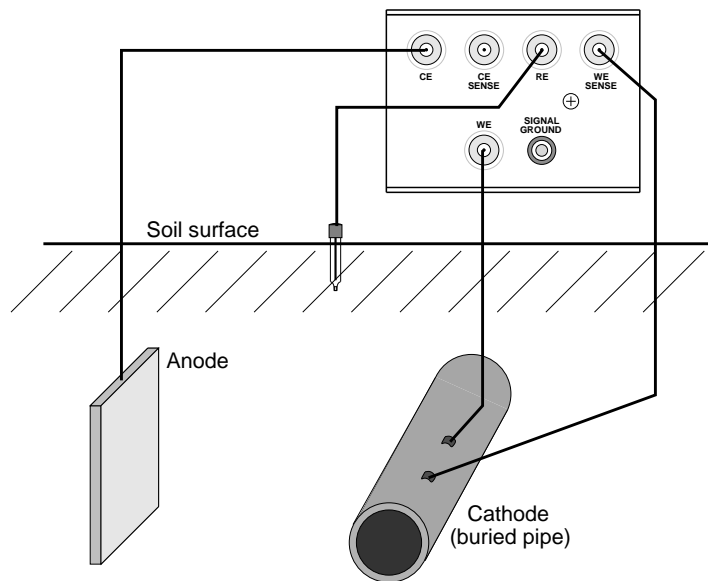
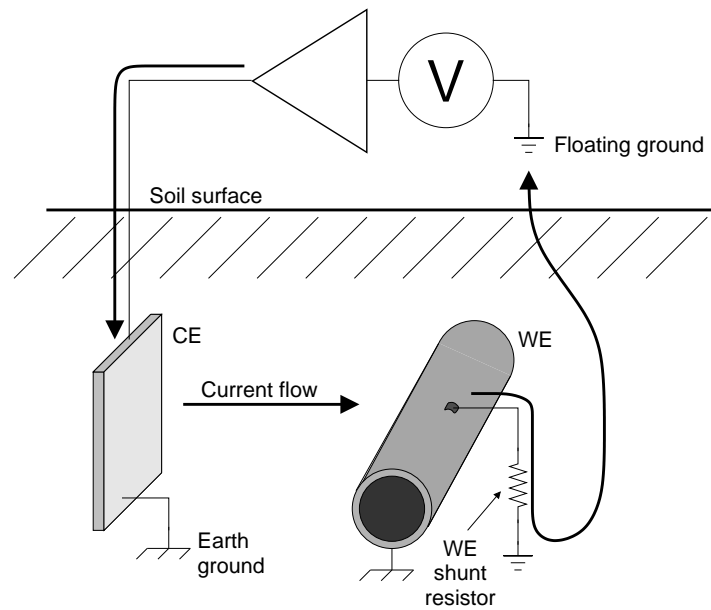
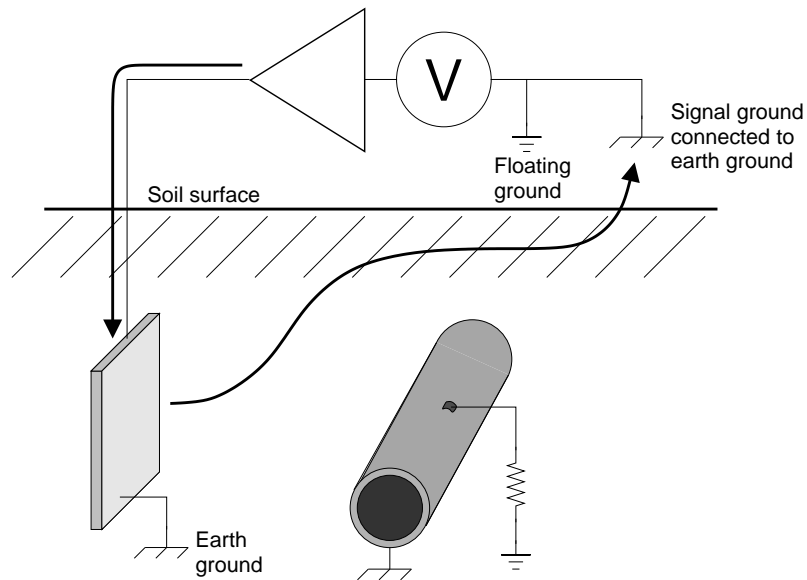

Figure 17: Buried and inextricably grounded electrodes used in cathodic protection.



(a) Proper current flow with floating and signal ground posts disconnected



(b) One of many undesired current flow paths with floating and signal ground posts connected

Figure 18: Disconnecting the signal and floating ground terminals on the EC301 allows current to flow in circuits including earth ground.

5 Performing scans using the front panel

5.1 Setting scan parameters – potentiostat mode

5.1.1 Cyclic voltammetry (CV)

Figure 19 illustrates the parameters needed to specify a CV scan. The procedure is as follows:

1. Use the [MODE] key to select CV.
2. Cycle through the required parameters using [SET], adjusting values using the knob. Times are adjusted using the knob for individual fields, and the arrow keys described in section 3.1.16 on page 34 to move between the fields shown below.

$$\underbrace{00}_{\text{hours}} : \underbrace{00}_{\text{minutes}} : \underbrace{00}_{\text{seconds}} : \underbrace{0000}_{\text{seconds}/10^4}$$

The maximum hold time for a CV is 99:59:59.9999 (100 μ s short of 100 hours). The setability is in 100 μ s steps.

3. Choose the scan end condition. Figure 19(a) illustrates the cell potential for the E_1 end condition, while 19(b) shows it for OPEN CIRCUIT.
4. Choose SINGLE or CONTINUOUS scanning. Single scans, illustrated in figures 19(a) and (b), go to the end scan condition after reaching E_1 on the return ramp. Continuous scans, illustrated in figure 19(c), immediately turn around to repeat the forward ramp and then the entire triangle-shaped waveform.
5. Choose the trigger mode. MANUAL allows the [GO/ARM] key to trigger the scan, while EXTERNAL mode requires the rear panel scan trigger input. See section 5.4 on page 65 for a better description of scan triggers in general, and section 3.2.6 on page 38 for a description of the rear panel scan trigger.

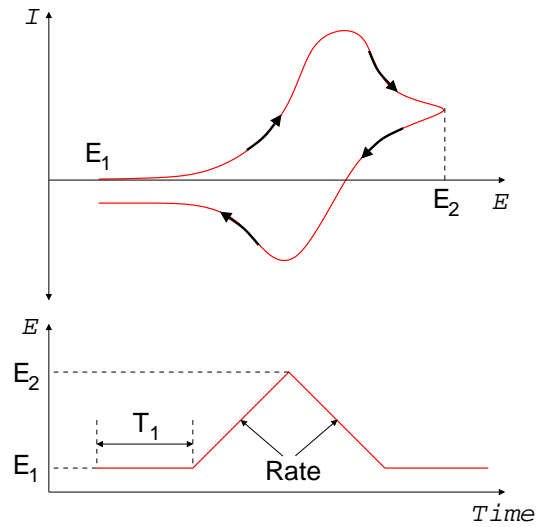

(a) A CV program and typical I vs. E plot using SINGLE scan type and E_1 end condition.

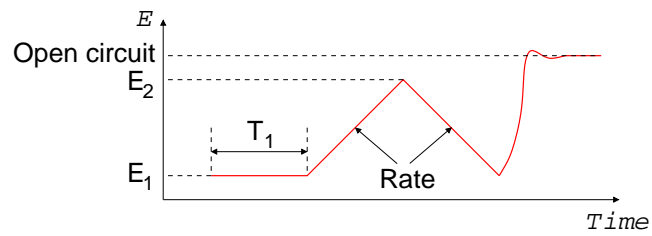

(b) A CV program followed by a simulated jump to open circuit using SINGLE scan type and OPEN CIRCUIT end condition. The cell potential is uncontrolled when the return ramp finishes.

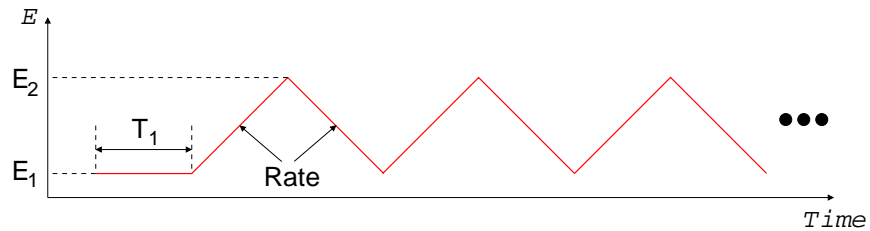

(c) A CV program using CONTINUOUS scan type. The triangle-shaped program continues indefinitely.

Figure 19: Parameters used to set up a cyclic voltammogram (CV).

5.1.2 Linear sweep voltammetry (LSV)

Figure 20 illustrates the parameters needed to specify a LSV scan. The procedure is as follows:

1. Use the [MODE] key to select LSV.
2. Cycle through the required parameters using [SET], adjusting values using the knob. Times are adjusted using the knob for individual fields, and the arrow keys described in section 3.1.16 on page 34 to move between the fields shown below.

$$\underbrace{00}_{\text{hours}} : \underbrace{00}_{\text{minutes}} : \underbrace{00}_{\text{seconds}} : \underbrace{0000}_{\text{seconds}/10^4}$$

The maximum hold time for a LSV is 99:59:59.9999 (100 μ s short of 100 hours). The setability is in 100 μ s steps.

3. Choose the scan end condition. Figure 20(a) illustrates the cell potential for the E_1 end condition, while 20(b) shows it for OPEN CIRCUIT. If the end condition is OPEN CIRCUIT, the cell potential will be free to drift after the T_2 wait time. If the condition is E_1 , the potential will immediately return to E_1 .
4. Choose SINGLE or CONTINUOUS scanning. Single scans, illustrated in figures 20(a) and (b), go to the end scan condition after the T_2 wait time. Continuous scans, illustrated in figure 20(c), track back to E_1 after the T_2 wait time with the same rate used for the forward ramp. They then repeat the entire program indefinitely.
5. Choose the trigger mode. MANUAL allows the [GO/ARM] key to trigger the scan, while EXTERNAL mode requires the rear panel scan trigger input. See section 5.4 on page 65 for a better description of scan triggers in general, and section 3.2.6 on page 38 for a description of the rear panel scan trigger.

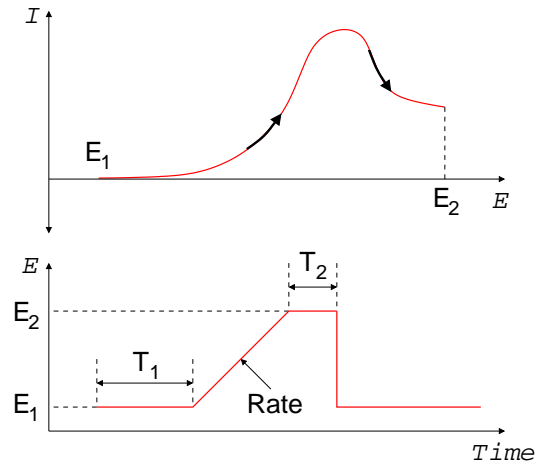

(a) A LSV program and typical I vs. E plot using SINGLE scan type and E_1 end condition.

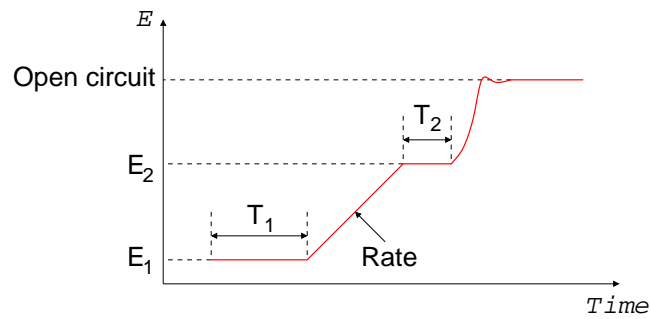

(b) A LSV program followed by a simulated jump to open circuit using SINGLE scan type and OPEN CIRCUIT end condition. The cell potential is uncontrolled when the T_2 wait time finishes.

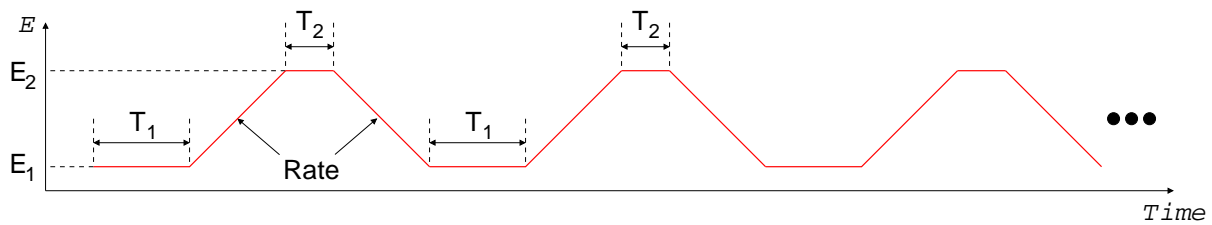

(c) A LSV program using CONTINUOUS scan type. The trapezoid-shaped program continues indefinitely.

Figure 20: Parameters used to set up a linear sweep voltammogram (LSV).

5.1.3 Steps

Figure 21 illustrates the parameters needed to specify a step scan. The procedure is as follows:

1. Use the [MODE] key to select **STEP**.
2. Cycle through the required parameters using [SET], adjusting values using the knob. Times are adjusted using the knob for individual fields, and the arrow keys described in section 3.1.16 on page 34 to move between the fields shown below. Note that the setability is in $4\mu\text{s}$ steps.

$$\underbrace{00}_{\text{minutes}} : \underbrace{00}_{\text{seconds}} : \underbrace{000}_{\text{milliseconds}} : \underbrace{000}_{\mu\text{seconds}}$$

The maximum delay time is 01:07.108860 ($2^{24} - 1$ counts $\times 4\mu\text{s}/\text{count}$).

3. Setability is $4\mu\text{s}$.
4. Choose the scan end condition. Figure 21(a) illustrates the cell potential for the E_1 end condition, while 21(b) shows it for **OPEN CIRCUIT**. If the end condition is **OPEN CIRCUIT**, the cell potential will be free to drift after the T_2 wait time. If the condition is E_1 , the potential will immediately return to E_1 .
5. Choose **SINGLE** or **CONTINUOUS** scanning. Single scans, illustrated in figures 21(a) and (b), go to the end scan condition after the T_2 wait time. Continuous scans, illustrated in figure 21(c), step back to E_1 after the T_2 wait time and repeat the entire step program indefinitely.
6. Choose the trigger mode. **MANUAL** allows the [GO/ARM] key to trigger the scan, while **EXTERNAL** mode requires the rear panel scan trigger input. See section 5.4 on page 65 for a better description of scan triggers in general, and section 3.2.6 on page 38 for a description of the rear panel scan trigger.

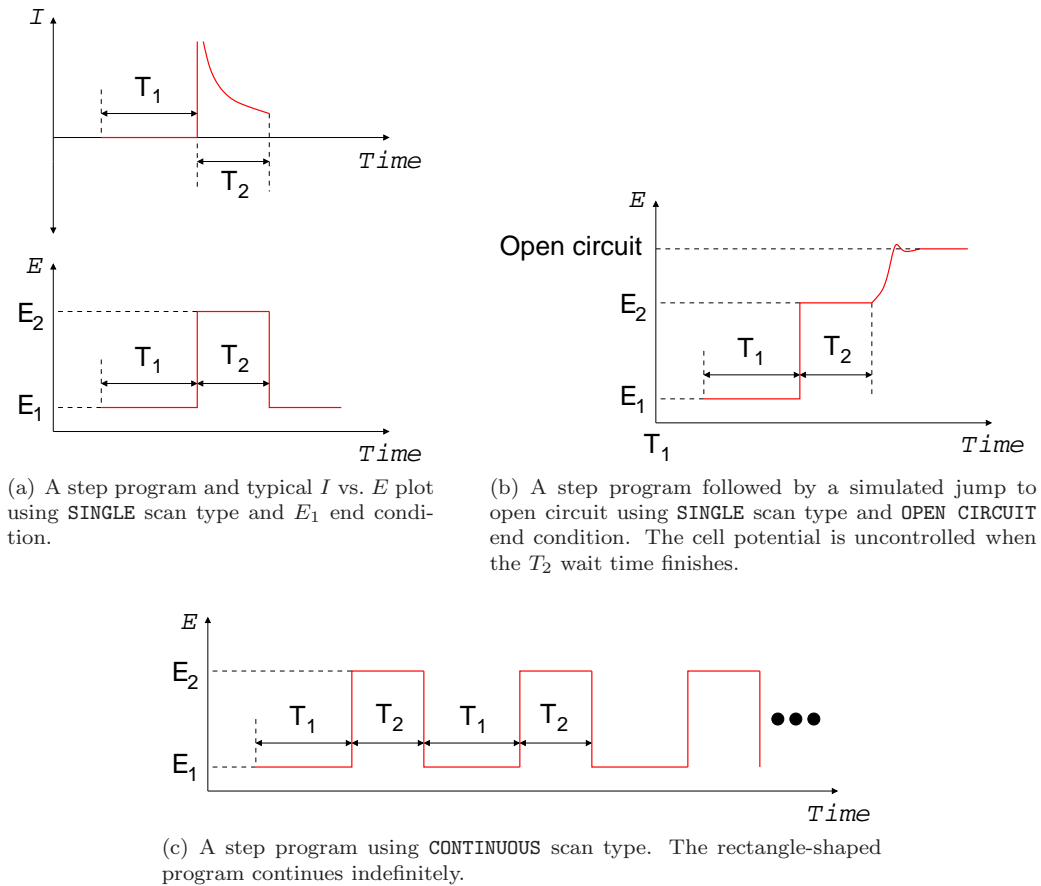
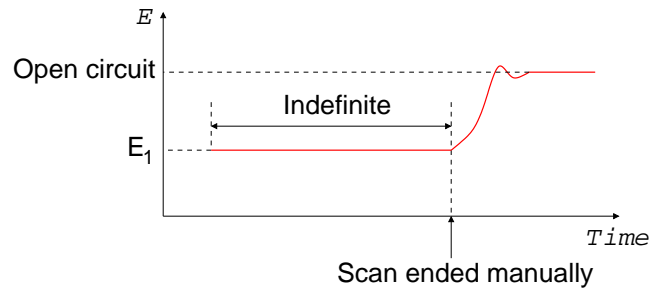

Figure 21: Parameters used to set up a step scan.

5.1.4 Holds

Figure 22 illustrates the parameters needed to specify holds or timed holds. These scans must end in the OPEN CIRCUIT condition, and the scan type can only be SINGLE. Only MANUAL trigger mode is allowed. The remaining setup procedure is as follows:

1. Use the [MODE] key to select HOLD or TIMED HOLD.
2. Set the E_1 and T_1 parameters using [SET] and the knob.
3. Choose the trigger mode. MANUAL allows the [GO/ARM] key or the remote interface to start the hold. See section 5.4 on page 65 for a better description of scan triggers. EXTERNAL mode is not allowed.



(a) A (indefinite) hold program. Holds must end in the OPEN CIRCUIT condition.

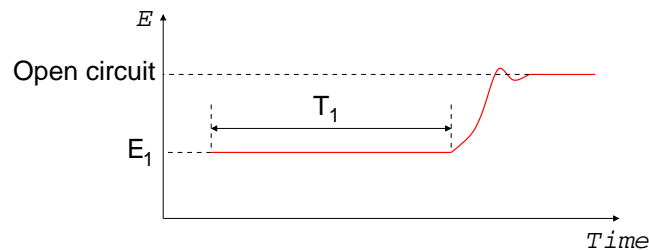

(b) A timed hold program. Control is automatically released after the T_1 hold time.

Figure 22: Parameters used to set up a regular and timed hold.

5.2 Setting scan parameters – galvanostat mode

5.2.1 Cyclic current ramp

Figure 23 illustrates the parameters needed to specify a cyclic current ramp scan. The procedure is as follows:

1. Use the [MODE] key to select CV. While this scan mode is named for its use in potentiostat mode, it will set up a cyclic current ramp in galvanostat mode.
2. Cycle through the required parameters using [SET], and adjust values using the knob.
3. Choose the scan end condition. Figure 23(a) illustrates the cell current for the I_1 end condition, while 23(b) shows it for OPEN CIRCUIT.
4. Choose SINGLE or CONTINUOUS scanning. Single scans, illustrated in figures 23(a) and (b), go to the end scan condition after reaching I_1 on the return ramp. Continuous scans, illustrated in figure 23(c), immediately turn around to repeat the forward ramp and then the entire triangle-shaped waveform.
5. Choose the trigger mode. MANUAL allows the [GO/ARM] key to trigger the scan, while EXTERNAL mode requires the rear panel scan trigger input. See section 5.4 on page 65 for a better description of scan triggers in general, and section 3.2.6 on page 38 for a description of the rear panel scan trigger.

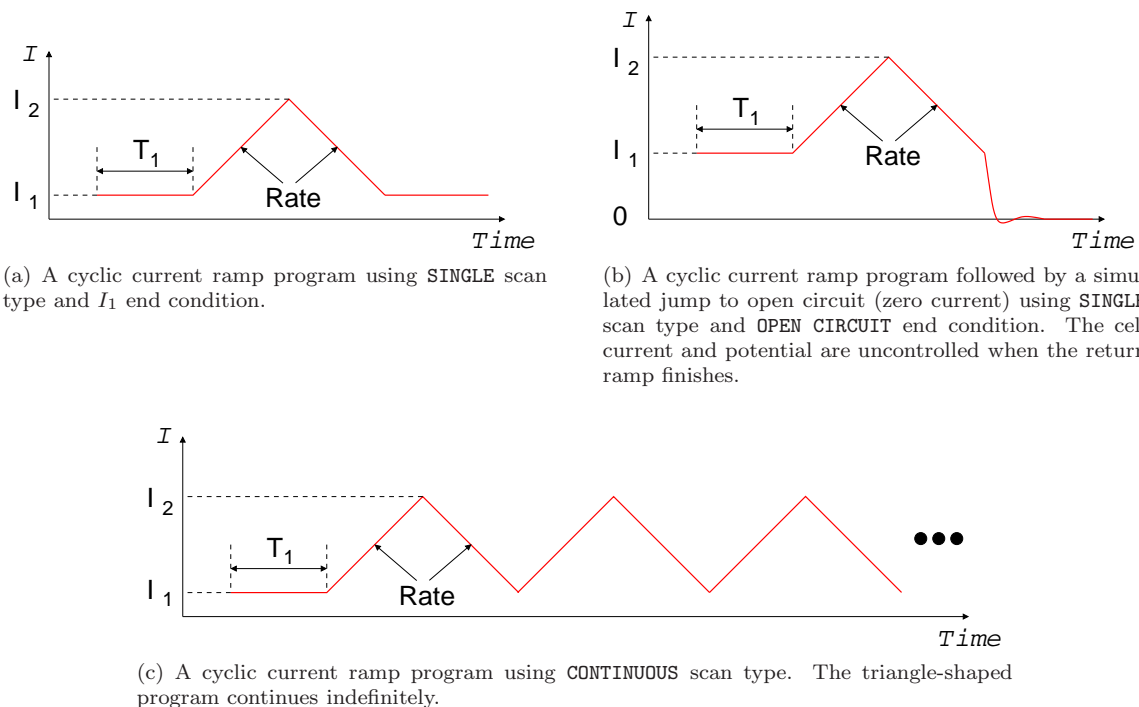

Figure 23: Parameters used to set up a cyclic current ramp scan.

5.2.2 Linear current ramp

Figure 24 illustrates the parameters needed to specify a linear current ramp scan. The procedure is as follows:

1. Use the [MODE] key to select LSV. While this scan mode is named for its use in potentiostat mode, it will set up a linear current ramp in galvanostat mode.
2. Cycle through the required parameters using [SET], and adjust values using the knob.
3. Choose the scan end condition. Figure 24(a) illustrates the cell potential for the I_1 end condition, while 24(b) shows it for OPEN CIRCUIT.
4. Choose SINGLE or CONTINUOUS scanning. Single scans, illustrated in figures 24(a) and (b), go to the end scan condition after the T_2 wait time. Continuous scans, illustrated in figure 24(c), track back to I_1 after the T_2 wait time with the same rate used for the forward ramp. They then repeat the entire program indefinitely.
5. Choose the trigger mode. MANUAL allows the [GO/ARM] key to trigger the scan, while EXTERNAL mode requires the rear panel scan trigger input. See section 5.4 on page 65 for a better description of scan triggers in general, and section 3.2.6 on page 38 for a description of the rear panel scan trigger.

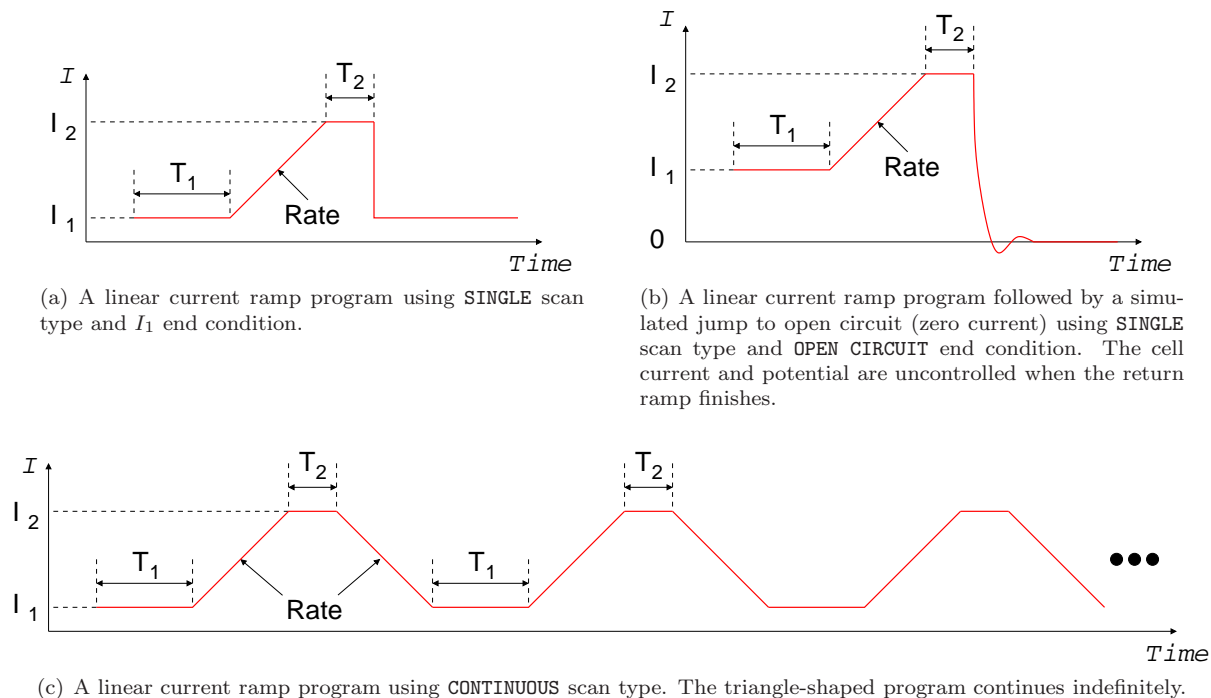
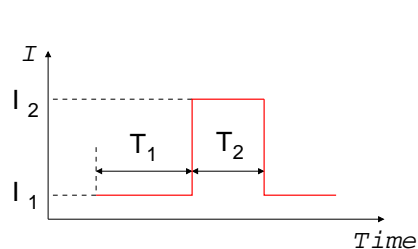

Figure 24: Parameters used to set up a linear current ramp scan.

5.2.3 Current step

Figure 25 illustrates the parameters needed to specify a current step scan. The procedure is as follows:

1. Use the [MODE] key to select **STEP**.
2. Cycle through the required parameters using [SET], and adjust values using the knob.
3. Choose the scan end condition. Figure 25(a) illustrates the cell potential for the I_1 end condition, while 25(b) shows it for **OPEN CIRCUIT**. If the end condition is **OPEN CIRCUIT**, the cell potential will be free to drift after the T_2 wait time. If the condition is I_1 , the potential will immediately return to I_1 .
4. Choose **SINGLE** or **CONTINUOUS** scanning. Single scans, illustrated in figures 25(a) and (b), go to the end scan condition after the T_2 wait time. Continuous scans, illustrated in figure 25(c), step back to I_1 after the T_2 wait time and repeat the entire step program indefinitely.
5. Choose the trigger mode. **MANUAL** allows the [GO/ARM] key to trigger the scan, while **EXTERNAL** mode requires the rear panel scan trigger input. See section 5.4 on page 65 for a better description of scan triggers in general, and section 3.2.6 on page 38 for a description of the rear panel scan trigger.



(a) A current step program using **SINGLE** scan type and E_1 end condition.

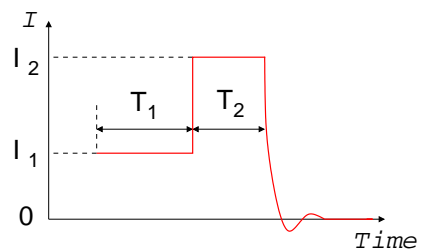

(b) A current step program followed by a simulated jump to open circuit using **SINGLE** scan type and **OPEN CIRCUIT** end condition. The cell current and potential are uncontrolled when the T_2 wait time finishes.

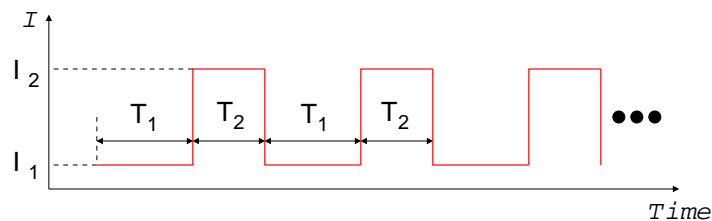

(c) A current step program using **CONTINUOUS** scan type. The rectangle-shaped program continues indefinitely.

Figure 25: Parameters used to set up a step scan.

5.2.4 Current hold

Figure 26 illustrates the parameters needed to specify current holds or timed holds. These scans must end in the OPEN CIRCUIT (zero current) condition, and the scan type can only be SINGLE. Only MANUAL trigger mode is allowed. The remaining setup procedure is as follows:

1. Use the [MODE] key to select HOLD or TIMED HOLD.
2. Set the I_1 and T_1 parameters using [SET] and the knob.
3. Choose the trigger mode. MANUAL allows the [GO/ARM] key or the remote interface to start the hold. See section 5.4 on page 65 for a better description of scan triggers. EXTERNAL mode is not allowed.

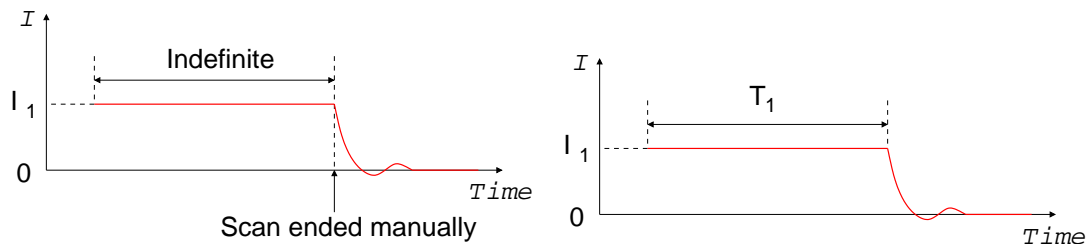

(a) A (indefinite) current hold program. Holds must end in the OPEN CIRCUIT (zero current) condition. (b) A timed current hold program. Control is automatically released after the T_1 hold time.

Figure 26: Parameters used to set up a regular and timed current hold.

5.3 Basic scan controls

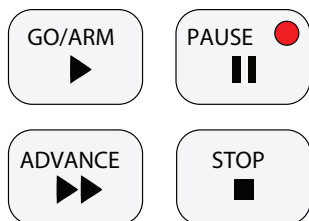

Once a scan is configured, the [GO/ARM], [PAUSE], [ADVANCE], and [STOP] keys control how it will execute.

Pressing the [GO/ARM] key is one way to send a scan trigger described in section 5.4. This will begin a scan in MANUAL trigger mode, or arm the instrument in EXTERNAL mode.

The [PAUSE] key freezes the scan wherever it happens to be. Pressing it again will resume the scan.

The [ADVANCE] key increments the scan stage. For example, pressing this during the forward ramp of a CV scan will start the return ramp. Pressing this during the return ramp will skip to the

end scan condition.

The [STOP] key terminates the scan and releases cell control. This does **not** simply take the scan to the scan end condition – control is always released. Use the [ADVANCE] key instead to skip to the end of a scan.

5.4 Triggering scans

A configured scan will start once the EC301 receives a scan trigger. This can come from the front panel [GO/ARM] button, the rear panel scan trigger input, or the remote interface.

5.4.1 Triggering a scan from the front panel

As described in section 3.1.14 on page 33, the front panel [GO/ARM] key will start a scan if the trigger mode is set to MANUAL. Pressing this in the EXTERNAL trigger mode will “arm” the instrument – control will engage but scanning will wait for the scan trigger input.



The [GO/ARM] key will try to engage cell control to begin a scan in both trigger modes – lighting the [ENABLE] switch. Make sure to allow this by pressing this switch to the “on” position.

5.4.2 Triggering a scan with the scan trigger input

As described in section 3.2.6 on page 38, the rear panel scan trigger input allows fine control over when the scan begins. This can help to synchronize external data acquisition during fast scans.

5.4.3 Triggering a scan from the remote interface

The scan trigger remote commands are described in section 8.3.6 on page 84.

5.5 Setting the end of scan condition

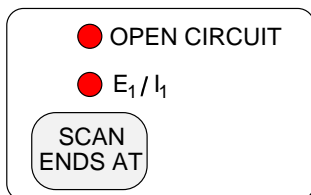

The EC301 can either retain or release control of a cell at the end of a scan. Retaining control may reduce drift in cell characteristics between scans, while releasing control may reduce stress on the cell. Select OPEN CIRCUIT to release control, or E_1/I_1 to retain control at the E_1 or I_1 setting.



Only OPEN CIRCUIT is allowed as an end condition for HOLD or TIMED HOLD scan modes.

6 Using the EC301 with an external frequency response analyzer (FRA)

The EC301 performs electrochemical impedance spectroscopy (EIS) measurements from millihertz to 100 kHz directly. To extend the frequency range up to 1 MHz, an external frequency response analyzer (FRA) can be used with the EC301. In this configuration, the FRA supplies the stimulus for these measurements via the external input, and measures the cell response via the E and I outputs. Figure 27 shows the EC301 used with an FRA for this purpose.

For best results, especially at high frequency, SRS recommends using the rear panel outputs for EIS measurements.

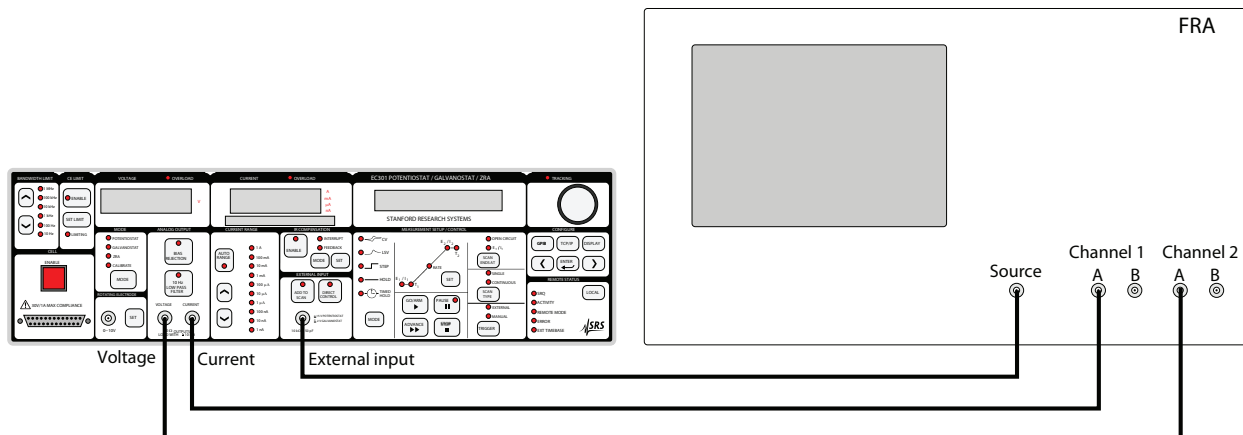

Figure 27: Using the EC301 with an FRA for impedance spectroscopy

Using the setup shown in figure 27, the FRA supplies the stimulus for swept-sine or FFT-based measurements via the external input BNC. It then can calculate the complex cell frequency response as

$$\text{Response} = \frac{\text{FFT2}}{\text{FFT1}} \quad (1)$$

for FFT-based measurements or as

$$\text{Response} = \frac{\text{spectrum2}}{\text{spectrum1}} \quad (2)$$

using the swept-sine mode. The cell impedance Z_{cell} can be calculated from this using

$$Z_{\text{cell}} = \frac{\text{spectrum2}}{I_{\text{fs}} \times \text{spectrum1}} \quad (3)$$

where I_{fs} is the current range (10mA, 100 μ A, etc).

7 Boosted current operation

You can increase the current compliance of the EC301 by adding an optional booster. The following booster models are available:

- BOP 20-20D (400 W, 20V/20A); order option **O400BST**
- BOP 20-10D (200 W, 20V/10A); order option **O200BST**
- BOP 20-05D (100 W, 20V/5A); order option **O100BST**

Please note that the EC301 and the booster are calibrated together at the factory, as a system. An EC301 can be retrofit with a booster, but the EC301 must be returned to the factory for system calibration.

WARNING — Electrocution Hazard

Remove AC power from the booster before making any connections. The booster chassis and cover must be safety grounded to a reliable earth ground.

The booster is capable of delivering high current. **Keep clear** of output terminals while the booster is running. **Always** turn off the booster while connecting, disconnecting, or working close to the load. **There are no user serviceable parts inside the booster or the EC301. Do not attempt to service either instrument.** Call SRS if the system requires service.

Wires and/or cables, connected from the booster terminals to external components or programming devices must be properly insulated and securely terminated at both ends to avoid accidental contact. **Do not use banana plugs with exposed screws or other exposed conductive metal parts at the output terminals.**



WARNING — Fire Hazard

The booster is capable of producing high power. Consider power dissipation in the load; dissipating excessive power can lead to a fire. Be sure to know how hot the load and terminal leads will become during an experiment. Consider the prospect of feedback being interrupted. It is generally good practice to set the EC301 compliance limit as low as the experiment will allow; if feedback is interrupted, the CE limit will prevent the full compliance power from being applied. **SRS recommends against operating a boosted system unattended.**



7.1 System installation

There are three connections that the system makes (see Figure 31); the signal lines between the external booster and the EC301, the power lines between the external booster and the interface card, and the terminal cable that connects the output from the interface card to your cell.

The signal cable is attached to the rear panel of the EC301 at the 9 pin D-sub connector labeled “BOOSTER INTERFACE” (see Figure 28).

The other end of the signal cable is attached to an interface card, housed in a plastic enclosure with a board-edge connector (see Figure 29). Note the plastic key near the bottom of the card edge connector in the image; the key should be at the bottom as you mate the card edge connector into the rear panel of the external booster.

The booster rear panel output attaches to the cable harness with spade terminals. Each terminal is labeled with “OUT”, “GRD”, or “COM”. Attach the wire lead with clear insulation (labeled “OUT”) to the screw terminal on the booster labeled “OUT”. Attach the wire with black insulation (labeled “COM”) to the screw terminal on the booster labeled “COM”. Attach the braided wire (labeled “GRD”) to the screw terminal on the booster labeled “GRD”. See Figure 30 for details.



Figure 28: Rear panel connector for booster interface.

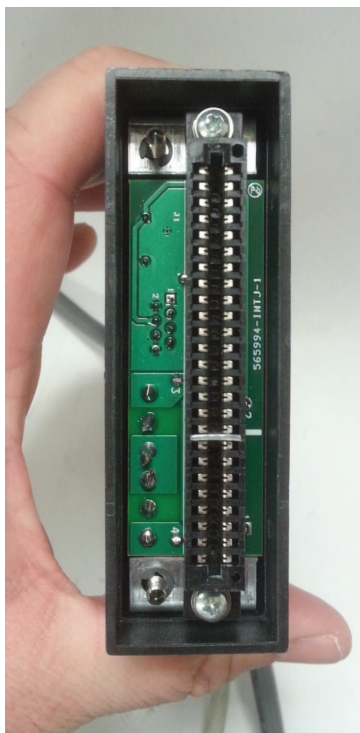

Figure 29: Interface card and edge connector for the external booster.

During boosted operation, the EC301 measures potential via the RE and WEsense input terminals of the EC19 (see Figure 31). However, the CE and WE terminals of the EC19 are **not** used. The booster output (red terminal, red alligator clip, “OUT”) acts as the counter electrode and the booster return (black terminal, black alligator clip, “COM”) acts as the working electrode.

7.2 Ventilation and cooling

It is important to ensure that none of the vent holes of either the EC301 or the external booster are blocked. During operation, the booster can internally dissipate hundreds of watts of electrical power. Before beginning any experiment, ensure the booster vent holes are free from obstructions. The recommended configuration is to site the EC301 on top of the booster chassis **with the bail extended** (see Figure 32) or place the instruments side by side. A rackmount configuration is also possible; contact SRS to order appropriate

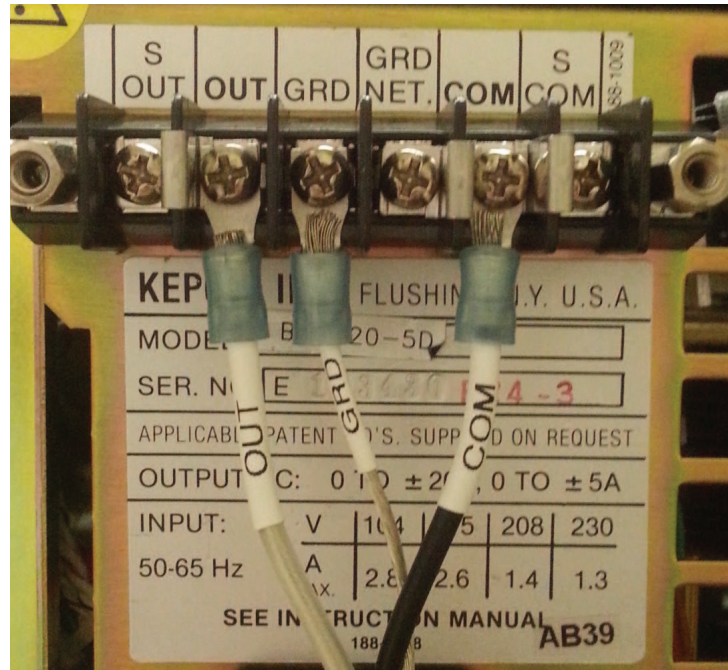

Figure 30: Terminal strip interface at rear panel of external booster.

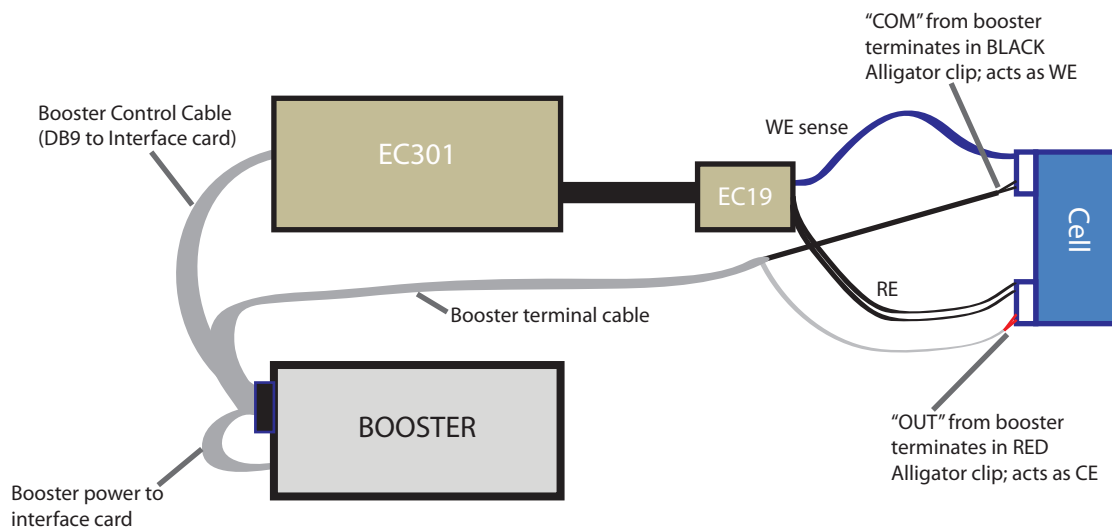

Figure 31: Boosted operation: cable arrangement.

hardware. If the rack mount configuration is used or if the system is operated in a confined space, care must be taken that the ambient temperature surrounding the external booster does not exceed 55 °C.

7.3 Entering boosted operation

Ensure the cables are attached as described in section 7.1. Make sure the booster is turned off.

To use a system outfitted with a booster, push the [DISPLAY] key on the front panel until you see



Figure 32: Boosted operation: recommended stack-up

“Booster:disabled” on the display. (If you see “Booster:none”, then your EC301 was not calibrated for operation with the booster. Contact SRS if you wish to order a booster.) Once you see the “Booster:disabled” message, the word “disabled” will be flashing—this indicates it is a parameter that can be changed. Turn the jogger knob to select boosted operation. You will see “BOP 20V-xxA”, where “xx” is either “05”, “10”, or “20”, depending on the maximum current of the booster you have in your system. Push the [ENTER] key to make the selection. Note that none of the indicator lamps on the current range indicator are illuminated in boosted operation. This indicates that the EC301 internal current-to-voltage circuitry is not in use. There is only one current range available and that is defined by the external booster. Because the system has reduced bandwidth, the maximum bandwidth stop available under boosted operation is 10 kHz. This bandwidth setting is automatically selected upon entering boosted operation. Once boosted operation is selected, turn on the booster. Proceed to section 7.7, Initial booster checkout, before performing experiments.

Once boosted mode is selected, the boosted operation setting will persist through power cycles. The EC301 will show “Boosted:BOP 20V-xxA” on the bottom line of the front panel vacuum fluorescent display to remind users that it is in boosted mode.

It is possible to enter booster mode via the remote command `BSTREN 1`. However, the user must be present to reconfigure the cable arrangement between normal operation and boosted operation. The CE and WE leads from the EC19 should **not** be attached to the load during boosted operation, but the CE and WE leads from the EC19 **must** be attached during normal operation. The OUT and COM leads from the booster should **not** be attached during normal operation, but they **must** be attached to the load during boosted operation.

See the important note in section 7.6 on side effects from the remote `*RST` command when operating in boosted mode.

7.4 Current interrupt under boosted operation

Current interrupt under boosted operation is achieved using a hardware relay switch installed on the interface card. The relay hardware has finite operation time for opening and closing, which imposes additional restrictions when performing current interrupt measurements. The EC301 automatically compensates for this by limiting current interrupt to no faster than 200 ms (5 Hz) when operating in boosted mode. The minimum open time is 10 milliseconds. See the documentation for remote commands `CIOPEN`, `CIDLAY`, and `CIPERD` for further details.

Also note that the hardware relay is an electromechanical device and subject to wear. It is not recommended to run current interrupt for extended periods while under boosted operation as this will shorten the life of the relay. If you return the EC301 to normal (non-boosted) operation, be sure to remove the D-sub cable connection from the rear panel of the EC301. Otherwise, although the system will continue to perform normally, the hardware relay will continue to actuate with every open and close cycle of the counter electrode (even though the booster is not being used). This will needlessly shorten the operating life of the relay.

7.5 Bandwidth limitation under boosted operation

Once the system enters boosted operation, the EC301 limits the bandwidth selection to no greater than 10 kHz. While boosted, if the user attempts to increase the bandwidth setting above 10 kHz from the front panel or the remote interface, an error is triggered. If the system is returned to normal operation, then bandwidth settings up to 1 MHz are again available as usual.

7.6 Returning to normal operation

Before returning to normal operation, make sure the booster is turned off. Disconnect the booster interface cable from the D-sub connector labeled “BOOSTER INTERFACE” on the rear panel of the EC301. Disconnect the booster terminal cables from the cell. Re-attach the WE and CE terminal cables to the EC19 and attach them to the cell. Push the [DISPLAY] key until you see “Booster:BOP 20V-xxA” where “xx” is “05”, “10”, or “20” depending on the booster you have installed in your system. Turn the jogger knob to select “Booster:disabled”. Push the [ENTER] key. Note that the 1A range indicator lamp will illuminate to indicate that the EC301 current-to-voltage circuitry is now in use.



Note that sending the remote command *RST will return the unit to its default state, including being in normal (non-boosted) operation. Users should **not** use *RST to remotely switch from boosted to normal operation because the cable configuration must change: the CE and WE leads from the EC19 should **not** be attached to the load during boosted operation, but the CE and WE leads from the EC19 **must** be attached to the load during normal operation.

If your remote programs use the *RST command under boosted operation, **always** follow the *RST command with the BSTREN 1 command to return the EC301 into the boosted configuration.

7.7 Initial booster checkout

The following two procedures should be followed upon first setting up a new EC301 with external booster.

7.7.1 Open circuit test

Make sure the booster is off.

1. Connect the booster to the EC301 and connect the booster terminal cables to the booster.
2. Connect the EC19 WEsense lead (blue) to the black COM terminal of the booster. Connect the EC19 RE lead (white) to the red OUT terminal of the booster.

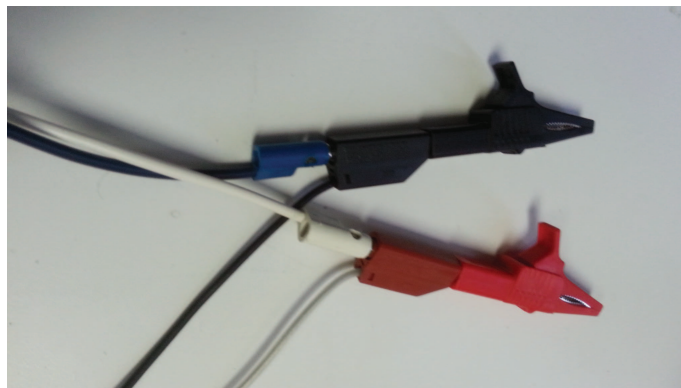

3. Put the EC301 into boosted operation mode (see section 7.3. Set the feedback mode of the EC301 to potentiostat by pushing the [MODE] key on the front panel under the mode group until “potentiostat” is selected.
4. Select an infinite hold waveform by pushing the [MODE] key under the waveform setup and control group until the “HOLD” waveform is selected.
5. Push the [SET] key under the waveform setup and control group. Use the jogger to dial E1 to +15V.
6. Ensure the [ENABLE] switch on the front panel is pushed in. Turn on the booster.
7. Push the [GO/ARM] key on the front panel.

The EC301 should display a voltage on the seven segment numeric display very close to +15V. The booster voltage readout will have opposite polarity from the EC301 voltage readout. This is because the EC301 voltage is referenced to RE, whereas the booster voltage reference will be referenced to WEsense. There may be a minor discrepancy in the absolute value between the EC301 voltage readout and the booster voltage readout. This is a result of the EC301 using a tighter calibration than the booster. The “CE LIMITING” indicator lamp on the EC301 should be off. The current and voltage limit indicator lamps on the booster should also be off. If any of these indicators are illuminated or if the output voltage reading is not the correct value or is not steady, **STOP**. Call SRS to troubleshoot the issue.

If there are no fault conditions, repeat the process a second time, selecting $-15V$ for the E1 potential.

7.7.2 Short circuit test

Make sure the booster is off.

1. If not already done, connect the booster to the EC301, and connect the booster terminal cables to the booster.
2. Electrically connect the red terminal cable to the black terminal cable by using the supplied alligator clips and clip each cable to a short (3 inch or less) section of 14 AWG wire. Such a piece is supplied with the booster. *It is not recommended to create the connection by clipping the alligator clips directly together without a wire, since they may not make reliable contact to each other.*

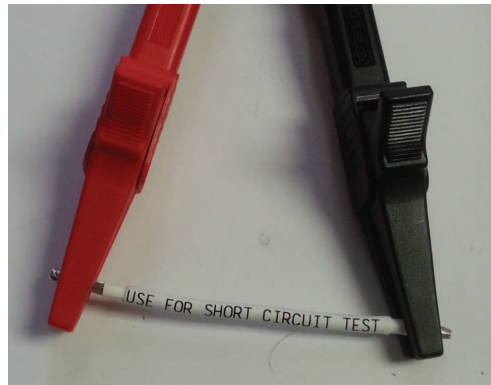

3. Put the EC301 into boosted operation mode. (see section 7.3).
4. On the front panel of the EC301, push the down arrow key in the Bandwidth Limit group (upper left corner of the front panel) until the 10 Hz bandwidth is selected.
5. Set the feedback mode of the EC301 to galvanostat by pushing the [MODE] key on the front panel under the mode group until “galvanostat” is selected.

6. Select an infinite hold waveform by pushing the [MODE] key under the waveform setup and control group until the “HOLD” waveform is selected. Push the [SET] key under the waveform setup and control group.
7. Use the jogger to dial I1 to the maximum current for your booster (e.g., for a 20V/20A booster, use +20A).
8. Ensure the [ENABLE] switch on the front panel is pushed in. Turn on the booster.
9. Push the [GO/ARM] key on the front panel.

The EC301 should display a current on the seven segment numeric display very close to the setting. There may be a minor discrepancy between the booster current readout and the EC301 current readout. This is a result of the EC301 using a tighter calibration than the booster. The “CE LIMITING” indicator lamp on the EC301 should be off. The current and voltage limit indicator lamps on the booster should also be off. If any of these indicators are illuminated or if the output voltage reading is not the correct value or is not steady, **STOP**. Call SRS to troubleshoot the issue.

If there are no fault conditions, repeat the process a second time, selecting the maximum negative current (e.g., for a 20V/20A booster, use $-20A$).

8 Remote programming

The EC301 may be remotely programmed via either the GPIB or ethernet interfaces.

When using the ethernet interface, be advised that some “personal firewall” systems will terminate idle connections.

8.1 Command syntax

Communication with the EC301 is done with ASCII characters. Commands may be in either UPPER or lower case and may contain any number of embedded space characters. For example, the commands

```
ECMODE 1
ECMODE    1
ecmode  1
```

will all put the instrument in galvanostat mode.

Multiple commands may be sent on one command line by separating them with semicolons (;). The individually-sent commands

```
ecmode 1
clbwth 4
irange 1
```

can be sent simultaneously with

```
ecmode 1;clbwth 4;irange 1
```

following which the EC301 will buffer and then execute the command string from left to right.

8.2 Argument formats

Table 3 summarizes the number formats expected for each argument designator.

Argument designators	Format	Good examples	Unrecognized
i, j, k	integer	-1200, 0, 1, 5, +6	-1.2e3, 0x5
x, y, z	real number	-1.34, 0.0, 3.14159	

Table 3: Number formats expected for each argument designator.



Numbers written in scientific notation will not be recognized as allowed arguments.

8.3 Detailed command list

8.3.1 Firmware and hardware revisions

fgarv? **Name:** fgarv? – Query the FPGA revision number.
Description: The instrument's FPGA revision number is important for firmware upgrades.

8.3.2 Program E/I setup (with external input)

setvol(?) – Set or query DC bias voltage.
Description: This command provides an easy way to control a DC voltage without setting up a scan.

Parameter	Units	Range
i	mV	−15000, −14999, −14998, ⋯, +15000

For example, the sequence

`setvol(?) {i}`

```
ecmode 0
ceenab 1
setvol 1000
setvol?
1000
```

will set up a program voltage of 1V in potentiostat mode. The `setvol?` query command will return a value in the same format as the setting. This command is not allowed in galvanostat mode, zra mode, or if the unit is in direct control mode.

Name: `setcur(?)` – Set or query DC bias for the current program in galvanostat mode.

Description: This command provides an easy way to control a DC current without setting up a scan.

Parameter	Units	Range
x	fraction of range	-2 → +2

For example, the sequence

```
setcur(?) {x}
ecmode 1
ceenab 1
irange 4
setcur 0.543
setcur?
5.43e-4
```

will set up a program current of 0.543mA in galvanostat mode. The argument to `setcur` is the signed floating-point fraction of the current range. Since `irange 4` chooses the 1mA range, an argument of 0.543 sets a control current of $0.543 \times 1\text{mA} = 543\mu\text{A}$. The `setcur?` query command will return the actual setpoint in A instead of the fraction of full scale. This command is not allowed in potentiostat or zra mode.

The command functions the same way under boosted operation. Bear in mind, each booster's maximum current is treated as two times its full scale current. For example, if you are using the 20V/20A booster and send `setcur 1.0`, you will generate +10A of current. If you are using the 20V/5A booster and send `setcur 1.0`, you will generate 2.5A of current.

Name: `addscn(?)` – Set or query the external input's "add to scan" mode.

Description: This command enables or disables the external input without affecting the state of the control loop.

i	Setting
0	Voltage at external input ignored
1	Voltage at external input added to scan or hold

```
addscn(?) {i}
```

This is useful for adding a waveform from an external source to a ramp generated by the EC301. For example, a sine wave could be added to a ramp for AC voltammetry. Changing the `addscn` state will turn the external waveform on or off without affecting the EC301's waveform. If -1V is applied to the external input, the sequence

```
ecmode 0
setvol +1000
ceenab 1
addscn 1
```

will result in 0V over the cell.

Name: `dcntrl(?)` – Set or query the external input’s “direct control” mode.

Description: This command enables or disables the external input while engaging and disengaging cell control.

i	Setting
0	Voltage at external input ignored
1	Voltage at external input applied to cell

`dcntrl(?) {i}`

This is useful when you have an external source for your entire stimulus and you don’t want to use the internal sources. Sending `dcntrl 1` works like pushing [DIRECT CONTROL] on the front panel – the control loop will close with the control voltage taken from the external input BNC. However, sending `dcntrl 0` will only open the control loop if the external input has been put in charge with `dcntrl 1` – not if an internally-generated scan or hold is running.



This command will generate an error if an internally-generated scan or hold is already running. Make sure all control has been released before sending `dcntrl 1`.

Name: `progrm?` – Read the program E/I voltage.

Description: This command queries the total voltage program input to the control loop.

Parameter	Units	Range
x	V	-15.000 → +15.000

`progrm?`

The program input is the sum of voltages from the external input BNC and from internal sources. This command is useful during current interrupt IR compensation, as the values returned should represent the cell voltage with any IR drop removed. Returned values are formatted as floating-point volts. For example, the sequence

```
ecmode 0
setvol 123
progrm?
+0.123
```

calls for +123mV to be applied to the cell in potentiostat mode. If there is no external input voltage, the return value of `progrm?` will be `+0.123`.

8.3.3 Control loop commands

Name: `ecmode(?)` – Set or query the control loop mode.

Description: The control loop can take its feedback from one of three sources, resulting in the three modes described below.

`ecmode(?) {i}`

i	Mode
0	Potentiostat
1	Galvanostat
2	Zero-resistance ammeter (ZRA)

Name: `clbwth(?)` – Set or query the control bandwidth.

Description: Set or query the control loop bandwidth.

`clbwth(?) {i}`

i	Control loop bandwidth
0	1 MHz
1	100 kHz
2	10 kHz
3	1 kHz
4	100 Hz
5	10 Hz

Name: `celimt(?)` – Enables or disables CE voltage limiting mode.

Description: Sending this command is identical to using the front panel [ENABLE] key in the CE LIMIT group. See the description in section 3.1.3 on page 25 for more information.

`celimt(?) {i}`

i	Setting
0	Disable – full $\pm 30\text{V}$ compliance
1	Enable – CE voltage limit set with front panel or <code>celimv</code> command.

Name: `celimv(?)` – Set the CE voltage clamp limits.

Description: The CE limits are symmetric about SIGNAL GROUND. For example, the command `celimv 1000` will limit the CE voltage to $\pm 1\text{V}$ of SIGNAL GROUND.

`celimv(?) {i}`

Parameter	Units	Range
x	mV	500, 501, 502, \dots , 30000

Name: `limitg?` – Query if the CE Limit is active.

`limitg?`

Description: `limitg?` returns 1 if the CE limit is active, 0 if the limit is inactive. Use the `celimt` command to enable or disable the CE limiting.

8.3.4 Cell switch

Name: `ceenab(?)` – Set or query the CE switch position.

Description: Enable or disable the cell. The red “enable” switch on the front panel will illuminate if the cell is enabled and the switch is pushed in.

`ceenab(?) {i}`

i	Cell connection
0	Disabled
1	Enabled

Name: `cellon?` – Query the cell connection.

Description: This query-only command returns the state of the cell connection. As shown in figure 1 on page 21, this connection is made only if both the current interrupt cell switch and the front panel safety switch are closed. Since the safety switch lights up only when both of these are closed, this query tells you whether or not this light is on.

`cellon? {i}`

i	Cell connection
0	Disconnected – Either the current interrupt cell switch or the front panel safety switch is open (safety switch red light is off).
1	Connected – Both the current interrupt cell switch and the front panel safety switch are closed (safety switch red light is on).

8.3.5 IR compensation

Name: `irenab(?)` – Enable or disable IR compensation.

Description: Enable or disable either mode of IR compensation. This corresponds to pushing the front panel [ENABLE] key described in section 3.1.12 on page 30.

`irenab(?) {i}`

i	Setting
0	Disable IR compensation
1	Enable IR compensation

Name: `irtype(?)` – Set or query the IR compensation mode.

Description: Set or query the IR compensation mode. This corresponds to pushing the front panel [MODE] key described in section 3.1.12 on page 30.

`irtype(?) {i}`

i	Setting
0	Current interrupt
1	Positive feedback

Name: `pfback(?)` – Set the positive feedback amount.

Description: No description.

`pfback(?) {x}`

Parameter	Units	Range
x	none	0 → fff

Name: `ciopen(?)` – Set or query the CE switch open time for current interrupt.

Description: This command sets or queries the “interruption” time for current interrupt IR compensation. The resolution is $100\mu\text{s}$. This corresponds to the t_{open} delay shown in figure 6 on page 30.

Parameter	Units	Range
i	μs	100, 200, 300, \dots , 1×10^6 (1s)

`ciopen(?) {i}`

Note that under boosted operation, the parameter `i` is limited to a minimum value of 10000 ($10,000\mu\text{s}$, or 10 ms).



The interruption time must be shorter than the time between interrupts. Be sure to set a valid value for `ciperd` after setting `ciopen`.

Name: `ciperd(?)` – Set or query the interruption frequency for current interrupt.

Description: This command sets or queries the t_p period described in figure 6 on page 30. This is the time between interrupt cycles, set with 1ms resolution.

Parameter	Units	Range
i	ms	1, 2, 3, ..., 10000

Note that in boosted operation, the parameter i is limited to a minimum value of 200 (200 ms).

`ciperd(?) {i}`



The time between interrupt cycles (t_p) must be longer than the interruption time (t_{open}). Be sure to set a valid value for `cipopen` (described on the preceding page) after setting `ciperd` (described on the current page).

Name: `cicorr(?)` – Set or query the correction percentage used for current interrupt IR compensation.

Description: As described in section 3.1.12 on page 30, a fraction of ΔV_{ir} is added to the program voltage after current interruptions. Sending `cicorr 0` will make $\Delta V_b = 0$, and sending `cicorr 100` will make $\Delta V_b = \Delta V_{ir}$.

`cicorr(?) {i}`

Parameter	Units	Range
i	%	0, 1, 2, ..., 200

Name: `cidlay(?)` – Set or query the voltage sampling times used during current interrupt IR compensation.

Description: This command sets the t_{do} and t_{dc} sample delays described in figure 6 on page 30. Both sample delays are entered in integer μs .

i	Delay	Units	j
0	t_{do} (open delay)	μs	0, 1, 2, ..., 1×10^6 (1s)
1	t_{dc} (closed delay)		

`cidlay(?) {i} {j}`

Note that in boosted operation, `CIDLAY 0` (the delay after the relay opens before sampling begins), the parameter value j is limited to a minimum of 10000 (10,000 μs , or 10 ms). This additional restriction accommodates the 10 ms time needed for the relay to open under boosted operation.

Under boosted operation, `CIDLAY 1` (the delay after the relay closes before sampling begins), the parameter value j is limited to a minimum of 20000 (20,000 μs , or 20 ms). This additional restriction accommodates the 20 ms time needed for the relay to close under boosted operation.

8.3.6 Scan trigger commands

Name: `trgarm(?)` – Set or query the scan trigger arm condition.

Description: The instrument must be armed before a scan can be started with an external trigger. The armed instrument will wait for a trigger edge before scanning. This command will set or query this waiting (armed) state. See section 3.1.14 on page 33 for more information about the external trigger setting. See section 3.2.6 on page 38 for more information about the rear panel scan trigger input.

`trgarm(?) {i}`

i	Mode
0	Unarmed
1	Armed – waiting for external scan trigger

Name: `scntrg(?)` – Query the scan trigger state (are we scanning?).

Description: This command will tell you if the instrument is running an automatic scan.

`scntrg?`

Return value	Mode
0	Not triggered
1	Triggered (scanning)

Name: `stsync(?)` – Set or query whether software triggered scans are synchronized with the power line cycle.

Description: If the argument to STSYNC is 1, a remote command software-triggered scan (i.e. not triggered from the front panel) will not begin until the power line cycle measuring circuit detects a zero crossing. This allows the user to synchronize a fast cyclic voltammogram to occur at the same point in a power line cycle each time such a trigger is issued. The default is *not* to gate with the power line cycle, and begin the scan immediately.

`stsync(?) {i}`

i	Mode
0	No power line synchronization
1	Software triggered scans aligned to power line cycle

8.3.7 Rotating working electrode commands

Name: rotate(?) – Set or query the rotator output voltage.

Description: No description.

rotate(?) {x}

Parameter	Units	Range
x	mV	0 → 10000

8.3.8 Analog output commands

Name: `brenab` – Set or query the use of bias rejection.

Description: The EC301 uses bias rejection to remove DC voltages from the front panel `VOLTAGE` and `CURRENT` outputs.

i	Mode
0	Bias rejection disabled
1	Automatic bias rejection

Sending `brenab 1` begins automatic bias rejection by triggering a measurement of the front panel `VOLTAGE` and `CURRENT` signals. This is a simple detection of the constant component (bias) of these signals. Once this bias is detected, the EC301 attempts to null (reject) it by adding constant voltages to the BNC outputs.

Custom bias rejection amounts can be entered with the `bireje` command, described on page 86, and the `bireji` command, described on page 87. Note that you can only use these commands after sending `brenab 1` to turn bias rejection on.

`brenab(?) {i}`

Example:

```
setvol 1000 Programs a +1V controlled voltage in potentiostat mode.
ceenab 1 Closes the cell switch to engage control.
brenab 1 Begins automatic bias rejection
brenab? Is bias rejection enabled?
1 Yes, it is.
bireje? What is the nulling voltage applied to VOLTAGE ?
-998 Automatically applied value in mV.
bireje -1000 Send a custom nulling value for the VOLTAGE output.
bireje? What is the nulling voltage applied to VOLTAGE ?
-1000
bireji? What is the nulling voltage applied to CURRENT ?
-0.87 Automatically applied value in V – 1V is full scale current.
brenab 0 Turn off bias rejection.
bireje 1000 Trying to set a custom nulling voltage...
remote command error ...returns an error since rejection has been turned off.
```

Name: `bireje(?)` – Set or query the amount of E bias rejection.

Description: Sets or queries the amount of bias rejection applied to the front panel `VOLTAGE` output. Accepts an argument in fixed point millivolts. The `brenab` command described on page 86 must be sent before this command can be used.

`bireje(?) {x}`

Parameter	Units	Range
x	V	-15000 → +15000

Name: `bireji(?)` – Set or query the amount of I bias rejection.

`bireji(?) {x}`

Description: Sets or queries the amount of bias rejection applied to the front panel `CURRENT` output. The `brenab` command described on page 86 must be sent before this command can be used. The argument is in floating point, and indicates what fraction of full scale current will be rejected.

Parameter	Units	Range
x	fraction of full scale	-2.000 → +2.000

Name: `lpfile(?)` – Set or query the front panel *E* low pass filter status.

Description: No description.

`lpfile(?) {i}`

i	Setting
0	No filter
1	10Hz lowpass

Name: `lpfili(?)` – Set or query the front panel *I* low pass filter status.

Description: No description.

`lpfili(?) {i}`

i	Setting
0	No filter
1	10Hz lowpass

8.3.9 Voltage (E) measurement setup

Name: eadcrg(?) – Set or query the full-scale range of the internal E measurement.

Description: The instrument defaults to a $\pm 15\text{V}$ measurement range. This can be reduced to increase measurement resolution.

eadcrg(?) {i}

i	Setting
0	$\pm 2\text{ V}$
1	$\pm 5\text{ V}$
2	$\pm 15\text{ V}$

Name: eadcf1(?) – Set or query the low pass filter in front of the E ADC.

Description: No description.

eadcf1(?) {i}

i	Setting
0	No filter
1	10Hz lowpass
2	10kHz lowpass (anti-alias)

8.3.10 Current (I) measurement setup

Name: `irange(?)` – Set or query the current range.

Description: No description.

`irange(?) {i}`

i	Current range
1	1A
2	100mA
3	10mA
4	1mA
5	100 μ A
6	10 μ A
7	1 μ A
8	100nA
9	10nA
10	1nA
11	Boosted operation, 2.5A
12	Boosted operation, 5A
13	Boosted operation, 10A



You cannot do `irange` if you are autoranging or if you are using a booster.

Name: `iadcfl(?)` – Set or query the low pass filter in front of the I ADC.

Description: No description.

`iadcfl(?) {i}`

i	Setting
0	10Hz lowpass
1	No filter
2	10kHz lowpass (anti-alias)

Name: `irnaut(?)` – Set or query the I autoranging mode.

Description: The current measurement circuit can automatically change ranges when the measured current is at the extreme end of a range.

i	Autoranging
0	Off
1	On

`irnaut(?) {i}`

Autoranging of the I/V converter is disallowed if any of these conditions are true:



- Galvanostat mode is in use.
- Positive feedback IR compensation is in use.
- Bias rejection is in use.
- A booster is in use.

8.3.11 Reading single measurement results

Name: vlevel? – return an E measurement.

Description: This query only command takes no arguments and returns a floating point number in volts. For example, if $(V_{WE\ SENSE} - V_{RE})$ happens to be -1.543V, the sequence

vlevel?

```
vlevel?
-1.543
```

will return that value.

Name: ilevel? – return an I measurement.

Description: This query only command takes no arguments and returns a floating point number in amps. For example, if I_{WE} happens to be -1.543mA, the sequence

ilevel?

```
ilevel?
-1.543e-3
```

will return that value.

Name: getaux? – Get voltages from the rear panel auxiliary input BNCs.

Description: This query-only command returns voltage measurements made with the rear panel auxiliary input BNCs described on page 42.

getaux?*{i}*

i	Voltage returned
1	Auxiliary input 1
2	Auxiliary input 2
3	Auxiliary input 3
4	Comma delimited values from all three channels

Example:

```
getaux? 1 Query the voltage at auxiliary input BNC 1
1.723993 Volts
```

Name: `avgexp(?)` – Set or query the running average length.

Description: Sets or queries the number of data points averaged to make a measurement result. The averaged number is 2^i .

Parameter	Range
<code>i</code>	0,1,2,...,8

For example, the sequence

```
avgexp 4
```

`avgexp(?) {i}`

will make every measurement returned over the remote interface an average of $2^4 = 16$ internal measurements.

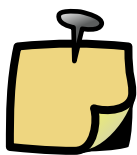

Sending `avgexp` clears the instrument's existing averaged data memory. New measurement results won't be accurate until the memory is allowed to refill, which takes ~ 30 ms. Please wait at least 30ms after sending `avgexp` to ensure that measurement results are accurate.

8.3.12 Streaming data

Name: `getbda` – Start or stop binary data streaming.

Description: This command is intended for users writing their own data acquisition software. See figure 33 on page 94 for an overview of data packets used for streaming.

`getbda{i}`

i	Action
0	Stop streaming data
1	Start streaming data

Name: `polbda?` – Get a single packet of binary data.

Description: This command is intended for users writing their own data acquisition software. See figure 33 on page 94 for an overview of data packets used for streaming. While the `getbda?` command (page 93) tells the instrument to start streaming an indefinite number of data packets, `polbda` asks for just one. This is useful for “polling” data acquisition, in which the host PC sends `polbda?` over and over again to collect data.

`polbda?`

Name: `getbdp?` – Query the binary data streaming protocol.

Description: This query-only command is used by host software to interpret streaming binary data. This manual documents protocol 2.

`getbdp?{i}`



Binary data streams in from the EC301 least significant bit (LSB) first, and that may cause some confusion with binary → hexadecimal converters that operate byte-by-byte. For example, if the EC301 wants to send `0xdeadbeef`, it will send

MSB, arrives last → `11011110101011011011111011101111` ← LSB, arrives first

...and the byte-by-byte hexadecimal conversion will make this `0xefbeadde`. You have to reverse the byte order inside each streamed word to recover the correct value.

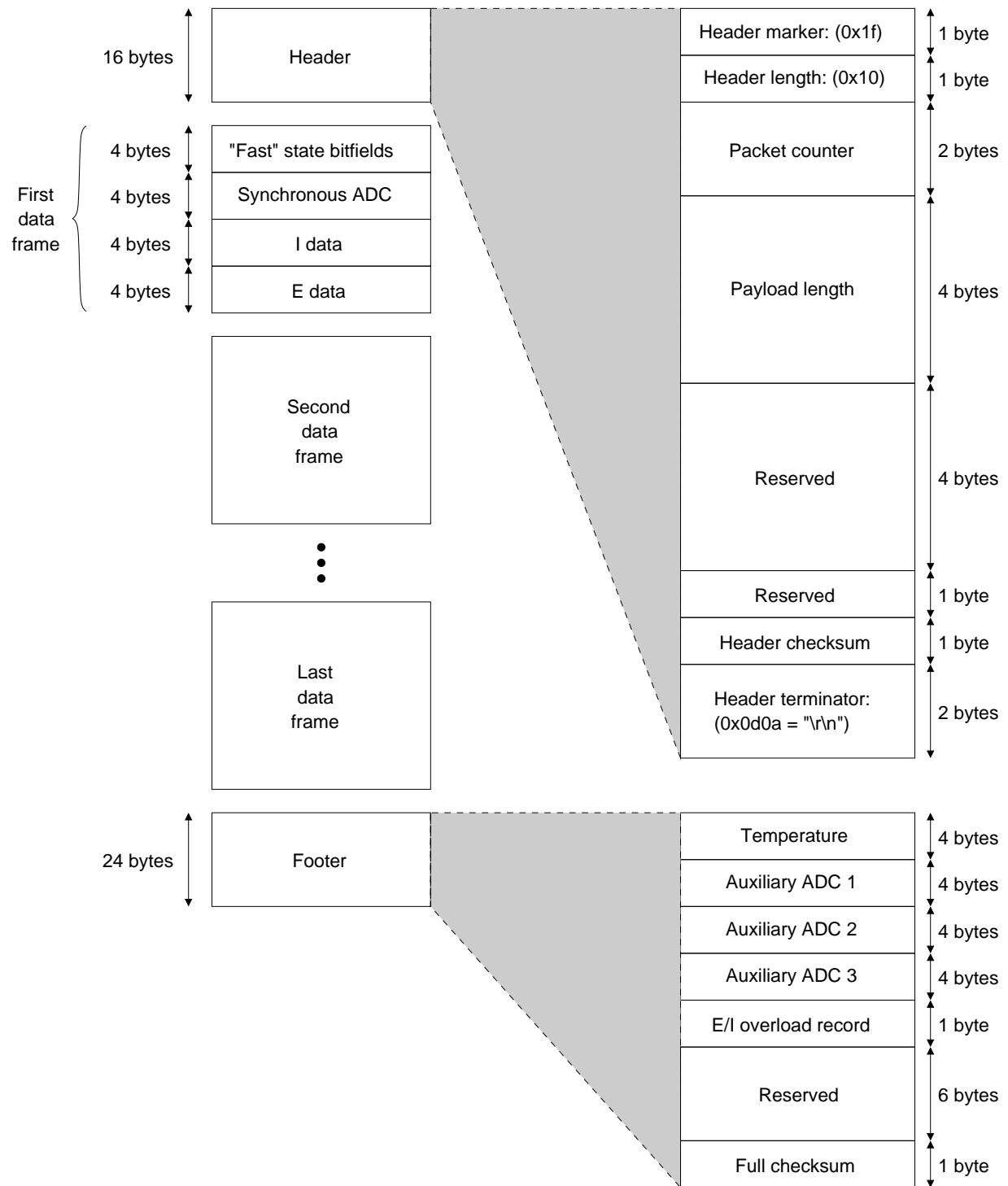

Figure 33: Basic construction of the data packet used for streaming data. The four bytes of “fast” instrument state in each data frame are described in table 4 on page 95. The E/I overload record byte in the footer is described in table 5 on page 96.

Bit	Quantity	Values
0	Cell switch position	0 On (closed) 1 Off (open)
1	Internal use	Internal use
2	Power line synchronization toggle	Toggle after each zero crossing
3	Compliance limiting status	0 Not limiting 1 Limiting
4:7	Current (I) range	1 1A 2 100mA 3 10mA 4 1mA 5 100 μ A 6 10 μ A 7 1 μ A 8 100nA 9 10nA 10 1nA 11 2.5A (boosted) 12 5A (boosted) 13 10A (boosted)
8:10	Voltage (E) range	3 2V 5 5V 6 15V
11	Ramp waveform generator status	0 Idle 1 Running
12	Ramp waveform synchronization toggle	Toggle after ramps begin and repeat
13:14	Internal use	Internal use
15:18	Data averaging window width	N 2^N points wide
19	Pulse waveform generator status	0 Idle 1 Running
20	Pulse waveform edge toggle	Toggle after each edge
21	Pulse waveform synchronization toggle	Toggle after pulse waveforms begin and repeat
22	Arbitrary waveform generator status	0 Idle 1 Running
23	Arbitrary waveform synchronization toggle	Toggle after arbitrary waveforms begin and repeat
24:31	Internal use	Internal use

Bit	Quantity	Values
0:1	Reserved	Reserved
2	E overload record	0 No overloads detected during the last packet. 1 One or more overloads detected during the last packet.
3	I overload record	0 No overloads detected during the last packet. 1 One or more overloads detected during the last packet.
4:7	Reserved	Reserved

Table 5: Bit positions in the E/I overload record byte.

8.3.13 Remote interface commands

Name: *IDN? – return the EC301’s device identification string.
Description: This query only command takes no arguments and returns the device identification string.

*IDN?

Name: *RST – Reset the EC301 to its default configuration.
Description: This command sets all modes and settings to their default configurations and values.

*RST

Name: *TST? – return the Power-on Self Test (POST) results.
Description: This command has no description.

*TST?

Name: *OPC(?) – Operation complete.

Description: This command is implemented for compatibility with the IEEE-488 standard. The original intent was for *OPC? queries to indicate when a long process was complete. The EC301 executes commands as it receives them though, and so the *OPC? query will be always be processed after the long process finishes. These queries will thus always return 1, indicating that all previous operations are complete.

*OPC(?)

This command can still be used to indicate when the instrument is ready to process new commands. In this example,

```
*OPC?
Long process finishes...
1
```

waiting for the 1 to be returned would indicate completion of all commands. The non-query version of the command simply sets the *OPC bit in the Standard Event Status Register when the long process finishes. See the *ESR documentation on page 101 for a description of this register.

Name: *WAI – Wait to continue.
Description: This command is implemented for compatibility with the IEEE-488 standard. The original intent was for *WAI to prevent the instrument from executing commands until it completed all pending operations.

*WAI

Name: `verbmd(?)` – Set or query the instrument’s verbosity.

Description: This command sets or queries the instrument’s verbosity using the mapping below. In terse mode, the instrument will issue no unsolicited output – such as error messages. This mode suits automated equipment that can not handle unexpected inputs. In verbose mode, the instrument will issue warning and error messages as needed.

`verbmd(?) {i}`

i	Mode
0	Terse mode
1	Verbose mode

Name: `lockfp(?)` – Set or query front panel lockout.

Description: The front panel keypad can be disabled to prevent inadvertent adjustments.

`lockfp(?) {i}`

i	Mode
0	Front panel unlocked – normal operation
1	Front panel disabled

All buttons except [LOCAL] will be disabled after sending `lockfp 1`. Pressing [LOCAL] will unlock the front panel and reset `lockfp` to 0.

Name: `ifcclr` – Reset the remote interface.

Description: This command clears the remote interface’s transmit and receive queues. If the instrument’s reply to a query isn’t read before another query is issued, an error occurs and new reads are forbidden. Sending `ifcclr` when this happens will clear this condition, allowing new queries to be sent and their replies to be read.

`ifcclr`

The REF bit in the instrument status register described on page 103 is set when multiple queries are sent without a read. Sending `ifcclr` will not clear this bit – it should be cleared with a normal `INSR?` query.

Name: `macadr?` – return the EC301’s Media Access Control (MAC) address.

Description: This query only command takes no arguments and returns the MAC address.

`macadr?`

Name: vfdmsg – Display a string on the character display.

Description: This set-only command prints the input string argument to either the first or second line of the front panel vacuum fluorescent character display. The string must be less than 24 characters long, and may not contain any spaces, tabs, or other whitespace characters.

vfdmsg{i}{string}

i	Display line
0	Top line
1	Bottom line

For example, the command

```
vfdmsg 0 string_to_display
```

will print STRING_TO_DISPLAY on the top line of the character display.

Name: nulcmd – Do absolutely nothing.

Description: This command is useful for testing the remote interface without doing any harm. Sending the nulcmd? query will always return 0.

nulcmd(?) {i}

Example:

```
nulcmd? Does nothing but write 0 to the transmit queue.
0
```

8.3.14 Timebase commands

Name: `exttmb` – Query the timebase.

Description: This query-only command returns the state of the sampling timebase.

`exttmb?{i}`

i	Timebase setting
0	Internally generated (no external timebase present)
1	Externally generated (external timebase automatically selected when present)
2	Internally generated (external timebase present, but disabled via the <code>autotb</code> command described on this page).

Name: `autotb` – Turn automatic timebase selection on or off.

Description: This set-only command turns automatic timebase selection on or off. Use the `exttmb?` query described above to query the timebase selection state.

`autotb{i}`

i	Setting
0	Manual mode – timebase generated internally even though an external timebase is present.
1	Automatic mode – timebase generated internally by default, but accepted from external source if present.

8.3.15 Status reporting commands

Name: *ESR? – Query the Standard Event Status register.

Description: This command returns values from the Standard Event Status register. Sending *ESR? will return the entire register value in decimal format, while sending *ESR? *i* will only return bit *i*. Reading the register will also clear it. Sending *ESR? will clear the entire register, while sending *ESR? *i* will only clear bit *i*. Table 6 below lists the conditions corresponding to the register bits. Use the *ESE register described on the following page to enable these bits to set a bit in the Status Byte. See figure 34 on page 110 for an overview of status bit promotion.

*ESR?{*i*}

Bit	Name	Set when...
0	OPC	The *OPC command has completed.
1	Unused	
2	QYE	Query error – data has been lost instead of transmitted.
3	DDE	Device specific error – an error was encountered while executing a remote command.
4	EXE	Execution error – a remote command could not be executed due to an argument or state problem.
5	CME	Command error – an invalid remote command was received.
6	URQ	User request – front panel activity was attempted regardless of local/remote status.
7	PON	The unit has turned on.

Table 6: The Standard Event Status register bits.

The Standard Event Status register is defined by the IEEE-488.2 (1987) standard, and is used primarily to report errors in commands received over the remote interface. These bits remain set until read, cleared by the *CLS command, or until the unit is turned on with *PSC enabled.

Example:

*ESR? Returns the Standard Event Status register value (0→255)
*ESR? 5 Returns 0 if bit 5 (CME) is cleared, or 1 if it is set.

Name: *ESE(?) – set or query bits in the Standard Event Enable register.

Description: The *ESE i command sets the Standard Event Enable register to the decimal value i (0 → 255). The *ESE i,j command sets bit i (0 → 7) to j (0 or 1). As shown in figure 34, bits enabled in the *ESR register via the *ESE register set the ESB bit in the status byte.

The *ESE? query returns the value (0 → 255) of the Standard Event Enable Register. The *ESE? i command queries the value (0 or 1) of bit i (0 → 7).

*ESE(?) {i} {,j}

When the instrument sets a bit in the Standard Event Status Register (*ESR, described on the previous page), and the corresponding bit is set in the Standard Event Enable Register (this one) by the user, bit 5 (ESB) of the Status Byte (*STB, described on page 107) is set. This causes a SRQ if bit 5 in the Status Byte is set.

Example:

*ESE? *Returns the register value in decimal format*
 *ESE? 2 *Returns 0 if bit 2 is cleared, or 1 if it is set*
 *ESE 48 *Sets the register value to 48 (bits 4 and 5 set)*
 *ESE 7,0 *Clears bit 7*

Name: INSR? – Query the Instrument Status Register.

Description: This command returns values from the Instrument Status Register. Sending INSR? will return the entire register value in decimal format, while sending INSR? *i* will only return bit *i*. Reading the register will also clear it. Sending ISNR? will clear the entire register, while sending INSR? *i* will only clear bit *i*. Table 7 lists the conditions corresponding to the register bits. See figure 34 on page 110 to see an overview of all status registers.

INSR?{*i*}

Bit	Name	Set when...
0	STF	Selftest Failure – the selftest has failed.
1	KPE	Keypress Event – a key was pressed on the front panel in local mode.
2	KRO	Knob Rotation – a parameter was changed by rotating the knob in local mode.
3	RES	Remote Set – a remote set command (not a query) was issued
4	CRC	Current Range Change – there was a change in the current (I) range.
5-11		Internal use.
12	ETA	External Timebase Acquired – achieved lock to 10MHz timebase.
13	ETL	External Timebase Lost – lost lock to 10MHz timebase.
14	ERR	An error has been posted that can be queried with <code>errlst?</code> .
15	REF	Query Refused - a previous query has not been completely read. Perform read or send <code>ifcclr</code>

Table 7: The Instrument Status register bits.

Example:

INSR? <i>Returns the Instrument Status register value (0→65535)</i>
INSR? 4 <i>Returns 0 if bit 4 (CRC) is cleared, or 1 if it is set.</i>

Name: INSE(?) – set or query bits in the Instrument Status Enable Register.

Description: The INSE *i* command sets the Instrument Status Enable register to the decimal value *i* (0 → 65535). The INSE *i*, *j* command sets bit *i* (0 → 15) to *j* (0 or 1). As shown in figure 34 on page 110, bits enabled in the INSR register (defined on the preceding page) via the INSE register (this one) set the INSW bit in the status byte.

The INSE? query returns the value of the Instrument Status Enable register. The INSE? *i* command queries only bit *i*.

INSE(?)*{i}{,j}*

When the instrument sets a bit in the Instrument Status Register, and the corresponding bit is set in the Instrument Status Enable register by the user, bit 1 (INSW) of the Status Byte is set. This causes a SRQ if bit 0 in the Status Byte Enable register is set.

Example:

INSE? *Returns the register value in decimal format*
 INSE? 2 *Returns 0 if bit 2 is cleared, or 1 if it is set*
 INSE 16 *Sets the register value to 16 (bit 4 set)*
 INSE 4,0 *Clears bit 4*

Name: MESR? – Query the Measurement Status register.

Description: This command returns values from the Measurement Status register. Sending MESR? will return the entire register value in decimal format, while sending MESR? i will only return bit i. Reading the register will also clear it. Sending MESR? will clear the entire register, while sending MESR? i will only clear bit i. Table 8 lists the conditions corresponding to the register bits.

MESR?{i}

Bit	Name	Set when...
0	CEL	CE limit – The CE voltage limit (either $\pm 30V$ or the user-defined limit) was reached.
1	EOL	E overload – the E measurement exceeded $\pm 15V$.
2	IOL	I overload – the I measurement exceeded 200% of a range or 1A.
3	A01	Auxiliary ADC channel 1 overload – the BNC input exceeded $\pm 10V$.
4	A02	Auxiliary ADC channel 2 overload – the BNC input exceeded $\pm 10V$.
5	A03	Auxiliary ADC channel 3 overload – the BNC input exceeded $\pm 10V$.
6	NRH	No remote amplifier (EC19) detected
7	CIL	CE limit – The CE current limit ($\pm 1A$) was reached.

Table 8: The Measurement Status register bits.

Example:

MESR? Returns the Instrument Status register value (0→65535)
MESR? 4 Returns 0 if bit 4 (CRC) is cleared, or 1 if it is set.

Name: MESE(?) – set or query bits in the Measurement Status Enable Register.

Description: The MESE *i* command sets the Measurement Status Enable register to the decimal value *i* (0 → 65535). The MESE *i*, *j* command sets bit *i* (0 → 15) to *j* (0 or 1). As shown in figure 34 on page 110, bits enabled in the MESR register (defined on the preceding page) via the MESE register (this one) set the MESW bit in the status byte.

The MESE? query returns the value of the Measurement Status Enable Register. The MESE? *i* command queries only bit *i*.

MESE(?)*{i}{,j}*

When the instrument sets a bit in the Measurement Status Register, and the corresponding bit is set in the Measurement Status Enable register by the user, bit 1 (MESW) of the Status Byte is set. This causes a SRQ if bit 1 in the Status Byte Enable register is set.

Example:

MESE? *Returns the register value in decimal format*
 MESE? 2 *Returns 0 if bit 2 is cleared, or 1 if it is set*
 MESE 48 *Sets the register value to 48 (bits 4 and 5 set)*
 MESE 7,0 *Clears bit 7*

Name: *STB? – Query Status Byte values.

Description: This command returns values from the Status Byte register. Sending *STB? will return the entire register value in decimal format, while sending *STB? i will only return bit i. Reading this register will not clear it – it must be cleared by reading the registers that feed it. See figure 34 on page 110 for a description of how status bit values are promoted to this register. Table 9 lists the conditions corresponding to the register bits.

*STB?{i}

Bit	Name	Set when...
0	INSW	An unmasked bit in the Instrument Status Register (described on page 103) has been set.
1	MESW	An unmasked bit in the Measurement Status Register (described on page 105) has been set.
2		Not used.
3		Not used.
4	MAV	There is a message available in the GPIB queue.
5	ESB	An unmasked bit in the Standard Event Status Register (described on page 101) has been set.
6	SRQ	Service request. See the *SRE command described on the next page for more information.
7	IFC	Set when the remote interface's receive queue is full.

Table 9: The Status Byte Register bits.

Name: *SRE(?) – set or query bits in the Status Byte Enable register.

Description: The *SRE i command sets the Status Byte Enable register to the decimal value i (0 → 255). The *SRE i, j command sets bit i (0 → 7) to j (0 or 1). As shown in figure 34 on page 110, bits enabled in the *STB register via the *SRE register set the SRQ bit.

The *SRE? query returns the value (0 → 255) of the Standard Event Enable Register. The *SRE? i command queries the value (0 or 1) of bit i (0 → 7).

When the instrument sets a bit in the Status Byte register, and the corresponding bit is set in the Status Byte Enable register by the user, bit 6 (SRQ) of the Status Byte is set. The front panel SRQ light described in section 3.1.17 on page 35 will also light up. This can be used as a general purpose indicator for a condition described by the status bits. The example below describes using SRQ to indicate an overload at the rear panel auxiliary ADC input BNC.

*SRE(?) {i} {, j}

Example:

*SRE 2 *Unmask the MESR status bits only*
 MESE 8 *Unmask the “Aux 1 overload” status bit from MESR*
Apply more than 10V to the rear panel Aux 1 BNC to cause a SRQ
 *STB? *See that bit 6 (SRQ) of the status byte has been set*
Remove the overload on Aux 1
 MESR? *Query the MESR register to clear the “Aux 1 overload” bit*
 *STB? *See that bit 6 (SRQ) has also been cleared in the status byte*

*CLS

Name: *CLS – clear all status registers.

Description: This command clears all the status registers (INSR, MESR, and *ESR). It will also terminate all scans in progress.

Name: errmsg? – Return the front panel’s most recent error code or message.

Description: This query-only command returns errors that have been displayed on the front panel character display. Since these errors disappear after a short time, this command provides a way to always get the most recent error message.

errmsg? {i}

The error codes returned with i = 0 are unique to errmsg? – the front panel errors. They can not be decoded using errdcd?. See the errlst? and errdcd? commands on pages 109 and 109 for more information about error reporting.

i	Error report returned
0	Most recent error code
1	Most recent error message
2	Verbose form of most recent error message

Name: `errlst?` – Return the most recent system-level error code.

Description: This query-only command returns the code corresponding to the most recent system-level error. While the `errmsg?` command described on page 108 deals with error messages visible on the front panel, this query deals with errors output via the remote interface. Error codes are decoded with the `errdcd?` query described on this page.

These errors are cleared by either a front panel button press or a set command.

`errlst?`

Example:

```
badcmd badcmd isn't a known command
errlst? Query the most recent error
114 The error code is 114
errdcd? 114 Let's see what error code 114 is
Bad remote command Yes, that makes sense
irange 5 Use a set command to clear the error
errlst?
0 The error has been cleared
```

`errdcd?{i}`

Name: `errdcd?` – Decode the error code from `errlst?`.

Description: This query-only command returns the description of the error code reported by `errlst?`. See the `errlst?` query description on the current page for more information.

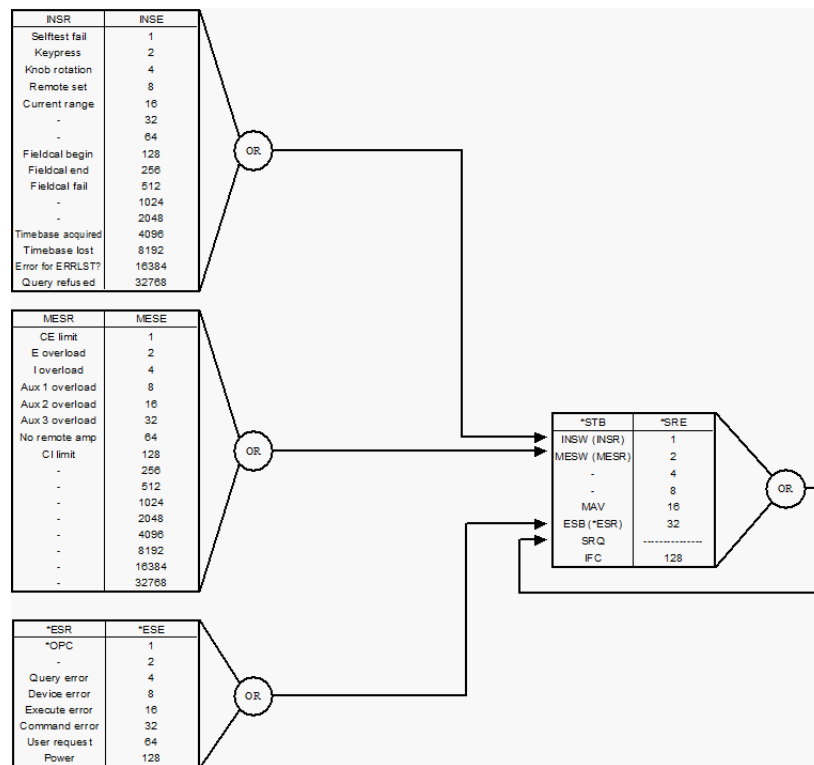

Figure 34: The status bit promotion diagram. Enabling bits in the INSR, MESR, and *ESR status registers allows them to set bits in the *STB. Enable these bits with the INSE, MESE, and *ESE registers. Properly configuring status bit promotion allows quick status byte (*STB) queries to indicate problems.

8.3.16 Pulsed waveform generation commands

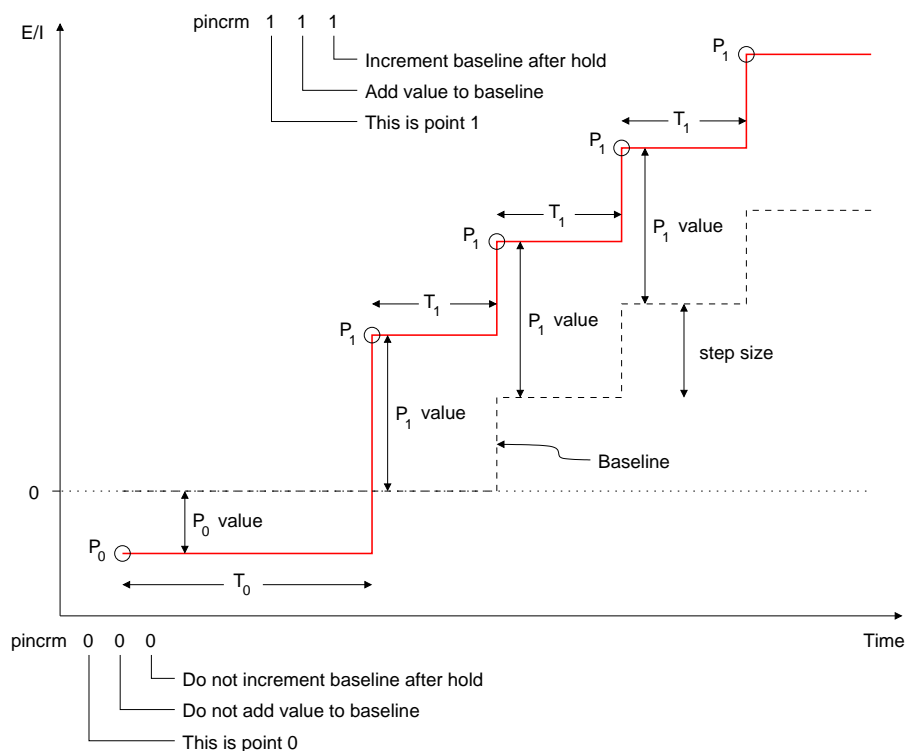

Figure 35: A very basic waveform illustrating the pulsed waveform construction parameters.

Name: `ppoint(?)` – Set or query the number of pulse waveform points.

Description: Pulsed waveforms may be specified with up to six control points, with the number of points given by $i + 1$. The waveform generator must be told how many points it will be using.

Parameter	Allowed values
i	1,2,3,4,5, ..., 15

`ppoint(?) {i}`

Figure 35 illustrates a waveform with only two control points. The first point, P_0 , allows the cell to be held at a constant potential or current before the repetitive part of the waveform is applied. Subsequent points are then output until the `ppoint` value is reached. The waveform then loops back to output point P_1 .

For example, the command

```
ppoint 1
```

will tell the waveform generator to make room for the minimum number of two control points.

Name: `psteps(?)` – Set or query the pulsed waveform step size.

Description: This is the current or potential increment applied to the pulsed waveform baseline.

Parameter	Mode	Units	Range
x	Potentiostat	mV	-15000, -14999, -14998, ..., +15000
	Galvanostat	$\frac{I_{\text{range}}}{1000}$	$\frac{-2000, -1999, -1998, \dots, +2000^1}{-1-1000 \rightarrow +1000 \text{ for 1A range}}$

`psteps(?) {x}`

This step size takes mV values in potentiostat mode, and milli-fractions of the full scale current (I_{range}) in galvanostat mode. As illustrated in figure 35, the baseline is incremented after a control point is applied with its increment bit set (`pincrm x x 1`).

For example, the command

```
psteps 50
```

sets the step size to 50mV.

Name: `pdatap(?)` – Set or query the pulse data waveform control point values.

Description: Each of the possible six control points used to specify a pulsed waveform needs a voltage or current “value.”

Parameter	Range
i	0, 1, 2, ..., 5

Parameter	Mode	Units	Range
x	Potentiostat	mV	-15000, -14999, -14998, ..., +15000
	Galvanostat	$\frac{I_{\text{range}}}{1000}$	$\frac{-2000, -1999, -1998, \dots, +2000^1}{-1-1000 \rightarrow +1000 \text{ for 1A range}}$

`pdatap(?) {i} {x}`

The `i` parameter chooses the control point to set or query. The point values take mV values in potentiostat mode, and milli-fractions of the full scale current (I_{range}) in galvanostat mode. As illustrated in figure 36, these values can be added to the baseline to form the finished waveform.

For example, the command

```
pdatap 0 1000
```

sets the value of P_0 to 1V in potentiostat mode, or I_{range} in galvanostat mode.

Name: pholdt(?) – Set or query the pulse data waveform control point hold times.

Description: Each of the possible six control points used to specify a pulsed waveform needs a hold time.

Parameter	Range
i	0, 1, 2, \dots , 5

pholdt(?) {i} {x}

Parameter	Units	Range
x	4 μ s	1, 2, 3, \dots , 16777215 ($2^{24} - 1$)

The i parameter chooses the control point to set or query. Figure 36 shows hold times T_0 and T_1 for points P_0 and P_1 .

For example, the command

```
pholdt 0 2000
```

sets the T_0 hold time to 8ms.

Name: `pincrm(?)` – Configure how a pulsed waveform point interacts with the baseline.

Description: Each control point in the pulsed waveform can either add its value to the baseline or to 0V/0A to form the finished waveform. The points (all except P_0) can also instruct the baseline to increment when their hold times have expired.

Parameter	Range
i	1, 2, 3, 4, 5

j	Mode
0	Do not add this point's value to the baseline
1	Add this point's value to the baseline

k	Mode
0	Increment baseline after the point's hold has expired
1	Leave baseline unchanged after this point

`pincrm(?){i}{j}{k}`

The *i* parameter chooses the control point to set or query. The *j* parameter selects whether or not the selected control point's value (set with `pdatap`) will add to the baseline in the final waveform. The *k* parameter selects whether or not the baseline should be incremented after the point's hold has ended.

For example, the P_1 point shown in figure 35 is configured with the command

```
pincrm 1 1 1
```

to have its value added to the baseline, and for the baseline to increment after the T_1 hold has expired.



The first P_0 point in a pulsed waveform definition is unique. It allows a non-repeating hold to be applied to the cell before a pulsed waveform train is applied. `pincrm` bits set for this point will be ignored, and queries will always return 0 0 0

Name: `plimit(?)` – Set or query the number of steps in a pulsed waveform.

Description: This command sets the number of steps the baseline will make in a pulsed waveform.

`plimit(?) {x}`

Parameter	Range
x	1, 2, 3, ..., 1048575 ($2^{20} - 1$)

For example, the waveform shown in figure 35 shows four steps. The command

```
plimit 4
```

would make the pulsed waveform either stop or turn around depending on the `plendm` command.

Name: `plendm(?)` – Set or query the pulsed waveform end mode.

Description: The pulsed waveform can either run in one direction and stop, or continuously scan between two endpoints.

`plendm(?) {i}`

i	Mode
0	Baseline increment reverses every <code>plimit</code> steps
1	Baseline will increment <code>plimit</code> steps and stop

Name: `plinit` – Initialize the pulsed waveform.

Description: This command must be sent before a pulsed waveform can be output. See the example pulsed waveform example in section 8.4.1 on page 129 for more information.

`plinit`

Name: `pprogm?` – Verify the pulse program has no missing points.

Description: This query must be sent before beginning a pulse waveform with the `pstart` command. It verifies that there are no missing data points for the pulse program. If one or more points are missing, `pprogm?` returns an error code (see table below).

If no points are missing, `pprogm?` returns zero.

The `pprogm?` error code is a bit field defined as follows:

`pprogm?`

n	2 ⁿ	Issue
0	1	One or more unique points has no data
1	2	reserved
2	4	reserved
3	8	reserved
4	16	reserved
5	32	reserved
6	64	reserved
7	128	reserved

Name: `pstart` – Start the pulsed waveform.
Description: Sending this command will close the control loop and run the programmed pulsed waveform.

Name: `plstop` – Stop the pulsed waveform.
Description: This command halts the pulsed waveform, leaving the control loop closed.

8.3.17 Ramp generation commands

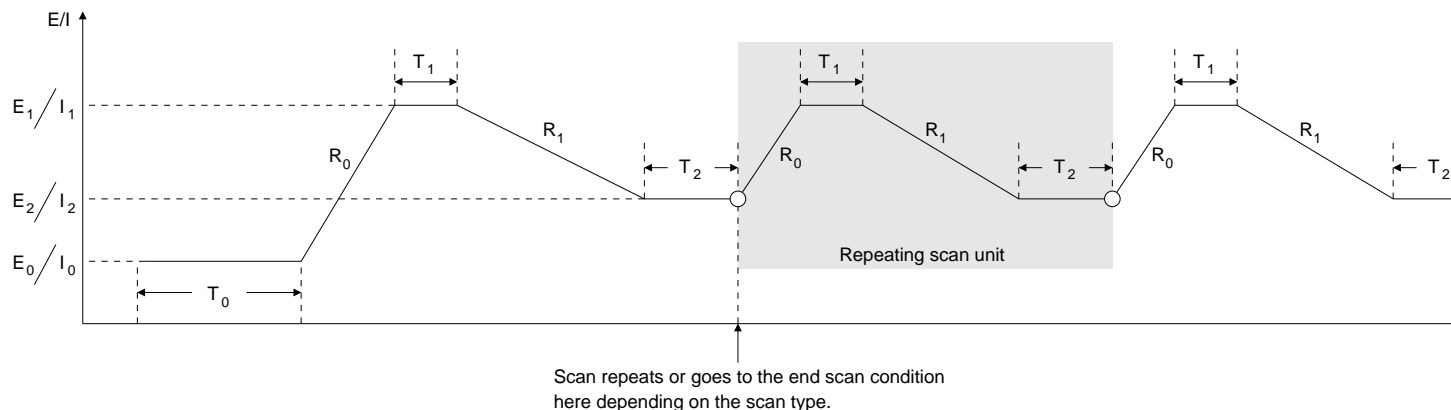

Figure 36: Parameters needed for the ramp generation commands.

Name: `ramppt(?)` – Set an E or I vertex point for the ramp.

Description: As illustrated in figure 36, there are three E/I vertex points needed to define a ramp waveform.

i	Vertex point
0	E_0/I_0
1	E_1/I_1
2	E_2/I_2

Parameter	Mode	Units	Range
<code>ramppt(?) {i} {x}</code>	Potentiostat	mV	$-15000, -14999, -14998, \dots, +15000$
	Galvanostat	$\frac{I_{\text{range}}}{1000}$	$\frac{-2000, -1999, -1998, \dots, +2000^1}{^1-1000 \rightarrow +1000 \text{ for 1A range}}$

These vertex points take mV values in potentiostat mode, and milli-fractions of the full scale current (I_{range}) in galvanostat mode.

For example, the command

```
ramppt 0 -500
```

sets the first ramp vertex to -500mV (potentiostat mode) or 500 thousandths of I_{range} (galvanostat mode). The command

```
ramppt? 0
-500
```

will return the value loaded into index 0.

Name: `ramprt(?)` – Set or query a ramp rate for the ramp waveform.

Description: As illustrated in figure 36, there are two ramp rates needed to define a ramp waveform.

i	Ramp rate
0	R_0
1	R_1

Parameter	Mode	Units	Range
x	Potentiostat	100 μ V/s	1, 2, 3, \dots , 1×10^8
	Galvanostat	$\frac{I_{\text{range}}}{1000 \cdot \text{s}}$	1, 2, 3, \dots , 2000

`ramprt(?) {i} {x}`

These rates take multiples of 100 μ V/s in potentiostat mode, and milli-fractions of the full scale current (I_{range}) per second in galvanostat mode. They are always entered as positive numbers. The actual scan direction (sign of the rate) will be determined by the relative magnitudes of the vertices set with `ramprt`.

Maximum current on the 1 A range is 1 A, but it is fine to scan at 2 A/s. There is no special restriction for scan rate on the 1 A range.

For example, the command

```
ramprt 0 1000
```

sets the R_0 ramp rate to 100mV/s (potentiostat mode) or $\frac{I_{\text{range}}}{10 \cdot \text{s}}$ in galvanostat mode. The command

```
ramprt? 0
1000
```

will return the value loaded into index 0.

Name: `rampdt(?)` – Set or query a delay time for the ramp.

Description: As illustrated in figure 36, there are three delay times needed to define a ramp waveform.

i	Delay time
0	T_0
1	T_1
2	T_2

`rampdt(?) {i} {x}`

Parameter	Units	Range
x	100 μ s	0, 1, 2, \dots , 4294967295 ($2^{32} - 1$)

For example, the command

```
rampdt 0 10000
```

will set T_0 to 1s. The command

```
rampdt? 0
10000
```

returns the value loaded into index 0.

`ramprs`

Name: `ramprs` – Reset the ramp program.

Description: This command clears the previous ramp program. It must be sent before a new ramp waveform is programmed. Sending `ramprs` will stop any running ramp waveforms. Use `rampst` instead to simply stop the waveform without clearing the program.

Name: `ramppg?{x}` – Verify the ramp program parameters for ramp type {x}.

Description: This query must be sent before beginning a ramp with the `rampst` command. It verifies that the parameters necessary for the given ramp type {x} are specified. If one or more of the parameters are missing, `ramppg?{x}` returns an error code (see table below). If no parameters are missing, `ramppg?{x}` returns zero.

`ramppg?{x}` has the following valid argument range for {x}:

`ramppg?`

{x}	Check parameters for this waveform type
0	Cyclic Voltammetry
1	Linear Sweep Voltammetry
2	Infinite Hold
3	Timed Hold
4	Arm Linear Sweep Voltammetry

The `ramppg?{x}` error code is a bit field defined as follows:

n	2^n	Missing parameter
0	1	T1
1	2	T2
2	4	P1
3	8	P2
4	16	P3
5	32	R1
6	64	R2
7	128	reserved

Name: `rampst` – Start a ramp or hold.

Description: Sending this command will close the control loop (if necessary) and run the programmed ramp waveform. Use `rampst 4` or `rampst 5` for scans triggered with the rear panel `SCAN TRIGGER` input.

`rampst{i}`

i	Mode
0	Begin a CV ramp
1	Begin an LSV ramp
2	Begin an infinite hold
3	Begin a timed hold
4	Arm in preparation for a CV ramp
5	Arm in preparation for an LSV ramp

`rampen{x}`**Name:** `rampen` – End the ramp in progress.**Description:** This command will end a running ramp waveform without clearing the program.`rampcy(?) {x}`**Name:** `rampcy(?)` – Set or query the number of ramp cycles.**Description:** The “repeating scan unit” illustrated in figure 36 can be repeated a few times or forever. Use this command to set a finite number of repeats after disabling single scanning with `scantp 0`.

Parameter	Range
<code>x</code>	1, 2, 3, \dots , 254

Note that sending `rampcy 1` will still set the E_2/I_2 vertex twice, since the repeating scan unit will be run once. Send `scantp 1` to set the single scan type for just one scan.

`scantp(?) {i}`**Name:** `scantp(?)` – Set or query the scan type.**Description:** This command enables or disables single scanning.

i	Mode
0	Continuous scanning
1	Single scan

A single scan sets the end scan condition after waiting the first T_2 delay shown in figure 36. If this is disabled, the scan will continue and repeat the “repeating scan unit.” The number of repetitions is infinite by default, but can be made finite by sending a value for `rampcy`.

`scanem(?) {i}`**Name:** `scanem(?)` – Set or query the scan end condition.**Description:** Single scans can either return the cell to open-circuit or to the E_0/I_0 vertex shown in figure 36.

i	Scan end condition
0	Open circuit
1	Hold at E_0/I_0

8.3.18 Arbitrary waveform generation commands

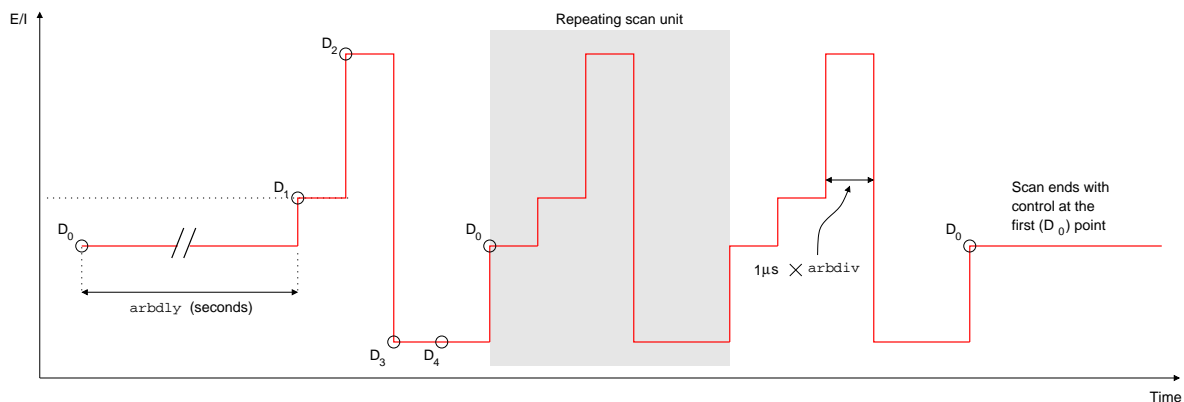

Figure 37: Illustration of an arbitrary waveform with five `arbset` points and three repetition cycles. The time between `ARBSET` points is always $1\mu\text{s} \times \text{arbddiv}$. Repeat points to get longer hold times.

Name: `arbrst` – Reset the arbitrary waveform generator.

Description: The arbitrary waveform generator should be reset before a new waveform is programmed. This reset disables the generator and sets the default conditions listed in table 10.

`arbrst`

Parameter	Set with...	Default value	Notes
Waveform type	<code>arbtyp</code>	Undefined	A waveform type must be chosen with <code>arbtyp</code> before points can be entered with <code>arbset</code> .
Number of points	<code>arbpts</code>	0	
Start delay	<code>arbdly</code>	0	
Clock divider	<code>arbddiv</code>	1	
Number of cycles	<code>arbcyc</code>	1	
End condition	<code>arbend</code>	E_1/I_1	By default, the instrument will loop back to hold the first point in the waveform when the scan ends.
Scan trigger	<code>arbrun</code>	Internal	By default, triggering via the <code>SCAN TRIGGER</code> input is disabled.

Table 10: Arbitrary waveform generator parameters after issuing the `arbrst` command.

Name: `arbpts?` – Query the number of points in the arbitrary waveform.
Description: This query-only command returns the number of points that have been set via the `arbset` command. It may be used to verify that all `arbset` commands were processed properly.

`arbpts?`

Returned parameter	Values
Programmed points	0,1,2,⋯,1599

Name: `arbdly(?)` – Set or query the hold time for the first arbitrary waveform point.
Description: The EC301 can hold the first point in an arbitrary waveform to let a cell settle. This command sets the “extra” time that the point should be held relative to the following points.

`arbdly(?) {i}`

Parameter	Units	Range
i	seconds	0, 1, 2, ⋯, 1023

Name: `arbdiv(?)` – Set or query the playback rate divider for the arbitrary waveform generator.
Description: The default playback rate for arbitrary waveform points is 1 megasample per second. This command allows reducing that rate by a factor of i.

`arbdiv(?) {i}`

Parameter	Units	Range
i	None	1, 2, 3, ⋯, 1024

For example, the sequence

```
arbdiv 1000
arbdiv?
1000
```

will set the playback rate to $\frac{1\text{Msps}}{1000} = 1\text{ksps}$, or 1000 points per second.

Name: `arbend(?)` – Set or query the end condition for arbitrary waveform scans.
Description: Arbitrary waveform scans can end by either maintaining control at the first point of the waveform, or by releasing control (open circuit).

`arbend(?) {i}`

i	Mode
0	Control is maintained at the first waveform point (default)
1	Control is released (open circuit)

Name: `arbcyc(?)` – Set or query the number of repetitions for arbitrary waveform scans.

Description: Arbitrary waveform scans can be set to repeat either a finite or infinite number of times.

`arbcyc(?) {i}`

i	Mode
0	Repeat an infinite number of times. The user can end the infinite loop by sending <code>arbrun 0</code> .
1, 2, 3, ..., 1024	Repeat <i>i</i> number of times. The scan will end in the condition set by <code>arbend</code> .

Name: `arbset?` – Set an arbitrary waveform datum.

Description: This command programs arbitrary waveform data on a point-by-point basis. Each point is specified by an index (*i*) and a datum (*j*). Waveform points are played beginning with *i*=0, and up to 16,000 points can define the waveform.

The datum type is set by `arbtyp`. Potentiostatic datum types have units of mV, while galvanostatic types have milli- I_{range} units. For example, if the datum type is 5 – corresponding to galvanostat mode in the 1mA range – the datum will have units of μA .

`arbset? {i} {j}`

Parameter	Range
<i>i</i>	0, 1, 2, ..., 1599

Parameter	Type	Range	Units
<i>j</i>	Potentiostat	-15000, -14999, -14998, ..., +15000	mV
	Galvanostat (1 A range)	-1000, -999, -998, ..., +1000	$\frac{I_{\text{range}}}{1000}$
	Galvanostat (all others)	-2000, -1999, -1998, ..., +2000	$\frac{I_{\text{range}}}{1000}$



Each `arbset?` produces an error code reply from the EC301. If the reply to `arbset?` is non-zero, it signifies an error. Every `arbset?` must be followed by reading the error code reply from the EC301

Name: `arbget` – Query the value of the arbitrary waveform at index `{i}`.

`arbget?{i}`

Description: To determine what value is programmed at any index, use `arbget?` If no value is programmed at the given index `{i}`, `arbget?` returns an error code, 31.

Name: `arbtyp(?)` – Set or query the arbitrary waveform type.

Description: The user must set the arbitrary waveform type with `arbtype` before entering data points with `arbset`. The `arbtype` command argument defines the legal range of `arbset` arguments. This waveform type can only be defined once. This prevents mixing control point data types in memory. This also means that the `arbrst` command must be sent between `arbtyp` commands.

`arbtyp(?) {i}`

i	Scan type	Range
0	Potentiostatic	±15V
1	Galvanostatic	1A
2		100mA
3		10mA
4		1mA
5		100µA
6		10µA
7		1µA
8		100nA
9		10nA
10		1nA
11	Boosted galvanostatic	2.5A
12		5A
13		10A

Notice that there is a scan type for each current range. Arbitrary waveform points for galvanostat scan types are simply fractions of the full scale current, so there must be a way to define this current. After setting a galvanostatic scan type, sending `arbrun 1` or `arbrun 2` will force the instrument into the range defined by the scan type.

Under boosted operation, the only valid `arbtyp` argument is the index associated with the installed booster. For example, if you are using the 20V/20A booster the only valid argument to `arbtyp` is 13. If you switch from boosted operation to normal operation, the valid argument range for `arbtyp` becomes 1-10.

Name: `arbrun` – Begin, end, or arm arbitrary waveform playback.

Description: This set-only command allows for either internal or external triggering of arbitrary waveform scans.

`arbrun{i}`

i	Instruction
0	Stop waveform playback and open the control loop. This will also disarm the scan to ignore <code>SCAN TRIGGER</code> inputs.
1	Start waveform playback automatically. This will engage the control loop in whichever mode/range combination specified with <code>arbtyp</code> .
2	Arm waveform playback. This will engage the control loop in whichever mode/range combination specified with <code>arbtype</code> , but playback will not begin until a falling edge is received at the rear panel <code>SCAN TRIGGER</code> input.

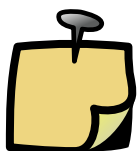

Only one scan type (ramp, pulse, hold, or arbitrary) can be “armed” at any one time. The most recent scan type to be armed will be run when a trigger is received at `SCAN TRIGGER`.

8.3.19 Reading temperature measurements

Name: anyrtd? – Query whether an RTD probe is installed.
Description: This query-only command returns 1 if an RTD temperature sensor is available, 0 if not.
Example:

anyrtd?

```
anyrtd?  
1 RTD installed
```

Name: getrtd? – get temperature reading.
Description: This query-only command returns the RTD probe measurement in °C.

getrtd?

Example:

```
getrtd?  
52.75 Degrees Celsius
```

Name: rtdohm? – get the RTD probe resistance.
Description: This query-only command returns the RTD probe resistance in ohms.

rtdohm?

Example:

```
rtdohm?  
50.35 Ohms
```

8.3.20 Booster operation commands

Name: `bstrty?` – Query the booster type (if any).

Description: This query-only command returns an integer indicating the external booster type that was calibrated with this EC301.

`bstrty?`

Returned parameter	Booster
0	None
1	BOP 20V-5A
2	BOP 20V-10A
3	BOP 20V-20A

Name: `bstren(?)` – booster enable.

Description: The booster enable query returns 1 under boosted operation, 0 under normal operation. The user can send `bstren i` to set the instrument to boosted ($i=1$) or normal ($i=0$) operation.

`bstren(?) {i}`



The cable configuration **must** change between boosted and normal operation. Under normal (not boosted) operation, the EC19 leads from the CE and WE jacks should be connected to the load. Under boosted operation, the CE and WE leads **should not** be connected—the terminal leads from the booster should be used instead. Under most circumstances, SRS recommends using the front panel interface for enabling or disabling booster operation. The `bstren` remote command is provided to allow returning to boosted operation after sending the `*RST` command. `*RST` returns the instrument to its default state (including normal, non-boosted operation). Send `bstren 1` to return the instrument to boosted operation.

Also note that sending the set command while the control loop is closed will generate an error and not affect the instrument's state. Open the control loop with the command `CEENAB 0` before sending `BSTREN 0` or `BSTREN 1`.

8.4 Programming examples

8.4.1 Normal pulse

As described by Bard and Faulkner [1], the normal pulse voltammetry waveform involves a base potential and a series of increasing steps. The following command sequence produces the waveform shown in figure 38. *Slanted text* following a command is only used to clarify the example, and would be rejected by the EC301.

```

PLINIT Initialize the waveform generator
PPOINT 2 The waveform will have 3 control points
PSTEPS 200 Baseline potential will increment in +200mV steps
PLIMIT 4 Baseline will increment 4 times
PDATAP 0 100 The zeroth point is at +100mV
PHOLDT 0 500000 The zeroth point is held for 2s
PDATAP 1 400 The first point amplitude is +400mV
PHOLDT 1 62500 The first point is held for 250ms
PINCRM 1 1 1 The first point is added to the baseline
PDATAP 2 100 The second point amplitude is +100mV
PHOLDT 2 250000 The second point is held for 1s
PINCRM 2 0 0 The second point is not added to the baseline, and is the last point
PLENDM 1 Set the scan to end after the set number of increments
PPROGM? Load the pulse program, verify parameters
PSTART Start the scan

```

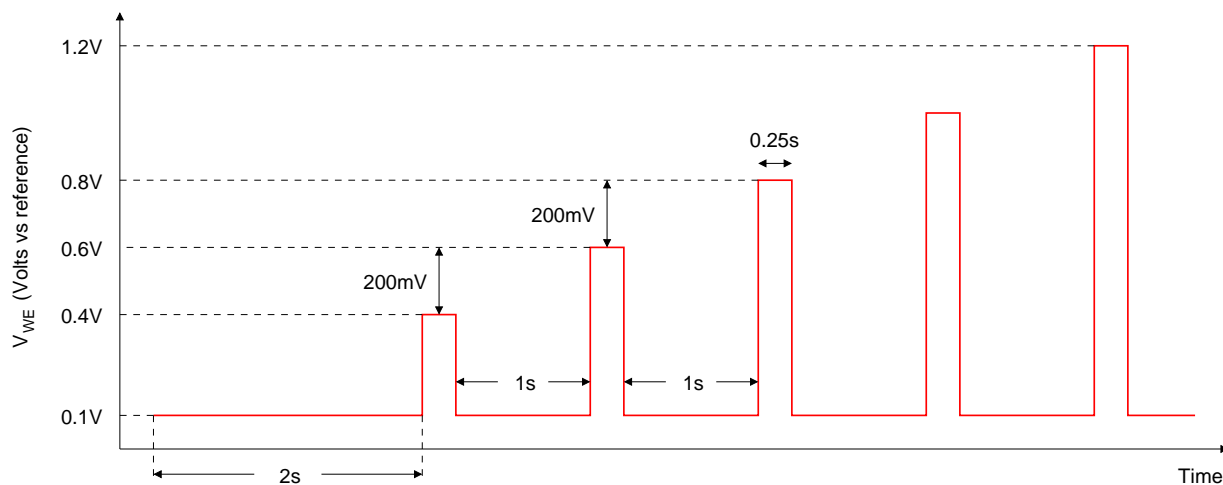

Figure 38: Sample normal pulse waveform.

8.4.2 Cyclic voltammetry

The cyclic voltammetry waveform includes a hold and a ramp reversed at a switching potential. The following command sequence produces the waveform shown in figure 39. Refer to figure 36 on page 117 for definitions of the potential, delay, and rate point indexes.

```

RAMPRS Initialize the ramp generator
SCANTP 1 Set single (not continuous) scan type
SCANEM 1 Set the scan endpoint to E0
RAMPPT 0 100 Set the E0 point at +100mV
RAMPDT 0 60000 Set the T0 delay time to 6s
RAMPRT 0 2000 Set the R0 ramp rate to 0.2V/s
RAMPPT 1 500 Set the E1 point at +500mV
RAMPDT 1 0 No delay at the E1 point
RAMPRT 1 2000 Set the R1 ramp rate to 0.2V/s
RAMPPT 2 100 Set the E2 point at +100mV
RAMP PG? 0 Load the ramp program, verify parameters
RAMPST 0 Start the scan

```

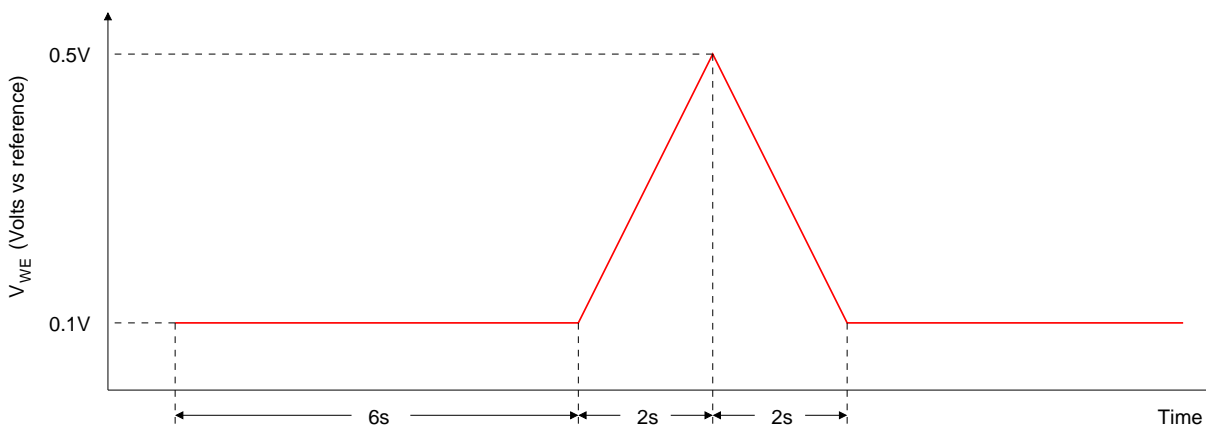

Figure 39: Sample cyclic voltammetry waveform.

8.4.3 Current interrupt IR compensation

This example doesn't completely set up IR compensation, but it illustrates the use of the remote commands described in section 8.3.5 on page 82. Figure 40 below illustrates interruption of current through a resistor with no actual correction applied. The commands below set up the timing parameters and start interruption.

```

IRTYPE 0 Set current interrupt mode
CIOPEN 3000 Set the interruption time to 3ms
CIPERD 10 Set the interruption period to 10ms
CICORR 0 Set the correction amount in percent
CIDLAY 0 100 Set the "open" voltage sampling delay to 100μs
CIDLAY 1 100 Set the "closed" voltage sampling delay to 100μs
IRENAB 1 Turn current interrupt on

```

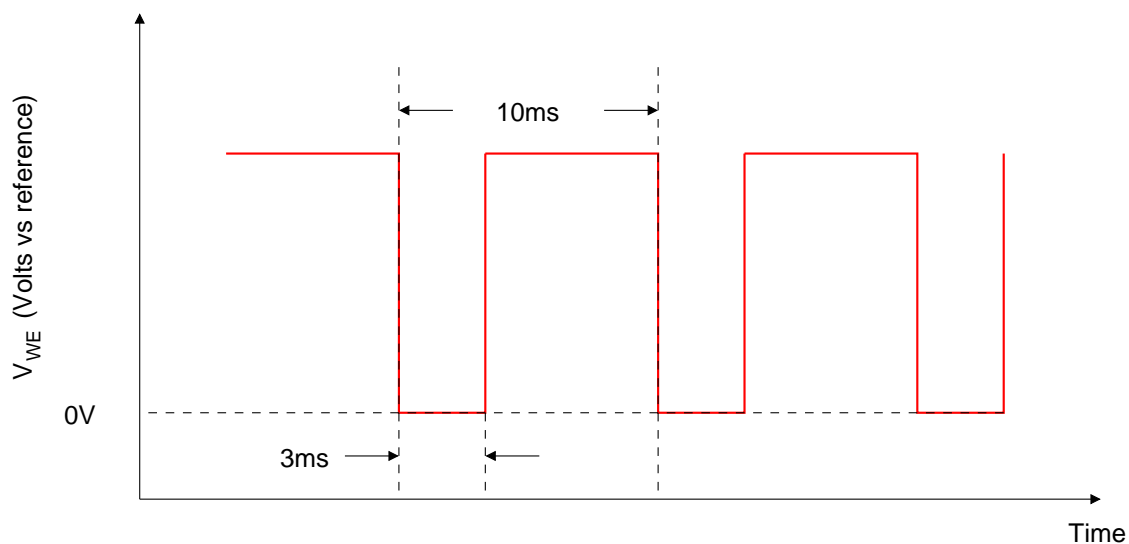

Figure 40: Sample current interruption waveform.

8.4.4 Arbitrary waveform

The following command sequence produces the waveform shown in figure 41. This arbitrary waveform example includes five ARBSET? points and three cycles. The scan ends with the system in control at the first data point.

```

ARBST Reset the arbitrary waveform interface
ARBTYP 1 Waveform data type will be potentiostatic
ARBDLY 1 Hold D0 for one second, then play D1
ARBCYC 3 Cycle the waveform three times
ARBEND 0 Maintain control at D0 when finished
ARBDIV 1000 Play points back at 1MHz/1000 (1ms sample time)
ARBSET? 0 100 Set the D0 point at +100mV.
0 EC301 responds "0"
ARBSET? 1 200 Set the D1 point at +200mV.
0 EC301 responds "0"
ARBSET? 2 500 Set the D2 point at +500mV.
0 EC301 responds "0"
ARBSET? 3 -100 Set the D3 point at -100mV.
0 EC301 responds "0"
ARBSET? 4 -100 Set the D4 point at -100mV.
0 EC301 responds "0"
arbrun 1 Start the scan

```

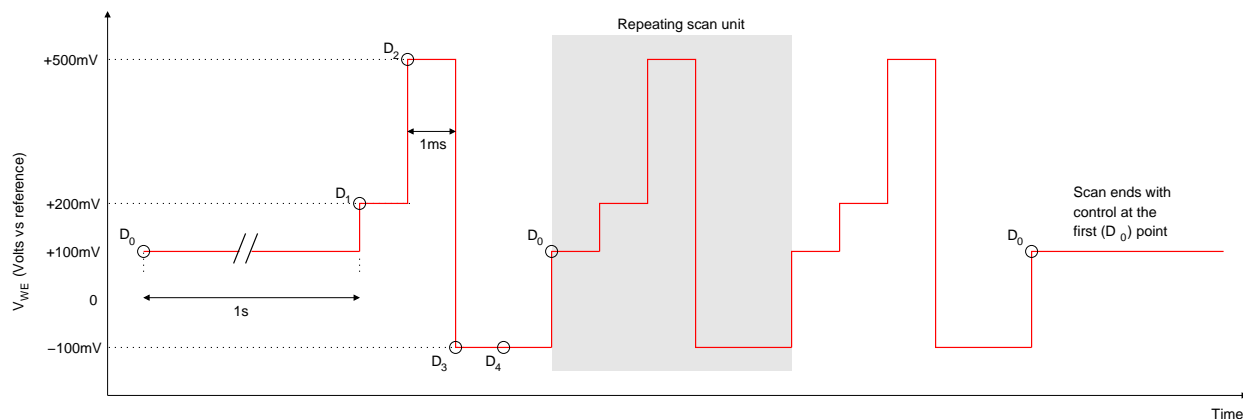

Figure 41: Arbitrary waveform example. Points are played back at the 1MHz/arbdiv, rate, so use repeated values to get longer hold times. Waveforms can have 1600 programmed points.

References

- [1] A. J. Bard and L. R. Faulkner, *Electrochemical Methods: Fundamentals and Applications*. John Wiley and Sons, 1980.

A Measuring cell voltages at the cell

The EC301's WE connection must not be connected to an external instrument's ground when measuring cell voltages. Doing so would divert cell current from the WE to the external ground and thus invalidate current measurements. Figure 42 illustrates good and bad ways of making these measurements. Figure 42a shows a high-impedance differential preamplifier used to buffer the desired voltage before sending it to an oscilloscope. Figure 42b shows a handheld meter used to make the measurement directly. Figure 42c shows the ground "pigtail" of an oscilloscope probe incorrectly connected to the WE electrode – diverting cell current away from the EC301's measurement electronics and possibly destabilizing the cell.

The methods shown in figures 42a and 42b are correct because both probes in each case are floating – not connected to ground. The method shown in 42c is incorrect because the oscilloscope probe pigtail does not float.

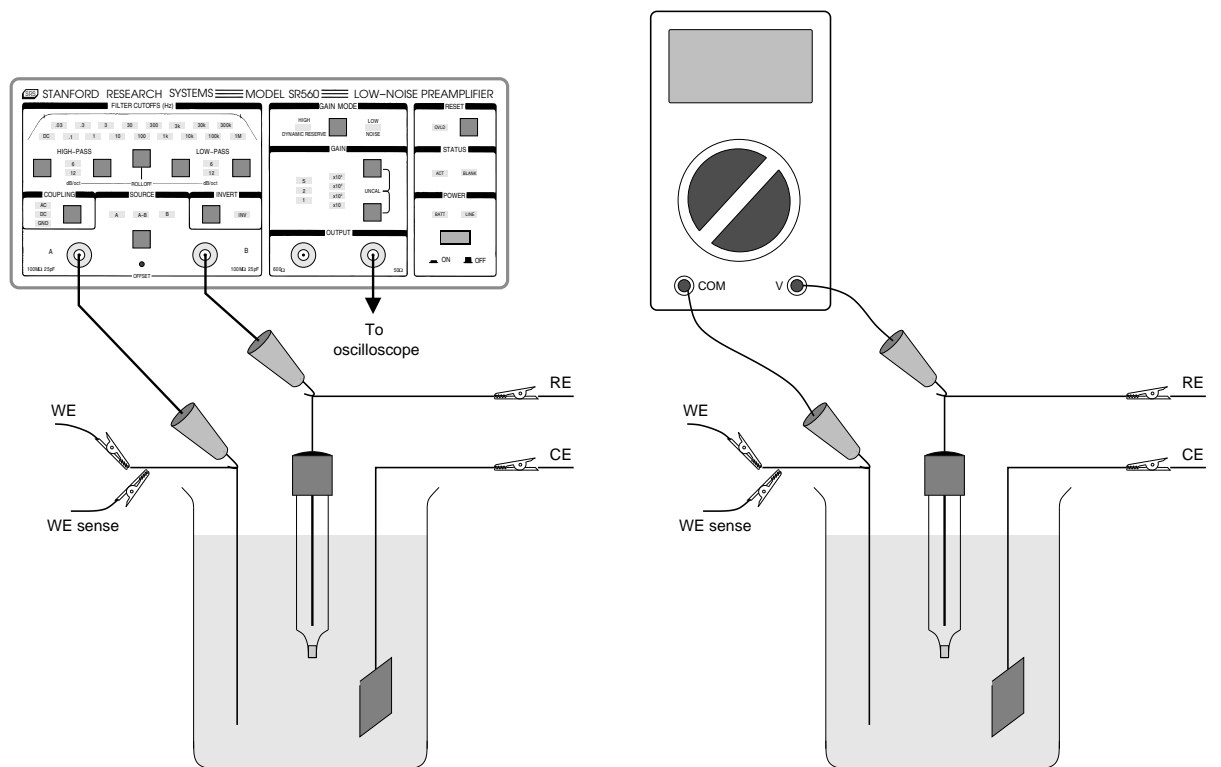

(a) **Correct:** Measurement buffered by high-impedance differential amplifier (the SR560 is shown)

(b) **Correct:** Measurement made directly with a handheld meter

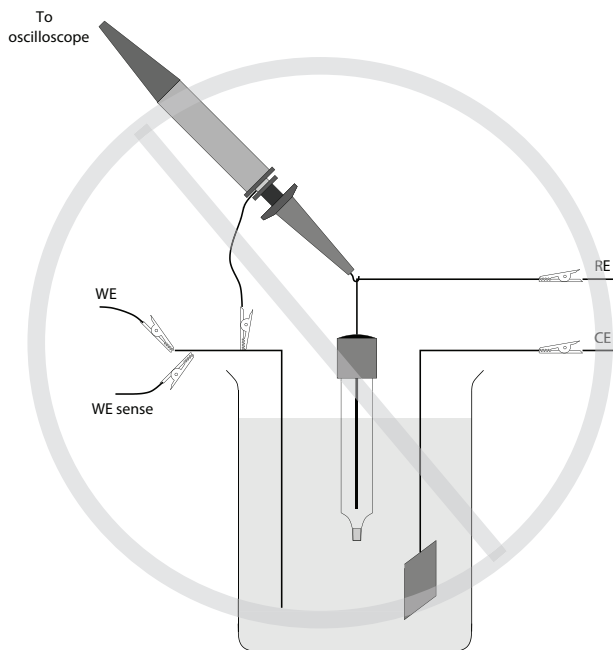

(c) **Incorrect:** Connecting the ground pigtail of an oscilloscope probe to WE

Figure 42: Correct and incorrect ways to make cell voltage measurements with external instruments.

B Pinouts

B.1 Cell interface (25 pins)

Pin	Signal
1	Counter electrode (CE)
2	Serial data to external box (MOSI)
3	Serial data clock
4	Shift register output enable
5	Main voltmeter (RE - WE SENSE) output
6	ZRA voltmeter (CE SENSE - WE SENSE) output
7	-20V referenced to signal ground
8	-12V referenced to signal ground
9	WE connection to internal shunt resistors
10	Output from external shunt resistor buffers
11	+12V referenced to floating ground
12	Ground return for relay actuator current in external box
13	Signal ground
14	Serial data from external box (MISO)
15	Chip select for eeprom in external box
16	Calibrated current source from external box
17	Signal ground
18	Signal ground
19	+20V referenced to signal ground
20	+12V referenced to signal ground
21	+5V referenced to signal ground
22	Floating ground
23	Signal ground
24	-12V referenced to floating ground
25	Chassis ground

Table 11: Pinout for the front panel cell umbilical (DB25) connector

B.2 RTD interface (5 pins)

Pin	Signal
1	High-side voltage sense (SENSE+)
2	Low-side voltage sense (SENSE-)
3	Signal ground (GROUND)
4	Current source (DRIVE+)
5	Current sink (DRIVE-)

Table 12: Pinout for the rear panel RTD connector (numbered left to right)

C Major symbols and abbreviations

Symbol	Meaning	Usual units
E	Potential of an electrode versus a reference	V

Alphabetical command index

- *CLS, 108
*ESE, 102
*ESR?, 101
*IDN?, 97
*OPC(?), 97
*RST, 97
*SRE(?), 108
*STB, 107
*TST?, 97
*WAI, 97
- addscn(?), 77
anyrtd?, 127
arbcyc, 124
arbdiv, 123
arbdly, 123
arbend, 123
arbget?, 125
arbpts?, 123
arbrst, 122
arbrun, 126
arbset, 124
arbtyp, 125
autotb, 100
avgexp, 92
- bireje, 86
bireji, 87
brenab, 86
- bstren, 128
bstrty?, 128
- ceenab, 81
celimt, 79
celimv, 79
cellon?, 81
cicorr, 83
cidlay, 83
ciopen, 82
ciperd, 83
clbwth, 79
- dcntrl, 78
- eadcfl, 88
eadcrg, 88
ecmode, 79
errdcd?, 109
errlst?, 109
errmsg?, 108
exttmb, 100
- fpgarv?, 76
- getaux?, 91
getbda, 93
getbdp, 93
getrtd?, 127
- iadcfl, 89
ifcclr, 98
ilevel?, 91
INSE, 104
INSR?, 103
irange, 89
irenab, 82
irnaut, 90
irtype, 82
- limitg?, 80
lockfp, 98
lpfile, 87
lpfli, 87
- macadr?, 98
MESE, 106
MESR?, 105
- nulcmd, 99
- pdatap, 112
pfbck, 82
pholdt, 112
pincrm, 113
plendm, 115
plimit, 114
plinit, 115
plstop, 116
polbda?, 93
- ppoint, 111
pprogrn?, 115
progrn?, 78
pstart, 116
psteps, 111
- rampcy, 121
rampdt, 119
rampen, 121
ramppg?, 120
ramppt, 117
ramprs, 119
ramprt, 117
rampst, 120
rotate, 85
rtdohm?, 127
- scanem, 121
scantp, 121
scentrg, 84
setcur, 76
setvol, 76
stsync, 84
- trgarm, 84
- verbmd, 98
vfdmsg, 99
vlevel, 91