



# MFK

High Efficiency Multi-Edge Cutter for Cast Iron



Double-Sided Insert with Free Cutting Geometry to Resist Chatter

- 10 Usable Cutting Edges per Insert
- Tough Edge with Low Cutting Forces
- New CVD Grade CA420M for Longer Tool Life



# MFK

Milling Cutter for Cast Iron

Tough edge with low cutting forces enable stable machining.  
Uses 10-edge inserts for economical machining.

## 1 Low Cutting Forces Prevent Chattering

### Low Cutting Forces with Helical Cutting Edge Design

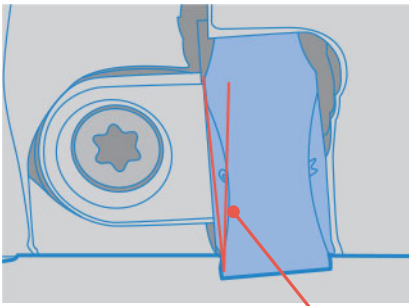

A.R. Max. +15°

Cutting Force Comparison (Internal Evaluation)

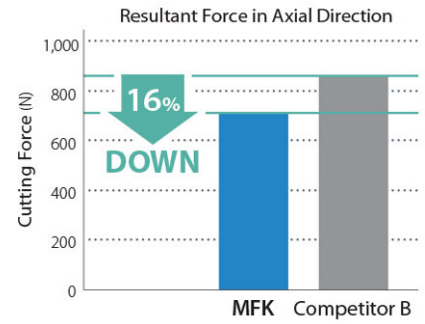
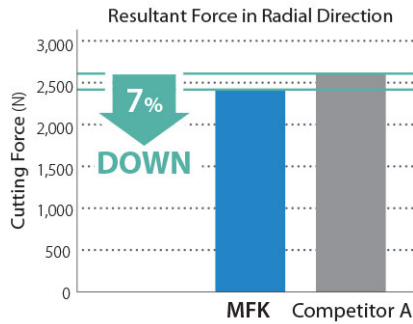

Cutting Conditions:  $V_c = 590$  sfm,  $f_z = 0.012$  ipt,  $ap \times ae = 0.118'' \times 2.441''$ , Dry Workpiece: Nodular Cast Iron (80-60-03),  $\emptyset 5.000''$

## 2 Tough and Reliable Insert Construction Prevents Fracturing

### Tough and Reliable Dual Angle Edge Design

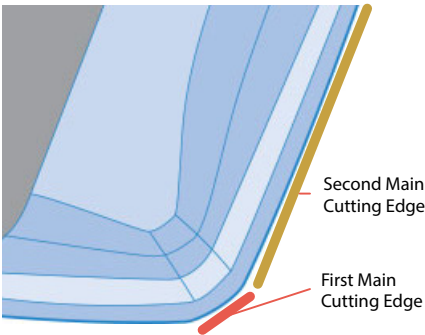

Fracture Resistance Comparison (Internal Evaluation)

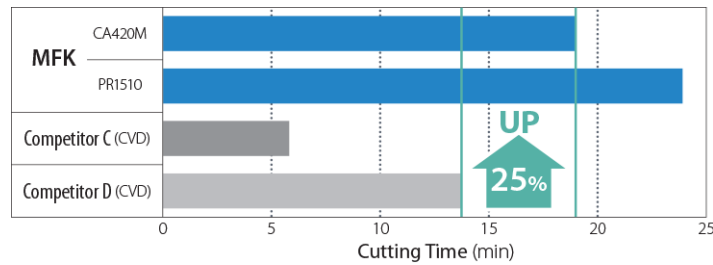

Cutting Conditions:  $V_c = 980$  sfm,  $f_z = 0.020$  ipt,  $ap = 0.079''$ , Wet Workpiece: Nodular Cast Iron (65-45-12) with 4 Bores

Surface Finish Comparison (Internal Evaluation)

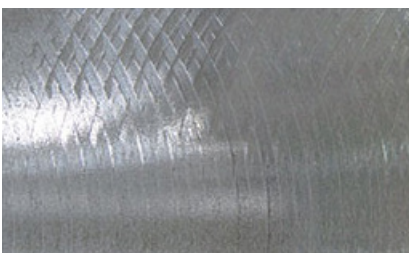

MFK

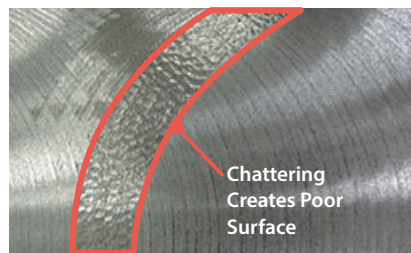

Chattering Creates Poor Surface

Competitor E

Burr Comparison

### Sharp Cutting Prevents Burr Formation

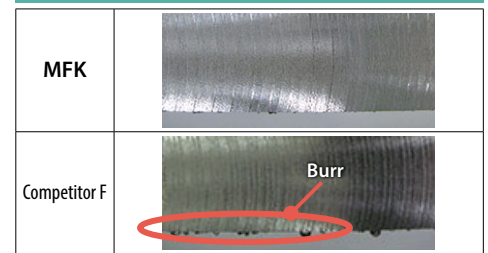

MFK

Competitor F

← Cutting Direction

Cutting Conditions:  $V_c = 590$  sfm,  $f_z = 0.012$  ipt,  $ap \times ae = 0.118'' \times 3.071''$ , Dry Workpiece: Nodular Cast Iron (80-60-03)

### 3 Toolholder Lineup for Various Applications

Fine and Extra Fine Pitch Types Available.



**Fine Pitch**  
(Example: 5000R-11-12T = 12 Inserts)

- Recommended for Unstable Setups
- General Purpose for Wide Application Ranges



**Extra Fine Pitch**  
(Example: 5000R-11-18T = 18 Inserts)

- Recommended for Rigid Setups
- Finer Pitch for Higher Efficiency

### 4 Chipbreaker Lineup for Wide Range of Applications



**General Purpose:**  
GM Chipbreaker



**Heavy Duty:**  
GH Chipbreaker



**Finishing:**  
GL Ground Chipbreaker

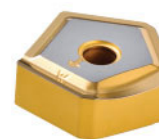

**Wiper Edge:**  
W Ground  
Wiper Edge

### 5 Long Tool Life and Stable Machining

CA420M Features Advanced CVD Coating Technology

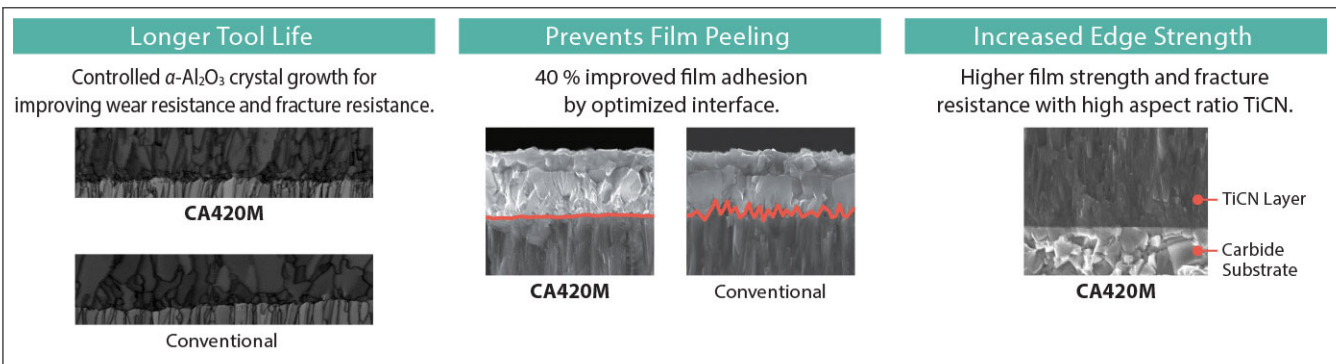

Insert Grade Lineup



Long Tool Life  
(1st Recommendation)  
CA420M



Stable Machining  
PR1510



Fracture Resistance  
PR1525

Use ceramic insert for high speed machining (see page 3).

Wear Resistance Comparison (Internal Evaluation)

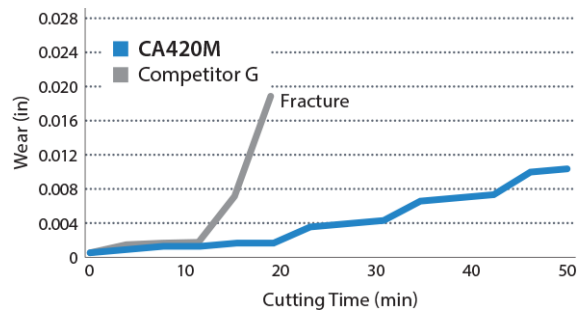

Cutting Conditions: Vc = 670 sfm, fz = 0.012 ipt, ap x ae = 0.079" x 3.150", Dry  
Workpiece: Nodular Cast Iron (65-45-12)

# Ceramic Grades for High Speed and High Efficiency Machining

Low cutting force ceramic insert with chipbreaker controls edge chipping.

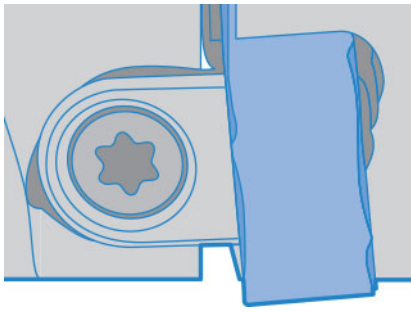

Rake Angle +6.7°

Cutting Force Comparison (Internal Evaluation)

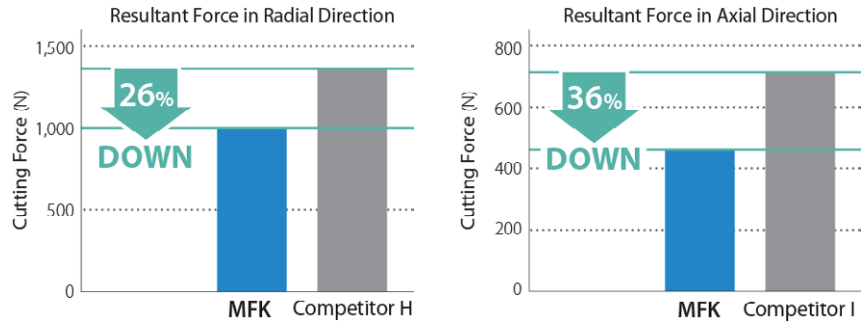

Cutting Conditions: Vc = 1970 sfm, fz = 0.004 – 0.010 ipt, ae × ap = 2.461" × 0.079", DRY Workpiece: Gray Cast Iron (No.45), Ø5.000", 1 Insert

KS6050 First Recommendation for Gray Cast Iron

## 1 High Wear Resistance Enables Stable Machining

Reduces grain boundary phase that generates negative impact on the cutting performance.

KS6050

Less Grain Boundary Phase



Stable Machining Without Chipping

Mechanical and thermal property will be improved by controlling grain boundary phase

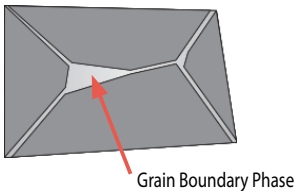

Conventional Grade

More Grain Boundary Phase



Unstable Machining Due to Chipping

The grain boundary phase contained a high proportion of glass, therefore its toughness will be weakened by cutting heat

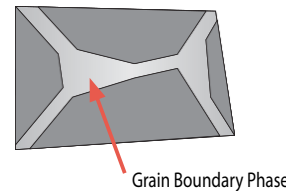

## 2 Prevents Sudden Fracturing

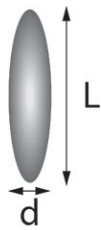
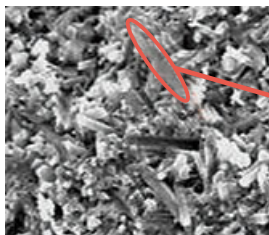

KS6050 has higher aspect ratio compared with conventional grade.

Aspect Ratio = L/d

Crack Propagation

Fracture Resistance Improvement

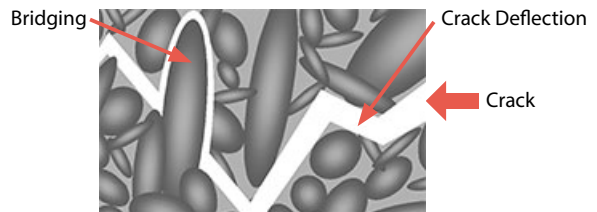

Large Aspect Ratio ⇒ Controls Crack Propagation

CS7050 First Recommendation for Nodular Cast Iron

Wear resistance improvement due to high coating adhesion.

Suitable for high speed cutting.

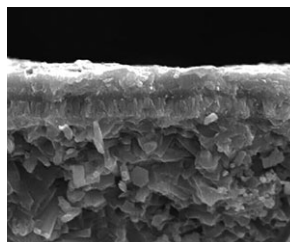

- High Wear Resistant Phase (TiC Base)
- Special Al<sub>2</sub>O<sub>3</sub> Phase
- High Adhesion Phase (TiN Base)
- Si<sub>3</sub>N<sub>4</sub> Substrate

# MFK Face Mill (Inch Sizes)

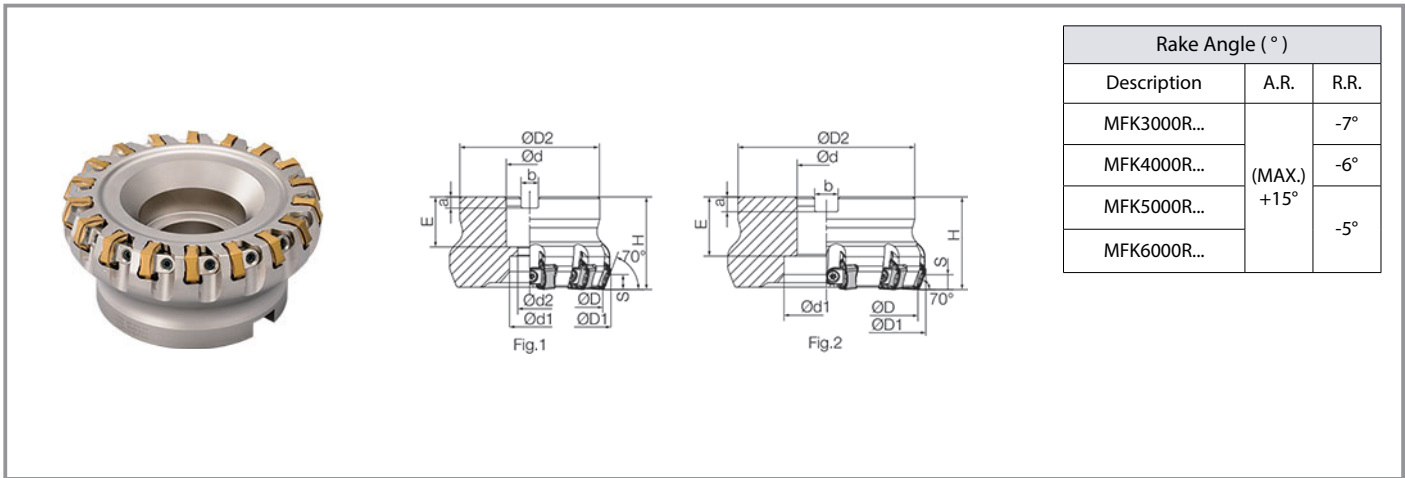

Rake Angle ( ° )		
Description	A.R.	R.R.
MFK3000R...	(MAX.) +15°	-7°
MFK4000R...		-6°
MFK5000R...		-5°
MFK6000R...		

## Toolholder Dimensions

Bore Dia.	Description	Stock	No. of inserts	Dimensions (in)											Drawing	Weight (kg)	
				ØD	ØD1	ØD2	Ød	Ød1	Ød2	H	E	a	b	s			
Inch Spec	Fine Pitch	MFK 3000R-11-8T	●	8	3.000	3.340	2.750	1.000	0.866	0.551	2.480	1.063	0.240	0.382	0.236	Fig.1	1.610
		4000R-11-10T	●	10	4.000	4.340	3.750	1.500	1.299	0.866		1.181	0.390	0.626		Fig.1	2.860
		5000R-11-12T	●	12	5.000	5.340	3.750	1.500	2.047	-		1.496	0.390	0.626		Fig.2	3.670
		6000R-11-16T	●	16	6.000	6.340	4.880	2.000	2.835	-		1.496	0.430	0.752		Fig.2	4.940
	Extra Fine Pitch	MFK 3000R-11-10T	●	10	3.000	3.340	2.750	1.000	0.866	0.551		1.063	0.240	0.382		Fig.1	1.550
		4000R-11-14T	●	14	4.000	4.340	3.750	1.500	1.299	0.866		1.181	0.390	0.626		Fig.1	2.740
		5000R-11-18T	●	18	5.000	5.340	3.750	1.500	2.047	-		1.496	0.390	0.626		Fig.2	3.480
		6000R-11-22T	●	22	6.000	6.340	4.880	2.000	2.835	-		1.496	0.430	0.752		Fig.2	4.760

## Spare Parts and Applicable Inserts

● : U.S. Stock

Description	Spare Parts						Applicable Inserts ➔ P7
	Wedge 	Wedge Screw 	Wrench 	Mounting Bolt 	Pre-Set Torque Wrench* 		
MFK 3000R-11-8T	C09N	W6X18N	TT-15	HH1/2-1.25	PST-T15	PNMG1106XNEN-GM PNMG1106XNEN-GH PNEG1106XNEN-GL PNEG1106XNER-W PNEA1106XNTN-T01020 PNEG1106XNTR-T00515	
4000R-11-10T				HH3/4-2.3			
5000R-11-12T				-			
6000R-11-16T				-			
MFK 3000R-11-10T	C09N	W6X18N	TT-15	HH1/2-1.25	PST-T15		
4000R-11-14T				HH3/4-2.3			
5000R-11-18T				-			
6000R-11-22T				-			

\*For prolonged insert and cutter life, it is recommended to use the pre-set torque wrench to ensure proper insert screw force.  
Pre-Set Torque Wrench sold separately

# MFK Face Mill (Metric Sizes)

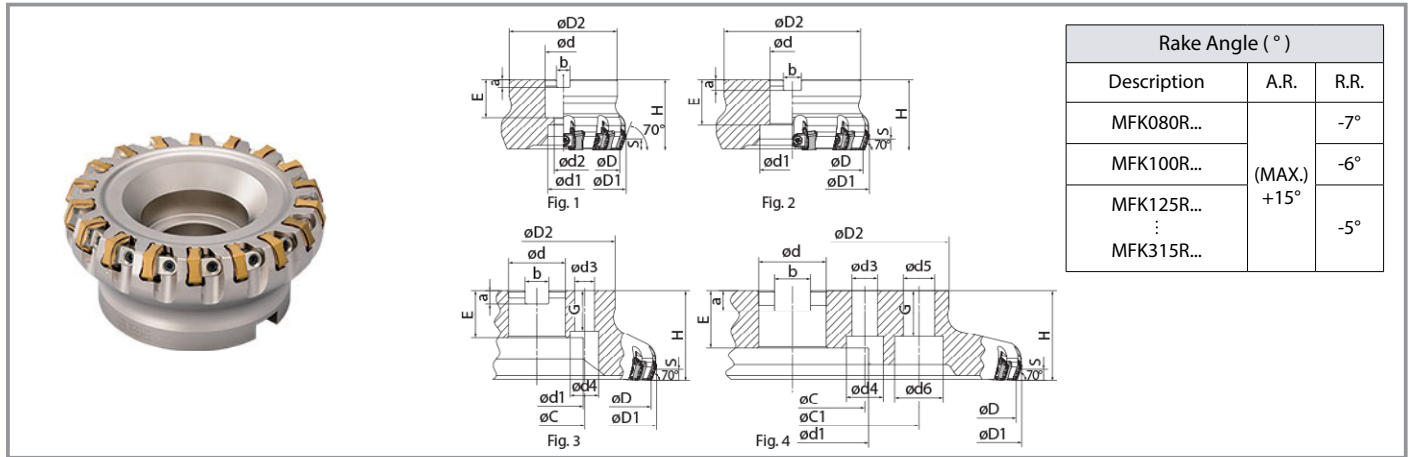

## Toolholder Dimensions

Bore Dia.	Description	Stock	No. of inserts	Dimensions (mm)																Drawing	Weight (kg)					
				ØD	ØD1	ØD2	Ød	Ød1	Ød2	H	E	a	b	s	Ød3	Ød4	Ød5	Ød6	ØC			ØC1	G			
Inch Spec	Fine Pitch	MFK 080R-11-8T	8	80	89	76	31.750"	26	17	63	32	8	12.7	6.0	-	-	-	-	-	-	-	-	Fig. 1	1.76		
		100R-11-10T	10	100	109	96	31.750"	26	17		32	8	12.7		-	-	-	-	-	-	-	-	-	Fig. 1	2.98	
		125R-11-12T	12	125	134	100	38.100"	55	-		38	10	15.9		-	-	-	-	-	-	-	-	-	-	Fig. 2	3.65
		160R-11-16T	16	160	169	100	50.800"	70	-		38	11	19.1		-	-	-	-	-	-	-	-	-	-	Fig. 2	4.62
		200R-11-20T	20	200	209	142	47.625"	110	-		40	14	25.4		18	26	-	-	101.6	-	32	Fig. 3	7.65			
		250R-11-24T	24	250	259	142	47.625"	110	-		40	14	25.4		18	26	-	-	101.6	-	32	Fig. 3	10.73			
	315R-11-28T	MTO	28	315	324	220	47.625"	110	-	40	14	25.4	18	26	22	32	101.6	177.8	32	Fig. 4	19.71					
	Extra Fine Pitch	MFK 080R-11-10T	10	80	89	76	31.750"	26	17	63	32	8	12.7	6.0	-	-	-	-	-	-	-	-	Fig. 1	1.70		
		100R-11-14T	14	100	109	96	31.750"	26	17		32	8	12.7		-	-	-	-	-	-	-	-	-	Fig. 1	2.85	
		125R-11-18T	18	125	134	100	38.100"	55	-		38	10	15.9		-	-	-	-	-	-	-	-	-	Fig. 2	3.44	
		160R-11-22T	22	160	169	100	50.800"	70	-		38	11	19.1		-	-	-	-	-	-	-	-	-	Fig. 2	4.44	
		200R-11-28T	28	200	209	142	47.625"	110	-		40	14	25.4		18	26	-	-	101.6	-	32	Fig. 3	7.40			
		250R-11-36T	36	250	259	142	47.625"	110	-		40	14	25.4		18	26	-	-	101.6	-	32	Fig. 3	10.36			
	315R-11-44T	MTO	44	315	324	220	47.625"	110	-	40	14	25.4	18	26	22	32	101.6	177.8	32	Fig. 4	19.21					
Metric Spec	Fine Pitch	MFK 080R-11-8T-M	8	80	89	76	27	20	13	63	24	7	12.4	6.0	-	-	-	-	-	-	-	-	Fig. 1	1.87		
		100R-11-10T-M	10	100	109	96	32	26	17		28	8	14.4		-	-	-	-	-	-	-	-	-	Fig. 1	2.99	
		125R-11-12T-M	12	125	134	100	40	55	-		33	9	16.4		-	-	-	-	-	-	-	-	-	Fig. 2	3.56	
		160R-11-16T-M	16	160	169	100	40	70	-		33	9	16.4		14	20	-	-	66.7	-	28	Fig. 3	4.51			
		200R-11-20T-M	20	200	209	142	60	110	-		40	14	25.7		18	26	-	-	101.6	-	32	Fig. 3	7.35			
		250R-11-24T-M	24	250	259	142	60	110	-		40	14	25.7		18	26	-	-	101.6	-	32	Fig. 3	10.43			
	315R-11-28T-M	MTO	28	315	324	220	60	110	-	40	14	25.7	18	26	22	32	101.6	177.8	32	Fig. 4	19.41					
	Extra Fine Pitch	MFK 080R-11-10T-M	10	80	89	76	27	20	13	63	24	7	12.4	6.0	-	-	-	-	-	-	-	-	Fig. 1	1.81		
		100R-11-14T-M	14	100	109	96	32	26	17		28	8	14.4		-	-	-	-	-	-	-	-	-	Fig. 1	2.86	
		125R-11-18T-M	18	125	134	100	40	55	-		33	9	16.4		-	-	-	-	-	-	-	-	-	Fig. 2	3.38	
		160R-11-22T-M	22	160	169	100	40	70	-		33	9	16.4		14	20	-	-	66.7	-	28	Fig. 3	4.32			
		200R-11-28T-M	28	200	209	142	60	110	-		40	14	25.7		18	26	-	-	101.6	-	32	Fig. 3	7.10			
		250R-11-36T-M	36	250	259	142	60	110	-		40	14	25.7		18	26	-	-	101.6	-	32	Fig. 3	10.07			
		315R-11-44T-M	MTO	44	315	324	220	60	110		-	40	14		25.7	18	26	22	32	101.6	177.8	32	Fig. 4	18.92		

○ : World Express (Shipping: 7-10 Business Days) MTO : Made to Order

## Spare Parts and Applicable Inserts

Description	Spare Parts					Applicable Inserts P7
	Wedge	Wedge Screw	Wrench	Mounting Bolt	Pre-Set Torque Wrench*	
MFK 080R-11-8T-M	C09N	W6X18N	TT-15	HH12X35	PST-T15	PNMG1106XNEN-GM PNMG1106XNEN-GH PNEG1106XNEN-GL PNEG1106XNER-W PNEA1106XNTN-T01020 PNEG1106XNTR-T00515
080R-11-8T				HH16X40		
100R-11-10T (-M)				-		
125R-11-12T (-M)				-		
160R-11-16T (-M)				-		
200R-11-20T (-M)				-		
250R-11-24T (-M)				-		
315R-11-28T (-M)	-					
MFK 080R-11-10T-M	C09N	W6X18N	TT-15	HH12X35	PST-T15	PNMG1106XNEN-GM PNMG1106XNEN-GH PNEG1106XNEN-GL PNEG1106XNER-W PNEA1106XNTN-T01020 PNEG1106XNTR-T00515
080R-11-10T				HH16X40		
100R-11-14T (-M)				-		
125R-11-18T (-M)				-		
160R-11-22T (-M)				-		
200R-11-28T (-M)				-		
250R-11-36T (-M)				-		
315R-11-44T (-M)				-		

\*For prolonged insert and cutter life, it is recommended to use the pre-set torque wrench to ensure proper insert screw force. Pre-Set Torque Wrench sold separately

# Applicable Inserts

Insert	Description	Dimensions (in)				CVD Coated Carbide	MEGACOAT NANO		Silicon Nitride Ceramic	CVD Silicon Nitride Ceramic
		A	T	X	Z		CA420M	PR1510		
General	PNMG 1106XNEN-GM	0.678	0.250	0.079	0.079	●	●	●	-	-
Tough Edge	PNMG 1106XNEN-GH	0.678	0.250	0.079	0.079	●	●	●	-	-
Surface Finish Oriented	PNEG 1106XNEN-GL	0.676	0.250	0.102	0.102	●	●	●	-	-
Wiper Insert (Z-edge)	PNEG 1106XNER-W	0.709	0.250	0.079	0.394	●	●	●	-	-
High Speed	PNEA 1106XNTN-T01020	0.667	0.256	0.059	0.059	-	-	-	●	●
High Speed (with Chipbreaker)	PNEG 1106XNTR-T00515	0.672	0.250	-	-	-	-	-	●	●

● : U.S. Stock

## Recommended Conditions ★ 1st Recommendation ☆ 2nd Recommendation

Workpiece Material	Insert Grade	Cutting Speed (sfm)	Chipbreaker	Feed per Tooth fz (ipt)				
				0.0024	0.0039	0.0079	0.0018	0.0158
Gray Cast Iron (FC)	CA420M	560 – 750 – 980	GM ★			● 0.0098		
	PR1510	390 – 590 – 820	GH ☆				● 0.0118	
	PR1525		GL		● 0.0047			
Nodular Cast Iron (FCD)	CA420M	490 – 660 – 820	GM ★			● 0.0079		
	PR1510	330 – 490 – 660	GH ☆				● 0.0098	
	PR1525		GL		● 0.0039			

## Recommended Conditions (Ceramic) ★ 1st Recommendation ☆ 2nd Recommendation

Without Chipbreaker

Workpiece Material	Insert Grade	Cutting Speed (sfm)	Edge Preparation	Feed per Tooth fz (ipt)				
				0.0020	0.0039	0.0079	0.0018	0.0158
Gray Cast Iron (FC)	KS6050 ★ / CS7050 ☆	1970 – 2950 – 3940	0.004 × 20°			● 0.0039		
Nodular Cast Iron (FCD)	KS6050 ☆ / CS7050 ★	1310 – 1970 – 2950						

With Chipbreaker

Workpiece Material	Insert Grade	Cutting Speed (sfm)	Edge Preparation	Feed per Tooth fz (ipt)				
				0.0024	0.0039	0.0079	0.0018	0.0158
Gray Cast Iron (FC)	KS6050 ★ / CS7050 ☆	1970 – 2950 – 3940	0.002 × 15°			● 0.0039		
Nodular Cast Iron (FCD)	KS6050 ☆ / CS7050 ★	1310 – 1970 – 2950						

## Recommended Application Range

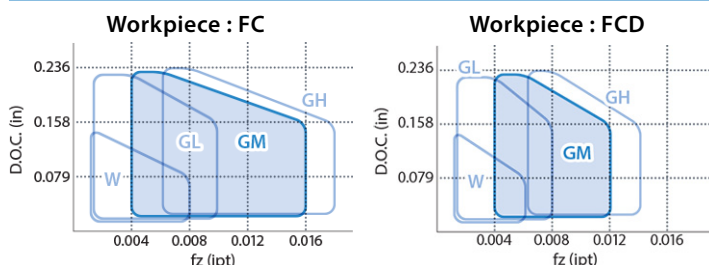

## Recommended Application Range (Ceramic)

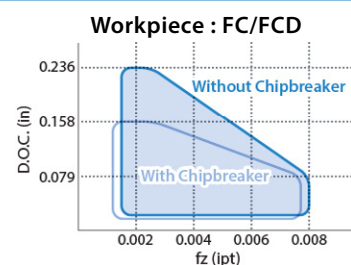

- When using W (wiper), please use together with GM or GH. (Not recommended for use with GL)
- When using wiper, do not exceed fz = 0.008 ipt or insert corner may be damaged. The main cutting edge of W (wiper) insert is receding from that of GM and GH. Therefore, the feed rate for the insert next to W (wiper) is double that of other inserts.

## Case Studies

### Machine Base (No.45)

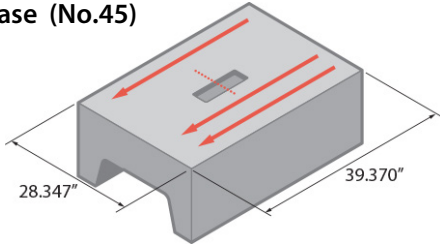

Vc = 525 sfm  
 fz = 0.006 ipt (Vf = 30.787 in/min)  
 ap x ae = 0.118" x 3.937" Dry  
 MFK125R-11-12T (12 Inserts)  
 PNMG1106XNEN-GM PR1510

Chip Removal Rate

**PR1510** **235cc/min**

Efficiency

x2

Competitor J  
 (12 Inserts)

**125cc/min**

Little noise and vibration with increased cutting speed and feed rate.

(User Evaluation)

### Base (No.45)

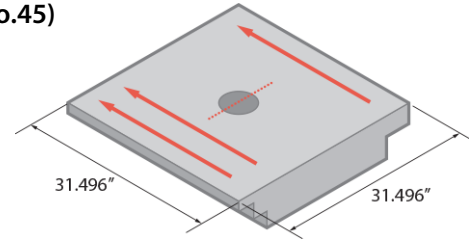

Vc = 525 sfm  
 fz = 0.007 ipt (Vf = 36.102 in/min)  
 ap x ae = 0.118" x 5.512" Dry  
 MFK200R-11-20T (20 Inserts)  
 PNMG1106XNEN-GM CA420M

Chip Removal Rate

**CA420M** **385cc/min**

Efficiency

x2.3

Competitor K  
 (12 Inserts)

**167cc/min**

CA420M performed at 2.3 times the efficiency of Competitor K.

Little noise and stable machining.

(User Evaluation)

### Mold Part (80-60-03)

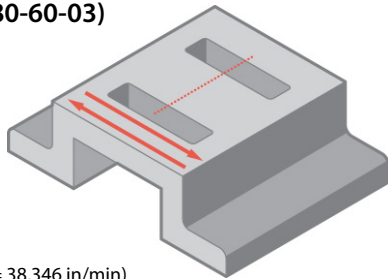

Vc = 300 sfm  
 fz = 0.013 ipt (Vf = 38.346 in/min)  
 ap x ae = 0.079" x ~2.362" Dry  
 MFK080R-11-8T (8 Inserts)  
 PNMG1106XNEN-GM PR1525

Machining Efficiency

**PR1525** **3pcs/edge**

Tool Life

x3

Competitor L  
 (8 Inserts)

**1pcs/edge**

Competitor L had chipping after machining 1pc. PR1525 kept good edge condition and stable machining after machining 3 pcs.

(User Evaluation)

### Bed (No.50)

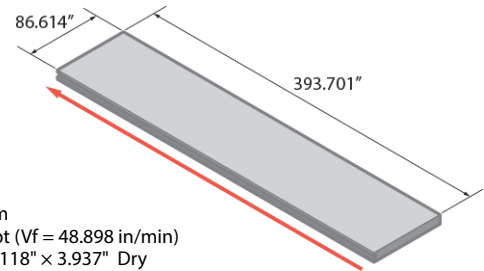

Vc = 490 sfm  
 fz = 0.010 ipt (Vf = 48.898 in/min)  
 ap x ae = 0.118" x 3.937" Dry  
 MFK160R-11-16T (16 Inserts)  
 PNMG1106XNEN-GM CA420M

Chip Removal Rate

**CA420M** **372cc/min**

Efficiency

4 Times

Competitor M  
 (8 Inserts)

**93cc/min**

CA420M improved the efficiency by 4 times compared with Conventional M.

(User Evaluation)



**KYOCERA Precision Tools, Inc.**

102 Industrial Park Road  
 Hendersonville, NC 28792  
 Customer Service | 800.823.7284 - Option 1  
 Technical Support | 800.823.7284 - Option 2



Official Website | [www.kyoceraprecisiontools.com](http://www.kyoceraprecisiontools.com)  
 Distributor Website | [mykpti.kyocera.com](http://mykpti.kyocera.com)  
 Email | [cuttingtools@kyocera.com](mailto:cuttingtools@kyocera.com)

©KYOCERA Precision Tools, Inc.