

Helping Customers Innovate, Improve & Grow



Features

- 9x14 J-Leaded Surface Mount Package
- AC MOS, TTL and LVPECL
- Available with 4 point crystal mount for Harsh Environment Applications
- Military Temperature Range Option
- Frequency Range: 1 MHz to 800 MHz
- Previous Model: C5300, MC044, MC344, MC046, MC346, MC047, MC347, MC049, MC349, MC048, MC318, MC328, and MC348

Performance Specifications

Parameter	Min	Typ	Max	Units	Condition
Frequency Stabilities¹					
vs. operating temperature range (absolute pull range)					0...70°C -40...+85°C -55...+125°C
vs. supply voltage change	-2		+2	ppm	Vs ± 5%
vs. load change	-1		+1	ppm	Load ± 5%
vs aging / 1 year	-5	±3	+5	ppm	
vs aging / year (following years)	-1		+1	ppm	
Supply Voltage (Vs)					
Supply voltage	4.75	5.0	5.25	VDC	
Current consumption			15 20 40 100	mA mA mA mA	ACMOS/TTL 1 to 23.9 MHz ACMOS/TTL 24 to 49.9 MHz ACMOS/TTL 50 to 80.0 MHz LVPECL No load
Supply voltage	3.135	3.3	3.465	VDC	
Current consumption			6 8 12 16 60 100	mA mA mA mA mA mA	ACMOS 1.0 to 14.90 MHz ACMOS 15.0 TO 39.9 MHz ACMOS 40.0 TO 59.9 MHz ACMOS 60.0 TO 79.9 MHz ACMOS 80.0 to 125.0 MHz LVPECL No load

Performance Specifications

Parameter	Min	Typ	Max	Units	Condition
RF Output					
Signal	ACMOS				
Load		15	50	pF	
Signal Level (Vol)			0.5 0.3	VDC VDC	V _s = 5.0V and 15pF load V _s = 3.3V and 15pF load
Signal Level (Voh)	4.5 3.0			VDC VDC	V _s = 5.0V and 15pF load V _s = 3.3V and 15pF load
Rise and fall times for ACMOS (measured 10% to 90%)			10 5 3	ns ns ns	1.0 to 23.9 MHz 24.0 to 79.7 MHz 80.0 to 125.0 MHz
Duty cycle	45 40		55 60	% %	@ 50% < 15 MHz @ 50% ≥ 15 MHz
Signal	TTL				
Load			10	pF	
Signal Level (Vol)			0.5	VDC	
Signal Level (Voh)	+4.5			VDC	
Rise and fall times for TTL (measured 0.8V to 2.0V)			5 3	ns ns	1.0 to 23.9 MHz 24.0 to 125.0 MHz
Duty cycle	45 40		55 60	% %	@ 1.4V < 15 MHz @ 1.4V ≥ 15 MHz
Signal	PECL/LVPECL				
Load			50	ohm	Into V _s -2V or There in Equivalent
Signal Level (Vol)			V _s -1.62	VDC	
Signal Level (Voh)	V _s -1.025			VDC	
Rise and fall times (measured 20% to 80%)			1000 600	ps ps	<100 MHz >100 MHz
Start-up Time			10	ms	
Duty cycle (LVPECL)	45 40		55 60	% %	@ 50% V _{dd} @ 50% V _{dd}
Jitter (rms)			5 1	ps ps	BW = 10Hz to 20 MHz BW = 12 kHz to 20 MHz
Period Jitter (pk-pk)			40	ps	10,000 samples- Rising edge
Frequency Tuning (EFC)					
Absolute Pull Range		±30 ±50		ppm ppm	
Linearity		10	15	%	
Tuning Slope	Positive				
Control Voltage Range	0.5 0.3	2.5 1.65	4.5 3.0	VDC VDC	with V _s =5.0VDC with V _s =3.3VDC
Additional Parameters					
Phase Noise ³ (@ 52 MHz)			-60 -90 -120 -140 -145	dBc/Hz dBc/Hz dBc/Hz dBc/Hz dBc/Hz	10 Hz 100 Hz 1 KHz 10 KHz 100 KHz

Performance Specifications

Parameter	Min	Typ	Max	Units	Condition
Phase Noise ³ (@ 155.52 MHz)			-50	dBc/Hz	10 Hz
			-80	dBc/Hz	100 Hz
			-110	dBc/Hz	1 kHz
			-133	dBc/Hz	10 KHz
			-145	dBc/Hz	100 KHz
Screening	Vectron Verification or Class B Screening I/A/W MIL-PRF55310				
Standard Environmentals					
Vibration	MIL-STD-202, Method 204, Condition G (30G, 10Hz-2000Hz)				
Shock	MIL-STD-202, Method 213, Condition I (100G, 6ms, Sawtooth)				
Acceleration	MIL-STD-883, Method 2001, Condition A (5000G, Y1 Plane)				
Temperature Cycling	MIL-STD-883, Method 1010, Condition B				
Thermal Shock	MIL-STD-202, Method 107, Condition B				
Solderability	MIL-STD-202, Method 208				
Leak Test (Fine and Gross)	MIL-STD-883, Method 1014, Condition A1 and C1				
Weight			<2.0	g	
Processing & Packing					Handling & processing note
Output Enable ⁶	Logic "0" input = Outputs disabled (Tri-state) Logic "1" or floating input = Outputs enabled				ACMOS/TTL Output
	Logic "0" or floating input = Outputs enabled Logic "1" input = Outputs disabled (Tri-state)				PECL/LVPECL Output
Absolute Maximum Ratings					
Supply voltage (Vs)			7.0	V	with Vs=5.0 and 3.3 VDC
Operable temperature range	-55		+125	°C	
Storage temperature range	-55		+125	°C	

Outline Drawing / Enclosure

Dimensions: Inches (mm)

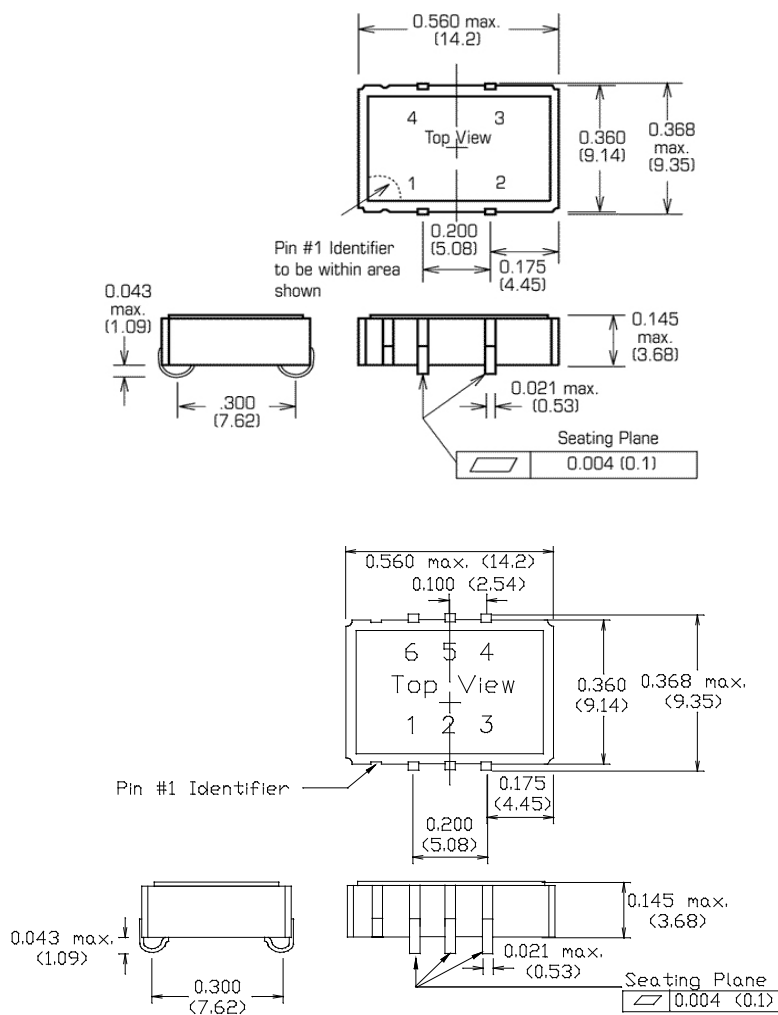

Type A (ACMOS/TTL)		
Code	Height "H"	Pin Length
0	3.68	1.09

Pin Connections	
1	VCXO input
2	Ground (Case)
3	RF Output
4	Supply

Type B (ACMOS/TTL)		
Code	Height "H"	Stand-off
1	3.68	1.09

Type B (PECL/LVPECL)		
Code	Height "H"	Stand-off
1	3.68	1.09

Pin Connections	
1	VCXO input
2	Enable/Disable or N/C
3	Ground (Case)
4	RF Output
5	N/C
6	Supply Voltage

Pin Connections	
1	VCXO input
2	Enable/Disable or N/C
3	Ground (Case)
4	RF Output
5	Complementary Output
6	Supply Voltage

Ordering Information

VX - 500 0 - D A T - K X X X - 10M0000000

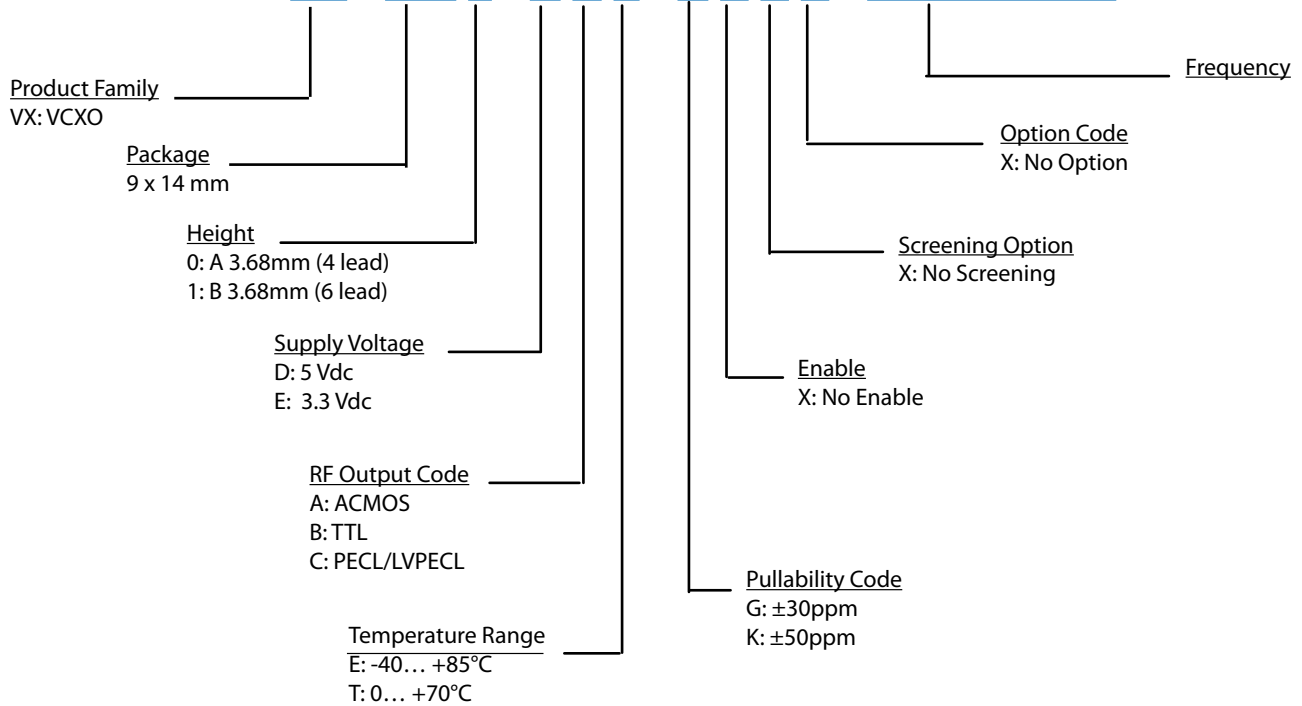

Notes:

1. Contact factory for improved stabilities or additional product options. Not all options and codes are available at all frequencies.
2. Unless other stated all values are valid after warm-up time and refer to typical conditions for supply voltage, frequency control voltage, load, temperature (25°C).
3. Phase noise degrades with increasing output frequency.
4. Subject to technical modification.
5. Contact factory for availability.

For Additional Information, Please Contact

USA:

Vectron International
267 Lowell Road, Unit 102
Hudson, NH 03051
Tel: 1.888.328.7661
Fax: 1.888.329.8328

Europe:

Vectron International
Landstrasse, D-74924
Neckarbischofsheim, Germany
Tel: +49 (0) 3328.4784.17
Fax: +49 (0) 3328.4784.30

Asia:

Vectron International
68 Yin Cheng Road(C), 22nd Floor
One LuJiaZui
Pudong, Shanghai 200120, China
Tel: 86.21.6194.6886
Fax: 86.21.6194.6699

Disclaimer

Vectron International reserves the right to make changes to the product(s) and or information contained herein without notice. No liability is assumed as a result of their use or application. No rights under any patent accompany the sale of any such product(s) or information.