

Wall Industries, Inc.

LV12S5-100

Low Voltage DC-DC Converter
10-36 Vdc Input
5Vdc Output at 20A
Half-Brick Package



Applications:

- For use in 12V and 24V battery applications.
- For use in Intermediate and Distributed Bus Architectures (IBA)
- Telecommunication equipment
- Network (LANs/WANs) Equipment
- Next generation low voltage, high current microprocessors and Ics

Features:

- Up to 88% Efficient
- Cost Efficient Solution
- Delivering 20A at Room Temperature with No Added Heat Sink with 400LFM
- Fixed Switching Frequency
- High Reliability
- Consult Factory for Optional Heat Sink
- Output Short Circuit Protection
- Output Over Current Protection
- Optional Encapsulation for added Ruggedness
- Remote ON/OFF
- Remote Sense Compensation to 10% Vout
- Fast Transient Response
- 100% Burn In
- Soft Start

Description:

The LV12S5-100 is a high density, low input voltage, isolated converter with a wide input voltage range. Low input voltage converters are uncommon in the industry and the LV12S5-100 offers the flexibility of operation with both 12V and 24V busses. This state-of-the-art converter's features include fast transient response, short circuit protection, over current protection, soft start, and many other features that are required for today's demanding applications.

Technical Specifications		Model No. LV12S5-100			
<p>All specifications are based on 25°C, Nominal Input Voltage and Maximum Output Current unless otherwise noted. We reserve the right to change specifications based on technological advances.</p>					
SPECIFICATION	Related condition	Min	Nom	Max	Unit
Switching Frequency		-	300	-	kHz
INPUT (V_{in})					
Operating Voltage Range		10	12 / 24	36	Vdc
UVLO Turn On at		9.4	9.5	9.6	Vdc
UVLO Turn Off at		9.3	9.4	9.5	Vdc
Maximum Input Current	Low Line	-	11.45	-	A
No Load Input Current	No Load	-	0.44	-	A
Input Current under "Remote Off"		-	0.013	-	A
Reflected Ripple Current		-	150	-	mA
Input Surge Voltage	100 mS			50	Vdc
EFFICIENCY		-	87.3	-	%
OUTPUT (V_o)					
Voltage Set Point	±RS shorted to ±Vo	4.95 -1%	5.0	5.05 +1%	Vdc %
Voltage Adjustment	Max Output limited to 100W	4.5 -10%	5.0	5.5 +10%	Vdc
Load Regulation	±RS shorted to ±Vo	-	0.1	0.2	%
Line Regulation	±RS shorted to ±Vo	-	0.1	0.2	%
Temperature Drift		-	0.2	-	% / °C
Remote Sense Compensation	Max Output limited to 100W	-		5.5 10%	Vdc %
Ripple	1uF Ceramic & 10uF Tantalum	-	75	-	mV _{pk-pk}
Spikes	1uF Ceramic & 10uF Tantalum	-	-	-	mV _{pk-pk}
Current		0	-	20	A
Current Limit	Power Limited-Dependent upon SENSE compensation and TRIM adjustment	-	26	-	A
Over Voltage Limit	Output Clamped	-	-	-	Vdc
DYNAMIC RESPONSE					
	1uF Ceramic & 10uF Tantalum				
Load step / ΔV	50% to 100% I _o , di/dt=1A/uS	-	300	-	mV
Recovery Time	Recovery to within 1% Nominal V _o	-	0.25	-	ms
Turn On Delay	From V _{in} (min) to V _{out} (nom)	-	7	-	ms
Turn On Overshoot	Full Load Resistive	-	0	-	%
Hold Up Time	From V _{in} (min) to V _{UVLO_Turn_Off}	0	-	-	mS
REMOTE ON/OFF					
Active High					
Remote ON – Active High	Min High (ON/OFF pin)	2.2	-	-	Vdc
Remote ON – Active Low	Max Low (ON/OFF pin)	N/A	-	-	Vdc
Remote OFF – Active High	Max Low (ON/OFF pin)	-	-	1.2	Vdc
Remote OFF – Active Low	Min High (ON/OFF pin)	N/A	-	-	Vdc
Remote ON/OFF pin Floating – Active High	Over Operating Voltage Range	2.5	-	5.0	Vdc
Remote ON/OFF pin Floating – Active Low	Over Operating Voltage Range	N/A	-	-	Vdc
I _{ON/OFF} Sink to pull low – Active Low or High	V _{ON/OFF} =0V, V _{in} =36V	-	-	0.38	mA
I _{ON/OFF} Source to drive high – Active High	V _{ON/OFF} =5V, V _{in} =36V	-	-	0.03	mA
I _{ON/OFF} Source to drive high – Active Low	V _{ON/OFF} =5V, V _{in} =36V	-	-	-	mA
Turn On Delay – Active High	ON/OFF (max Low) to V _{out} (min)	-	9	-	ms
Turn Off Delay – Active High	ON/OFF (0V) to V _{out} (min)	-	160	-	uS
ISOLATION					
Input-Output	1 minute	-	1500	-	Vdc
Input-Case	1 minute	-	500	-	Vdc
Output-Case	1 minute	-	500	-	Vdc
THERMAL					
Ambient	Max. Ambient limited by OTP	-40	25	OTP	°C
Over Temperature Protection (OTP)	Case Temperature Greater than	-	100	-	°C
Turn On (OTP)	Case Temperature Less than	-	95	-	°C
MTBF	Calculated Using Bellcore TR-332 Method 1 case 3		2,563,116		hours
MECHANICAL					See Figure 1

Table 1: Pin Assignments

Pin #	Pin Name	Function	Comments
1	-Vo	Negative Output	
2	-RS	Negative Remote Sense	If not used, leave open or short to -Vo
3	Trim	Output Voltage Trim	Refer to page 6
4	+RS	Positive Remote Sense	If not used, leave open or short to +Vo
5	+Vo	Positive Output	
6	-Vin	Negative Input	
7	CHGND	Chassis Ground (Case)	Short to -Vin if no chassis ground is available
8	Key Pin/NC	To Key Converter	Leave as a No Connect pin
9	ON/OFF	Remote On/Off	If not used, leave floating for Active High Unit If not used, short to -Vin on an Active Low Unit
10	+Vin	Positive Input	

Figure 1: Mechanical Dimensions

Unit: inches [mm]

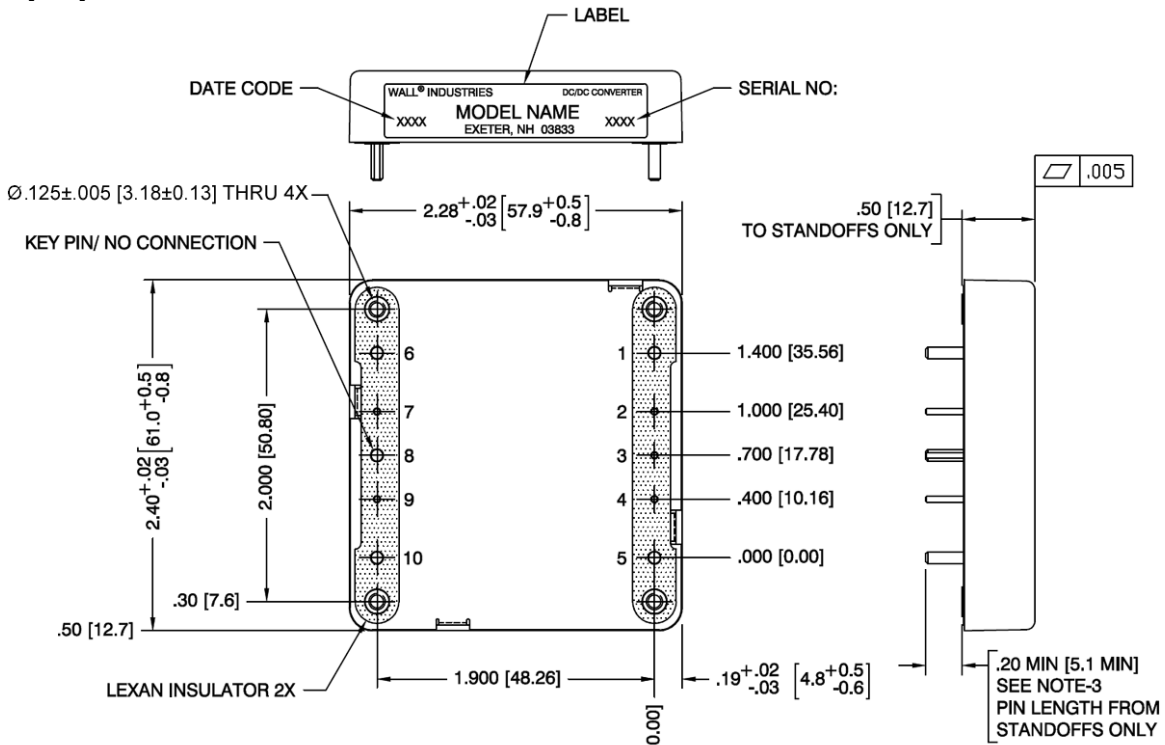

PIN DESIGNATION	PIN Ø
1 -OUTPUT	Ø.081
2 -SENSE	Ø.040
3 TRIM	Ø.040
4 +SENSE	Ø.040
5 +OUT	Ø.081
6 -Vin	Ø.081
7 CASE GRD	Ø.040
8 KEY PIN/NC	Ø.081
9 ON/OFF	Ø.040
10 +Vin	Ø.081

NOTES:

- PIN TO PIN TOLERANCE $\pm .01$ [± 0.3],
PIN DIAMETER TOLERANCE: $\pm .005$ [± 0.13].
- CASE MATERIAL: .040 [1.02] THICK, ALUMINUM ALLOY 3003-0, PER: QQA 250/2.
- UNLESS OTHERWISE SPECIFIED.

TO ORDER:

- UNIT COMES WITH EITHER 3M x 0.5 THREADED THRU INSERTS OR FOR Ø.125 THRU-HOLE ADD: "TH" SUFFIX TO MODEL PART NUMBER. EXAMPLE: LV12S15-100TH
- CONSULT FACTORY FOR OPTIONAL HEAT SINK.

DESIGN CONSIDERATIONS

Under Voltage Lock Out (UVLO)

The converter output is disabled until the input voltage exceeds the UVLO turn-on limit. The converter will remain ON until the input voltage falls below the UVLO turn-off limit.

Over Current Protection

The converter is protected from short circuit and over current conditions. During these fault conditions, the converter output will 'hiccup'. The converter output will recover once the short or over current fault is removed.

Over Temperature Protection (OTP)

The converter has internal thermal protection that will shut the converter OFF once the case temperature exceeds the OTP turn-off limit. The converter will resume operation when the case temperature has dropped below the OTP turn-on limit.

Input Filter

It is recommended to bypass the +V_{in} and -V_{in} pins of the converter with a minimum of 680uF (50V minimum) capacitor (UCC - SXE50VB681M12X35LL). No other bypassing is needed. However, to reduce the input ripple beyond what is seen in Photo 1, larger values of capacitance may be used in conjunction with a ceramic capacitor. Additionally, an inductor may be placed between the source and the previously mentioned capacitor. No inductor should be placed between the capacitor and the input to the converter. It is important to note that placement of the input filter must be as close as possible to the input pins of the converter to assure a low impedance at the pins.

Figure 2: Input Filter Setup

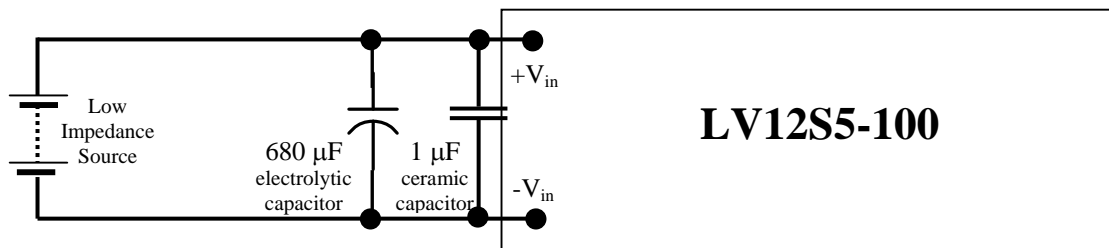

Output Filter

No additional output capacitor is needed for the power supply to operate. However, to reduce the ripple and noise on the output, additional capacitance may be added. A low ESR Ceramic capacitor may be added across the +V_o and -V_o pins to reduce the ripple and spike noise. Additional capacitance in the form of a tantalum or aluminum electrolytic may also be placed across these pins in order to reduce ripple and improve the transient peak-to-peak voltage deviation.

Remote Sense

To improve the regulation at the load, route the connections from the -RS and the +RS pins to the -V_o and +V_o connections at the load. This will force the converter to regulate the voltage at the load and not at the pins of the converter (refer to Graph 8). If it is not desired to use the Remote Sense feature, the -RS and +RS pins may be left open or they may be shorted to the -V_o and +V_o pins respectively. Shorting the RS pins to the V_o pins will reduce the voltage drops through the converter pins.

Remote ON/OFF

The converter has the ability to be remotely turned ON or OFF. The LV series is Active-High. Active-High means that a logic high at the ON/OFF pin will enable the supply (Figure 3). With Active-High, if the ON/OFF pin is left floating, the supply will be enabled.

Figure 3: Active-High

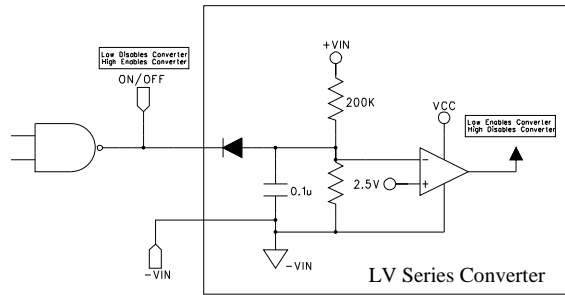

Output Voltage Trim: (5V, 12V, 15V, and 20V Models)

The output is adjustable +/-10% of rated output voltage. To trim the output voltage down, place the trim resistor between the Trim and -Rs pins (Figure 5). To trim the output voltage up, place the trim resistor between the Trim and +Rs pins (Figure 4).

The value of the trim resistor with respect to the desired output voltage (Vo) can be derived from the following formulas, or looked up on the trim table (Table 2).

$$R_{TH} = \frac{R_1 \cdot V_o \cdot \frac{V_{onom}}{U_1}}{V_o - V_{onom}} - \frac{R_1 \cdot V_o}{V_o - V_{onom}} - R_{lim} \quad (\text{in Kohms})$$

$$R_{TL} = \frac{R_1 \cdot V_o}{V_{onom} - V_o} - R_{lim} \quad (\text{in Kohms})$$

Figure 4: Trim Up

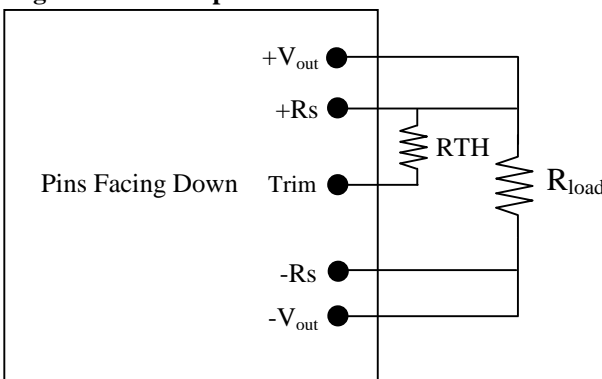

Figure 5: Trim Down

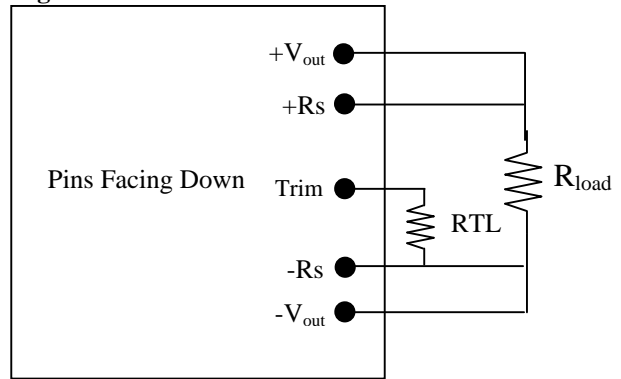

Table 2: Trim Equations for LV Series (5V, 12V, 15V, and 20V Models)

Vonom	U1	R1	Rlim	RTH to +Rs
5.000	2.500	5.11	5.11	RTL to -Rs

Percent Trim	<u>Trim Low</u>		<u>Trim High</u>		All in Kohms
	Vo	RTL	Vo	RTH	
1%	4.950	500.78	5.050	511.00	
2%	4.900	245.28	5.100	255.50	
3%	4.850	160.11	5.150	170.33	
4%	4.800	117.53	5.200	127.75	
5%	4.750	91.98	5.250	102.20	
6%	4.700	74.95	5.300	85.17	
7%	4.650	62.78	5.350	73.00	
8%	4.600	53.66	5.400	63.88	
9%	4.550	46.56	5.450	56.78	
10%	4.500	40.88	5.500	51.10	

Note that while decreasing the output voltage, the maximum output current still remains at 20A, and while increasing the output voltage, the output current is reduced to maintain a total output power at 100 W.

Paralleling Converters

The LV series converters may be paralleled both for redundancy and for higher output current. However, in order to do this, a high-current, low V_f , schottky diode must be placed at the +Vo pin of each supply as shown in Figure 6. To improve sharing, tie the two TRIM pins together. The converters may be trimmed by adding a resistor value from Table 2 from each TRIM pin to $\pm RS$ pin, or alternatively, a single resistor of half the value of Table 2 from the common TRIM pins to the common $\pm RS$ pins.

Figure 6: Paralleling Converters

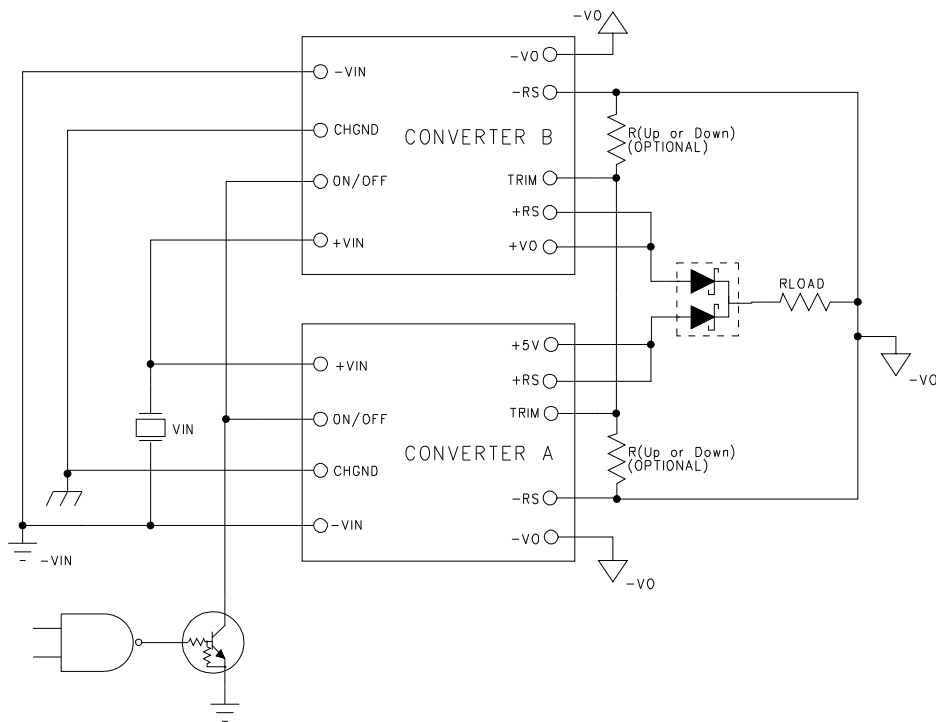

Graph 1: LV12S5-100 Efficiency vs. Output Current

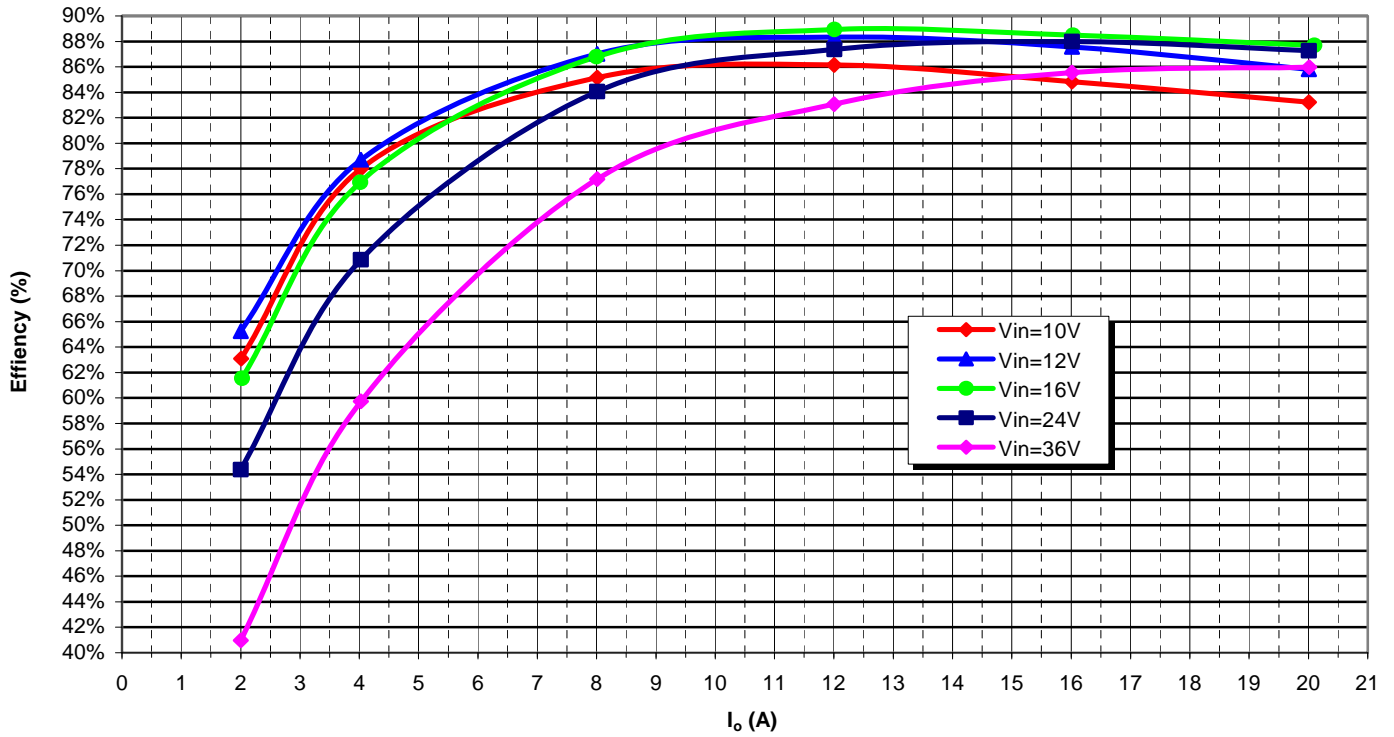

Graph 2: LV12S5-100 Max Ambient vs. I_o

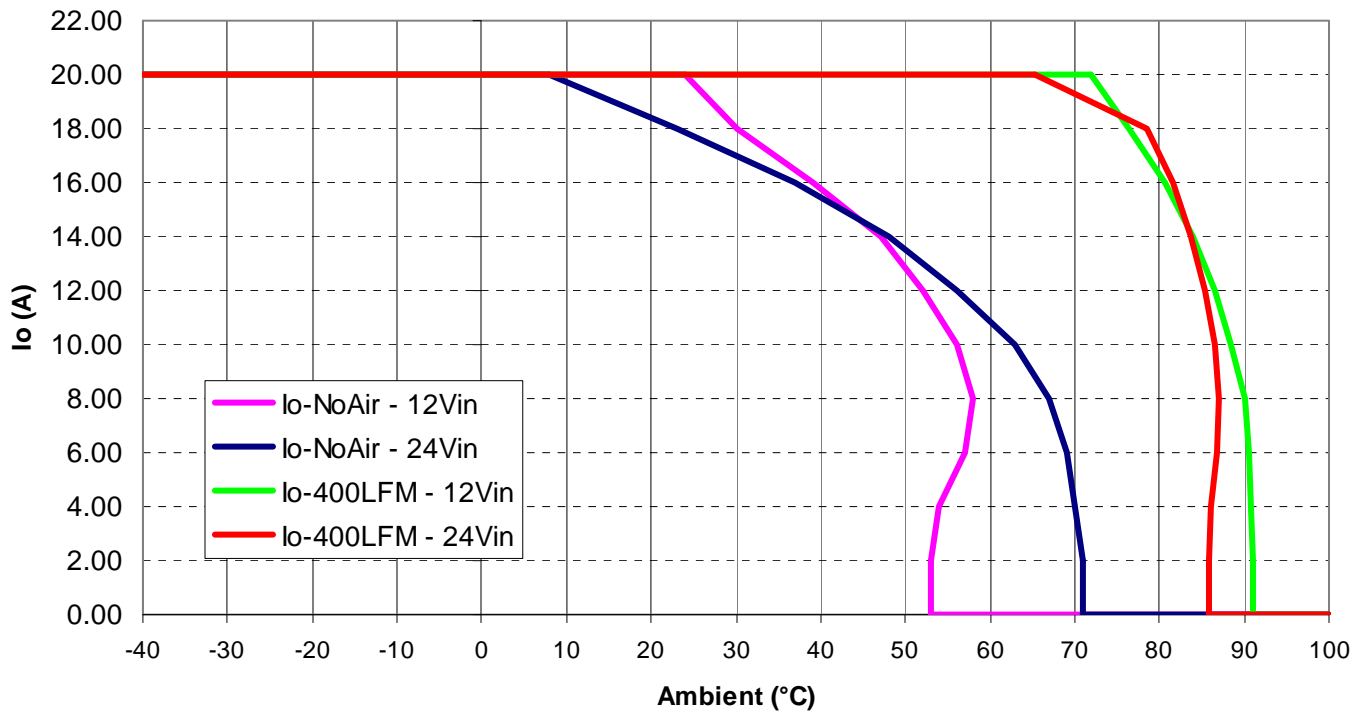

Graph 3: LV12S5-100 Input Current vs. Input Voltage

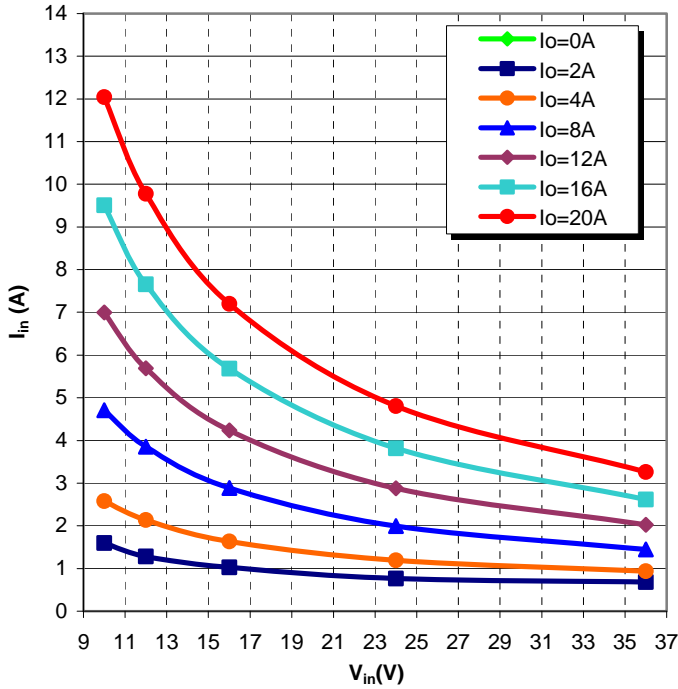

Graph 4: LV12S5-100 Power Dissipation vs. Input Voltage

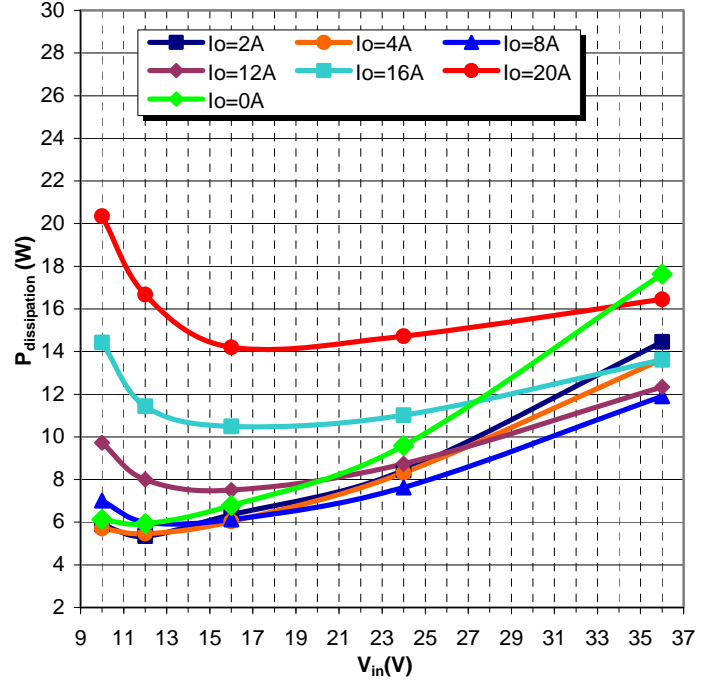

Graph 5: LV12S5-100 No Load Input Current and Power Dissipation vs. Input Voltage

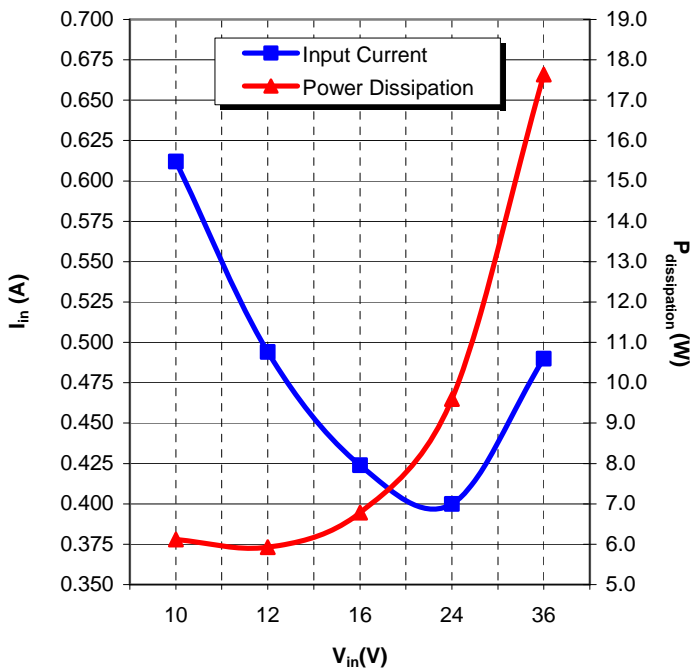

Graph 6: LV12S5-100 "Remote Off" Input Current and Power Dissipation vs. Input Voltage

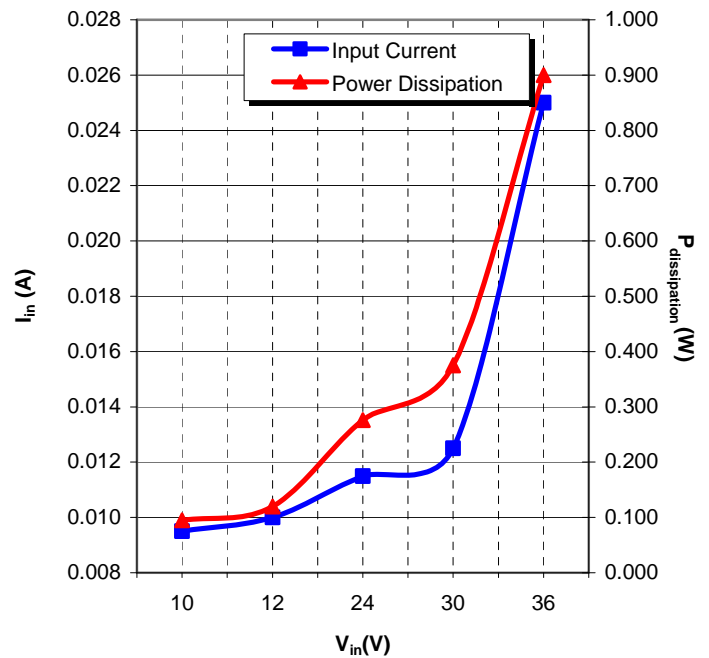

Note: Voltage measurements taken where the output pins are soldered into test board.

Graph 7: LV12S5-100 Load Regulation
(±RS Pins Open)

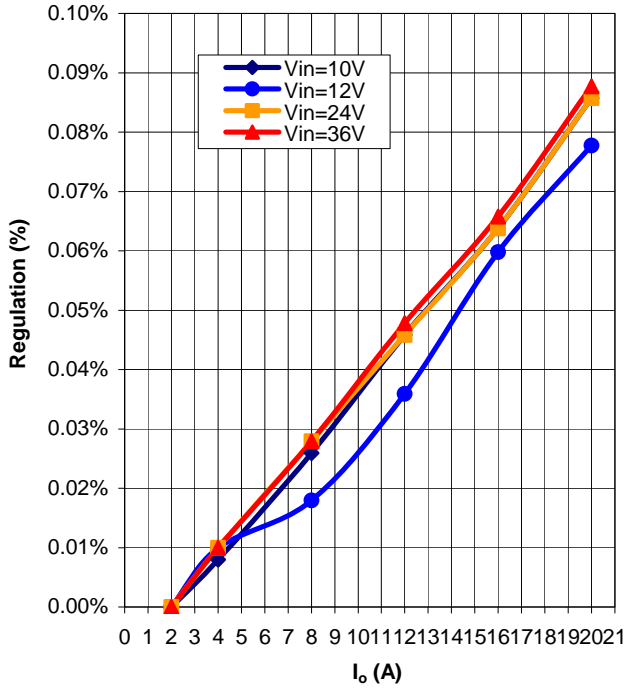

Graph 8: LV12S5-100 Load Regulation
(+RS to +Vo, -RS to -Vo)

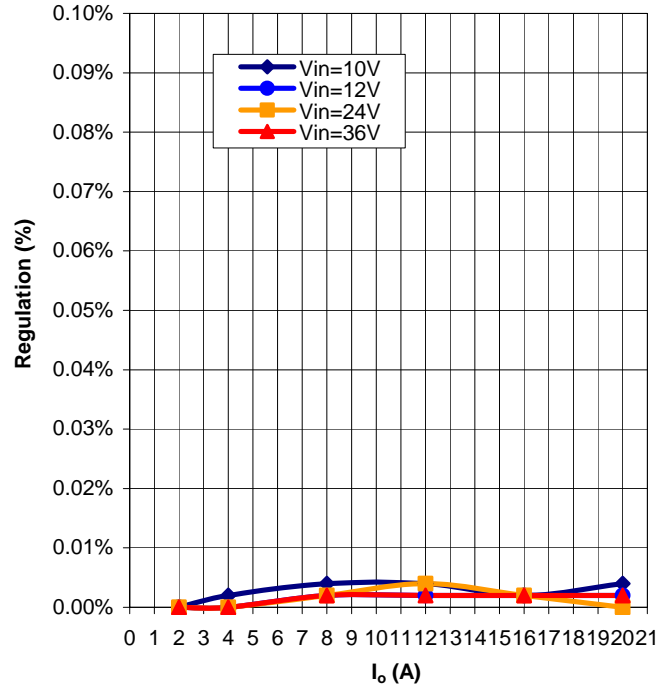

Graph 9: LV12S5-100 Line Regulation
(±RS Pins Open)

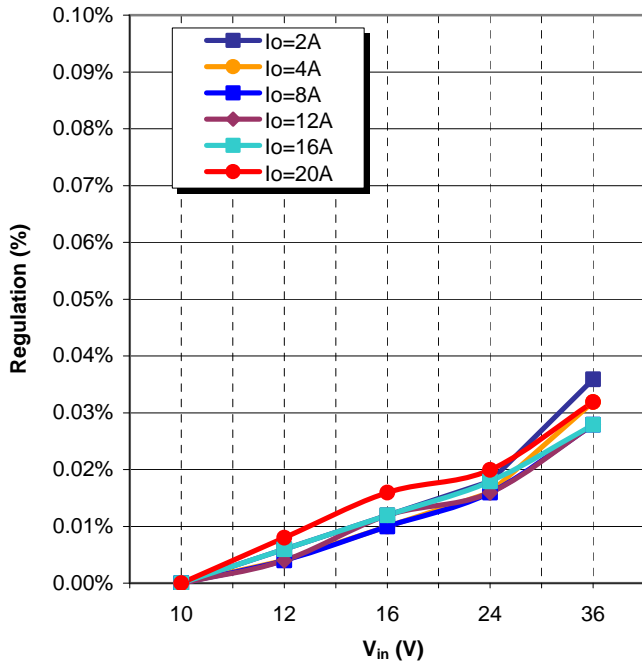

Graph 10: LV12S5-100 Line Regulation
(+RS to +Vo, -RS to -Vo)

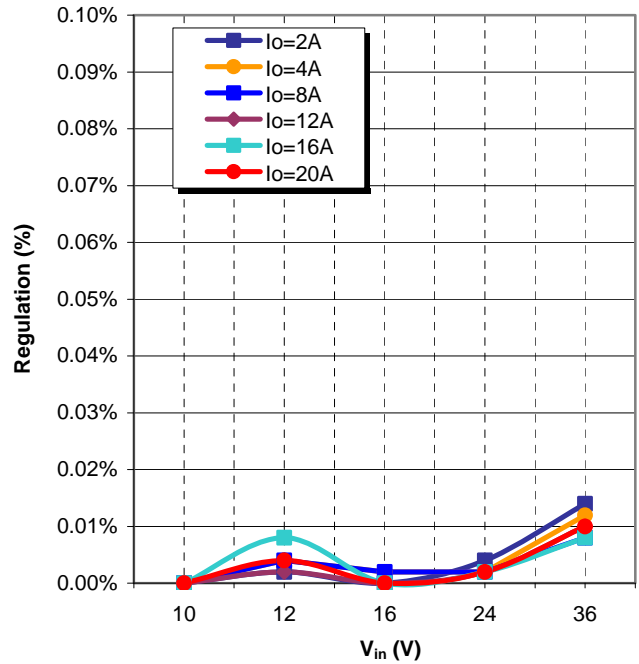

Note: Voltage measurements taken where the output pins are soldered into test board.

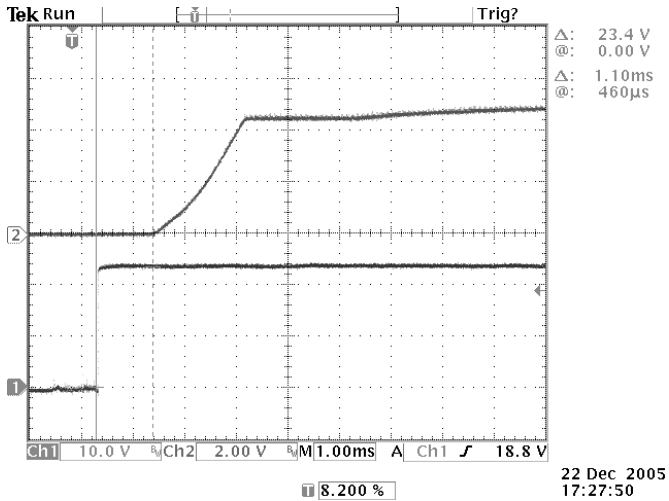

Photo 1: Remote Turn On
Vin=24V, Iout = 2A

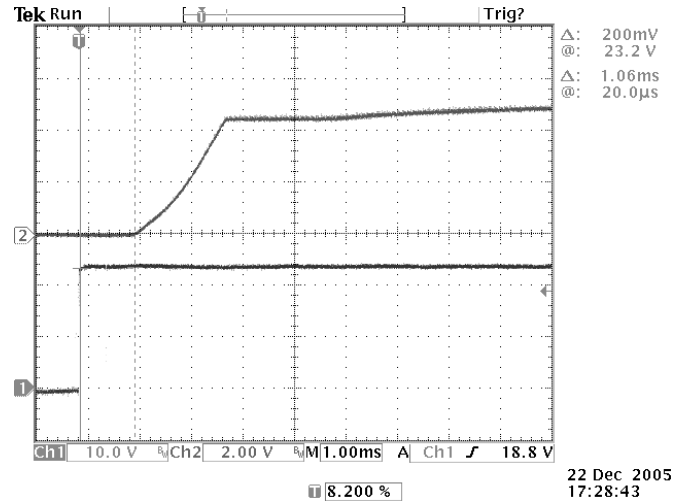

Photo 2: Remote Turn On
Vin=24V, Iout = 20A,

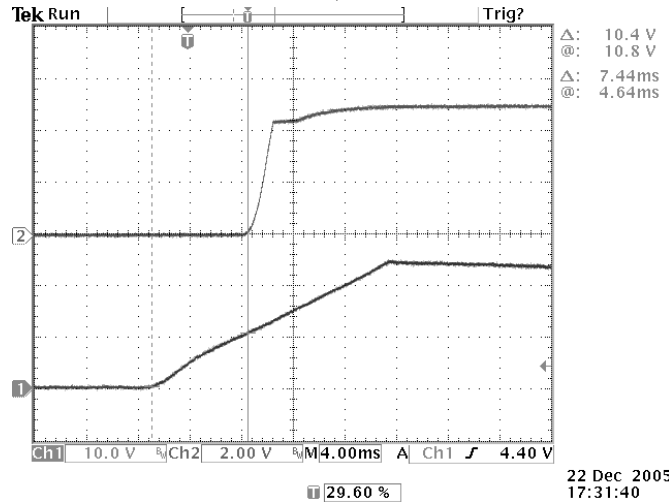

Photo 3: Normal Turn On
Vin=24V, Iout = 2A

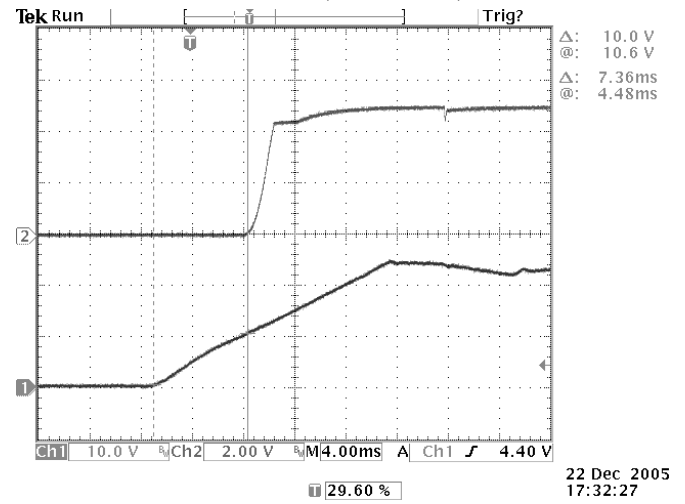

Photo 4: Normal Turn On
Vin=24V, Iout = 20A

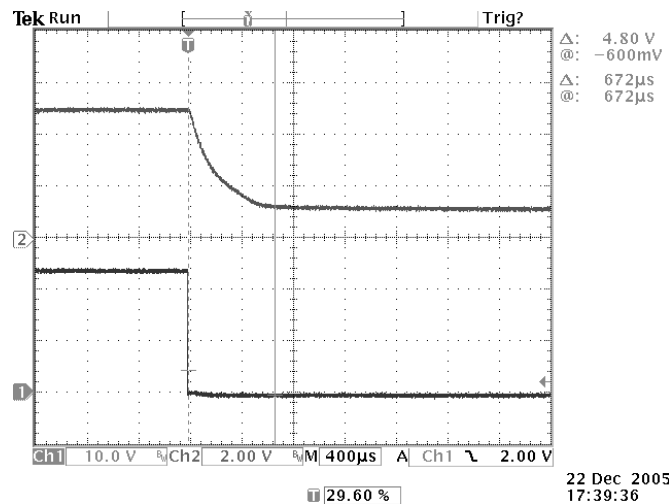

Photo 5: Remote Turn Off
Vin=24V, Iout = 2A

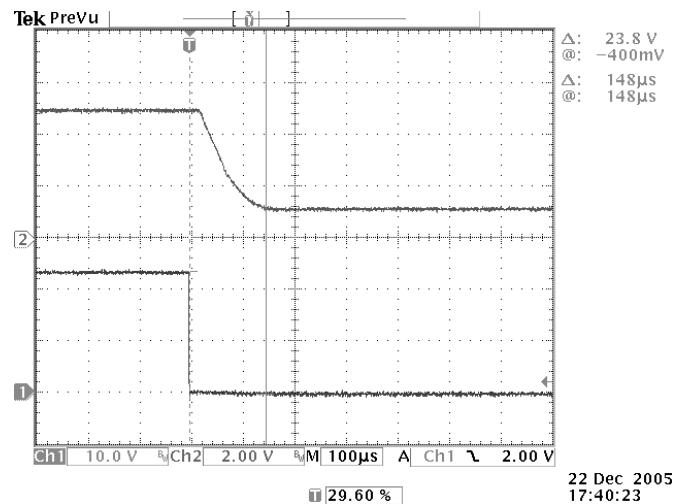
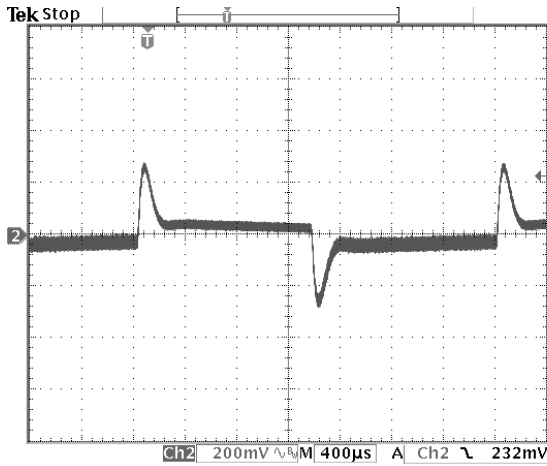
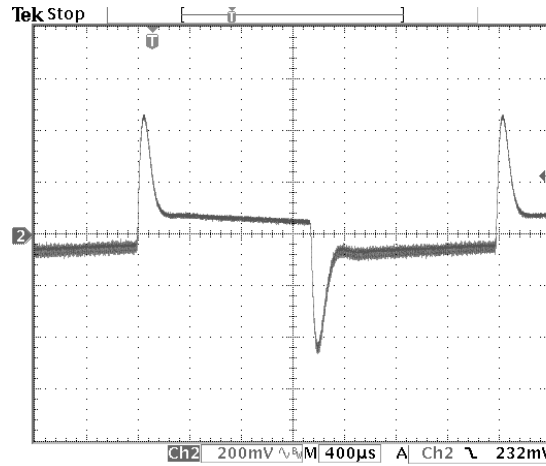

Photo 6: Remote Turn Off
Vin=24V, Iout = 20A



22 Dec 2005
17:49:47

Photo 7: Transient Response 50% to 100%
Vin=24V, Iout = 10 to 20A
Cout=1uF Ceramic + 10uF Tantalum



22 Dec 2005
17:50:20

Photo 8: Transient Response Min Load to Max Load
Vin=24V, Iout = 2 to 20A
Cout=1uF Ceramic + 10uF Tantalum

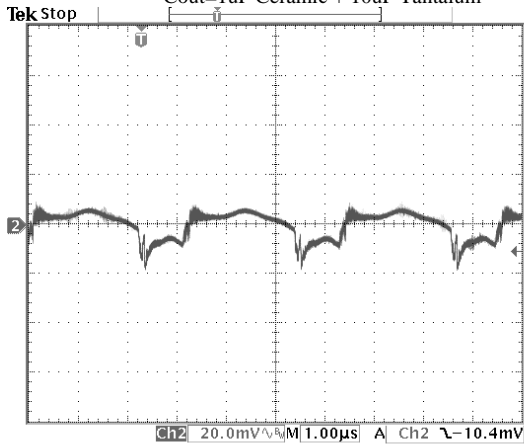

Ch2 Pk-Pk
25.6mV

22 Dec 2005
17:52:06

Photo 9: Output Voltage Ripple (20 MHz BW)
Vin=24V, Iout=1.25A
Cout=1uF Ceramic + 10uF Tantalum

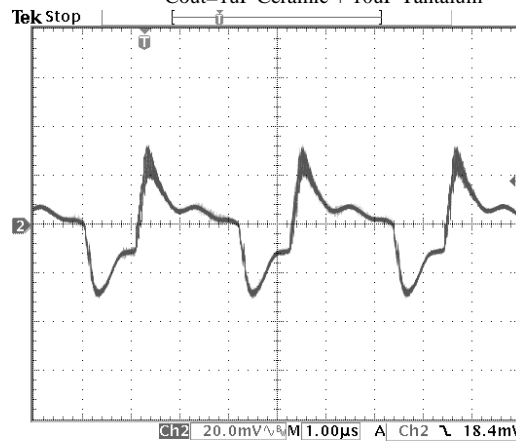

Ch2 Pk-Pk
61.13mV

22 Dec 2005
17:52:50

Photo 10: Output Voltage Ripple (20 MHz BW)
Vin=24V, Iout=20A
Cout=1uF Ceramic + 10uF Tantalum

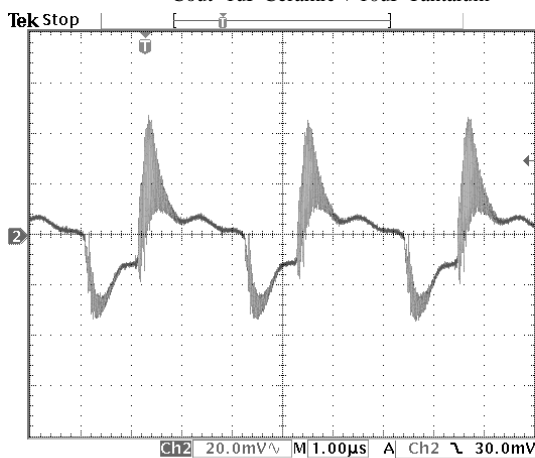

Ch2 Pk-Pk
81.80mV

22 Dec 2005
17:53:35

Photo 11: Output Voltage Ripple (Spike)
Vin=24V, Iout = 20A
Cout=1uF Ceramic + 10uF Tantalum

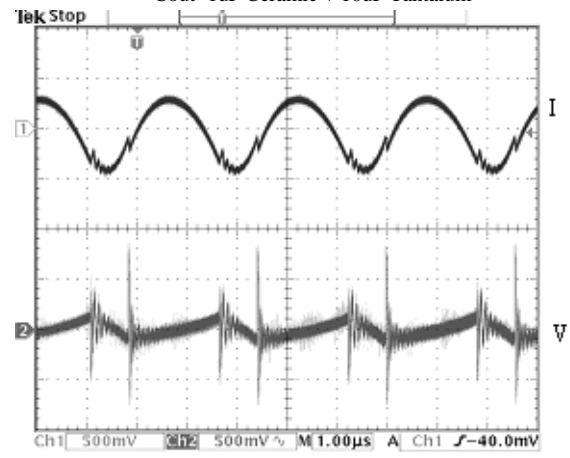

22.80 %

Photo 12: Input Reflected Ripple Voltage and Ripple Current
Vin=24V, Iout = 20A
with a 680uF Aluminum Electrolytic and 12uH series inductor.

TEST SETUP:

The LV12S5-100 specifications are tested with the following configurations:

Regulation and Efficiency Setup

To ensure that accurate measurement are taken, the voltage measurements are taken directly at the terminal of the module. This minimizes errors due to contact and trace lengths between the load and the output of the supply. The following is a diagram of the test setup.

Figure 7: Regulation and Efficiency Probe Setup

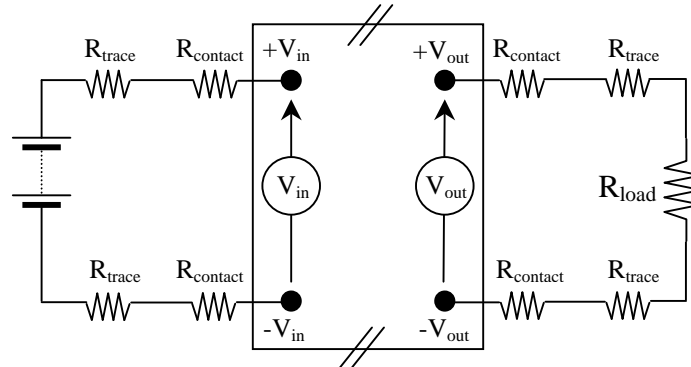

Output Ripple Voltage Setup

The module is tested with a 1uF ceramic capacitor in parallel with a 10uF tantalum capacitor across the output terminals.

Figure 8: Ripple Voltage Probe Setup

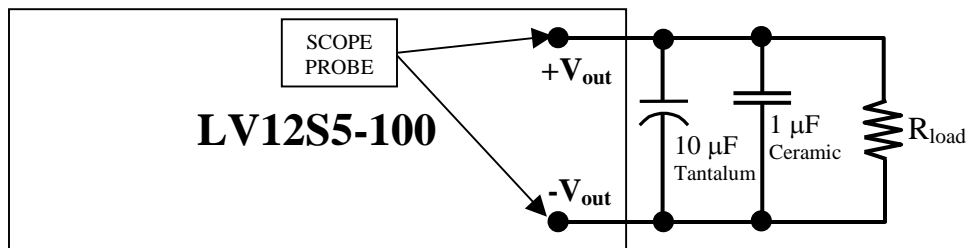

Input Reflected Ripple Current and Input Ripple Current Setup

The module is tested for input reflected ripple current (I_{rrc}) and input ripple current (I_{rc}). The input ripple voltage is also measured at the pins with the following input filter. If there is a need to reduce input ripple current/voltage then additional ceramic capacitors can be added to the input of the converter.

Figure 9: Ripple Current Setup

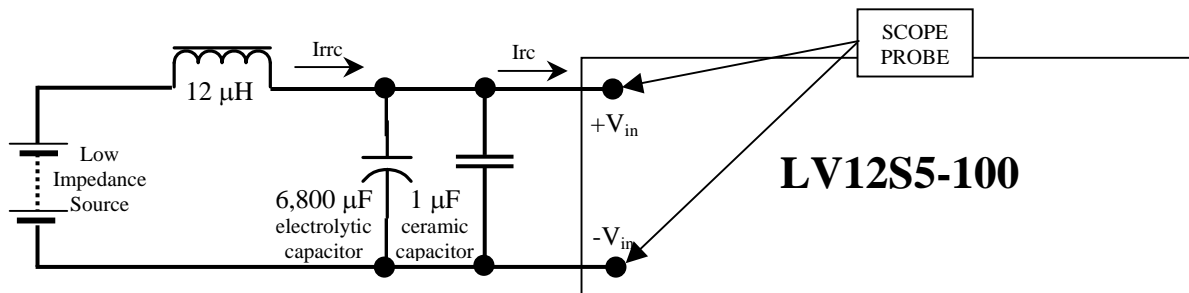

Converter Thermal Consideration

The converter is designed to operate without convective cooling if the derating curves are followed. The converter can operate at higher temperatures if airflow is applied. Airflow should be aligned lengthwise to the converter for optimum heat transfer. Contact Factory for derating curves.

Figure 10: Airflow Orientation

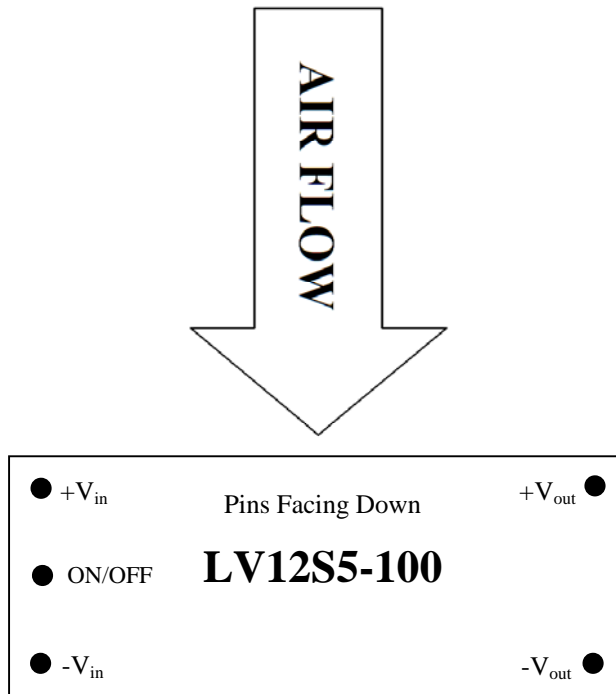

Company Information:

Wall Industries, Inc. has created custom and modified units for over 40 years. Our in-house research and development engineers will provide a solution that exceeds your performance requirements on-time and on budget. Our ISO9001-2008 certification is just one example of our commitment to producing a high quality, well-documented product for our customers.

Our past projects demonstrate our commitment to you, our customer. Wall Industries, Inc. has a reputation for working closely with its customers to ensure each solution meets or exceeds form, fit and function requirements. We will continue to provide ongoing support for your project above and beyond the design and production phases. Give us a call today to discuss your future projects.

Contact **Wall Industries** for further information:

<u>Phone:</u>	☎(603)778-2300
<u>Toll Free:</u>	☎(888)587-9255
<u>Fax:</u>	☎(603)778-9797
<u>E-mail:</u>	sales@wallindustries.com
<u>Web:</u>	www.wallindustries.com
<u>Address:</u>	5 Watson Brook Rd. Exeter, NH 03833