

# User Manual

## FieldForce TCM

High Accuracy Electronic Compass Module





## Table of Contents

<b>1</b>	<b>COPYRIGHT &amp; WARRANTY INFORMATION .....</b>	<b>1</b>
<b>2</b>	<b>INTRODUCTION .....</b>	<b>2</b>
<b>3</b>	<b>SPECIFICATIONS.....</b>	<b>3</b>
3.1	Performance Specifications .....	3
3.2	Operating Characteristics .....	4
3.3	Mechanical Drawing .....	5
<b>4</b>	<b>SET-UP.....</b>	<b>7</b>
4.1	Electrical Connections.....	7
4.2	Installation Location.....	8
4.2.1	Operate within sensors' linear regime .....	8
4.2.2	Locate away from changing magnetic fields .....	8
4.2.3	Mount in a physically stable location .....	8
4.2.4	Location-verification testing.....	8
4.3	Mechanical Mounting.....	9
<b>5</b>	<b>OPERATION WITH TCM STUDIO .....</b>	<b>10</b>
5.1	Installation onto a Windows or Mac System.....	10
5.2	Connection Tab.....	11
5.2.1	Initial Connection.....	11
5.2.2	Changing Baud Rate.....	11
5.2.3	Changing Modules .....	12
5.3	Configuration Tab .....	12
5.3.1	Mounting Options.....	12
5.3.2	North Reference.....	13
5.3.3	Endianess .....	13
5.3.4	Output.....	13
5.3.5	Enable 3D Model.....	14
5.3.6	Filter Setting (Taps).....	14
5.3.7	Acquisition Settings.....	14
5.3.8	HPR During Calibration .....	15
5.3.9	Calibration Settings.....	15
5.3.10	Default.....	16
5.3.11	Retrieve.....	16
5.4	Calibration Tab.....	17
5.4.1	Samples.....	17
5.4.2	Calibration Results .....	18
5.4.3	Current Configuration .....	19
5.4.4	Options.....	19
5.4.5	Clear .....	19
5.5	Test Tab.....	20
5.5.1	Current Reading .....	20

5.5.2	3D Model.....	20
5.5.3	Acquisition Settings.....	20
5.5.4	Sync Mode.....	21
5.6	Data Logger Tab .....	22
5.7	System Log Tab .....	23
5.8	Graph Tab.....	24
<b>6</b>	<b>FIELD CALIBRATION .....</b>	<b>25</b>
6.1	Magnetic Field Calibration Theory.....	26
6.1.1	Hard and Soft Iron Effects.....	26
6.1.2	Pitch and Roll .....	26
6.2	Field Calibration Procedures.....	27
6.2.1	Full Range Calibration .....	28
6.2.2	2D Calibration .....	31
6.2.3	Limited Tilt Range Calibration.....	32
6.2.4	Hard Iron Only Calibration .....	33
6.2.5	Accelerometer Only Calibration .....	33
6.2.6	Mag and Accel Calibration .....	35
6.3	Declination Value .....	35
6.4	Other Considerations.....	35
<b>7</b>	<b>OPERATION WITH PNI BINARY PROTOCOL .....</b>	<b>36</b>
7.1	Datagram Structure .....	36
7.2	Parameter Formats .....	37
7.3	Commands & Communication Frames.....	39
7.4	kGetModInfo (frame ID 1d) .....	40
7.4.1	kModInfoResp (frame ID 2d) .....	40
7.4.2	kSetDataComponents (frame ID 3 <sub>d</sub> ) .....	40
7.4.3	kGetData (frame ID 4 <sub>d</sub> ) .....	42
7.4.4	kDataResp (frame ID 5 <sub>d</sub> ) .....	42
7.4.5	kSetConfig (frame ID 6 <sub>d</sub> ) .....	43
7.4.6	kGetConfig (frame ID 7 <sub>d</sub> ).....	46
7.4.7	kConfigResp (frame ID 8 <sub>d</sub> ).....	46
7.4.8	kSave (frame ID 9 <sub>d</sub> ) .....	46
7.4.9	kStartCal (frame ID 10d) .....	47
7.4.10	kStopCal (frame ID 11d).....	48
7.4.11	kSetParam (frame ID 12 <sub>d</sub> ) .....	48
7.4.12	kGetParam (frame ID 13 <sub>d</sub> ).....	50
7.4.13	kParamResp (frame ID 14 <sub>d</sub> ).....	50
7.4.14	kPowerDown (frame ID 15 <sub>d</sub> ) .....	50
7.4.15	kSaveDone (frame ID 16 <sub>d</sub> ).....	50
7.4.16	kUserCalSampCount (frame ID 17 <sub>d</sub> ).....	51
7.4.17	kUserCalScore (frame ID 18 <sub>d</sub> ).....	51
7.4.18	kSetConfigDone (frame ID 19 <sub>d</sub> ).....	52
7.4.19	kSetParamDone (frame ID 20 <sub>d</sub> ).....	52

7.4.20	kStartIntervalMode (frame ID 21 <sub>d</sub> ) .....	52
7.4.21	kStopIntervalMode (frame ID 22 <sub>d</sub> ).....	52
7.4.22	kPowerUp (frame ID 23 <sub>d</sub> ) .....	52
7.4.23	kSetAcqParams (frame ID 24 <sub>d</sub> ).....	52
7.4.24	kGetAcqParams (frame ID 25 <sub>d</sub> ) .....	53
7.4.25	kAcqParamsDone (frame ID 26 <sub>d</sub> ) .....	54
7.4.26	kAcqParamsResp (frame ID 27 <sub>d</sub> ) .....	54
7.4.27	kPowerDownDone (frame ID 28 <sub>d</sub> ).....	54
7.4.28	kFactoryUserCal (frame ID 29 <sub>d</sub> ).....	54
7.4.29	kFactoryUserCalDone (frame ID 30 <sub>d</sub> ) .....	54
7.4.30	kTakeUserCalSample (frame ID 31 <sub>d</sub> ) .....	54
7.4.31	kFactoryInclCal (frame ID 36 <sub>d</sub> ).....	54
7.4.32	kFactoryInclCalDone (frame ID 37 <sub>d</sub> ).....	54
7.4.33	kSetMode (frame ID 46 <sub>d</sub> ).....	55
7.4.34	kSetModeResps (frame ID 47 <sub>d</sub> ) .....	55
7.4.35	kSyncRead (frame ID 49 <sub>d</sub> ).....	56
7.5	Code Examples .....	57
7.5.1	Header File & CRC-16 Function.....	57
7.5.2	CommProtocol.h File .....	60
7.5.3	CommProtocol.cpp File.....	62
7.5.4	TCM.h File .....	66
7.5.5	TCM.cpp File.....	67

## List of Tables

Table 3-1: Performance Specifications	3
Table 3-2: I/O Characteristics	4
Table 3-3: Power Requirements	4
Table 3-4: Environmental Requirements	4
Table 3-5: Mechanical Characteristics	5
Table 4-1: TCM Pin Descriptions	7
Table 5-1: Mounting Orientations	13
Table 6-1: Calibration Mode Summary	27
Table 6-2: 12 Point North-Unaware Calibration Pattern	30
Table 6-3: 18 Point North-Aware Calibration Pattern	31
Table 6-4: 12 Point 2D Calibration Pattern	32
Table 6-5: 12 Point Limited Tilt Calibration Pattern	32
Table 6-6: 6 Point Hard Iron Only Calibration Pattern	33
Table 6-7: 18 Point Accelerometer Calibration Pattern	34
Table 7-1: UART Configuration	36
Table 7-2: Command Set	39
Table 7-3: Component Identifiers	41
Table 7-4: Configuration Identifiers	43
Table 7-5: Sample Points	45
Table 7-6: Recommended FIR Filter Tap Values	49

## List of Figures

Figure 3-1: TCM XB Mechanical Drawing	5
Figure 3-2: TCM MB Mechanical Drawing	6
Figure 3-3: PNI Pigtailed Cable Drawing	6
Figure 4-1: Mounting Orientations	9
Figure 6-1: Positive & Negative Roll and Pitch Definition	27
Figure 6-2: Full Range Calibration with 12 Point North-Unaware Cal. Pattern	29
Figure 6-3: Full Range Calibration with 18 Point North-Aware Cal. Pattern	30
Figure 6-4: Accelerometer Calibration Starting Orientations	34
Figure 7-1: Datagram Structure	36

---

# 1 Copyright & Warranty Information

© Copyright PNI Sensor Corporation 2009

All Rights Reserved. Reproduction, adaptation, or translation without prior written permission is prohibited, except as allowed under copyright laws.

Revised May 2011. For most recent version visit our website at [www.pnicorp.com](http://www.pnicorp.com)

PNI Sensor Corporation  
133 Aviation Blvd, Suite 101  
Santa Rosa, CA 95403, USA  
Tel: (707) 566-2260  
Fax: (707) 566-2261

**Warranty and Limitation of Liability.** PNI Sensor Corporation ("PNI") manufactures its TCM products ("Products") from parts and components that are new or equivalent to new in performance. PNI warrants that each Product to be delivered hereunder, if properly used, will, for one year following the date of shipment unless a different warranty time period for such Product is specified: (i) in PNI's Price List in effect at time of order acceptance; or (ii) on PNI's web site ([www.pnicorp.com](http://www.pnicorp.com)) at time of order acceptance, be free from defects in material and workmanship and will operate in accordance with PNI's published specifications and documentation for the Product in effect at time of order. PNI will make no changes to the specifications or manufacturing processes that affect form, fit, or function of the Product without written notice to the OEM, however, PNI may at any time, without such notice, make minor changes to specifications or manufacturing processes that do not affect the form, fit, or function of the Product. This warranty will be void if the Products' serial number, or other identification marks have been defaced, damaged, or removed. This warranty does not cover wear and tear due to normal use, or damage to the Product as the result of improper usage, neglect of care, alteration, accident, or unauthorized repair.

THE ABOVE WARRANTY IS IN LIEU OF ANY OTHER WARRANTY, WHETHER EXPRESS, IMPLIED, OR STATUTORY, INCLUDING, BUT NOT LIMITED TO, ANY WARRANTY OF MERCHANTABILITY, FITNESS FOR ANY PARTICULAR PURPOSE, OR ANY WARRANTY OTHERWISE ARISING OUT OF ANY PROPOSAL, SPECIFICATION, OR SAMPLE. PNI NEITHER ASSUMES NOR AUTHORIZES ANY PERSON TO ASSUME FOR IT ANY OTHER LIABILITY.

If any Product furnished hereunder fails to conform to the above warranty, OEM's sole and exclusive remedy and PNI's sole and exclusive liability will be, at PNI's option, to repair, replace, or credit OEM's account with an amount equal to the price paid for any such Product which fails during the applicable warranty period provided that (i) OEM promptly notifies PNI in writing that such Product is defective and furnishes an explanation of the deficiency; (ii) such Product is returned to PNI's service facility at OEM's risk and expense; and (iii) PNI is satisfied that claimed deficiencies exist and were not caused by accident, misuse, neglect, alteration, repair, improper installation, or improper testing. If a Product is defective, transportation charges for the return of the Product to OEM within the United States and Canada will be paid by PNI. For all other locations, the warranty excludes all costs of shipping, customs clearance, and other related charges. PNI will have a reasonable time to make repairs or to replace the Product or to credit OEM's account. PNI warrants any such repaired or replacement Product to be free from defects in material and workmanship on the same terms as the Product originally purchased.

Except for the breach of warranty remedies set forth herein, or for personal injury, PNI shall have no liability for any indirect or speculative damages (including, but not limited to, consequential, incidental, punitive and special damages) relating to the use of or inability to use this Product, whether arising out of contract, negligence, tort, or under any warranty theory, or for infringement of any other party's intellectual property rights, irrespective of whether PNI had advance notice of the possibility of any such damages, including, but not limited to, loss of use, revenue or profit. In no event shall PNI's total liability for all claims regarding a Product exceed the price paid for the Product. PNI neither assumes nor authorizes any person to assume for it any other liabilities.

Some states and provinces do not allow limitations on how long an implied warranty lasts or the exclusion or limitation of incidental or consequential damages, so the above limitations or exclusions may not apply to you. This warranty gives you specific legal rights and you may have other rights that vary by state or province.

---

## 2 Introduction

Thank you for purchasing PNI Sensor Corporation's FieldForce TCM XB (pn 12810) or FieldForce TCM MB (pn 13095) tilt-compensated 3-axis digital compass. The TCM is a high-performance, low-power consumption, tilt-compensated electronic compass module that incorporates PNI's advanced magnetic distortion compensation and calibration scoring algorithms to provide industry-leading heading accuracy. The TCM combines PNI's patented magneto-inductive sensors and measurement circuit technology with a 3-axis MEMS accelerometer for unparalleled cost effectiveness and performance.

PNI recognizes not all applications allow for significant tilt during calibration, so multiple calibration methods are available to ensure optimized performance can be obtained in the real world. These include Full Range Calibration, when  $\geq 45^\circ$  of tilt is possible during calibration, 2D Calibration when constrained to calibration in a horizontal or near-horizontal plane, and Limited Tilt Calibration when tilt is constrained to  $< 45^\circ$  but  $> 5^\circ$  of tilt is possible.

PNI also recognizes conditions may change over time, and to maintain superior heading accuracy it may be necessary to recalibrate the compass. So the TCM incorporates Hard Iron Only Calibration to easily account for gradual changes in the local magnetic distorting components. And the accelerometers can be recalibrated in the field if desired.

These advantages make PNI's TCM the choice for applications that require the highest accuracy and performance anywhere in the world under a wide range of conditions. Applications for the TCM include:

- Unmanned vehicles – underwater (UUV), ground (UGV), & aerial (UAV)
- Far target locaters and laser range finders
- Dead reckoning systems
- Systems in which the tilt angles used for calibration are physically constrained

With its many applications, the TCM incorporates a flexible and adaptable command set. Many parameters are user-programmable, including reporting units, a wide range of sampling configurations, output damping, and more.

We're sure the TCM will help you to achieve the greatest performance from your system. Thank you for selecting the TCM.



## 3 Specifications

### 3.1 Performance Specifications

Table 3-1: Performance Specifications<sup>1</sup>

Parameter		Value		
Heading	Accuracy	≤65° of tilt after full range calibration	<0.3° rms	
		≤80° of tilt after full range calibration	<0.5° rms	
		≤5° of tilt after 2D calibration	<2.0° rms	
		≤2 times the calibration tilt angle when using limited-tilt calibration <sup>2</sup>	<2.0° rms	
	Resolution	0.1°		
	Repeatability	0.05° rms		
Tilt (Pitch & Roll)	Range	Pitch	± 90°	
		Roll	± 180°	
	Accuracy	Pitch	0.2° rms	
		Roll	≤65° of pitch	0.2° rms
			≤80° of pitch	0.4° rms
		≤86° of pitch	1.0° rms	
	Resolution	0.01°		
Repeatability	0.05° rms			
Maximum Operational Dip Angle <sup>3</sup>		85°		
Magnetometers	Calibrated Field Range		± 125 μT	
	Resolution		0.05 μT	
	Repeatability		± 0.1 μT	

#### Footnotes:

1. Specifications are subject to change. Assumes the TCM is motionless and the local magnetic field is clean relative to the calibration.
2. For example, if the calibration was performed over ±10° of tilt, then the TCM would provide <2° rms accuracy over ±20° of tilt.
3. Performance at maximum operational dip angle will be somewhat degraded.

## 3.2 Operating Characteristics

**Table 3-2: I/O Characteristics**

Parameter		Value
Communication Interface	TCM XB	Binary RS232 UART
	TCM MB	Binary CMOS/TTL UART
Communication Rate		300 to 115200 baud
Maximum Sample Rate <sup>1</sup>		≈30 samples/sec
Time to Initial Good Data <sup>2</sup>	Initial power up	<210 ms
	Sleep mode recovery	<80 ms

**Footnotes:**

1. The maximum sample rate is dependent on the strength of the magnetic field, and typically will be from 25 to 32 samples/sec.
2. FIR taps set to "0".

**Table 3-3: Power Requirements**

Parameter		Value	
Supply Voltage	TCM XB	3.6 to 5 VDC (unregulated)	
	TCM MB	3.3 to 5 VDC (unregulated)	
Average Current Draw	TCM XB	@ max. sample rate	20 mA typical
		@ 8 Hz sample rate	16 mA typical
	TCM MB	@ max. sample rate	17 mA typical
		@ 8 Hz sample rate	13 mA typical
Peak Current Draw	During application of external power	120 mA pk, 60 mA avg over 2 ms	
	During logical power up/down or Sync Trigger	100 mA pk, 60 mA avg over 4 ms	
Sleep Mode Current Draw		0.3 mA typical	

**Table 3-4: Environmental Requirements**

Parameter	Value
Operating Temperature <sup>1</sup>	-40C to +85C
Storage Temperature	-40C to +85C

**Footnote:**

1. To meet performance specifications, recalibration may be necessary as temperature varies.

**Table 3-5: Mechanical Characteristics**

Parameter		Value
Dimensions (l x w x h)	TCM XB	3.5 x 4.3 x 1.3 cm
	TCM MB	3.3 x 3.1 x 1.3 cm
Weight	TCM XB	6.8 gm
	TCM MB	5.3 gm
Connector	TCM XB	9-pin Molex, pn 53780-0970
	TCM MB	4-pin MIL-MAX, pn 850-10-004-10-001000
Mounting Options		Screw mounts/standoffs, horizontal or vertical

### 3.3 Mechanical Drawing

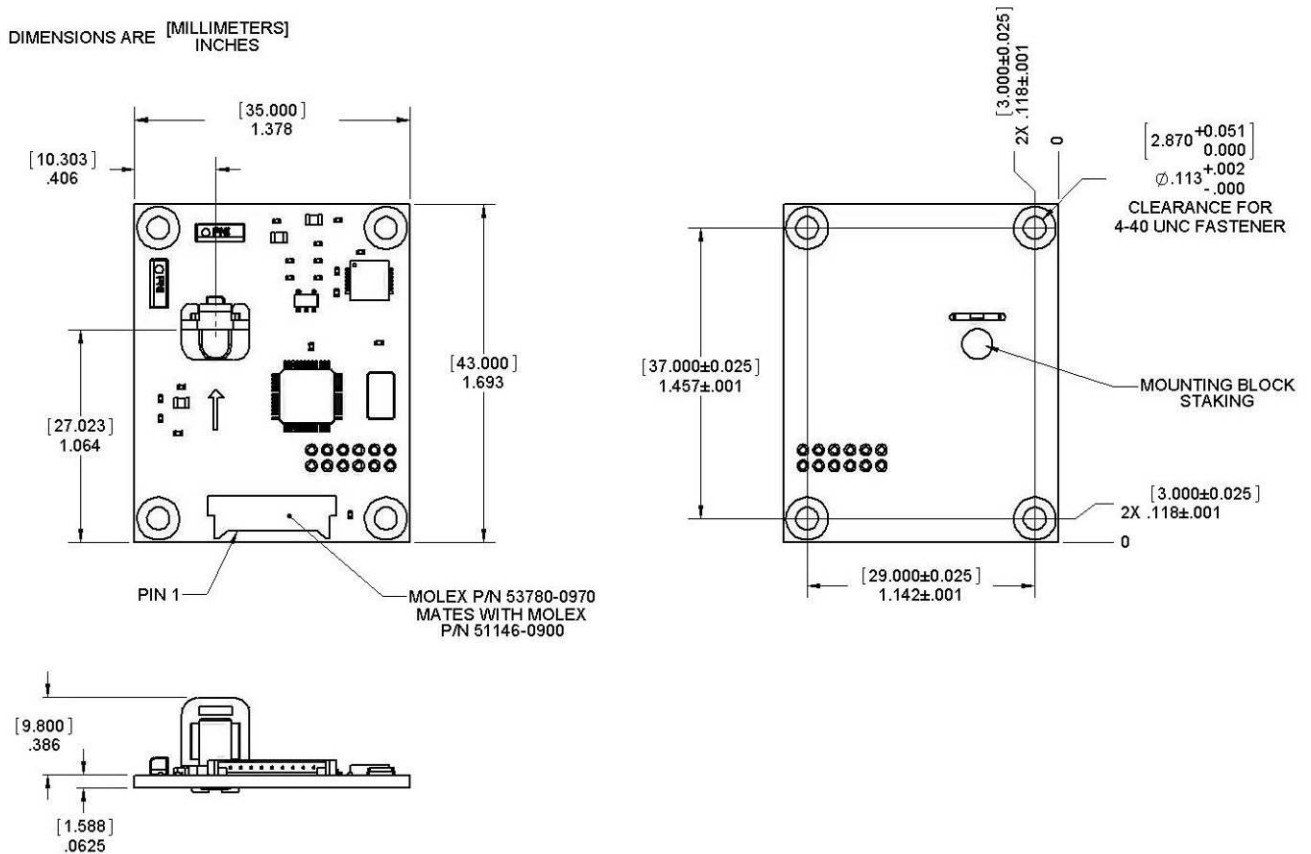

The default orientation for the TCM is for the silk-screened arrow to point in the “forward” direction.

*Figure 3-1: TCM XB Mechanical Drawing*

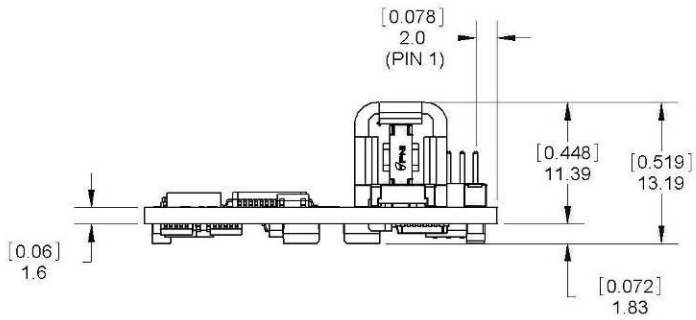
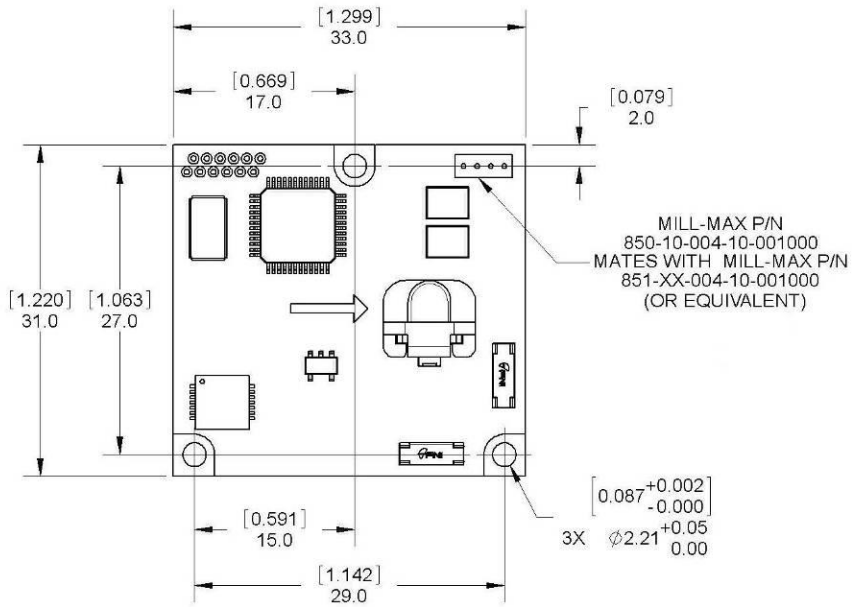

The default orientation for the TCM is for the silk-screened arrow to point in the “forward” direction.

Figure 3-2: TCM MB Mechanical Drawing

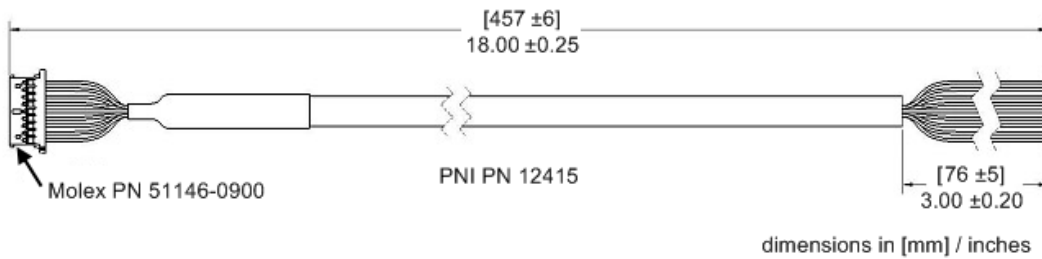

Figure 3-3: PNI Pigtailed Cable Drawing

---

## 4 Set-Up

This section describes how to configure the TCM in your host system. To install the TCM into your system, follow these steps:

- Make electrical connections to the TCM
- Evaluate the TCM using TCM Studio (TCM XB only) or a terminal emulation program, such as HyperTerminal, to ensure the compass generally works correctly
- Choose a mounting location
- Mechanically mount the TCM in the host system
- Perform a field calibration

---

### 4.1 Electrical Connections

The TCM XB incorporates a 9 pin Molex connector, part number 53780-0970, which mates with Molex part 51146-0900 or equivalent. The TCM MB incorporates a 4 pin Mil-Max connector, part number 850-10-004-10-001000, which mates with Mill-Max part 851-XX-004-10-001000 or equivalent. The pin-out is given below in Table 4-1.

**Table 4-1: TCM Pin Descriptions**

Pin Number <sup>1</sup>	TCM XB		TCM MB 4 Pin Connector*
	9 Pin Connector	Pigtailed Cable Wire Color	
1	GND	Black	GND
2	GND	Gray	+5 VDC
3	GND	Green	UART Tx
4	NC	Orange	UART Rx
5	NC	Violet	
6	NC	Brown	
7	UART Tx	Yellow	
8	UART Rx	Blue	
9	+5 VDC	Red	

**Footnote:**

1. For the TCM XB, pin #1 is indicated on Figure 3-1. For the TCM MB, pin #1 is the pin closest to the corner.

After making the electrical connections, it is a good idea to perform some simple tests to ensure the TCM is working as expected. See Section 5 for how to operate the TCM XB with TCM Studio or Section 7 for how to operate the TCM XB or TCM MB via the UART and PNI binary protocol.

---

## 4.2 Installation Location

The TCM's wide dynamic range and sophisticated calibration algorithms allow it to operate in many environments. For optimal performance however, you should mount the TCM with the following considerations in mind:

---

### 4.2.1 Operate within sensors' linear regime

The TCM can be field calibrated to correct for large static magnetic fields created by the host system. However, each axis of the TCM has a maximum calibrated dynamic range of  $\pm 125 \mu\text{T}$ : if the total field exceeds this value for any axis, the TCM may not give accurate heading information. When mounting the TCM, consider the effect of any sources of magnetic fields in the host environment that, when added to the earth's field, may take the sensors out of their linear regime. For example, large masses of ferrous metals such as transformers and vehicle chassis, large electric currents, permanent magnets such as electric motors, and so on.

---

### 4.2.2 Locate away from changing magnetic fields

It is not possible to calibrate for changing magnetic anomalies. Thus, for greatest accuracy, keep the TCM away from sources of local magnetic distortion that will change with time; such as electrical equipment that will be turned on and off, or ferrous bodies that will move. Make sure the TCM is not mounted close to cargo or payload areas that may be loaded with large sources of local magnetic fields.

---

### 4.2.3 Mount in a physically stable location

Choose a location that is isolated from excessive shock, oscillation, and vibration. The TCM works best when stationary. Any non-gravitational acceleration results in a distorted reading of Earth's gravitational vector, which affects the heading measurement.

---

### 4.2.4 Location-verification testing

Location-verification testing should be performed at an early stage of development to understand and accommodate the magnetic distortion contributors in a host system.

#### **Determine the distance range of field distortion.**

Place the compass in a fixed position, then move or energize suspect components while observing the output to determine when they are an influence.

## Determine if the maximum field is within the linear range of the compass.

With the compass mounted, rotate and tilt the system in as many positions as possible. While doing so, monitor the magnetometer outputs, observing if the maximum linear range is exceeded.

### 4.3 Mechanical Mounting

Refer to Section 3.3 for dimensions, hole locations, and the reference frame orientation.

The TCM is factory calibrated with respect to its mounting holes. It must be aligned within the host system with respect to these mounting holes. Ensure any stand-offs or screws used to mount the module are non-magnetic.

The TCM can be mounted in various orientations, as shown in Figure 4-1. All reference points are based on the white silk-screened arrow on the top side of the board. The orientation should be programmed in the TCM using the `kSetConfig` command and the `kMountingRef` setting, as described in Section 7.4.5

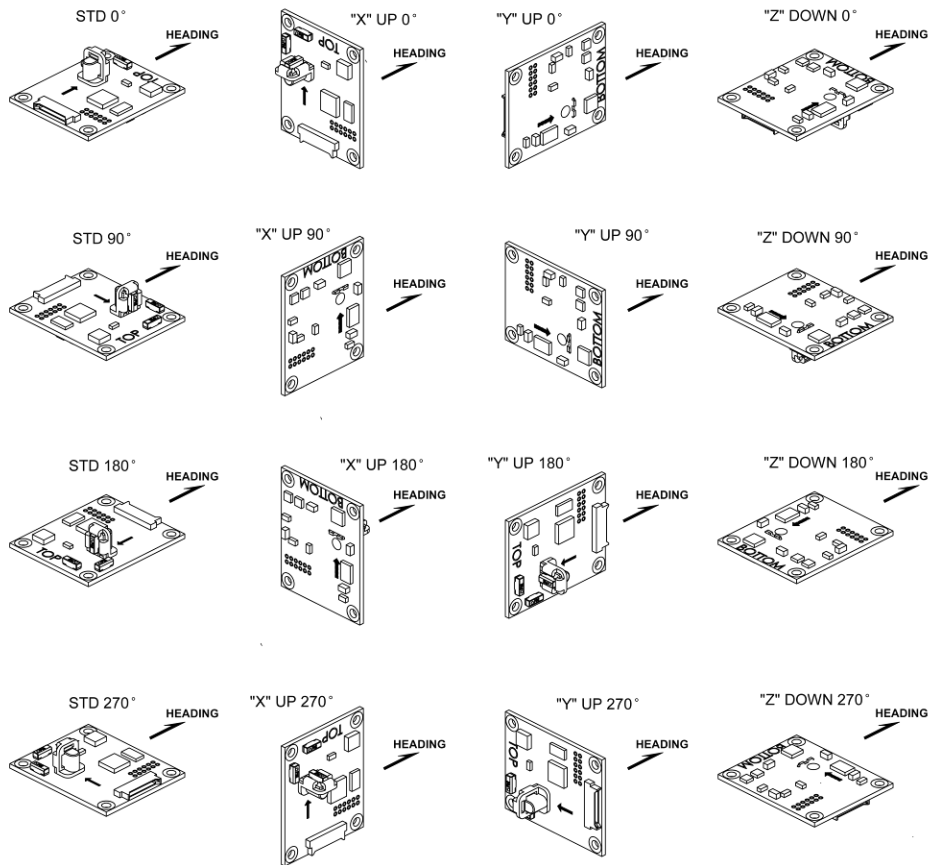

Note that the Z axis sensor and Molex connector are on the top surface of the module.

Figure 4-1: Mounting Orientations

---

## 5 Operation with TCM Studio

The TCM Studio evaluation software communicates with the TCM XB through the RS232 serial port of a computer. The TCM MB is not compatible with TCM Studio because it is not compatible with an RS232-protocol serial port.

TCM Studio puts an easy-to-use, graphical-user interface (GUI) onto the binary command language used by the TCM. Instead of manually issuing command codes, the user can use buttons, check boxes, and dialog boxes to control the TCM and obtain data. It reads the binary responses of the TCM output and formats this into labeled and easy-to-read data fields. TCM Studio also includes the ability to log and save the outputs of the TCM to a file. All of this allows you to begin understanding the capabilities of the TCM while using the TCM Studio program's friendly interface. Anything that can be performed using TCM Studio can also be performed using the RS232 interface and associated protocol. Check the PNI website for the latest TCM Studio updates at [www.pnicorp.com](http://www.pnicorp.com).

---

*Note: TCM Studio version 3.X is compatible with the TCM XB and the legacy TCM 6, but not other legacy TCM models. Conversely, legacy TCM Studio programs will not function properly with the TCM XB. The TCM XB model is the current RS232-version TCM with PNI's binary communication protocol. The version number of TCM Studio is identified in the upper left corner of the GUI.*

---

### 5.1 Installation onto a Windows or Mac System

TCM Studio is provided as an executable program which can be downloaded from PNI's website. It will work with Windows XP, Windows Vista, Windows 7, and Mac OS X operating systems. Check the PNI web page at [www.pnicorp.com](http://www.pnicorp.com) for the latest version.

For Windows computers, copy the TCMStudio.msi file onto your computer. Then, open the file and step through the Setup Wizard.

For Mac computers, copy the TCMStudio.zip file onto your computer. This automatically places the application in the working directory of your computer. The Quesa plug-in, also in the .zip file, needs to be moved to /Library/CFMSupport, if it is not already there.



---

## 5.2 Connection Tab

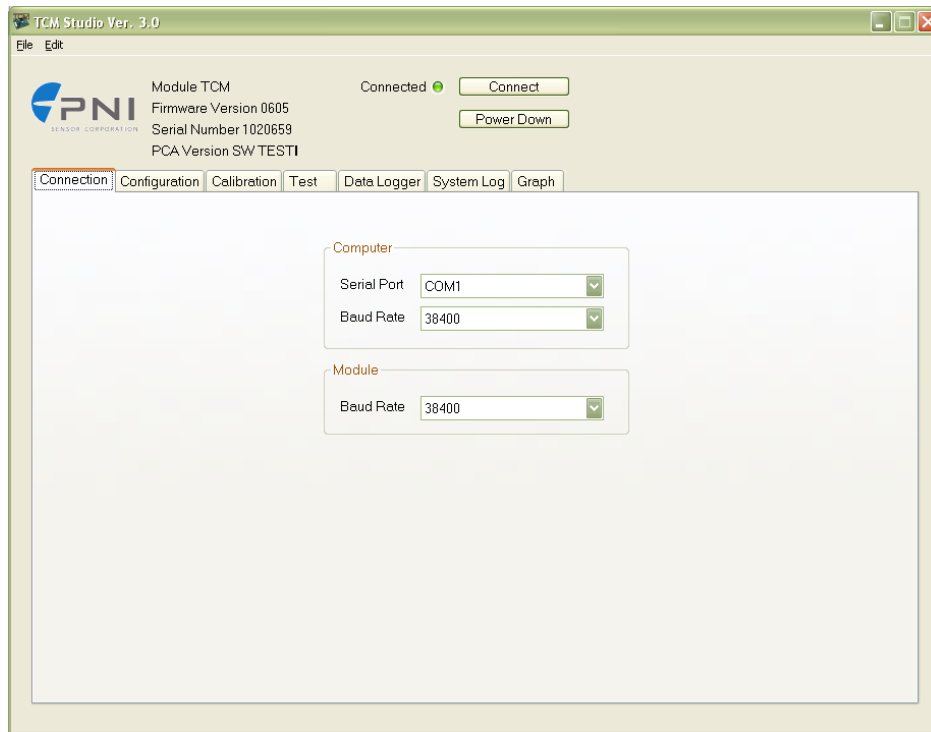

---

### 5.2.1 Initial Connection

If using the PNI dual-connectorized cable, ensure the batteries are well-charged.

- Select the serial port the module is plugged into, which is generally COM 1.
- Select 38400 as the baud rate.
- Click the <Connect> button if the connection is not automatic.

Once a connection is made the “Connected” light will turn green and the module’s firmware version, serial number, and PCA version will be displayed in the upper left next to the PNI logo.

---

### 5.2.2 Changing Baud Rate

To change the baud rate:

- In the Module window, select the new baud rate for the module.
- Click the <Power Down> button. The button will change to read <Power Up>.
- In the Computer window, select same baud rate for the computer.
- Click the <Power Up> button. The button will revert back to <Power Down>.

---

*Note: While it is possible to select a baud rate of 230400, the serial port will not operate this fast.*

---

---

## 5.2.3 Changing Modules

Once a connection has been made, TCM Studio will recall the last settings. If a different module is used, click the <Connect> button once the new module is attached. This will reestablish a connection, assuming the module baud rate is unchanged.

---

## 5.3 Configuration Tab

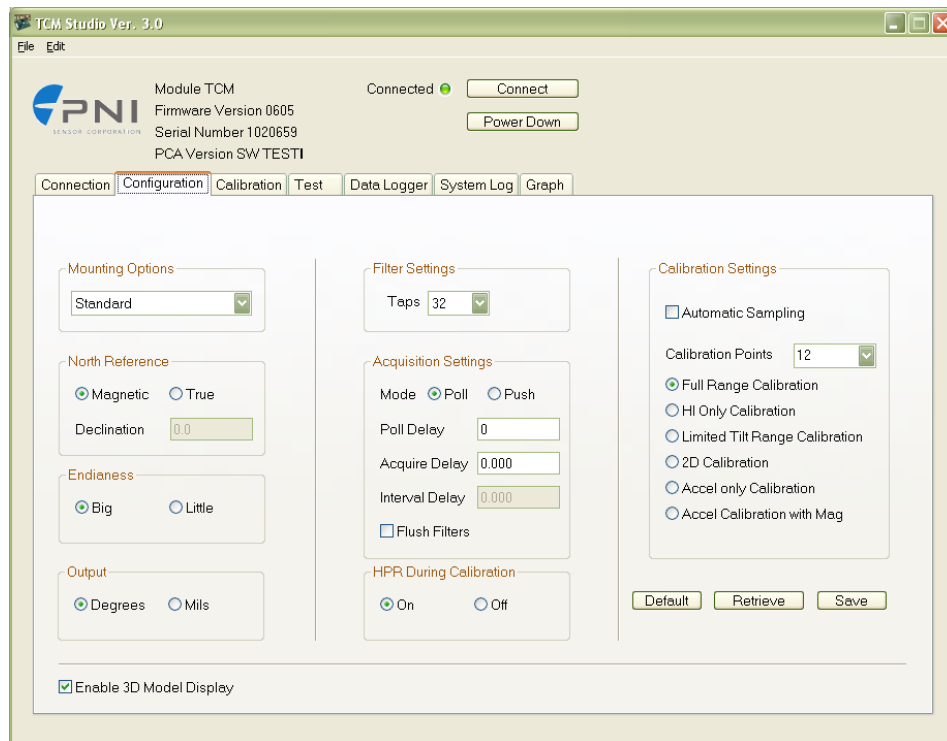

---

*Note: No settings will be changed in the module until the <SAVE> button has been selected.*

---

### 5.3.1 Mounting Options

TCM Studio supports 16 mounting orientations, as illustrated previously in Figure 4-1. The descriptions in TCM Studio are slightly different from those shown in Figure 4-1, and the relationship between the two sets of descriptions is given below.

**Table 5-1: Mounting Orientations**

TCM Studio Description	Figure 4-1 Description	TCM Studio Description	Figure 4-1 Description
Standard	STD 0°	Y Sensor Up	“Y” Up 0°
Standard 90 Degrees	STD 90°	Y Sensor Up Plus 90 Degrees	“Y” Up 90°
Standard 180 Degrees	STD 180°	Y Sensor Up Plus 180 Degrees	“Y” Up 180°
Standard 270 Degrees	STD 270°	Y Sensor Up Plus 270 Degrees	“Y” Up 270°
X Sensor Up	“X” Up 0°	Z Sensor Down	“Z” Down 0°
X Sensor Up Plus 90 Degrees	“X” Up 90°	Z Sensor Down Plus 90 Degrees	“Z” Down 90°
X Sensor Up Plus 180 Degrees	“X” Up 180°	Z Sensor Down Plus 180 Degrees	“Z” Down 180°
X Sensor Up Plus 270 Degrees	“X” Up 270°	Z Sensor Up Plus 270 Degrees	“Z” Down 270°

---

### 5.3.2 North Reference

#### Magnetic

When the <Magnetic> button is selected, heading will be relative to magnetic north.

#### True

When the <True> button is selected, heading will be relative to true north. In this case, the declination needs to be set in the “Declination” window. Refer to Section 6.3 for more information.

---

### 5.3.3 Endianness

Select either the <Big> or <Little> Endian button. The default setting is <Big>. See Sections 7.2 and 7.3 for additional information.

---

### 5.3.4 Output

The TCM module can output heading, pitch, and roll in either degrees or mils. Click either the <Degrees> or <Mils> button. The default is <Degrees>. (There are 6400 mils in a circle, such that 1 degree = 17.7778 mils and 1 mil = 0.05625 degree.)

---

### 5.3.5 Enable 3D Model

TCM Studio's Test tab includes a live-action 3-D rendering of a helicopter. Some computer systems may not have the graphics capability to render the 3D Model, for this reason it may be necessary to turn off this feature.

---

### 5.3.6 Filter Setting (Taps)

The TCM incorporates a finite impulse response (FIR) filter to effectively provide a more stable heading reading. The number of taps (or samples) represents the amount of filtering to be performed. The user should select either 0, 4, 8, 16, or 32 taps, with zero taps representing no filtering. Note that selecting a larger number of taps can significantly slow the time for the initial sample reading and, if "Flush Filters" is selected, the rate at which data is output. The default setting is 32.

---

### 5.3.7 Acquisition Settings

#### Mode

"Poll" mode should be selected when the host system will poll the TCM for data. TCM Studio allows the user to simulate this on their PC. In this case, TCM Studio requests data from the TCM module at a relatively fixed basis.

"Push" mode should be selected if the user will have the TCM output data at a relatively fixed rate to the host system. In this case the TCM module is pushing data out to TCM Studio at a relatively fixed rate.

#### Poll Delay

The Poll Delay is relevant when Poll Mode is selected, and is the time delay, in seconds, between the completion of TCM Studio receiving one set of sampled data and requesting the next sample set. If the time is set to "0", then TCM Studio requests new data as soon as the previous request has been fulfilled. Note that the inverse of the Poll Delay is somewhat greater than the sample rate, since the Poll Delay does not include actual acquisition time.

#### Interval Delay

The Interval Delay is relevant when Push Mode is selected, and is the time delay, in seconds, between completion of the TCM module sending one set of sampled data and the start of sending the next sample set. If the time is set to 0 then the TCM will begin sending new data as soon as the previous data set has been sent. Note that the inverse of the Interval Delay is somewhat greater than the sample rate, since the Interval Delay does not include actual acquisition time.

## Acquire Delay

The Acquire Delay sets the time between samples taken by the module, in seconds. This is an internal setting that is NOT tied to the time with which the module transmits data to TCM Studio or the host system. Generally speaking, the Acquire Delay is either set to 0, in which case the TCM is constantly sampling or set to equal either the Poll Delay or Interval Delay values. The advantage of running with an Acquire Delay of 0 is that the FIR filter can run with a relatively high Tap value to provide stable and timely data. The advantage of using a greater Acquire Delay is that power consumption can be reduced, assuming the Interval or Poll Delay are no less than the Acquire Delay.

## Flush Filters

The filtering is set to only update the filter with the last sample taken, for example once the initial 32 samples are taken (assuming Taps is set to the default value of 32) any new sample is added to the end with the first sample being dropped. In the case where the “Acquire Time” is set to a value it would be prudent to set the module to flush the filter prior to calculating the heading. This flushing will require the module to take 32 new samples to use for the calculation.

---

*Note: If the “Flush Filters” checkbox is checked, it will take longer for the module to output updated data.*

---

---

### 5.3.8 HPR During Calibration

When the <On> button is selected, heading, pitch, and roll will be output on the Calibration tab during a calibration.

---

### 5.3.9 Calibration Settings

#### Automatic Sampling

When selected the module will take a sample point once minimum change and stability requirements have been satisfied. If the user wants to have more control over when the point will be taken then Auto Sampling should be deselected. Once deselected, the <Take Sample> button on the Calibration tab will be active. Selecting the <Take Sample> button will indicate to the module to take a sample once the minimum requirements are met.

#### Calibration Points

The user can select the number of points to take during a calibration. The minimum number of points needed for an initial calibration is 10, although a hard-iron only (re)calibration can be performed with only 4 samples. The module will need to be

rotated through at least 180 degrees in the horizontal plane with a minimum of at least 1 positive and 1 negative Pitch and at least 1 positive and 1 negative Roll as part of the 12 points.

### **Calibration Method Buttons**

**Full Range Calibration** - recommended calibration method when  $>45^\circ$  of tilt is possible. The minimum recommended number of calibration points is 12.

**Hard Iron Only Calibration** - serves as a hard iron recalibration to a prior calibration. If the hard iron distortion around the module has changed, this calibration can bring the module back into specification. The minimum recommended number of calibration points is 6.

**Limited Tilt Range Calibration** - recommended calibration method when  $>5^\circ$  of tilt calibration is available, but tilt is restricted to  $<45^\circ$ . (i.e. full range calibration is not possible.) The minimum recommended number of calibration points is 12.

**2D Calibration** - recommended when the available tilt range is limited to  $\leq 5^\circ$ . The minimum recommended number of calibration points is 12.

**Accel Calibration Only** – The user should select this when accelerometer calibration will be performed. The minimum recommended number of calibration points is 18.

**Accel Calibration w/Mag** – The user should select this when magnetometer and accelerometer calibration will be performed simultaneously. The minimum recommended number of calibration points is 18.

---

#### **5.3.10 Default**

Clicking this button reverts TCM Studio program to the factory default settings.

---

#### **5.3.11 Retrieve**

Clicking on this button causes TCM Studio to read the settings from the module and display them on the screen.

## 5.4 Calibration Tab

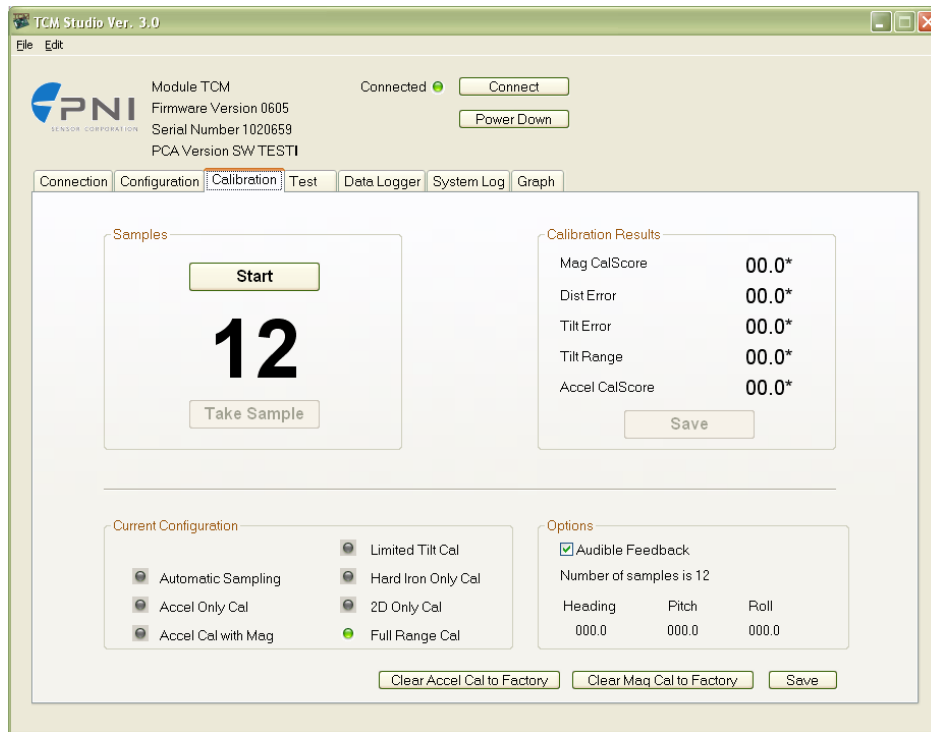

*Note: The default settings of the module are recommended for the highest accuracy and quality of calibration.*

### 5.4.1 Samples

Before proceeding, refer to Section 6.2 for the recommended calibration procedure corresponding to the calibration method selected on the Configuration tab.

Clicking the <Start> button begins the calibration process.

If “Automatic Sampling” is not checked on the Configuration tab, it is necessary to click the <Take Sample> button to take a calibration sample point. This should be repeated until the total number of samples (as set on the Configuration tab) is taken, changing the orientation of the module between samples as discussed in Section 6.2.

If “Automatic Sampling” is checked, the module will need to be held steady for a short time and then a sample automatically will be taken. Once the window indicates the next number, the module’s orientation should be changed and held steady for the next sample. Once the pre-set number of samples has been taken (as set on the Configuration tab) the calibration is complete.

---

## 5.4.2 Calibration Results

Once the calibration is complete the “Calibration Results” window will indicate the quality of the calibration. This may take a few seconds. The primary purpose of these scores is to demonstrate that the field calibration was successful, as demonstrated by a low CalScore. The other parameters provide information that may assist in improving the CalScore should it be unacceptably high.

### **Mag CalScore**

Represents the over-riding indicator of the quality of the magnetometer calibration. Acceptable scores will be <1 for Full Range Calibration, <2 for other methods. Note that it is possible to get acceptable scores for Dist Error and Tilt Error and still have a rather high Mag CalScore value. The most likely reason for this is the TCM is close to a source of local magnetic distortion that is not fixed with respect to the module.

### **Dist Error**

Indicates the quality of the sample point distribution, primarily looking for an even yaw distribution. Significant clumping or a lack of sample points in a particular section can result in a poor score. The score should be <1 and close to 0.

### **Tilt Error**

Indicates the contribution to the CalScore caused by tilt or lack thereof, and takes into account the calibration method. The score should be <1 and close to 0.

### **Tilt Range**

This reports the larger of either half the full pitch range or half the full roll range of sample points. For example, if the module is pitched +10° to -20°, and rolled +25° to -15°, the Tilt Range value would be 20° (as derived from  $[+25^\circ - \{-15^\circ\}]/2$ ). For Full Range Calibration and Hard Iron Only Calibration, this should be  $\geq 45^\circ$ . For 2D Calibration, this ideally should be  $\approx 2^\circ$ . For Limited Tilt Range Calibration the value should be as large as possible given the user’s constraints.

### **Accel CalScore**

Represents the over-riding indicator of the quality of the accelerometer calibration. Acceptable scores will be <1.

If either CalScore is too high, click the <Start> button to begin a new calibration. If the calibration is acceptable, then click the <Save> button in the “Calibration Results” window to save the calibration to the module’s flash. If this button is not selected then the module will need to be recalibrated after a power cycle.



---

*Note: If a calibration is aborted, all the score's will read "179.80", and the calibration coefficients will not be changed. (Clicking the <Save> button will not change the calibration coefficients.)*

---

### 5.4.3 Current Configuration

These indicators mimic the pertinent selections made on the Configuration tab.

---

### 5.4.4 Options

This window indicates how many samples are to be taken and provides real time heading, pitch, and roll information if "HPR During Calibration" is set to <On>, both as defined on the Configuration tab.

#### **Audible Feedback**

If selected TCM Studio will give an audible signal once a calibration point has been taken. Note that an audible signal also will occur when the <Start> button is clicked, but no data will be taken.

---

### 5.4.5 Clear

#### **Clear Mag Cal to Factory**

This button clears the user's calibration of the magnetometers. Once selected, the module reverts to its factory magnetometer calibration. To save this action in nonvolatile memory, click the <Save> button. It is not necessary to clear the current calibration in order to perform a new calibration.

#### **Clear Accel Cal to Factory**

This button clears the user's calibration of the accelerometers. Once selected, the module reverts back to its factory accelerometer calibration. To save this action in non-volatile memory, click the <Save> button. It is not necessary to clear the current calibration in order to perform a new calibration.

---

## 5.5 Test Tab

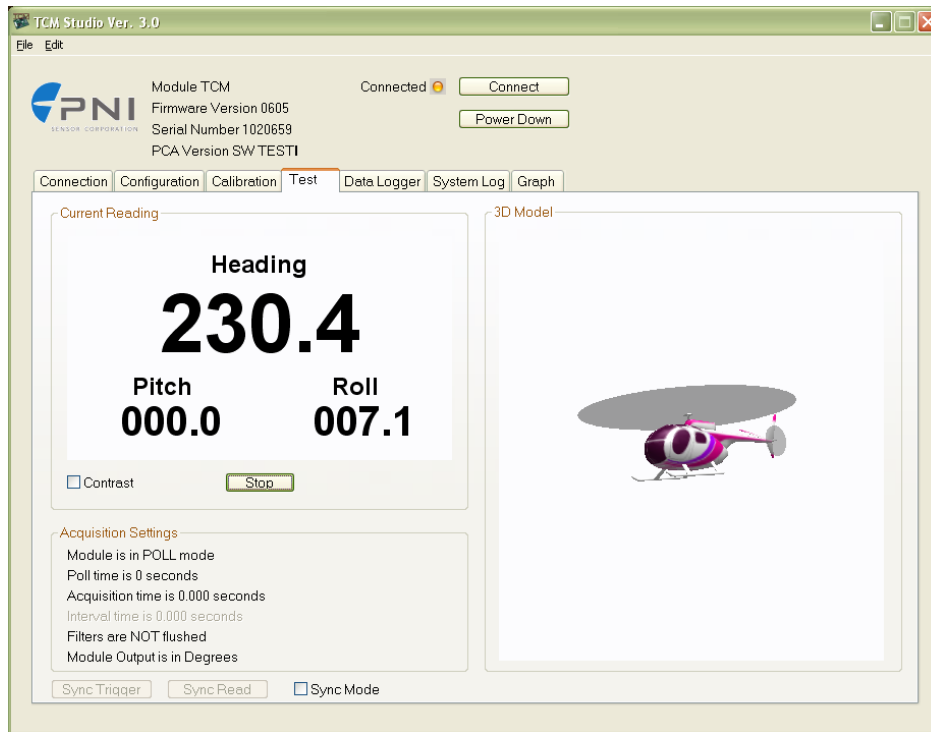

---

### 5.5.1 Current Reading

Once the <Go> button is selected the module will begin outputting heading, pitch and roll information. Selecting the <Stop> button or changing tabs will halt the output of the module.

#### Contrast

Selecting this box sets the “Current Readings” window to have yellow lettering on a black background, rather than black lettering on a white background.

---

### 5.5.2 3D Model

The helicopter will follow the movement of the TCM and give a visual representation of the module’s orientation, assuming the “Enable 3D Model Display” box is selected on the Configuration tab.

---

### 5.5.3 Acquisition Settings

These indicators mimic the pertinent selections made on the Configuration tab.

---

## 5.5.4 Sync Mode

Sync Mode enables the module to stay in sleep mode until the user's system sends a trigger to report data. When so triggered, the TCM will wake up, report data once, then return to sleep mode. One application of this is to lower power consumption. Another use of the Sync Mode is to trigger a reading during an interval when local magnetic sources are well understood. For instance, if a system has considerable magnetic noise due to nearby motors, the Sync Mode can be used to take measurements when the motors are turned off.

### Enter Sync Mode

On the Test tab, above the tabs and 3D model, click the “Sync Mode” check box to enter Sync Mode.

### Sync Mode Output

To retrieve the first reading, click the <Sync Read> button. Heading, pitch and roll information will be displayed on Current Reading window. If the “Enable 3D Model Display” box is selected on the Configuration tab, then the helicopter will follow the movement as well. The module will enter sleep mode after outputting the heading, pitch, and roll information. To obtain subsequent readings, the user should first click on the <Sync Trigger> button to wake up the module and then click on the <Sync Read> button to get the readings, after which the module will return to sleep.

### Exit Sync Mode

Click on the <Sync Trigger> button and then uncheck the “Sync Mode” check box to exit Sync Mode.

Note that <Sync Trigger> sends a 0xFF signal as an external interrupt to wake up the module. This is not done for the first reading as the module is already awake.

## 5.6 Data Logger Tab

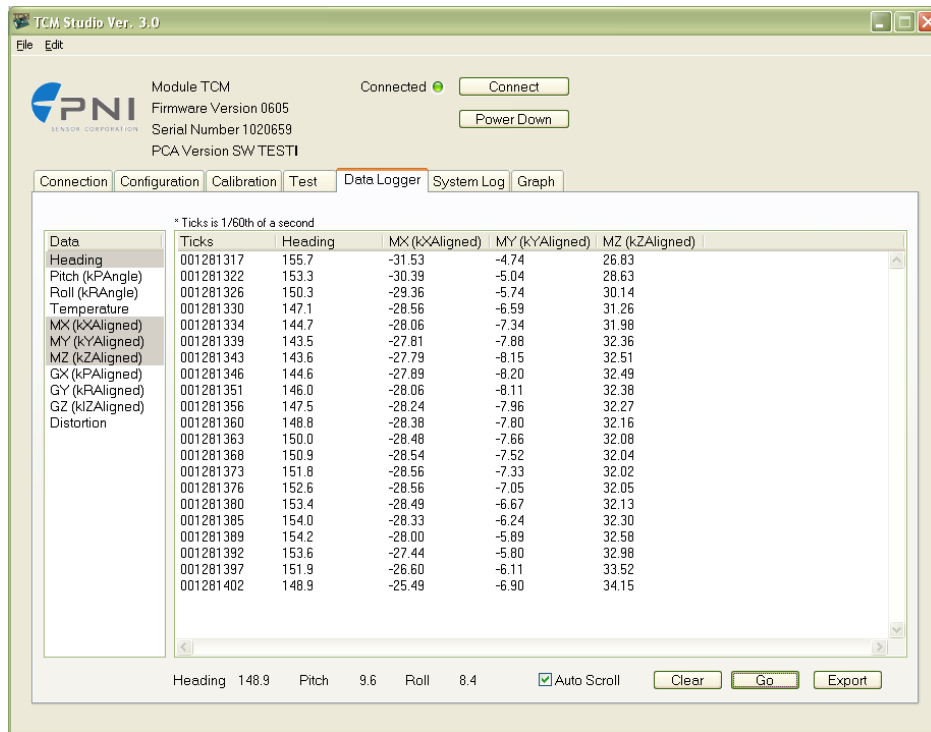

TCM Studio can capture measurement data and then export it to a text file. To acquire data and export it, follow the procedure below:

- Select the parameters you wish to log in the “Data” window. Use Shift-Ctrl-Click and Ctrl-Click to select multiple items. (In the screen shot above, “Heading”, “MX (kXAligned)”, “MY (kYAligned)”, and “MZ (kZAligned)” were selected.)
- Click the <Go> button to start logging. The <Go> button changes to a <Stop> button after data logging begins.
- Click the <Stop> button to stop logging data.
- Click the <Export> button to save the data to a file.
- Click the <Clear> button to clear the data from the window.

---

*Note: The data logger use ticks for time reference. A tick is 1/60 second.*

---

## 5.7 System Log Tab

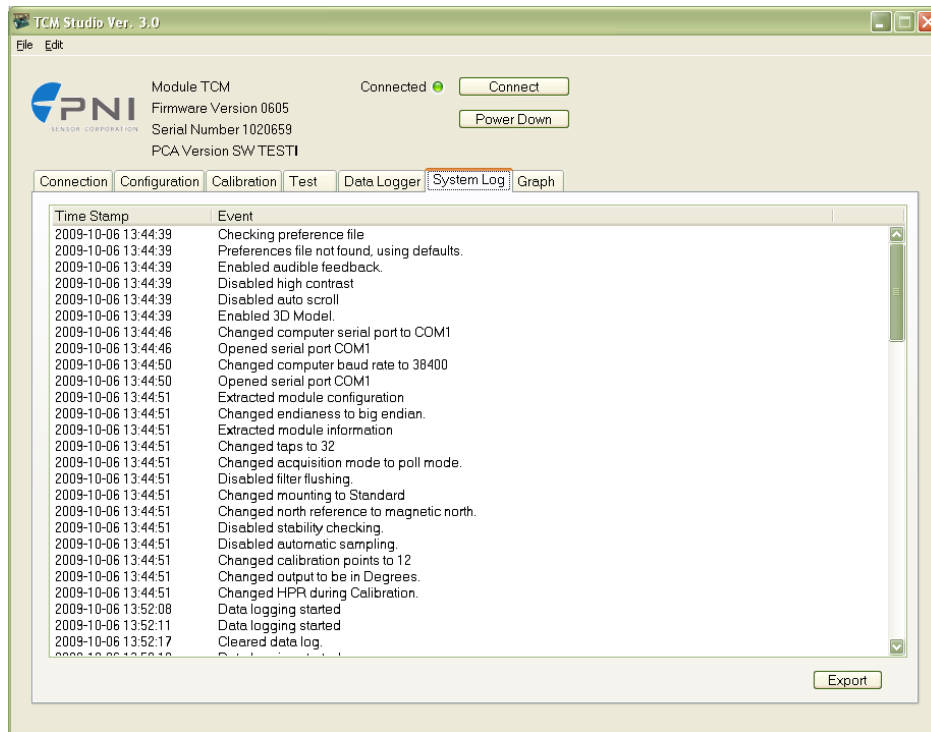

The System Log tab shows all communication between TCM Studio and the TCM module since TCM Studio was opened. Closing TCM Studio will erase the system log.

Select the <Export> button, at the bottom right of the screen, to save the system log to a text file.

## 5.8 Graph Tab

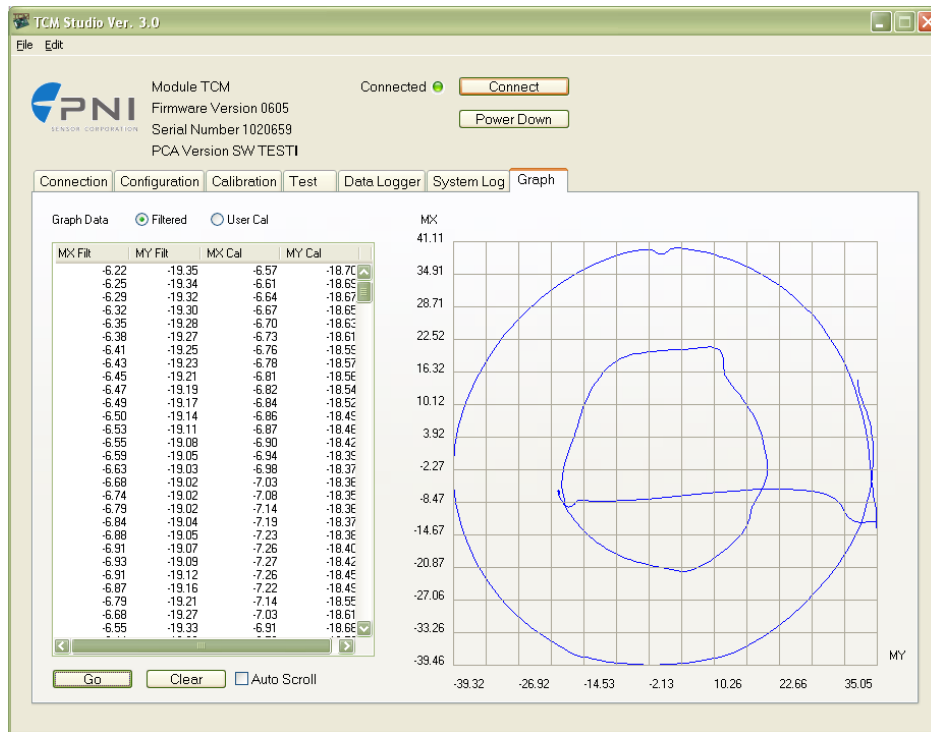

The graph provides a 2-axis (X,Y) plot of the measured field strength. The graph can be used to visually see hard and soft iron effects within the environment measured by the TCM module as well as corrected output after a user calibration has been performed. (The screen shot shows the MX and MY readings as the module was held horizontally and rotated through 360° in the horizontal plane, then held in a vertical orientation and rotated 360° in the vertical plane.)

---

## 6 Field Calibration

The magnetic sensors and accelerometers in the TCM are calibrated at PNI's factory. However, this is done in a magnetically controlled environment. Consequently, sources of magnetic distortion positioned near the TCM in the user's system will distort Earth's magnetic field and should be compensated for in the host system. Examples of such sources include ferrous metals and alloys (ex. iron, nickel, non-stainless steel, etc.), batteries, audio speakers, current-carrying wires, and electric motors. Compensation is accomplished by calibrating the module while mounted in the user's system. It is expected that the sources of magnetic distortion will remain fixed relative to the module's position within the user's system. By performing a field calibration, the TCM identifies the local sources of magnetic distortion and negates their effects from the overall reading to provide an accurate compass heading.

Additionally, the TCM's MEMS accelerometers gradually may change over time, and it may be desirable to recalibrate the accelerometers from time-to-time. The accelerometer calibration procedure corrects for changes in accelerometer gain and offset. Unlike the magnetometers, the accelerometers may be calibrated outside the host system. Accelerometer calibration is more sensitive to noise or hand jitter than magnetometer calibration, especially for subsequent use at high tilt angles. Because of this, a stabilized fixture is recommended for accelerometer calibration, although resting the unit against a stable surface often is sufficient. Alternatively, the TCM can be returned to PNI for accelerometer recalibration.

### **Key Points:**

- Accelerometer calibration requires rotating the TCM through a full sphere of coverage. But the TCM does need to be incorporated into the user's system during calibration.
- Magnetometer calibration requires incorporating the module into the user's system such that the magnetic components of the user's system can be compensated for.
- Magnetometer and accelerometer calibrations can be performed simultaneously. But it may be easier to perform them separately since the requirements of each calibration are significantly different. (Magnetometer calibration requires the module be incorporated in the user's system, while accelerometer calibration requires full sphere coverage.)
- Full Range (magnetometer) Calibration provides the highest heading accuracy, but often performing a Full Range Calibration is not practical. 2D and Limited Tilt Calibration allow for good calibration when the range of allowable motion is limited. Hard Iron Only Calibration relatively easily updates the hard-iron compensation coefficients.
- The number of calibration sample points and the calibration pattern is dependent on the calibration method, and these are discussed in Section 6.2.
- Pay attention to the calibration scores. See Section 5.4.2 or Section 7.4.17.

---

## 6.1 Magnetic Field Calibration Theory

The main objective of a magnetic field calibration is to compensate for distortions to the magnetic field caused by the host system. To that end, the TCM needs to be mounted within the host system and the entire host system needs to be moved as a single unit during the calibration. The TCM allows the user to perform a calibration only in a 2D plane (2D Calibration Method) or with limited tilt, but provides the greatest accuracy if the user can rotate through a full sphere.

---

### 6.1.1 Hard and Soft Iron Effects

Hard iron distortions are caused by permanent magnets and magnetized steel or iron objects within close proximity to the sensors. This type of distortion remains constant and in a fixed location relative to the sensors for all heading orientations. Hard-iron distortions add a constant magnitude field component along each axis of sensor output.

Soft-iron distortions are the result of interactions between the Earth's magnetic field and any magnetically "soft" material within close proximity to the sensors. In technical terms, soft materials have a high permeability. The permeability of a given material is a measure of how well it serves as a path for magnetic lines of force, relative to air, which has an assigned permeability of one. Unlike hard-iron distortion, soft-iron distortion changes as the host system's orientation changes, making it more difficult to compensate.

The TCM 3-axis digital compass features both soft-iron and hard-iron correction.

---

### 6.1.2 Pitch and Roll

The TCM uses MEMS accelerometers to measure the tilt angle of the compass. This data is output as pitch and roll data, and is also used in conjunction with the magnetometers to provide a tilt-compensated heading reading.

The TCM utilizes Euler angles as the method for determining accurate orientation. This method is the same used in aircraft orientation where the outputs are Heading (Yaw), Pitch and Roll. When using Euler angles, roll is defined as the angle rotated around an axis through the center of the fuselage while pitch is rotation around an axis through the center of the wings. These two rotations are independent of each other since the rotation axes rotate with the plane body.

For the TCM a positive pitch is when the front edge of the board is rotated upward and a positive roll is when the right edge of the board is rotated downward.



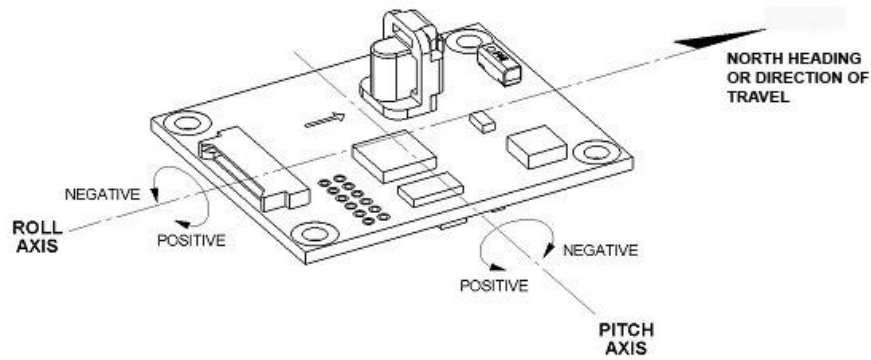

Figure 6-1: Positive & Negative Roll and Pitch Definition

## 6.2 Field Calibration Procedures

Below are instructions for performing both magnetic and accelerometer field calibrations of the TCM module. Calibration of the TCM XB may be performed using TCM Studio or using the PNI binary protocol, while the calibration of the TCM MB must be performed using the PNI binary protocol. The calibration sequences described in the following sections demonstrate a good distribution of the recommended minimum sample points. Note that during calibration it is recommended that the location of the module remains fairly constant while the orientation is changed.

Table 6-1: Calibration Mode Summary

Calibration Mode	Sensors Calibrated	Accuracy	Tilt Range during Calibration	Number of Samples
Full Range	Magnetic Sensors	0.3° rms	>±45°	10 to 32
2D Calibration	Magnetic Sensors	<2°	<±5°	10 to 32
Limited Tilt Range	Magnetic Sensors	<2° over 2x tilt range	±5° to ±45°	10 to 32
Hard Iron Only	Magnetic Sensors	Restores prior accuracy	>±3°	4 to 32
Accelerometer Only	Accelerometers	Restores prior accuracy	±180°	12 to 32
Accel and Mag	Magnetic Sensors & Accelerometers	0.3° rms	±180°	12 to 32

Before proceeding with a calibration, ensure the TCM module is properly installed in the host system. The module should be properly installed, as discussed in Section 4, and the software should be properly configured with respect to the mounting orientation, Endianness, magnetic vs. true north, etc.

Sections 5.3 and 5.4 outline how to perform a calibration using TCM Studio. To perform a calibration using the PNI binary protocol, follow the steps listed below. Refer to Section 7 for information on how to implement the commands listed.

- Using the `kSetParam` command, set the number of tap filters to 32.
- Using the `kSetConfig` command, set `kUserCalAutoSampling`. “False” is generally recommended, but “True” may be more convenient.
- Using the `kSetConfig` command, set `kCoeffCopySet` (magnetometer calibration) and/or `kAccelCoeffCopySet` (accelerometer calibration). These fields allow the user to save multiple sets of calibration coefficients. “0” is the default.
- Using the `kSetConfig` command again, set `kUserCalNumPoints` to the appropriate number of calibration points. The number of calibration points should be at least 12 for Full Range Calibration, Limited Tilt Range Calibration and 2D Calibration; at least 6 for Hard Iron Only Calibration; and at least 18 for Accel Only Calibration and Accel and Mag Calibration.
- Initiate a calibration using the `kStartCal` command. Note that this command requires indentifying the type of calibration procedure (i.e. Full Range, 2D, etc.).
- Follow the appropriate calibration procedure discussed in Sections 6.2.1 to 6.2.6. If `kUserCalAutoSampling` was set to “False”, then send a `kTakeUserCalSample` command when ready to take a calibration point. If `kUserCalAutoSampling` was set to “True”, then look for `kUserCalSampCount` to confirm when a calibration point has been taken. During the calibration process, heading, pitch, and roll information will be output from the module, and this can be monitored using `kDataResp`.
- When the final calibration point is taken, the module will present the calibration score using `kUserCalScore`.
- If the calibration is acceptable (see Section 7.4.17), save the calibration coefficients using `kSave`.

---

## 6.2.1 Full Range Calibration

This calibration method is appropriate when the module can be tilted  $\pm 45^\circ$  or more. The Full Range Calibration option calibrates out hard and soft iron effects in three dimensions, and allows for the highest accuracy readings. Two calibration patterns are discussed below.

The 12 Point North-Unaware Calibration Pattern is a series of 3 circles of evenly spaced points, with as much tilt variation as expected during use. This calibration pattern does not require knowing which direction the module is facing nor does it require turning the module upside down. The 18 Point North-Aware Calibration Pattern can provide

superior results, especially at high dip angles (associated with high latitudes), but is more complicated and requires: 1) knowing the direction of north prior to calibration, 2) turning the module upside down, and 3) 18 calibration points.

### 12 Point North-Unaware Calibration Pattern

Move the module to the following positions noting that these are not absolute heading directions but rather relative heading changes referenced to your first heading sample. You do not need to know actual true or magnetic north. While Figure 6-2 shows the location of the module changing, this is for illustration purposes and it is best for the location of the module to remain fairly constant while only the orientation is changed.

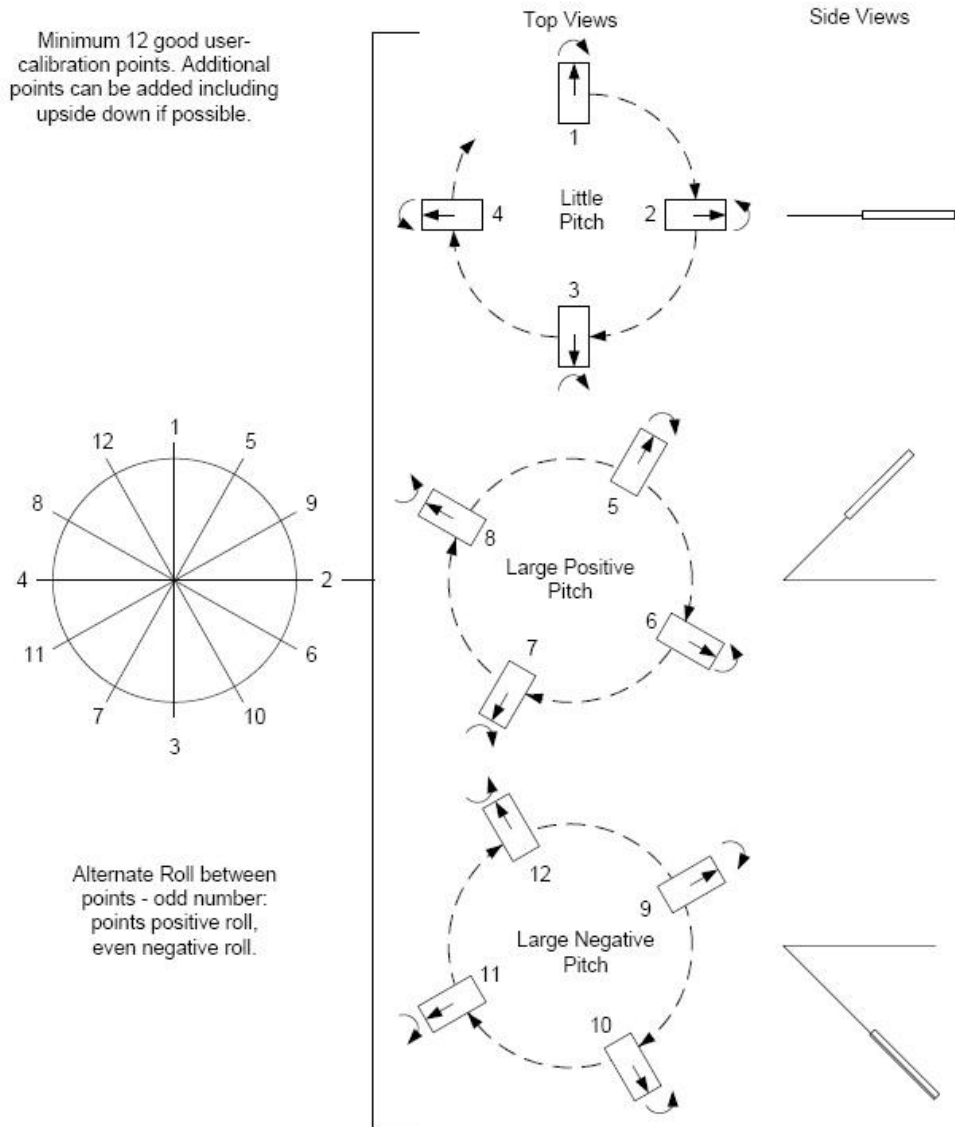

Figure 6-2: Full Range Calibration with 12 Point North-Unaware Cal. Pattern

**Table 6-2: 12 Point North-Unaware Calibration Pattern**

Sample #	Yaw	Pitch	Roll
First Circle			
1	0°	±5°	30° to 40°
2	90°	±5°	-30° to -40°
3	180°	±5°	30° to 40°
4	270°	±5°	-30° to -40°
Second Circle			
5	30°	> +45°	30° to 40°
6	120°	> +45°	-30° to -40°
7	210°	> +45°	30° to 40°
8	300°	> +45°	-30° to -40°
Third Circle			
9	60°	< -45°	30° to 40°
10	150°	< -45°	-30° to -40°
11	240°	< -45°	30° to 40°
12	330°	< -45°	-30° to -40°

### 18 Point North-Aware Calibration Pattern

The pattern consists of three rotations of the module, with 6 calibration points taken for each rotation. The first rotation starts with the module horizontal and pointing north, then rotating about the module's y axis. The second rotation starts with the module horizontal and pointing east, then rotating about the module's x axis. The third rotation starts with the module vertical and pointing north, then rotating about the module's z axis.

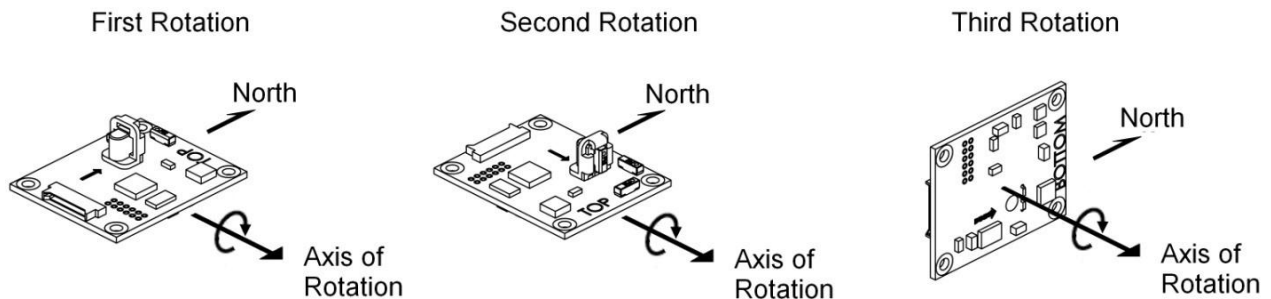

*Figure 6-3: Full Range Calibration with 18 Point North-Aware Cal. Pattern*

**Table 6-3: 18 Point North-Aware Calibration Pattern**

Sample #	Heading	Pitch	Roll
First Rotation			
1	0°	0°	0°
2	0°	-60°	0°
3	180°	-60°	180°
4	180°	0°	180°
5	180°	60°	180°
6	0°	60°	0°
Second Rotation			
7	90°	0°	0°
8	90°	0°	60°
9	90°	0°	120°
10	90°	0°	180°
11	90°	0°	-120°
12	90°	0°	-60°
Third Rotation			
13	0°	0°	-90°
14	0°	-60°	-90°
15	180°	-60°	90°
16	180°	0°	90°
17	180°	60°	90°
18	0°	60°	-90°

## 6.2.2 2D Calibration

This calibration procedure is used for very low tilt operation ( $< 5^\circ$ ) where calibrating the module with greater tilt is not practical.

The 2D Calibration procedure calibrates for hard and soft iron effects in only two dimensions, and in general is effective for operation and calibration in the tilt range of  $-5^\circ$  to  $+5^\circ$ . The recommended calibration pattern is a circle of evenly spaced points. Results will be optimized if the tilt in the calibration procedure can match the actual tilt experienced when in service. For example, if the TCM will be restrained to a level plane in service, best results are obtained if calibration is exclusively in a plane, where “maximum...tilt” below would be  $0^\circ$ . PNI recommends 12 to 32 calibration points for 2D Calibration, although 10 points are acceptable but less likely to yield good results.

**Table 6-4: 12 Point 2D Calibration Pattern**

Sample #	Yaw	Pitch	Roll
1	0°	0°	0°
2	30°	max. negative	max. negative
3	60°	0°	0°
4	90°	max. positive	max. positive
5	120°	0°	0°
6	150°	max. negative	max. negative
7	180°	0°	0°
8	210°	max. positive	max. positive
9	240°	0°	0°
10	270°	max. negative	max. negative
11	300°	0°	0°
12	330°	max. positive	max. positive

### 6.2.3 Limited Tilt Range Calibration

This procedure is recommended when 45° of tilt isn't feasible, but >5° of tilt is possible. It provides both hard iron and soft iron distortion correction. The recommended calibration pattern is a series of 3 circles of evenly spaced points, with as much tilt variation as expected during use. PNI recommends 12 to 32 calibration points for a Limited Tilt Range Calibration, although 10 calibration points is acceptable but less likely to yield good results.

**Table 6-5: 12 Point Limited Tilt Calibration Pattern**

Sample #	Yaw	Pitch	Roll
First Circle			
1	0°	0°	0°
2	90°	0°	0°
3	180°	0°	0°
6	270°	0°	0°
Second Circle			
7	45°	> +5°	> +5°
8	135°	> +5°	> +5°
11	225°	> +5°	> +5°
12	315°	> +5°	> +5°
Third Circle			
13	45°	< -5°	< -5°
14	135°	< -5°	< -5°
17	225°	< -5°	< -5°
18	315°	< -5°	< -5°

Note that a similar and acceptable alternative pattern would be to follow the recommended 12 point North-Unaware Full Range Calibration pattern, but substituting the  $>\pm 45^\circ$  of pitch with whatever pitch can be achieved and the  $\pm 10^\circ$  to  $\pm 20^\circ$  or roll with whatever roll can be achieved up to these limits. (See Section 6.2.1)

## 6.2.4 Hard Iron Only Calibration

Over time the magnetic distortions around the TCM may change for a variety of reasons. The Hard Iron Only Calibration allows for quick recalibration of the module for hard iron effects, and generally is effective for operation and calibration in the tilt range of  $3^\circ$  or more ( $\geq 45^\circ$  is preferred). The recommended calibration pattern is a circle of alternately tilted, evenly spaced points, with as much tilt as expected during use. PNI recommends  $\geq 6$  calibration points for a Hard Iron Only Calibration, although 4 points is acceptable.

**Table 6-6: 6 Point Hard Iron Only Calibration Pattern**

Sample #	Yaw	Pitch	Roll
1	$0^\circ$	$-45^\circ$	$-45^\circ$
2	$60^\circ$	$+45^\circ$	$+45^\circ$
3	$120^\circ$	$-45^\circ$	$-45^\circ$
4	$180^\circ$	$+45^\circ$	$+45^\circ$
5	$240^\circ$	$-45^\circ$	$-45^\circ$
6	$300^\circ$	$+45^\circ$	$+45^\circ$

## 6.2.5 Accelerometer Only Calibration

The requirements for a good accelerometer calibration differ from the requirements for a good magnetometer calibration. For instance, a level yaw sweep, no matter how many points are acquired, is effectively only 1 accelerometer calibration point. PNI recommends 18 to 32 calibration points for accelerometer calibration, although 12 calibration points is acceptable.

Figure 6-4 shows the two basic starting positions for the Accelerometer Only Calibration. Calibration can occur within the user's system or with the module alone. It is not necessary to place the TCM on a hard surface as shown, but it must be held very still during calibration, and holding it against a hard surface is one method to help ensure this. Starting with the module as shown on the left in Figure 6-4, rotate the module such that it sits on each of its 6 faces. Take a calibration point on each face. Starting with the module as shown on the right, take a calibration point with it being vertical ( $0^\circ$ ). Now tilt the module back  $45^\circ$  and take another calibration point ( $+45^\circ$ ), then tilt the module forward  $45^\circ$  and take another calibration point ( $-45^\circ$ ). Repeat this 3 point calibration process for the module with it resting on each of its 4 corners.

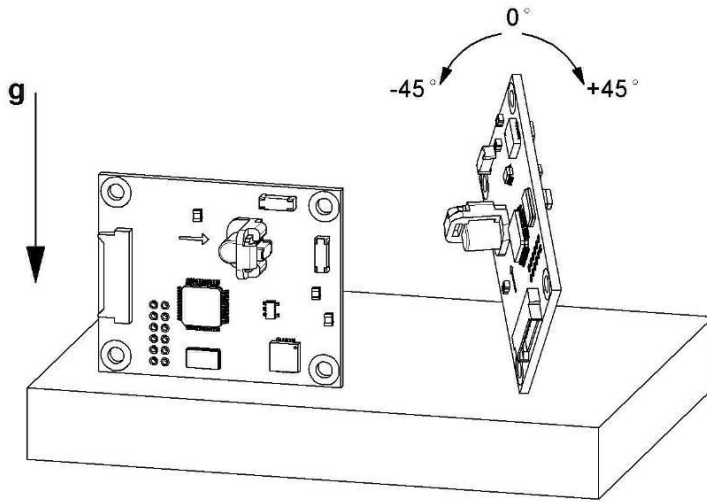

Figure 6-4: Accelerometer Calibration Starting Orientations

Table 6-7: 18 Point Accelerometer Calibration Pattern

Sample #	Yaw	Pitch	Roll
<b>Sides</b>			
1	0°	0°	90°
2	0°	90°	90°
3	180°	0°	-90°
4	0°	-90°	90°
5	0°	0°	0°
6	0°	0°	180°
<b>First Corner</b>			
7	0°	±5°	10° to 20°
8	90°	±5°	-10° to -20°
9	180°	±5°	10° to 20°
<b>Second Corner</b>			
10	270°	±5°	-10° to -20°
11	30°	> +45°	10° to 20°
12	120°	> +45°	-10° to -20°
<b>Third Corner</b>			
13	210°	> +45°	10° to 20°
14	300°	> +45°	-10° to -20°
15	60°	< -45°	10° to 20°
<b>Fourth Corner</b>			
16	150°	< -45°	-10° to -20°
17	240°	< -45°	10° to 20°
18	330°	< -45°	-10° to -20°



---

## 6.2.6 Mag and Accel Calibration

The TCM allows for a simultaneous magnetometer and accelerometer calibration. This requires a good calibration pattern, stable measurements (not handheld), and installation in the user's system such that the appropriate local magnetic environment is present. PNI recommends 18 to 32 calibration points for a Mag and Accel Calibration, although 12 points is acceptable but less likely to yield good results. The Accelerometer Only Calibration pattern discussed in Section 6.2.5 will work for a Mag and Accel Calibration. Optimal performance is obtained when all rotations of the cube are performed towards magnetic north to achieve the widest possible magnetic field distribution.

Note that combining calibrations only makes sense if all the host system's magnetic distortions (steel structures or batteries, for instance) are present and fixed relative to the module when calibrating. If the Accelerometer Only Calibration is performed, the user's system distortions are not relevant, which allows the TCM to be removed from the host system in order to perform the Accelerometer Only Calibration.

---

## 6.3 Declination Value

Declination, also called magnetic variation, is the difference between true and magnetic north. It is measured in degrees east or west of true north. Correcting for declination is accomplished by storing the correct declination angle, and then changing the heading reference from magnetic north to true north. Declination angles vary throughout the world, and change very slowly over time. For the greatest possible accuracy, go to the National Geophysical Data Center web page below to get the declination angle based on your latitude and longitude: <http://www.ngdc.noaa.gov/geomagmodels/Declination.jsp>

---

## 6.4 Other Considerations

The TCM measures the total magnetic field within its vicinity, and this is a combination of Earth's magnetic field and local magnetic sources. The TCM can compensate for local static magnetic sources. However, a magnetic source which is not static can create errors (such as a motor which turns on/off), and it is not possible to compensate for such a dynamic nature. In such cases, moving the TCM away from dynamic magnetic fields is recommended, or taking measurements only when the state of the magnetic field is known (ex. only take measurements when a nearby motor is turned off).

# 7 Operation with PNI Binary Protocol

The TCM utilizes a binary protocol that is transmitted over an RS232 UART (TCM XB) or a TTL UART (TCM MB). The parameters should be set as follows:

**Table 7-1: UART Configuration**

Parameter	Value
Number of Data Bits	8
Start Bits	1
Stop Bits	1
Parity	none

## 7.1 Datagram Structure

The data structure is shown below:

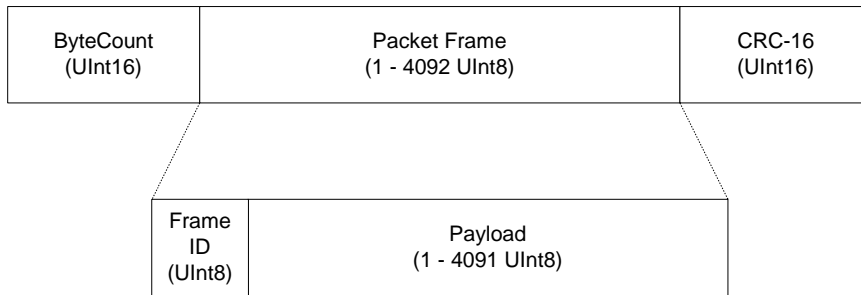

*Figure 7-1: Datagram Structure*

The ByteCount is the total number of bytes in the packet including the CRC-16 (checksum). CRC-16 is calculated starting from the ByteCount to the last byte of the Packet Frame. The ByteCount and CRC-16 are always transmitted in big Endian. Two examples follow.

**Example:** The complete packet for the kGetModInfo command, which has no payload is:

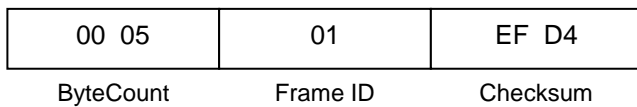

**Example:** Below is a complete sample packet to start a 2D Calibration (kStartCal):

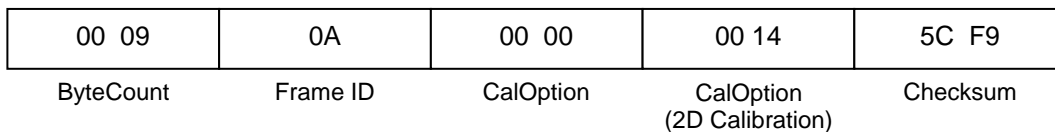

## 7.2 Parameter Formats

*Note: Floating-point based parameters conform to ANSI/IEEE Std 754-1985. Please refer to the Standard for more information. PNI also recommends the user refer to the compiler's instructions to understand how the compiler implements floating-point format.*

### 64 Bit Floating Point (Float64)

Below is the 64 bit float format in big Endian. In little Endian, the bytes are in reverse order in 4 byte groups. (eg. big Endian: ABCD EFGH; little Endian: DCBA HGFE).



The value (v) is determined as (if and only if  $0 < \text{Exponent} < 2047$ ):  $v = (-1)^S * 2^{(\text{Exponent}-1023)} * 1.\text{Mantissa}$

### 32 Bit Floating Point (Float32)

Shown below is the 32 bit float format in big Endian. In little Endian format, the 4 bytes are in reverse order (LSB first).

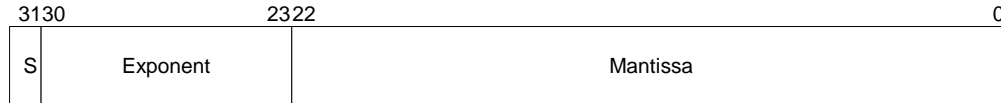

The value (v) is determined as (if and only if  $0 < \text{Exponent} < 255$ ):  $v = (-1)^S * 2^{(\text{Exponent}-127)} * 1.\text{Mantissa}$

### Signed 32 Bit Integer (SInt32)

SInt32-based parameters are signed 32 bit numbers (2's compliment). Bit 31 represents the sign of the value (0=positive, 1=negative)

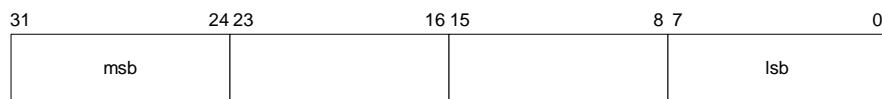

Big Endian

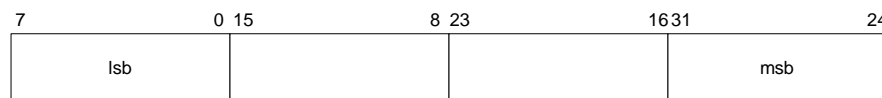

Little Endian

### Signed 16 Bit Integer (SInt16)

SInt16-based parameters are signed 16 bit numbers (2's compliment). Bit 15 represents the sign of the value (0=positive, 1=negative)

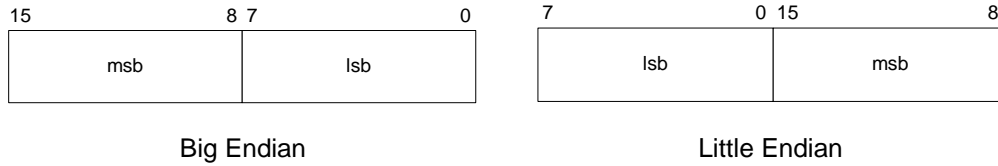

### Signed 8 Bit Integer (SInt8)

UInt8-based parameters are unsigned 8-bit numbers. Bit 7 represents the sign of the value (0=positive, 1=negative)

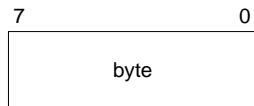

### Unsigned 32 Bit Integer (UInt32)

UInt32-based parameters are unsigned 32 bit numbers.



### Unsigned 16 Bit Integer (UInt16)

UInt16-based parameters are unsigned 16 bit numbers.

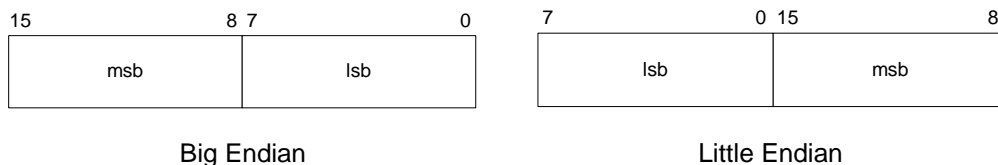

### Unsigned 8 Bit Integer (UInt8)

UInt8-based parameters are unsigned 8-bit numbers.



## Boolean

Boolean is a 1-byte parameter that **MUST** have the value 0 (FALSE) or 1 (TRUE).



## 7.3 Commands & Communication Frames

**Table 7-2: Command Set**

Frame ID <sub>d</sub>	Command	Description
1	kGetModInfo	Queries the modules type and firmware revision number.
2	kModInfoResp	Response to kGetModInfo
3	kSetDataComponents	Sets the data components to be output.
4	kGetData	Queries the module for data
5	kDataResp	Response to kGetData
6	kSetConfig	Sets internal configurations in the module
7	kGetConfig	Queries the module for the current internal configuration value
8	kConfigResp	Response to kGetConfig
9	kSave	Commands the module to save internal and user calibration
10	kStartCal	Commands the module to start user calibration
11	kStopCal	Commands the module to stop user calibration
12	kSetParam	Sets the FIR filter settings for the magnetometer & accelerometer sensors.
13	kGetParam	Queries for the FIR filter settings for the magnetometer & accelerometer sensors.
14	kParamResp	Contains the FIR filter settings for the magnetometer & accelerometer sensors.
15	kPowerDown	Used to completely power-down the module
16	kSaveDone	Response to kSave
17	kUserCalSampCount	Sent from the module after taking a calibration sample point
18	kUserCalScore	Contains the calibration score
19	kSetConfigDone	Response to kSetConfig
20	kSetParamDone	Response to kSetParam
21	kStartIntervalMode	Commands the module to output data at a fixed interval
22	kStopIntervalMode	Commands the module to stop data output at a fixed interval
23	kPowerUp	Sent after wake up from power down mode
24	kSetAcqParams	Sets the sensor acquisition parameters

25	kGetAcqParams	Queries for the sensor acquisition parameters
26	kAcqParamsDone	Response to kSetAcqParams
27	kAcqParamsResp	Response to kGetAcqParams
28	kPowerDownDone	Response to kPowerDown
29	kFactoryUserCal	Clears user magnetometer calibration coefficients
30	kFactorUserCalDone	Response to kFactoryUserCal
31	kTakeUserCalSample	Commands the module to take a sample during user calibration
36	kFactoryInclCal	Clears user accelerometer calibration coefficients
37	kFactoryInclCalDone	Respond to kFactoryInclCal
46	kSetMode	Sets the mode of operation of the system
47	kSetModeResp	Response to kSetMode
49	kSyncRead	Queries the module for data in Sync Mode

## 7.4 kGetModInfo (frame ID 1d)

This frame queries the module's type and firmware revision number. The frame has no payload.

### 7.4.1 kModInfoResp (frame ID 2d)

This frame is the response to kGetModInfo frame. The payload contains the module type identifier followed by the firmware revision number.

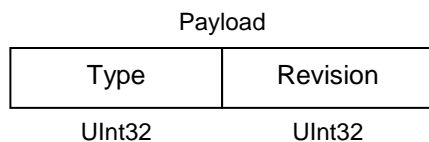

Note that the Type and Revision can be decoded from the binary format to character format using the ASCII standard. For example, the hex string “00 0D 02 54 43 4D 35 31 32 30 38 C7 87” can be decoded to read “TCM5 1208”. Also, the TCM XB is referenced as Type “TCM6” since the number of Type characters is limited to 4.

### 7.4.2 kSetDataComponents (frame ID 3d)

This frame sets the data components in the module's data output. This is not a query for the module's data (see kGetModInfo). The first byte of the payload indicates the number of data components followed by the data component IDs.

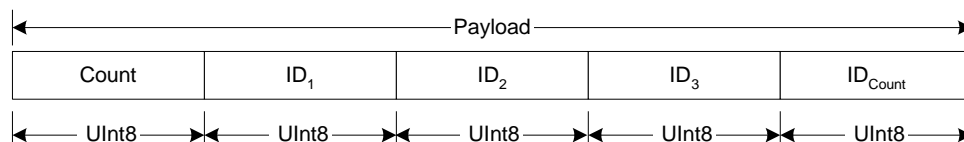

**Example:** To query the heading and pitch, the payload should contain

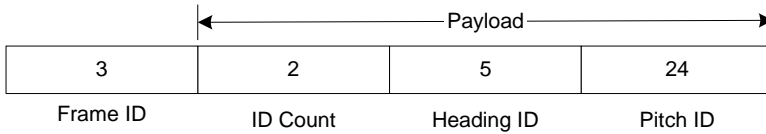

When querying for data (kGetData frame), the sequence of the data component output follows the sequence of the data component IDs as set in this frame.

**Table 7-3: Component Identifiers**

Component	Component ID <sub>d</sub>	Format	Units	Range
kHeading	5	Float32	degrees (default) or mils	0.0° to 359.9°
kTemperature	7	Float32	° Celsius	-40° to 85°
kDistortion	8	Boolean	True or False	False (Default) = no distortion
kCalStatus	9	Boolean	True or False	False (Default) = not calibrated
kPAligned	21	Float32	G	-1.0 to 1.0
KRALigned	22	Float32	G	-1.0 to 1.0
kIZAligned	23	Float32	G	-1.0 to 1.0
kPAngle	24	Float32	degrees	-90.0° to 90.0°
kRAngle	25	Float32	degrees	-180.0° to 180.0°
KXAligned	27	Float32	μT	
KYAligned	28	Float32	μT	
KZAligned	29	Float32	μT	

Component types are listed below. All are read-only values.

**kHeading (Component ID 5<sub>d</sub>)**

Provides compass heading (i.e. yaw or azimuth) output. The units default to degrees, but can be set to mils using kMilOutput

**kTemperature (Component ID 7<sub>d</sub>)**

This value is provided by the module's internal temperature sensor. Its value is in ° Celsius and has an accuracy of ±3° C.

**kDistortion (Component ID 8<sub>d</sub>)**

This flag indicates at least one magnetometer axis reading is beyond ±125 μT.

### **kCalStatus (Component ID 9<sub>d</sub>)**

This flag indicates the user calibration status. False (default) = not calibrated.

### **kPAligned, kRAligned & kZAligned (Component IDs 21<sub>d</sub>, 22<sub>d</sub>, 23<sub>d</sub>)**

These values represent Earth's calibrated acceleration vector (G) components. The default values are the factory calibrated values. Up to three (3) sets of values can be stored using kAccelCoeffCopySet (see Section 7.4.5), and this command references whichever set currently is being used.

### **kPAngle, kRAngle (Component IDs 24<sub>d</sub>, 25<sub>d</sub>)**

These outputs provide pitch and roll angles. The pitch range is -90.0° to +90.0°, and the roll range is to -180.0° to +180.0°.

### **kXAligned, kYAligned, kZAligned (Component IDs 27<sub>d</sub>, 28<sub>d</sub>, 29<sub>d</sub>)**

These values represent Earth's calibrated magnetic field (M) vector components. The default values are the factory-calibrated values. Note that up to eight (8) sets of values can be stored using kCoeffCopySet (see Section 7.4.5), and this command references whichever set currently is being used.

---

## **7.4.3 kGetData (frame ID 4<sub>d</sub>)**

This frame queries the module for data, as established in kSetDataComponents. The frame has no payload. The complete packet for the kGetData command is:

00 05	04	BF71
-------	----	------

Where “00 05” is the byte count, “04” is the kGetData command, and “BF 71” is the CRC-16 checksum.

---

## **7.4.4 kDataResp (frame ID 5<sub>d</sub>)**

This frame is the response to the kGetData frame. The first byte of the payload indicates the number of data components, followed by the data component ID-value pairs. The sequence of component IDs follows the sequence set in the kSetDataComponents frame.

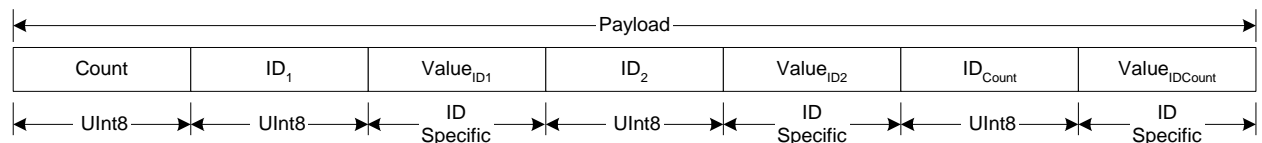



**Example:** If the response contains heading and pitch, the payload would look like:

2	5	359.9	24	10.5
ID Count	Heading ID	Heading Output (Float32)	Pitch ID	Pitch Output (Float32)

## 7.4.5 kSetConfig (frame ID 6<sub>d</sub>)

This frame sets internal configurations in the module. The first byte of the payload is the configuration ID followed by a format-specific value. These configurations can only be set one at a time.

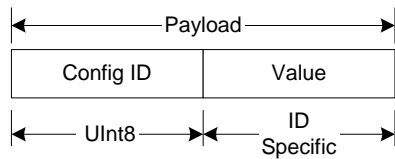

**Example:** To configure the declination, the payload would look like:

1	10.0
Declination ID	Declination Angle (Float32)

**Table 7-4: Configuration Identifiers**

Settings	Config. ID <sub>d</sub>	Format	Values / Range	Default
kDeclination	1	Float32	-180° to +180°	0°
kTrueNorth	2	Boolean	True or False	False
kBigEndian	6	Boolean	True or False	True
kMountingRef*	10	UInt8	1 = STD 0° 2 = X UP 0° 3 = Y UP 0° 4 = STD 90° 5 = STD 180° 6 = STD 270° 7 = Z DOWN 0° 8 = X UP 90° 9 = X UP 180° 10 = X UP 270° 11 = Y UP 90° 12 = Y UP 180° 13 = Y UP 270° 14 = Z DOWN 90° 15 = Z DOWN 180° 16 = Z DOWN 270°	1
kUserCalNumPoints	12	UInt32	4 – 32	12

kUserCalAutoSampling	13	Boolean	True or False	True
kBaudRate	14	UInt8	0 – 300 1 – 600 2 – 1200 3 – 1800 4 – 2400 5 – 3600 6 – 4800 7 – 7200 8 – 9600 9 – 14400 10 – 19200 11 – 28800 12 – 38400 13 – 57600 14 - 115200	12
kMilOutput	15	Boolean	True or False	False
kDataCal	16	Boolean	True or False	True
kCoeffCopySet	18	UInt32	0 - 7	0
kAccelCoeffCopySet	19	UInt32	0 - 2	0

\*Refer to Figure 4-1 for additional information on mounting orientations.

Configuration parameters and settings for kSetConfig:

#### **kDeclination (Config. ID 1<sub>d</sub>)**

This sets the declination angle to determine True North heading. Positive declination is easterly declination and negative is westerly declination. This is not applied until kTrueNorth is set to TRUE.

#### **kTrueNorth (Config. ID 2<sub>d</sub>)**

Flag to set compass heading output to true north heading by adding the declination angle to the magnetic north heading.

#### **kBigEndian (Config. ID 6<sub>d</sub>)**

Sets the Endianness of packets. TRUE is Big Endian. FALSE is Little Endian.

#### **kMountingRef (Config. ID 10<sub>d</sub>)**

This sets the reference orientation for the module. Please refer to and Figure 4-1 for additional information

#### **kUserCalNumPoints (Config. ID 12<sub>d</sub>)**

The user must select the number of points to take during a calibration. The number of sample points must be within the listed “Allowable Range” or the module may not work properly. Calibration generally is not as good if less than the “Minimum Recommended” is selected, but may be acceptable. See Section 6.2 for additional information.

**Table 7-5: Sample Points**

Calibration Mode	Number of Samples	
	Allowable Range	Minimum Recommended
Full Range	10 to 32	12
2D Calibration	10 to 32	12
Limited Tilt Range	10 to 32	12
Hard Iron Only	4 to 32	6
Accelerometer Only	12 to 32	18
Accel and Mag	12 to 32	18

**kUserCalAutoSampling (Config. ID 13<sub>d</sub>)**

This flag is used during user calibration. If set to TRUE, the module automatically takes calibration sample points once the minimum change requirement is met. If set to FALSE, the module waits for kTakeUserCalSample to take a sample with the condition that a magnetic field vector component delta is greater than 5  $\mu$ T from the last sample point. If the user wants to have maximum control over when the calibration sample point are taken then this flag should be set to FALSE.

**kBaudRate (Config. ID 14<sub>d</sub>)**

Baud rate index value. A power-down power-up cycle is required when changing the baud rate.

**kMilOutput (Config. ID 15<sub>d</sub>)**

This flag sets the heading, pitch and roll output to mils. By default, kMilOutput is set to FALSE and the heading, pitch and roll output are in degrees. Note that 360 degrees = 6400 mils, such that 1 degree = 17.778 mils or 1 mil = 0.05625 degree.

**kDataCal (Config. ID 16<sub>d</sub>)**

This flag sets whether or not heading, pitch, and roll data are output simultaneously while the TCM is being calibrated. The default is TRUE, such that heading, pitch, and roll are output during calibration. FALSE disables simultaneous output.

**kCoeffCopySet (Config. ID 18<sub>d</sub>)**

This command provides the flexibility to store up to eight (8) sets of magnetometer calibration coefficients in the module. The default is set number 0. To store a set of coefficients, first establish the set number (number 0 to 7) using kCoeffCopySet, then perform the magnetometer calibration. The coefficient values will be stored in the defined set number. This feature is useful if the compass will be placed in multiple locations that have different local magnetic field properties.

### kAccelCoeffCopySet (Config. ID 19<sub>d</sub>)

This command provides the flexibility to store up to three (3) sets of accelerometer calibration coefficients in the module. The default is set number 0. To store a set of coefficients, first establish the set number (number 0 to 2) using kAccelCoeffCopySet, then perform the accelerometer calibration. The coefficient values will be stored in the defined set number.

---

#### 7.4.6 kGetConfig (frame ID 7<sub>d</sub>)

This frame queries the module for the current internal configuration value. The payload contains the configuration ID requested.

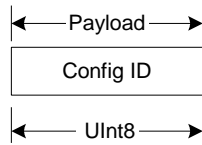

---

#### 7.4.7 kConfigResp (frame ID 8<sub>d</sub>)

This frame is the response to kGetConfig frame. The payload contains the configuration ID and value.

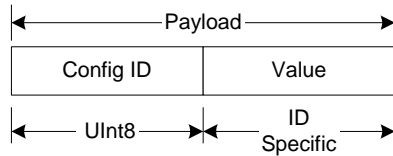

**Example:** If a request to get the set declination angle, the payload would look like:

1	10.0
Declination ID	Declination Angle (Float32)

---

#### 7.4.8 kSave (frame ID 9<sub>d</sub>)

This frame commands the module to save internal configurations and user calibration to non-volatile memory. Internal configurations and user calibration is restored on power up. The frame has no payload. This is the ONLY command that causes the module to save information into non-volatile memory.

---

## 7.4.9 kStartCal (frame ID 10d)

This frame commands the module to start user calibration with the current sensor acquisition parameters, internal configurations and FIR filter settings. After sending this command, the module ensures the stability condition is met, takes the first calibration point, and then responds with kUserCalSampCount. kUserCalSampCount will continue to be sent after each sample is taken. (Subsequent samples will be taken when autosampling when the minimum change and stability conditions are met, or manually after the kTakeUserCalSample is sent and the stability condition is met.) See Section 6.2 for more information on the various calibration procedures.

---

*Note: The payload needs to be 32 bit (4 byte). If no payload is entered or if less than 4 bytes are entered, the unit will default to the previous calibration method.*

---

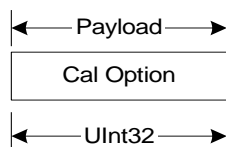

The CalOption values are given below, along with basic descriptions of the options.

### **Full Range Calibration - magnetic only (10<sub>d</sub> = 0A<sub>h</sub>)**

Recommended calibration method when >45° of tilt is possible.

### **2D Calibration - magnetic only (20<sub>d</sub> = 14<sub>h</sub>)**

Recommended when the available tilt range is limited to ≤5°.

### **Hard Iron Only Calibration - magnetic only (30<sub>d</sub> = 1E<sub>h</sub>)**

Recalibrates the hard iron offset for a prior calibration. If the local field hard iron distortion has changed, this calibration can bring the module back into specification.

### **Limited Tilt Range Calibration – magnetic only (40<sub>d</sub> = 28<sub>h</sub>)**

Recommended calibration method when >5° of tilt calibration is available, but tilt is restricted to <45°. (i.e. full range calibration is not possible.)

### **Accelerometer Only Calibration (100<sub>d</sub> = 64<sub>h</sub>)**

Select this when only accelerometer calibration will be performed.

### **Accelerometer and Magnetic Calibration (110<sub>d</sub> = 6E<sub>h</sub> = )**

Selected when magnetic and accelerometer calibration will be done simultaneously.

Below is a complete sample frame for a 2D Calibration:

```
00 09 0A 00 00 00 14 5C F9
```

Heading, pitch and roll information a output via the kDataResp frame during the calibration process. This feature provides guidance during the calibration regarding calibration sample point coverage. During calibration, in the kDataResp frame, the number of data components is set to be 3 and then followed by the data component ID-value pairs. The sequence of the component IDs are kHeading, kPAngle and kRAngle.

---

#### 7.4.10 kStopCal (frame ID 11d)

This command aborts the calibration process and is not required to generally stop a calibration process. Assuming the minimum number of sample points for the calibration (as defined in Table 7-5) is not acquired prior to sending kStopCal, the prior calibration results are retained. If the acquired number of sample points prior to sending kStopCal is within the allowable range of kUserCalNumPoints, then new calibration coefficients and a new score will be generated. For instance, if kUserCalNumPoints is set to 32 for a full range calibration, and kStopCal is sent after taking the 12<sup>th</sup> sample point, then a new set of coefficients will be generated based on the 12 sample points that were taken.

---

#### 7.4.11 kSetParam (frame ID 12d)

The TCM incorporates a finite impulse response (FIR) filter to provide a more stable heading reading. The number of taps (or samples) represents the amount of filtering to be performed. Selecting a larger number of taps can significantly slow the time for the initial sample reading and, if “Flush Filters” is selected, the rate at which data is output.

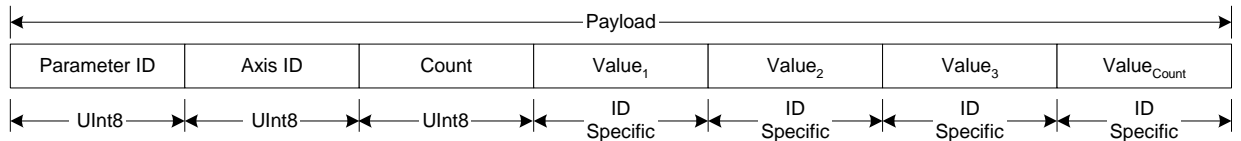

Parameter ID should be set to 3 and the Axis ID should be set to 1. The third payload byte indicates the number of FIR taps to use, which can be 0 (no filtering), 4, 8, 16, or 32. This is followed by the tap values (0 to 32 total Values can be in the payload), with each Value being a Float64, and suggested values given in Table 7-6.

**Table 7-6: Recommended FIR Filter Tap Values**

Count	4 Tap Filter	8 Tap Filter	16 Tap Filter	32 Tap Filter
1	04.6708657655334e-2	01.9875512449729e-2	07.9724971069144e-3	01.4823725958818e-3
2	04.5329134234467e-1	06.4500864832660e-2	01.2710056429342e-2	02.0737124095482e-3
3	04.5329134234467e-1	01.6637325898141e-1	02.5971390034516e-2	03.2757326624196e-3
4	04.6708657655334e-2	02.4925036373620e-1	04.6451949792704e-2	05.3097803863757e-3
5		02.4925036373620e-1	07.1024151197772e-2	08.3414139286254e-3
6		01.6637325898141e-1	09.5354386848804e-2	01.2456836057785e-2
7		06.4500864832660e-2	01.1484431942626e-1	01.7646051430536e-2
8		01.9875512449729e-2	01.2567124916369e-1	02.3794805168613e-2
9			01.2567124916369e-1	03.0686505921968e-2
10			01.1484431942626e-1	03.8014333463472e-2
11			09.5354386848804e-2	04.5402682509802e-2
12			07.1024151197772e-2	05.2436112653103e-2
13			04.6451949792704e-2	05.8693165018301e-2
14			02.5971390034516e-2	06.3781858267530e-2
15			01.2710056429342e-2	06.7373451424187e-2
16			07.9724971069144e-3	06.9231186101853e-2
17				06.9231186101853e-2
18				06.7373451424187e-2
19				06.3781858267530e-2
20				05.8693165018301e-2
21				05.2436112653103e-2
22				04.5402682509802e-2
23				03.8014333463472e-2
24				03.0686505921968e-2
25				02.3794805168613e-2
26				01.7646051430536e-2
27				01.2456836057785e-2
28				08.3414139286254e-3
29				05.3097803863757e-3
30				03.2757326624196e-3
31				02.0737124095482e-3
32				01.4823725958818e-3

---

### 7.4.12 kGetParam (frame ID 13<sub>d</sub>)

This frame queries the FIR filter settings for the sensors. Parameter ID should be set to 3 and the Axis ID should be set to 1.

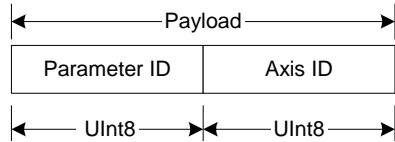

---

### 7.4.13 kParamResp (frame ID 14<sub>d</sub>)

This frame contains the current FIR filter settings. The format and values will be the same as defined by kSetParam.

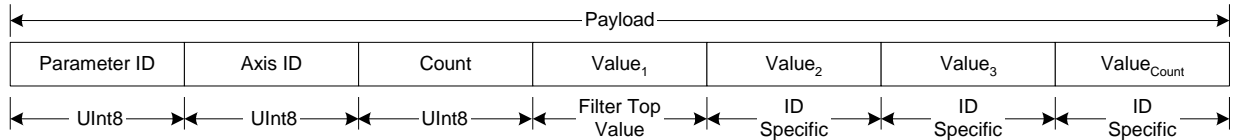

---

### 7.4.14 kPowerDown (frame ID 15<sub>d</sub>)

This frame is used to completely power-down the module, which is referred to as putting the module in Sleep Mode. The frame has no payload. The module will power down all peripherals including the RS-232 driver but the driver chip has the feature to keep the Rx line enabled. Any character sent to the module causes it to exit power down mode. It is recommended to send the byte 0xFFh.

---

### 7.4.15 kSaveDone (frame ID 16<sub>d</sub>)

This frame is the response to kSave frame. The payload contains a UInt16 error code, 0000h indicates no error, 0001h indicates error when attempting to save data into non-volatile memory.

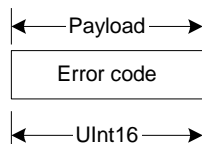



---

### 7.4.16 kUserCalSampCount (frame ID 17<sub>d</sub>)

This frame is sent from the module after taking a calibration sample point. The payload contains the sample count with the range of 1 to 32.

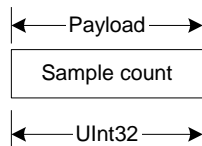

---

### 7.4.17 kUserCalScore (frame ID 18<sub>d</sub>)

This frame's payload contains the calibration score, which is a series of Float32 values: CalScore, Calparam2, Calparam3, DistErr, TiltErr, TiltRange.

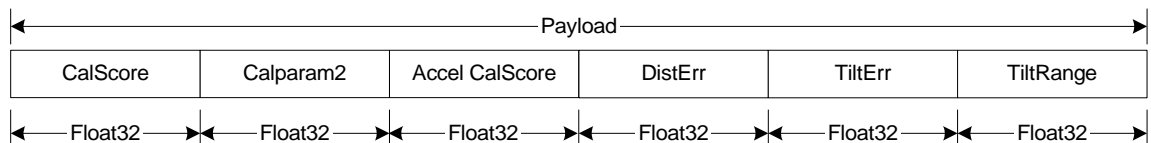

#### **CalScore (Mag CalScore):**

Represents the over-riding indicator of the quality of the magnetometer calibration. Acceptable scores will be  $\leq 1$  for full range calibration,  $\leq 2$  for other methods. Note that it is possible to get acceptable scores for DistErr and TiltErr and still have a rather high Mag CalScore value. The most likely reason for this is the TCM is close to a source of local magnetic distortion that is not fixed with respect to the module.

#### **Calparam2:**

Reserved values for PNI use.

#### **Calparam3 (Accel CalScore):**

Represents the over-riding indicator of the quality of the accelerometer calibration. An acceptable score is  $\leq 1$ .

#### **DistErr:**

Indicates the quality of the sample point distribution, primarily looking for an even yaw distribution. Significant clumping or a lack of sample points in a particular section can result in a poor score. The score should be  $\leq 1$ .

#### **TiltErr:**

Indicates the contribution to the CalScore caused by tilt or lack thereof. The score takes into account the calibration method. The score should be  $\leq 1$ .

## TiltRange:

This reports the larger of either half the full pitch range or half the full roll range of sample points. For example, if the module is pitched  $+10^\circ$  to  $-20^\circ$ , and rolled  $+25^\circ$  to  $-15^\circ$ , the Tilt Range value would be  $20^\circ$  (as derived from  $[+25^\circ - \{-15^\circ\}]/2$ ). For Full Range Calibration and Hard Iron Only Calibration, this should be  $\geq 45^\circ$ . For 2D Calibration, this ideally should be  $\approx 2^\circ$ . For Limited Tilt Range Calibration the value should be as large as possible given the user's constraints.

---

### 7.4.18 kSetConfigDone (frame ID 19<sub>d</sub>)

This frame is the response to kSetConfig frame. The frame has no payload.

---

### 7.4.19 kSetParamDone (frame ID 20<sub>d</sub>)

This frame is the response to kSetParam frame. The frame has no payload.

---

### 7.4.20 kStartIntervalMode (frame ID 21<sub>d</sub>)

This frame commands the module to output data at a fixed time interval, otherwise known as Push mode. See kSetAcqParams. The frame has no payload.

---

### 7.4.21 kStopIntervalMode (frame ID 22<sub>d</sub>)

This frame commands the module to stop data output when in Push mode. The frame has no payload.

---

### 7.4.22 kPowerUp (frame ID 23<sub>d</sub>)

This frame is sent from the module after waking up from Sleep Mode. The frame has no payload. Since the module was previously powered down which drives the RS-232 driver TX line low (break signal), it is recommended to disregard the first byte.

---

### 7.4.23 kSetAcqParams (frame ID 24<sub>d</sub>)

This frame sets the sensor acquisition parameters in the module. The payload should contain the following:

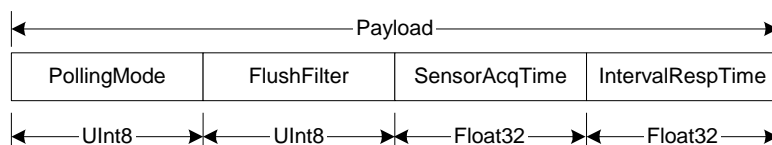

**PollingMode:**

This flag sets whether output will be presented in Poll or Push mode. Poll mode is TRUE and is the default. Poll mode should be selected when the host system will poll the TCM for data. Push mode should be selected if the user will have the TCM output data at a relatively fixed rate to the host system. See `kStartIntervalMode` for starting a Push Mode command.

**FlushFilter:**

Setting this flag to TRUE will result in the FIR filters being flushed (reset) after every sample. The default is FALSE (no flushing).

The filtering is set to only update the filter with the last sample taken, for example once the initial 32 samples are taken (assuming FIR Taps is set to the default value of 32) any new sample is added to the end with the first sample being dropped. In the case where `SensorAcqTime` is set to a value it would be prudent to set the module to flush the filter prior to calculating the heading. This flushing will require the module to take 32 new samples to use for the calculation.

**SensorAcqTime:**

The `SensorAcqTime` sets the time between samples taken by the module, in seconds. The default is 0.0 seconds, which means that the module will reacquire data immediately after the last acquisition. This is an internal setting that is NOT tied to the time with which the module transmits data to the host system. Generally speaking, the `SensorAcqTime` is either set to 0, in which case the TCM is constantly sampling, or set to equal the `IntervalRespTime` value. The advantage of running with an `SensorAcqTime` of 0 is the FIR filter can run with a relatively high FIR Tap value to provide stable and timely data. The advantage of using a greater `SensorAcqTime` is power consumption can be reduced, assuming the `IntervalRespTime` is no less than the `SensorAcqTime`.

**IntervalRespTime:**

The `IntervalRespTime` is relevant when Push Mode is selected, and is the time delay, in seconds, between completion of the TCM module sending one set of sampled data and the start of sending the next sample set. The default is 0.0 seconds, which means the TCM will begin sending new data as soon as the previous data set has been sent. Note that the inverse of the `IntervalRespTime` is somewhat greater than the sample rate, since the `IntervalRespTime` does not include actual acquisition time

---

**7.4.24 kGetAcqParams (frame ID 25<sub>d</sub>)**

This frame queries the unit for acquisition parameters. The frame has no payload.

---

#### **7.4.25 kAcqParamsDone (frame ID 26<sub>d</sub>)**

This frame is the response to kSetAcqParams frame. The frame has no payload.

---

#### **7.4.26 kAcqParamsResp (frame ID 27<sub>d</sub>)**

This frame is the response to kGetAcqParams frame. The payload should contain the same payload as the kSetAcqParams frame.

---

#### **7.4.27 kPowerDownDone (frame ID 28<sub>d</sub>)**

This frame is the response to kPowerDown frame. This indicates that the module successfully received the kPowerDone frame and is in the process of powering down. The frame has no payload.

---

#### **7.4.28 kFactoryUserCal (frame ID 29<sub>d</sub>)**

This frame clears the user magnetometer calibration coefficients. The frame has no payload. This frame must be followed by the kSave frame to change in non-volatile memory.

---

#### **7.4.29 kFactoryUserCalDone (frame ID 30<sub>d</sub>)**

This frame is the response to kFactoryUserCal frame. The frame has no payload.

---

#### **7.4.30 kTakeUserCalSample (frame ID 31<sub>d</sub>)**

This frame commands the module to take a sample during user calibration. The frame has no payload.

---

#### **7.4.31 kFactoryInclCal (frame ID 36<sub>d</sub>)**

This frame clears the user accelerometer calibration coefficients. The frame has no payload. This frame must be followed by the kSave frame to change in non-volatile memory.

---

#### **7.4.32 kFactoryInclCalDone (frame ID 37<sub>d</sub>)**

This frame is the response to kFactoryInclCal frame. The frame has no payload.

---

### 7.4.33 kSetMode (frame ID 46<sub>d</sub>)

*Note: When Sync Mode is selected, the TCM will acknowledge the change in mode and immediately trigger the Sync Mode and send a data frame.*

---

This frame allows the module to be placed in Sync Mode. When in Sync Mode the module will stay in Sleep Mode until the user's system sends a trigger to report data. When so triggered, the TCM will wake up, report data once, then return to Sleep Mode. One application of this is to lower power consumption. Another use of the Sync Mode is to trigger a reading during an interval when local magnetic sources are well understood. For instance, if a system has considerable magnetic noise due to nearby motors, the Sync Mode can be used to take measurements when the motors are turned off.

The payload contains the Mode ID requested, as given below.

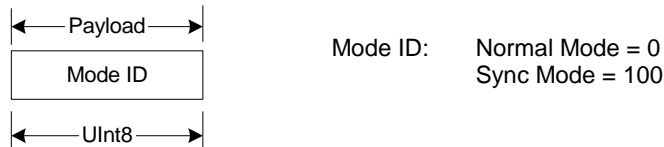

If the module is in Sync Mode and the user desires to switch back to Normal Mode, an “FF<sub>h</sub>” string first must be sent, followed by some minimum delay time prior to sending the kSetMode frame. The minimum delay time is dependent on the baud rate, and for a baud rate equal to or slower than 9600 there is no delay. For baud rates greater than 9600 the minimum delay is equal to:

$$\text{Minimum delay after sending “FF}_h\text{” (in seconds)} = 7E-3 - (10/\text{baud rate})$$

For example, with a baud rate of 38400, the minimum delay after sending “FF<sub>h</sub>” is:

$$\text{Minimum delay at 38400 baud} = 7E-4 - (10/38400) = 4.4E-4 \text{ seconds} = 440 \mu\text{s}$$

Sync Mode generally is intended for applications in which sampling does not occur frequently. For applications where Sync Mode sampling will be at a frequency of 1 Hz or higher, there is a minimum allowable delay between taking samples. This minimum delay between samples (approximately inverse to the maximum sample rate) varies from 100 msec to 1.06 second and is a function of the number of FIR filter taps, as defined by the following formula:

$$\text{Minimum Delay between Samples (in seconds)} = 0.1 + 0.03 * (\text{number of Taps})$$

---

### 7.4.34 kSetModeResps (frame ID 47<sub>d</sub>)

This frame is the response to kSetMode frame. The payload contains the Mode ID requested.

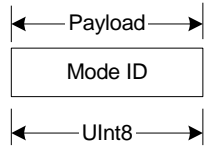

---

### 7.4.35 kSyncRead (frame ID 49<sub>d</sub>)

This frame requests a reading from the module when the unit is in Sync Mode. This frame has no payload. The response to this frame is kDataResp, with heading, pitch, and roll set as the sequence of data component IDs.

Prior to sending the kSyncRead frame, the user's system must first send an "FF<sub>h</sub>" string which wakes up the system, then wait some minimum delay time before sending the kSyncRead frame. The minimum delay time is dependent on the baud rate, and for a baud rate equal to or slower than 9600 there is no delay. The minimum delay is defined by the same formula given for switching from Sync Mode to Normal Mode in kSetMode.

---

## 7.5 Code Examples

The following example files, CommProtocol.h, CommProtocol.cp, TCM.h and TCM.cp would be used together for proper communication with a TCM module.

---

*Note: The following files are not included in the sample codes and need to be created by the user: Processes.h & TickGenerator.h. The comments in the code explain what is needed to be sent or received from these functions so the user can write this section for the user's platform. For example, with the TickGenerator.h, the user needs to write a routing that generates 10 msec ticks.*

---

### 7.5.1 Header File & CRC-16 Function

```
// type declarations
typedef struct
{
    UInt8 pollingMode, flushFilter;
    Float32 sensorAcqTime, intervalRespTime;
} __attribute__((packed)) AcqParams;

typedef struct
{
    Float32 MagCalScore;
    Float32 reserve1;
    Float32 AccelCalScore;
    Float32 DistErr;
    Float32 TiltErr;
    Float32 TiltRange;
} __attribute__((packed)) CalScore;

enum
{
    // Frame IDs (Commands)
    kGetModInfo = 1, // 1
    kModInfoResp, // 2
    kSetDataComponents, // 3
    kGetData, // 4
    kDataResp, // 5
    kSetConfig, // 6
    kGetConfig, // 7
    kConfigResp, // 8
    kSave, // 9
    kStartCal, // 10
    kStopCal, // 11
    kSetParam, // 12
    kGetParam, // 13
    kParamResp, // 14
    kPowerDown, // 15
    kSaveDone, // 16
    kUserCalSampCount, // 17
    kUserCalScore, // 18
    kSetConfigDone, // 19
    kSetParamDone, // 20
}
```

```

kStartIntervalMode,    // 21
kStopIntervalMode,    // 22
kPowerUp,              // 23
kSetAcqParams,        // 24
kGetAcqParams,        // 25
kAcqParamsDone,       // 26
kAcqParamsResp,       // 27
kPowerDoneDown,       // 28
kFactoryUserCal,      // 29
kFactoryUserCalDone,  // 30
kTakeUserCalSample,   // 31
kFactoryInclCal = 36, // 36
kFactoryInclCalDone, // 37
kSetMode = 46,        // 46
kSetModeDone,         // 47
kSyncRead = 49,       // 49

// Cal Option IDs
kFullRangeCal = 10,   // 10 - type Float32
k2DCal = 20,          // 20 - type Float32
kHIOOnlyCal = 30,    // 30 - type Float32
kLimitedTiltCal = 40, // 40 - type Float32
kAccelCalOnly = 100, // 100 - type Float32
kAccelCalwithMag = 110, // 110 - type Float32

// Param IDs
kFIRConfig = 3,
// 3- AxisID(UInt8)+Count(UInt8)+Value(Float64)+...

// Data Component IDs
kHeading = 5,        // 5 - type Float32
kTemperature = 7,    // 7 - type Float32
kDistortion = 8,     // 8 - type boolean
kPAligned = 21,      // 21 - type Float32
kRAligned, // 22 - type Float32
kIZAligned, // 23 - type Float32
kPAngle, // 24 - type Float32
kRAngle, // 25 - type Float32
kXAligned = 27,      // 27 - type Float32
kYAligned, // 28 - type Float32
kZAligned, // 29 - type Float32

// Configuration Parameter IDs
kDeclination = 1,    // 1 - type Float32
kTrueNorth, // 2 - type boolean
kMountingRef = 10,   // 10 - type UInt8
kUserCalStableCheck, // 11 - type boolean
kUserCalNumPoints, // 12 - type UInt32
kUserCalAutoSampling, // 13 - type boolean
kBaudRate, // 14 - UInt8
kMilOutPut = 15,    // 15 - type Boolean
kDataCal // 16 - type Boolean
kCoeffCopySet = 18, // 18 - type UInt32
kAccelCoeffCopySet, // 19 - type UInt32

```



```

// Mounting Reference IDs
kMountedStandard = 1, // 1
kMountedXUp,      // 2
kMountedYUp,      // 3
kMountedStdPlus90, // 4
kMountedStdPlus180, // 5
kMountedStdPlus270, // 6
kMountedZDown // 7
kMountedXUpPlus90 // 8
kMountedXUpPlus180 // 9
kMountedXUpPlus270 // 10
kMountedYUpPlus90 // 11
kMountedYUpPlus180 // 12
kMountedYUpPlus270 // 13
kMountedZDownPlus90 // 14
kMountedZDownPlus180 // 15
kMountedZDownPlus270 // 16

// Result IDs
kErrNone = 0, // 0
kErrSave, // 1
};

// function to calculate CRC-16
UInt16 CRC(void * data, UInt32 len)
{
    UInt8 * dataPtr = (UInt8 *)data;
    UInt32 index = 0;
    // Update the CRC for transmitted and received data using
    // the CCITT 16bit algorithm (X^16 + X^12 + X^5 + 1).
    UInt16 crc = 0;
    while(len--)
    {
        crc = (unsigned char)(crc >> 8) | (crc << 8);
        crc ^= dataPtr[index++];
        crc ^= (unsigned char)(crc & 0xff) >> 4;
        crc ^= (crc << 8) << 4;
        crc ^= ((crc & 0xff) << 4) << 1;
    }
    return crc;
}

```

---

## 7.5.2 CommProtocol.h File

```
#pragma once

#include "SystemSerPort.h"
#include "Processes.h"

//
//CommHandler is a base class that provides a callback for
//incoming messages.
//
class CommHandler
{
public:
    // Call back to be implemented in derived class.
    virtual void HandleComm(UInt8 frameType, void * dataPtr =
NULL, UInt16 dataLen = 0) {}
};

//
// CommProtocol handles the actual serial communication with the //
module.
// Process is a base class that provides CommProtocol with
// cooperative parallel processing. The Control method will be
// called by a process manager on a continuous basis.
//
class CommProtocol : public Process
{
public:
    enum
    {
        // Frame IDs (Commands)
        kGetModInfo = 1,           // 1
        kModInfoResp,           // 2
        kSetDataComponents,     // 3
        kGetData,               // 4
        kDataResp,              //5

        // Data Component IDs
        kHeading = 5,           // 5 - type Float32
        kTemperature = 7,       // 7 - type Float32
        kPAligned = 21,         // 21 - type Float32
        kRAligned,              // 22 - type Float32
        kIZAligned,             // 23 - type Float32
        kPAngle,                // 24 - type Float32
        kRAngle,                // 25 - type Float32
    };

    enum
    {
        kBufferSize = 512,
    };
};
```

```

// maximum size of our input buffer
    kPacketMinSize = 5
// minimum size of a serial packet
    };

// SerPort is a serial communication object abstracting
// the hardware implementation
    CommProtocol(CommHandler * handler = NULL, SerPort *
serPort = NULL);

    void Init(UInt32 baud = 38400);

    void SendData(UInt8 frame, void * dataPtr = NULL, UInt32
len = 0);
    void SetBaud(UInt32 baud);

protected:
    CommHandler * mHandler;
    SerPort * mSerialPort;

    UInt8 mOutData[kBufferSize], mInData[kBufferSize];
    UInt16 mExpectedLen;
    UInt32 mOutLen, mOldInLen, mTime, mStep;

    UInt16 CRC(void * data, UInt32 len);
    void Control();
};

```

---

### 7.5.3 CommProtocol.cpp File

```
#include "CommProtocol.h"

// import an object that will provide a 10mSec tick count through
// a function called Ticks()
#include "TickGenerator.h"

// SerPort is an object that controls the physical serial
// interface. It handles sending out
// the characters, and buffers the characters read in until
// we are ready for them.
//
CommProtocol::CommProtocol(CommHandler * handler, SerPort * serPort)
    : Process("CommProtocol")
{
    mHandler = handler;
    // store the object that will parse the data when it is fully
    // received
    mSerialPort = serPort;
    Init();
}

// Initialize the serial port and variables that will control
// this process
void CommProtocol::Init(UInt32 baud)
{
    SetBaud(baud);
    mOldInLen = 0;
    // no data previously received
    mStep = 1;
    // goto the first step of our process
}

//
// Put together the frame to send to the module
//
void CommProtocol::SendData(UInt8 frameType, void * dataPtr, UInt32
len)
{
    UInt8 * data = (UInt8 *)dataPtr;          // the data to send
    UInt32 index = 0;
    // our location in the frame we are putting together
    UInt16 crc;
    // the CRC to add to the end of the packet
    UInt16 count;
    // the total length the packet will be

    count = (UInt16)len + kPacketMinSize;

    // exit without sending if there is too much data to fit
    // inside our packet
```

```

        if(len > kBufferSize - kPacketMinSize) return;

// Store the total len of the packet including the len bytes
// (2), the frame ID (1),
// the data (len), and the crc (2). If no data is sent, the
// min len is 5
    mOutData[index++] = count >> 8;
    mOutData[index++] = count & 0xFF;

    // store the frame ID
    mOutData[index++] = frameType ;

    // copy the data to be sent
    while(len--) mOutData[index++] = *data++;

    // compute and add the crc
    crc = CRC(mOutData, index);
    mOutData[index++] = crc >> 8 ;
    mOutData[index++] = crc & 0xFF ;

    // Write block will copy and send the data out the serial port
    mSerialPort->WriteBlock(mOutData, index);
}

```

```

//
// Call the functions in serial port necessary to change the
// baud rate
//
void CommProtocol::SetBaud(UInt32 baud)
{
    mSerialPort->SetBaudRate(baud);
    mSerialPort->InClear();
// clear any data that was already waiting in the buffer
}

```

```

//
// Update the CRC for transmitted and received data using the
// CCITT 16bit algorithm ( $X^{16} + X^{12} + X^5 + 1$ ).
//

```

```

UInt16 CommProtocol::CRC(void * data, UInt32 len)
{
    UInt8 * dataPtr = (UInt8 *)data;
    UInt32 index = 0;

    UInt16 crc = 0;
    while(len--)
    {
        crc = (unsigned char)(crc >> 8) | (crc << 8);
        crc ^= dataPtr[index++];
        crc ^= (unsigned char)(crc & 0xff) >> 4;
        crc ^= (crc << 8) << 4;
    }
}

```

```

        crc ^= ((crc & 0xff) << 4) << 1;
    }
    return crc;
}

//
// This is called each time this process gets a turn to execute.
//
void CommProtocol::Control()
{
    // InLen returns the number of bytes in the input buffer of
    //the serial object that are available for us to read.
    UInt32 inLen = mSerialPort->InLen();

    switch(mStep)
    {
        case 1:
        {
            // wait for length bytes to be received by the serial object
            if(inLen >= 2)
            {
                // Read block will return the number of requested (or available)
                // bytes that are in the serial objects input buffer.
                // read the byte count
                mSerialPort->ReadBlock(mInData, 2);

                // byte count is ALWAYS transmitted in big endian, copy byte
                // count to mExpectedLen to native endianness
                mExpectedLen = (mInData[0] << 8) |
mInData[1];

                // Ticks is a timer function. 1 tick = 10msec.
                // wait up to 1/2s for the complete frame (mExpectedLen) to be
                // received
                mTime = Ticks() + 50 ;
                mStep++;
            }
            // goto the next step in the process
            break ;
        }

        case 2:
        {
            // wait for msg complete or timeout
            if(inLen >= mExpectedLen - 2)
            {
                UInt16 crc, crcReceived;
            }
            // calculated and received crcs.

            // Read block will return the number of
            // requested (or available) bytes that are in the
            // serial objects input buffer.
            mSerialPort->ReadBlock(&mInData[2],
mExpectedLen - 2);

```

```

// in CRC verification, don't include the CRC in the recalculation
(-2)
        crc = CRC(mInData, mExpectedLen - 2);
// CRC is also ALWAYS transmitted in big endian
        crcReceived = (mInData[mExpectedLen - 2] <<
8) | mInData[mExpectedLen - 1] ;

        if(crc == crcReceived)
        {
// the crc is correct, so pass the frame up for processing.
                if(mHandler)                                mHandler->
HandleComm(mInData[2], &mInData[3], mExpectedLen - kPacketMinSize);
        }
        else
        {
// crc's don't match so clear everything that is currently in the
// input buffer since the data is not reliable.
                mSerialPort->InClear();
        }

// go back to looking for the length bytes.
        mStep = 1 ;
    }
    else
    {
// Ticks is a timer function. 1 tick = 10msec.
        if(Ticks() > mTime)
        {
// Corrupted message. We did not get the length we were
// expecting within 1/2sec of receiving the length bytes. Clear
// everything in the input buffer since the data is unreliable
                mSerialPort->InClear();
                mStep = 1 ;
// Look for the next length bytes
        }
    }
    break ;
}

default:
    break ;
}
}

```

---

## 7.5.4 TCM.h File

```
#pragma once

#include "Processes.h"
#include "CommProtocol.h"

//
// This file contains the object providing communication to the
// TCM. It will set up the module and parse packets received
// Process is a base class that provides TCM with cooperative
// parallel processing. The Control method will be
// called by a process manager on a continuous basis.
//
class TCM : public Process, public CommHandler
{
public:
    TCM(SerPort * serPort);
    ~TCM();

protected:
    CommProtocol * mComm;

    UInt32 mStep, mTime, mResponseTime;

    void HandleComm(UInt8 frameType, void * dataPtr = NULL,
        UInt16 dataLen = 0);
    void SendComm(UInt8 frameType, void * dataPtr = NULL,
        UInt16 dataLen = 0);

    void Control();
};
```



---

## 7.5.5 TCM.cpp File

```
#include "TCM.h"
#include "TickGenerator.h"

const UInt8 kDataCount = 4;
// We will be requesting 4 componets (Heading, pitch, roll,
// temperature)
//
// This object polls the TCM module once a second for
// heading, pitch, roll and temperature.
//

TCM::TCM(SerPort * serPort)
    : Process("TCM")
{
    // Let the CommProtocol know this object will handle any
    // serial data returned by the module
    mComm = new CommProtocol(this, serPort);

    mTime = 0;
    mStep = 1;
}

TCM::~TCM()
{
}

//
// Called by the CommProtocol object when a frame is completely //
// received
//
void TCM::HandleComm(UInt8 frameType, void * dataPtr, UInt16
dataLen)
{
    UInt8 * data = (UInt8 *)dataPtr;

    switch(frameType)
    {
        case CommProtocol::kDataResp:
        {
            // Parse the data response
            UInt8 count = data[0];
            // The number of data elements returned
            UInt32 pnter = 1;
            // Used to retrieve the returned elements

            // The data elements we requested
            Float32 heading, pitch, roll, temperature;

            if(count != kDataCount)
            {

```

```

    // Message is a function that displays a C formatted string
    // (similar to printf)
    Message("Received %u data elements instead of
the %u requested\r\n", (UInt16)count,
    (UInt16)kDataCount);
    return;
}

// loop through and collect the elements
while(count)
{
    // The elements are received as {type (ie. kHeading), data}
    switch(data[pntr++])
// read the type and go to the first byte of the data
    {
        // Only handling the 4 elements we are looking for
        case CommProtocol::kHeading:
            {
                // Move(source, destination, size (bytes)). Move copies the
                // specified number of bytes from the source pointer to the
                // destination pointer. Store the heading.
                Move(&(data[pntr]), &heading,
sizeof(heading));

                // increase the pointer to point to the next data element type
                pntr += sizeof(heading);
                break;
            }

            case CommProtocol::kPAngle:
            {
                // Move(source, destination, size (bytes)). Move copies the
                // specified number of bytes from the source pointer to the
                // destination pointer. Store the pitch.
                Move(&(data[pntr]), &pitch,
sizeof(pitch));

                // increase the pointer to point to the next data element type
                pntr += sizeof(pitch);
                break;
            }

            case CommProtocol::kRAngle:
            {
                // Move(source, destination, size (bytes)). Move copies the
                // specified number of bytes from the source pointer to the
                // destination pointer. Store the roll.
                Move(&(data[pntr]), &roll,
sizeof(roll));

                // increase the pointer to point to the next data element type
                pntr += sizeof(roll);
                break;
            }
    }
}

```

```

        case CommProtocol::kTemperature:
        {
            // Move(source, destination, size (bytes)). Move copies the
            // specified number of bytes from the source pointer to the
            // destination pointer. Store the heading.
            Move(&(data[pntr]), &temperature,
sizeof(temperature));

            // increase the pointer to point to the next data element type
            pntr += sizeof(temperature);
            break;
        }

        default:
            // Message is a function that displays a formatted string
            // (similar to printf)
            Message("Unknown type: %02X\r\n",
data[pntr - 1]);
            // unknown data type, so size is unknown, so skip everything
            return;
            break;
        }

        count--;
// One less element to read in
    }

    // Message is a function that displays a formatted string
    // (similar to printf)
    Message("Heading: %f, Pitch: %f, Roll: %f,
Temperature: %f\r\n", heading, pitch, roll,
temperature);
    mStep--;
    // send next data request
    break;
}

default:
{
    // Message is a function that displays a formatted string
    // (similar to printf)
    Message("Unknown frame %02X received\r\n",
(UInt16)frameType);
    break;
}
}

//
// Have the CommProtocol build and send the frame to the module.
//
void TCM::SendComm(UInt8 frameType, void * dataPtr, UInt16 dataLen)
{

```

```

        if(mComm) mComm->SendData(frameType, dataPtr, dataLen);
// Ticks is a timer function. 1 tick = 10msec.
        mResponseTime = Ticks() + 300;           // Expect a response
within 3 seconds
    }
//
// This is called each time this process gets a turn to execute.
//
void TCM::Control()
{
    switch(mStep)
    {
        case 1:
        {
            UInt8 pkt[kDataCount + 1];
// the compents we are requesting, preceded by the number of
// components being requested

            pkt[0] = kDataCount;
            pkt[1] = CommProtocol::kHeading;
            pkt[2] = CommProtocol::kPAngle;
            pkt[3] = CommProtocol::kRAngle;
            pkt[4] = CommProtocol::kTemperature;

            SendComm(CommProtocol::kSetDataComponents,      pkt,
kDataCount + 1);

            // Ticks is a timer function. 1 tick = 10msec.
            mTime = Ticks() + 100;
// Taking a sample in 1s.
            mStep++;
// go to next step of process
            break;
        }

        case 2:
        {
// Ticks is a timer function. 1 tick = 10msec.
            if(Ticks() > mTime)
            {
// tell the module to take a sample
                SendComm(CommProtocol::kGetData);
                mTime = Ticks() + 100; // take a sample every
second

                mStep++;
            }
            break;
        }

        case 3:
        {
// Ticks is a timer function. 1 tick = 10msec.
            if(Ticks() > mResponseTime)
            {

```

```
        Message("No response from the module. Check
connection and try again\r\n");
        mStep = 0;
    }
    break;
}

default:
    break;
}
}
```