

**Metallized Polypropylene (PP) - DC-Link Capacitors for STRINGENT REQUIREMENTS. Capacitances from 0.47  $\mu\text{F}$  to 80  $\mu\text{F}$ . Rated Voltages from 450 VDC to 1050 VDC.**

## Special Features

- Capacitances up to 80  $\mu\text{F}$
- High volume/capacitance ratio
- Excellent self-healing properties
- For stringent requirements
- Very low dissipation factor
- High reliability
- 2-pin and 4-pin contact configuration (plate versions on request)
- According to RoHS 2011/65/EU

## Typical Applications

As intermediate circuit capacitor e.g. in high power converter technology, power supplies, solar inverters etc.

## Construction

### Dielectric:

Polypropylene (PP) film

### Capacitor electrodes:

Vacuum-deposited

### Internal construction:

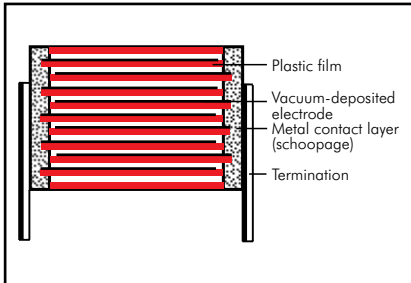

### Encapsulation:

Solvent-resistant, flame-retardant plastic case with epoxy resin seal, UL 94 V-0

### Terminations:

Tinned wire (plate versions on request).

### Marking:

Colour: Red. Marking: Black.

Epoxy resin seal: Red

## Electrical Data

**Capacitance range:** 0.47  $\mu\text{F}$  to 80  $\mu\text{F}$  (intermediate values on request)

**Rated voltages:** 450 VDC, 630 VDC, 800 VDC, 900 VDC, 1050 VDC

**Capacitance tolerances:**  $\pm 20\%$ ,  $\pm 10\%$ ,  $\pm 5\%$

**Operating temperature range:**  $-55^\circ\text{C}$  to  $+105^\circ\text{C}$  (hot spot including self-heating)

**Climatic test category:** 55/085/56 in accordance with IEC

**Dissipation factors** at  $+20^\circ\text{C}$ :

PCM	1 kHz
27.5	$\leq 12 \times 10^{-4}$
37.5	$\leq 25 \times 10^{-4}$
52.5	$\leq 45 \times 10^{-4}$

### Voltage and current derating:

A derating factor of 1.35% per K must be applied from  $+85^\circ\text{C}$  for DC voltages and from  $+70^\circ\text{C}$  for AC currents ( $I_{\text{rms}}$ ). Additionally a derating factor of 4.5% per K must be applied from  $+85^\circ\text{C}$  for AC currents ( $I_{\text{rms}}$ )

**Reliability:** Operational life  $> 100\,000$  hours ( $U_r$  and  $70^\circ\text{C}$ )

Failure rate  $\lambda_0$  ( $10.5 \times U_r$  and  $40^\circ\text{C}$ )

$\Pi =  C_N [\mu\text{F}] \times U_r [\text{V}] $	$\lambda_0$
$\Pi \leq 10\,000$	$< 2$ fit
$10\,000 < \Pi \leq 25\,000$	$< 5$ fit
$25\,000 < \Pi \leq 50\,000$	$< 10$ fit
$50\,000 < \Pi \leq 100\,000$	$< 20$ fit
$\Pi > 100\,000$	$< 30$ fit

### Maximum pulse rise time:

PCM	max. pulse rise time V/ $\mu\text{sec}$ at $T_A < 40^\circ\text{C}$				
	450 VDC	630 VDC	800 VDC	900 VDC	1050 VDC
27.5	48	59	71	81	93
37.5	32	41	51	60	69
52.5	27	32	37	43	48

for pulses equal to the rated voltage

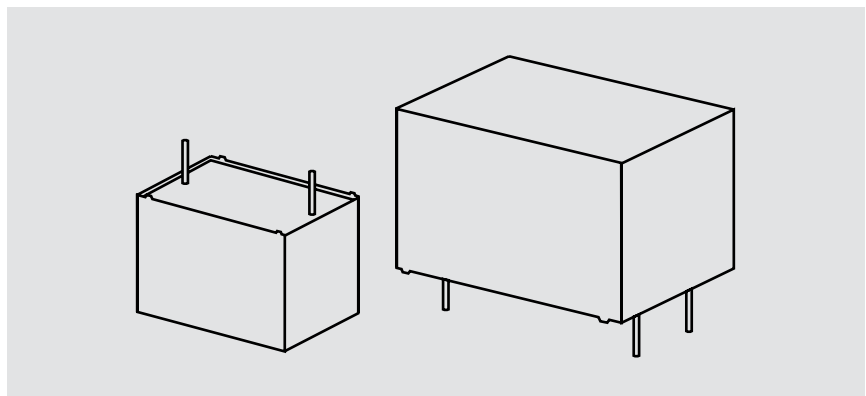

**Insulation resistance** at  $+20^\circ\text{C}$ :

$\geq 30\,000$  sec ( $M\Omega \times \mu\text{F}$ )

(mean value:  $100\,000$  sec)

Measuring voltage:  $100\text{ V}/1\text{ min}$ .

**Test voltage:**  $1.6 U_r$ , 2sec

**Dielectric absorption:** 0.05 %

**Specific dissipation:**

Box size WxHxL in mm	Specific dissipation in Watts per K above the ambient temperature
11 x 21 x 31.5	0.025
13 x 24 x 31.5	0.030
15 x 26 x 31.5	0.034
17 x 29 x 31.5	0.039
17 x 34.5 x 31.5	0.044
20 x 39.5 x 31.5	0.053
15 x 26 x 41.5	0.042
17 x 29 x 41.5	0.048
19 x 32 x 41.5	0.054
20 x 39.5 x 41.5	0.065
24 x 45.5 x 41.5	0.080
31 x 46 x 41.5	0.092
35 x 50 x 41.5	0.106
40 x 55 x 41.5	0.123
35 x 50 x 57	0.132
45 x 55 x 57	0.164
45 x 65 x 57	0.184

## Packing

Packing units at the end of the catalogue.

For further details and graphs please refer to Technical Information.



## Continuation

### General Data

Capacitance	W	H	L	PCM**	Pin	450 VDC (70° C) / 300 VDC (85° C)				Part number
						I <sub>s</sub> A	I <sub>rms</sub> (10 kHz)*		ESR (10 kHz)* mΩ	
							10 K	20 K		
2.2 μF	11	21	31.5	27.5	2/4	106	4.3	6.1	13.7	DCPSH042206B
3.3 "	13	24	31.5	27.5	2/4	158	5.3	7.5	10.6	DCPSH043306D
4.7 "	15	26	31.5	27.5	2/4	226	6.2	8.8	8.8	DCPSH044706F
6.8 "	17	29	31.5	27.5	2/4	326	7.4	10.5	7.1	DCPSH046806G
10 μF	19	32	41.5	37.5	2/4	320	9.6	13.6	5.9	DCPSH051007F
15 "	20	39.5	41.5	37.5	2/4	480	11.8	16.7	4.7	DCPSH051507G
20 "	24	45.5	41.5	37.5	2/4	640	13.9	19.7	4.1	DCPSH052007H
25 "	31	46	41.5	37.5	2/4	800	15.5	21.9	3.8	DCPSH052507I
30 "	31	46	41.5	37.5	2/4	960	16.3	23.0	3.5	DCPSH053007I
35 "	35	50	41.5	37.5	2/4	1120	18.3	25.8	3.2	DCPSH053507J
40 "	40	55	41.5	37.5	2/4	1280	20.3	28.7	3.0	DCPSH054007K
	35	50	57	52.5	4	1080	21.0	29.7	3.0	DCPSH054009F
45 "	35	50	57	52.5	4	1215	21.7	30.7	2.8	DCPSH054509F
50 "	35	50	57	52.5	4	1350	22.4	31.7	2.6	DCPSH055009F
55 "	45	55	57	52.5	4	1485	25.4	35.9	2.5	DCPSH055509H
60 "	45	55	57	52.5	4	1620	26.0	36.8	2.4	DCPSH056009H
65 "	45	55	57	52.5	4	1755	26.3	37.2	2.4	DCPSH056509H
70 "	45	65	57	52.5	4	1890	28.2	39.8	2.3	DCPSH057009J
75 "	45	65	57	52.5	4	2025	28.6	40.4	2.3	DCPSH057509J
80 "	45	65	57	52.5	4	2160	29.0	41.0	2.2	DCPSH058009J

Capacitance	W	H	L	PCM**	Pin	630 VDC (70° C) / 450 VDC (85° C)				Part number
						I <sub>s</sub> A	I <sub>rms</sub> (10 kHz)*		ESR (10 kHz)* mΩ	
							10 K	20 K		
1.5 μF	11	21	31.5	27.5	2/4	89	3.8	5.4	17.0	DCPSJ041506B
2.2 "	13	24	31.5	27.5	2/4	130	4.7	6.6	13.7	DCPSJ042206D
3.3 "	15	26	31.5	27.5	2/4	195	5.7	8.0	10.6	DCPSJ043306F
4.7 "	17	34.5	31.5	27.5	2/4	277	7.1	10.0	8.8	DCPSJ044706L
6.8 "	17	29	41.5	37.5	2/4	279	8.2	11.6	7.1	DCPSJ046807E
10 μF	20	39.5	41.5	37.5	2/4	410	10.5	14.8	5.9	DCPSJ051007G
15 "	31	46	41.5	37.5	2/4	615	14.0	19.8	4.7	DCPSJ051507I
20 "	35	50	41.5	37.5	2/4	820	16.0	22.6	4.1	DCPSJ052007J
25 "	40	55	41.5	37.5	2/4	1025	18.0	25.5	3.8	DCPSJ052507K
30 "	35	50	57	52.5	4	960	19.6	27.7	3.5	DCPSJ053009F
35 "	35	50	57	52.5	4	1120	20.4	28.8	3.1	DCPSJ053509F
40 "	45	55	57	52.5	4	1280	23.4	33.1	3.0	DCPSJ054009H
45 "	45	55	57	52.5	4	1440	25.5	36.1	2.8	DCPSJ054509H
50 "	45	65	57	52.5	4	1600	26.4	37.3	2.6	DCPSJ055009J
55 "	45	65	57	52.5	4	1760	26.9	38.0	2.5	DCPSJ055509J
60 "	45	65	57	52.5	4	1920	27.5	38.8	2.4	DCPSJ056009J

\* General guide.

\*\* PCM = Printed circuit module = pin spacing

Dims. in mm.

#### Part number completion:

Version code:	2-pin	= D2
	4-pin	= D4
Tolerance:	20 %	= M
	10 %	= K
	5 %	= J
Packing:	bulk	= S
Pin length:	6-2	= SD
Taped version see page 145.		

Rights reserved to amend design data without prior notification.

Continuation page 127

## Continuation

### General Data

Capacitance	W	H	L	PCM**	Pin	800 VDC (70° C) / 630 VDC (85° C)				Part number
						$I_s$ A	$I_{rms}$ (10 kHz)* A		ESR (10 kHz)* mΩ	
							10 K	20 K		
1.0 μF	11	21	31.5	27.5	2/4	71	3.3	4.6	23.1	DCPSL041006B_
1.5 "	13	24	31.5	27.5	2/4	107	4.2	5.9	17.0	DCPSL041506D_
2.2 "	15	26	31.5	27.5	2/4	156	5.0	7.0	13.7	DCPSL042206F_
3.3 "	17	29	31.5	27.5	2/4	234	6.1	8.5	10.6	DCPSL043306G_
4.7 "	19	32	41.5	37.5	2/4	240	7.8	11.0	8.8	DCPSL044707F_
6.8 "	20	39.5	41.5	37.5	2/4	347	9.5	13.5	7.1	DCPSL046807G_
10 μF	24	45.5	41.5	37.5	2/4	510	11.7	16.4	5.9	DCPSL051007H_
15 "	31	46	41.5	37.5	2/4	765	14.0	19.8	4.7	DCPSL051507I_
20 "	40	55	41.5	37.5	2/4	1020	17.2	24.3	4.1	DCPSL052007K_
	35	50	57	52.5	4	740	17.9	25.2	4.1	DCPSL052009F_
25 "	35	50	57	52.5	4	925	18.6	26.2	3.8	DCPSL052509F_
30 "	45	55	57	52.5	4	1110	21.8	30.8	3.5	DCPSL053009H_
35 "	45	65	57	52.5	4	1295	24.0	33.9	3.2	DCPSL053509J_
40 "	45	65	57	52.5	4	1480	24.8	35.0	3.0	DCPSL054009J_

Capacitance	W	H	L	PCM**	Pin	900 VDC (70° C) / 750 VDC (85° C)				Part number
						$I_s$ A	$I_{rms}$ (10 kHz)* A		ESR (10 kHz)* mΩ	
							10 K	20 K		
0.68 μF	11	21	31.5	27.5	2/4	55	2.8	3.9	32.8	DCPSN036806B_
1.0 μF	13	24	31.5	27.5	2/4	81	3.6	5.1	23.1	DCPSN041006D_
1.5 "	15	26	31.5	27.5	2/4	122	4.5	6.3	17.0	DCPSN041506F_
2.2 "	17	29	31.5	27.5	2/4	178	5.3	7.5	13.7	DCPSN042206G_
3.3 "	17	29	41.5	37.5	2/4	198	6.7	9.5	10.6	DCPSN043307E_
4.7 "	20	39.5	41.5	37.5	2/4	282	8.6	12.1	8.8	DCPSN044707G_
6.8 "	24	45.5	41.5	37.5	2/4	408	10.6	15.0	7.1	DCPSN046807H_
10 μF	31	46	41.5	37.5	2/4	600	12.5	17.7	5.9	DCPSN051007I_
15 "	40	55	41.5	37.5	2/4	900	16.2	22.9	4.7	DCPSN051507K_
20 "	35	50	57	52.5	4	860	17.9	25.3	4.1	DCPSN052009F_
25 "	45	55	57	52.5	4	1075	20.7	29.3	3.8	DCPSN052509H_

\* General guide

\*\* PCM = Printed circuit module = pin spacing

Dims. in mm.

Part number completion:	
Version code:	2-pin = D2 4-pin = D4
Tolerance:	20 % = M 10 % = K 5 % = J
Packing:	bulk = S
Pin length:	6-2 = SD
Taped version see page 145.	

Rights reserved to amend design data without prior notification.

Continuation page 128

## Continuation

### General Data

Capacitance	W	H	L	PCM**	Pin	1050 VDC (70° C) / 875 VDC (85° C)				Part number
						$I_s$ A	$I_{rms}$ (10 kHz)* A		ESR (10 kHz)* mΩ	
							10 K	20 K		
0.47 μF	11	21	31.5	27.5	2/4	44	2.4	3.4	44.0	DCPSO334706B_____
0.68 "	11	21	31.5	27.5	2/4	63	2.8	3.9	32.8	DCPSO336806B_____
1.0 μF	13	24	31.5	27.5	2/4	93	3.6	5.1	23.1	DCPSO341006D_____
1.5 "	17	29	31.5	27.5	2/4	140	4.8	6.8	17.0	DCPSO341506G_____
	15	26	41.5	37.5	2/4	104	5.0	7.0	17.0	DCPSO341507D_____
2.2 "	17	34.5	31.5	27.5	2/4	205	5.7	8.0	13.7	DCPSO342206L_____
	17	29	41.5	37.5	2/4	152	5.9	8.4	13.7	DCPSO342207E_____
3.3 "	20	39.5	31.5	27.5	2/4	307	7.1	10.0	10.6	DCPSO343306J_____
	19	32	41.5	37.5	2/4	228	7.1	10.1	10.6	DCPSO343307F_____
4.7 "	20	39.5	41.5	37.5	2/4	324	8.6	12.1	8.8	DCPSO344707G_____
6.8 "	31	46	41.5	37.5	2/4	469	11.4	16.0	7.1	DCPSO346807L_____
10 μF	35	50	41.5	37.5	2/4	690	13.4	19.0	5.9	DCPSO351007J_____
15 "	35	50	57	52.5	4	720	16.8	23.8	4.7	DCPSO351509F_____
20 "	45	55	57	52.5	4	960	19.9	28.2	4.1	DCPSO352009H_____

\* General guide

\*\* PCM = Printed circuit module = pin spacing

Dims. in mm.

#### 2-pin version

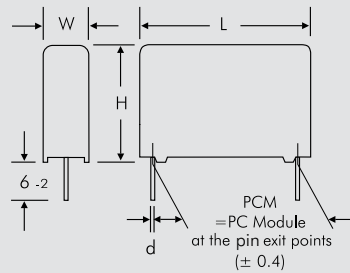

PCM	d
27.5	0.8
37.5	1

#### 4-pin version

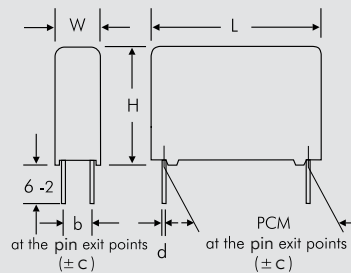

W	PCM	b	d	c
11	27.5	5	0.8	0.4
13	27.5	7.5	0.8	0.4
15	27.5	7.5	0.8	0.4
17	27.5	10	0.8	0.4
20	27.5	12.5	0.8	0.4
17	37.5	10	1	0.4
19	37.5	10	1	0.4
20	37.5	12.5	1	0.4
24	37.5	12.5	1	0.4
31	37.5	20	1	0.4
35	37.5	20	1	0.4
40	37.5	20	1	0.4
35	52.5	20	1.2	0.8
45	52.5	20	1.2	0.8

#### Part number completion:

Version code:	2-pin	= D2
	4-pin	= D4
Tolerance:	20 %	= M
	10 %	= K
	5 %	= J
Packing:	bulk	= S
Pin length:	6-2	= SD
Taped version see page 145.		

Rights reserved to amend design data without prior notification.

## Recommendation for Processing and Application of Through-Hole Capacitors

### Soldering Process

Internal temperature of the capacitor must be kept as follows:

Polyester: preheating:  $T_{max.} \leq 125^{\circ}C$   
soldering:  $T_{max.} \leq 135^{\circ}C$

Polypropylene: preheating:  $T_{max.} \leq 100^{\circ}C$   
soldering:  $T_{max.} \leq 110^{\circ}C$

#### Single wave soldering

Soldering bath temperature:  $T < 260^{\circ}C$   
Dwell time:  $t < 5 \text{ sec}$

#### Double wave soldering

Soldering bath temperature:  $T < 260^{\circ}C$   
Dwell time:  $\Sigma t < 5 \text{ sec}$

Due to different soldering processes and heat requirements the graphs are to be regarded as a recommendation only.

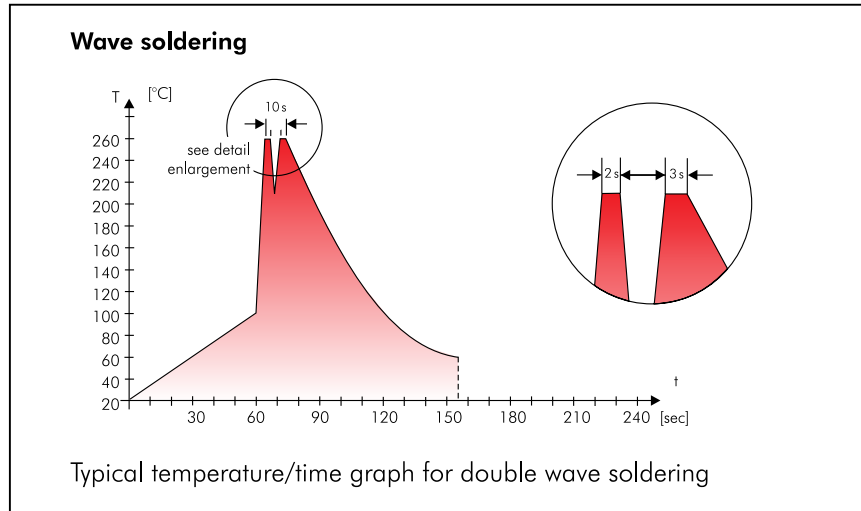

## WIMA Quality and Environmental Philosophy

### ISO 9001:2008 Certification

ISO 9001:2008 is an international basic standard of quality assurance systems for all branches of industry. The approval according to ISO 9001:2008 of our factories by the infaz (Institut für Auditierung und Zertifizierung) certifies that organisation, equipment and monitoring of quality assurance in our factories correspond to internationally recognized standards.

### WIMA WPCS

The WIMA Process Control System (WPCS) is a quality surveillance and optimization system developed by WIMA. WPCS is a major part of the quality-oriented WIMA production. Points of application during production process:

- incoming material inspection
- metallization
- film inspection
- schoopage
- pre-healing
- pin attachment
- cast resin preparation/encapsulation
- 100% final inspection
- Testing as per customer requirements

### WIMA Environmental Policy

All WIMA capacitors, irrespective of whether through-hole devices or SMD, are made of environmentally friendly materials. Neither during manufacture nor in the product itself any toxic substances are used, e.g.

- Lead
- PCB
- CFC
- Hydrocarbon chloride
- Chromium 6+
- PBB/PBDE
- Arsenic
- Cadmium
- Mercury
- etc.

We merely use pure, recyclable materials for packing our components, such as:

- carton
- cardboard
- adhesive tape made of paper
- polystyrene

We almost completely refrain from using packing materials such as:

- foamed polystyrene (Styropor®)
- adhesive tapes made of plastic
- metal clips

### RoHS Compliance

According to the RoHS Directive 2011/65/EU certain hazardous substances like e.g. lead, cadmium, mercury must not be used any longer in electronic equipment as of July 1st, 2006. For the sake of the environment WIMA has refrained from using such substances since years already.



WIMA Kondensatoren sind bleifrei konform RoHS 2011/65/EU

WIMA capacitors are lead free in accordance with RoHS 2011/65/EU

Tape for lead-free WIMA capacitors

### DIN EN ISO 14001:2004

WIMA's environmental management has been established in accordance with the guidelines of DIN EN ISO 14001:2004 to optimize the production processes with regard to energy and resources.

# Typical Dimensions for Taping Configuration

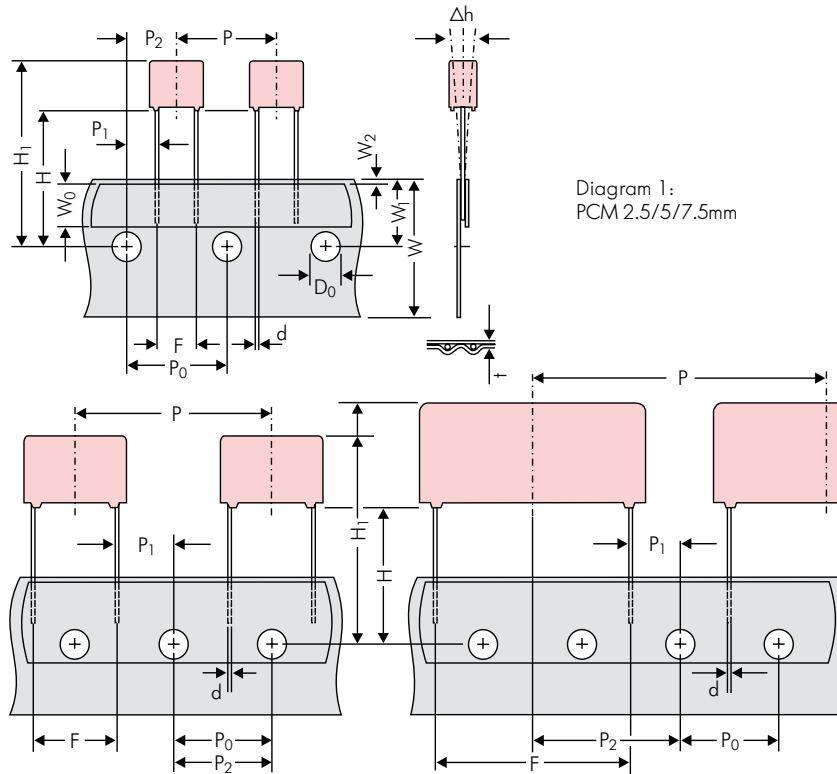

Diagram 1:  
PCM 2.5/5/7.5mm

Diagram 2: PCM 10/15 mm

Diagram 3: PCM 22.5 and 27.5\*mm

\*PCM 27.5 taping possible with two feed holes between components

Designation	Symbol	Dimensions for Radial Taping						
		PCM 2.5 taping	PCM 5 taping	PCM 7.5 taping	PCM 10 taping*	PCM 15 taping*	PCM 22.5 taping	PCM 27.5 taping
Carrier tape width	W	18.0 ±0.5	18.0 ±0.5	18.0 ±0.5	18.0 ±0.5	18.0 ±0.5	18.0 ±0.5	18.0 ±0.5
Hold-down tape width	W <sub>0</sub>	6.0 for hot-sealing adhesive tape	6.0 for hot-sealing adhesive tape	12.0 for hot-sealing adhesive tape	12.0 for hot-sealing adhesive tape	12.0 for hot-sealing adhesive tape	12.0 for hot-sealing adhesive tape	12.0 for hot-sealing adhesive tape
Hole position	W <sub>1</sub>	9.0 ±0.5	9.0 ±0.5	9.0 ±0.5	9.0 ±0.5	9.0 ±0.5	9.0 ±0.5	9.0 ±0.5
Hold-down tape position	W <sub>2</sub>	0.5 to 3.0 max.	0.5 to 3.0 max.	0.5 to 3.0 max.	0.5 to 3.0 max.	0.5 to 3.0 max.	0.5 to 3.0 max.	0.5 to 3.0 max.
Feed hole diameter	D <sub>0</sub>	4.0 ±0.2	4.0 ±0.2	4.0 ±0.2	4.0 ±0.2	4.0 ±0.2	4.0 ±0.2	4.0 ±0.2
Pitch of component	P	12.7 ±1.0	12.7 ±1.0	12.7 ±1.0	25.4 ±1.0	25.4 ±1.0	38.1 ±1.5	38.1 ±1.5 or 50.8 ±1.5
Feed hole pitch	P <sub>0</sub>	12.7 ±0.3 cumulative pitch error max. 1.0 mm/20 pitch	12.7 ±0.3 cumulative pitch error max. 1.0 mm/20 pitch	12.7 ±0.3 cumulative pitch error max. 1.0 mm/20 pitch	12.7 ±0.3 cumulative pitch error max. 1.0 mm/20 pitch	12.7 ±0.3 cumulative pitch error max. 1.0 mm/20 pitch	12.7 ±0.3 cumulative pitch error max. 1.0 mm/20 pitch	12.7 ±0.3 cumulative pitch error max. 1.0 mm/20 pitch
Feed hole centre to pin	P <sub>1</sub>	5.1 ±0.5	3.85 ±0.7	2.6 ±0.7	7.7 ±0.7	5.2 ±0.7	7.8 ±0.7	5.3 ±0.7
Hole centre to component centre	P <sub>2</sub>	6.35 ±1.3	6.35 ±1.3	6.35 ±1.3	12.7 ±1.3	12.7 ±1.3	19.05 ±1.3	19.05 ±1.3
Feed hole centre to bottom edge of the component	H	16.5 ±0.3 18.5 ±0.5	16.5 ±0.3 18.5 ±0.5	16.5 ±0.5 18.5 ±0.5	16.5 ±0.5 18.5 ±0.5	16.5 ±0.5 18.5 ±0.5	16.5 ±0.5 18.5 ±0.5	16.5 ±0.5 18.5 ±0.5
Feed hole centre to top edge of the component	H <sub>1</sub>	H+H <sub>component</sub> < H <sub>1</sub> 32.25 max.	H+H <sub>component</sub> < H <sub>1</sub> 32.25 max.	H+H <sub>component</sub> < H <sub>1</sub> 24.5 to 31.5	H+H <sub>component</sub> < H <sub>1</sub> 25.0 to 31.5	H+H <sub>component</sub> < H <sub>1</sub> 26.0 to 37.0	H+H <sub>component</sub> < H <sub>1</sub> 30.0 to 43.0	H+H <sub>component</sub> < H <sub>1</sub> 35.0 to 45.0
Pin spacing at upper edge of carrier tape	F	2.5 ±0.5	5.0 <sup>+0.8</sup> <sub>-0.2</sub>	7.5 ±0.8	10.0 ±0.8	15 ±0.8	22.5 ±0.8	27.5 ±0.8
Pin diameter	d	0.4 ±0.05	0.5 ±0.05	0.5 ±0.05 or 0.6 <sup>+0.06</sup> <sub>-0.05</sub>	0.5 ±0.05 or 0.6 <sup>+0.06</sup> <sub>-0.05</sub>	0.8 <sup>+0.08</sup> <sub>-0.05</sub>	0.8 <sup>+0.08</sup> <sub>-0.05</sub>	0.8 <sup>+0.08</sup> <sub>-0.05</sub>
Component alignment	Δh	± 2.0 max.	± 2.0 max.	± 3.0 max.	± 3.0 max.	± 3.0 max.	± 3.0 max.	± 3.0 max.
Total tape thickness	t	0.7 ±0.2	0.7 ±0.2	0.7 ±0.2	0.7 ±0.2	0.7 ±0.2	0.7 ±0.2	0.7 ±0.2
Package (see also page 146)	ROLL/AMMO			AMMO				
	REEL	φ 360 max. φ 30 ±1	B 52 ±2 58 ±2 } depending on comp. dimensions	REEL	φ 360 max. φ 30 ±1	52 ±2 58 ±2 or 66 ±2	REEL	φ 500 max. φ 25 ±1
Unit	see details page 147.							

Dims in mm.

\* Diameter of pins see General Data.

\* PCM 10 and PCM 15 can be crimped to PCM 7.5.

Position of components according to PCM 7.5 (sketch 11). P<sub>0</sub> = 12.7 or 15.0 is possible

Please clarify customer-specific deviations with the manufacturer.

## Types of Tape Packaging of Capacitors for Automatic Radial Insertion

### ■ ROLL Packaging

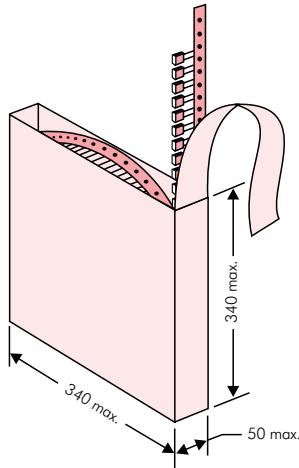

### ■ AMMO Packaging

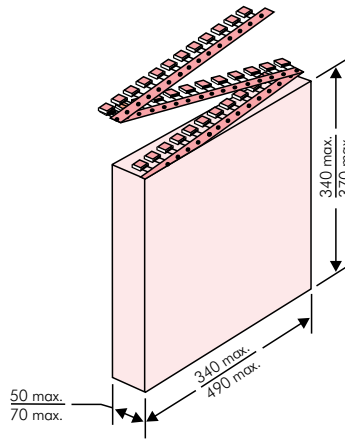

### ■ REEL Packaging

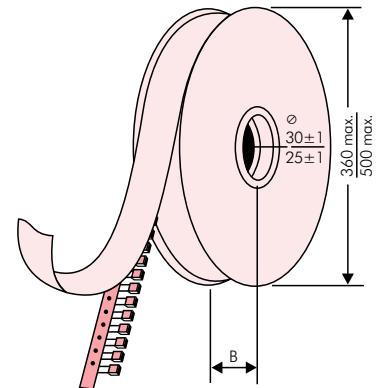

## BAR CODE (Labelling)

Labelling of package units in plain text and with alphanumerical Bar Code

Scanner decoding of

- WIMA supplier number
- Customer's P/O number
- Customer's part number
- WIMA confirmation number
- WIMA part number
- Lot number
- Date code
- Quantity

In addition part description of

- article
- capacitance value
- rated voltage
- dimensions
- capacitance tolerance
- packing

as well as gross weight and customer's name are indicated in plain text.

<b>WIMA</b> Best Capacitors Made In Germany		Werk Unna
Supplier-ID: 123456789	<b>RoHS</b> 2011/65/EU	Date Code: 08.10.10
Purchase Order No. (P/O): Bestellung xyz		Quantity: 5.000
Customer Part No.: KUNDETEILENUMMER		Customer No.: 0000100002
		Gross Weight [g]: 1870
WIMA Confirmation No.: 0001004053000100	WIMA Part No.: MKS2C034701C00K8SD	
Handling Unit: <b>MKS 2</b>	<b>QTY: 5.000</b>	<b>COO: DE</b>
	<b>MKS 2 0.47 µF 63 VDC 3.5x8.5x7.2 RM5</b>	
<b>1000067326</b>	Standard 10% Loss - Standard	Dichte 6-2
	Vorlage Debitor Inland	Week 03/2011

BARCODE „Code 39“

# Packing Quantities for Capacitors with Radial Pins in PCM 2.5 mm to 22.5 mm



PCM	Size				bulk	pcs. per packing unit								
						ROLL		REEL				AMMO		
	W	H	L	Codes		S	H16.5	H18.5	ø 360	ø 500	340 x 340	490 x 370		
					N	O	F	I	H	J	A	C	B	D
<b>2.5 mm</b>	2.5	7	4.6	<b>0B</b>	5000		2200	2500				2800		
	3	7.5	4.6	<b>0C</b>	5000		2000	2300				2300		
	3.8	8.5	4.6	<b>0D</b>	5000		1500	1800				1800		
	4.6	9	4.6	<b>0E</b>	5000		1200	1500				1500		
	5.5	10	4.6	<b>0F</b>	5000		900	1200				1200		
<b>5 mm</b>	2.5	6.5	7.2	<b>1A</b>	5000		2200	2500				2800		
	3	7.5	7.2	<b>1B</b>	5000		2000	2300				2300		
	3.5	8.5	7.2	<b>1C</b>	5000		1600	2000				2000		
	4.5	6	7.2	<b>1D</b>	6000		1300	1500				1500		
	4.5	9.5	7.2	<b>1E</b>	4000		1300	1500				1500		
	5	10	7.2	<b>1F</b>	3500		1100	1400				1400		
	5.5	7	7.2	<b>1G</b>	4000		1000	1200				1200		
	5.5	11.5	7.2	<b>1H</b>	2500		1000	1200				1200		
	6.5	8	7.2	<b>1I</b>	2500		800	1000				1000		
	7.2	8.5	7.2	<b>1J</b>	2500		700	1000				1000		
	7.2	13	7.2	<b>1K</b>	2000		700	950				1000		
	8.5	10	7.2	<b>1L</b>	2000		600	800				800		
	8.5	14	7.2	<b>1M</b>	1500		600	800				800		
11	16	7.2	<b>1N</b>	1000		500	600				400			
<b>7.5 mm</b>	2.5	7	10	<b>2A</b>	5000			2500	4400		2500			
	3	8.5	10	<b>2B</b>	5000			2200	4300		2300		4150	
	4	9	10	<b>2C</b>	4000			1700	3200		1700		3100	
	4.5	9.5	10.3	<b>2D</b>	3500			1500	2900		1400		2700	
	5	10.5	10.3	<b>2E</b>	3000			1300	2500		1300			
	5.7	12.5	10.3	<b>2F</b>	2000			1000	2200		1100			
	7.2	12.5	10.3	<b>2G</b>	1500			900	1800		1000			
<b>10 mm</b>	3	9	13	<b>3A</b>	3000			1100	2200				1900	
	4	8.5	13.5	<b>3A</b>	3000			900	1600				1450	
	4	9	13	<b>3C</b>	3000			900	1600				1450	
	4	9.5	13	<b>3D</b>	3000			900	1600				1400	
	5	10	13.5	<b>3B</b>	2000			700	1300				1200	
	5	11	13	<b>3F</b>	3000			700	1300				1200	
	6	12	13	<b>3G</b>	2400			550	1100				1000	
	6	12.5	13	<b>3H</b>	2400			550	1100				1000	
8	12	13	<b>3I</b>	2000			400	800				740		
<b>15 mm</b>	5	11	18	<b>4B</b>	2400			600	1200				1150	
	5	13	19	<b>4C</b>	1000			600	1200				1200	
	6	12.5	18	<b>4C</b>	2000			500	1000				1000	
	6	14	19	<b>4D</b>	1000			500	1000				1000	
	7	14	18	<b>4D</b>	1600			450	900				850	
	7	15	19	<b>4E</b>	1000			450	900				850	
	8	15	18	<b>4F</b>	1200			400	800				740	
	8	17	19	<b>4F</b>	500			400	800				740	
	9	14	18	<b>4H</b>	1200			350	700				650	
	9	16	18	<b>4J</b>	900			350	700				650	
	10	18	19	<b>4G</b>	500			300	650				590	
11	14	18	<b>4M</b>	1000			300	600				540		
<b>22.5 mm</b>	5	14	26.5	<b>5A</b>	1200				800				770	
	6	15	26.5	<b>5B</b>	1000				700				640	
	7	16.5	26.5	<b>5D</b>	760				600				550	
	8	20	28	<b>5H</b>	500				500				480	
	8.5	18.5	26.5	<b>5F</b>	500				480				450	
	10	22	28	<b>5I</b>	570*				420				380	
	10.5	19	26.5	<b>5G</b>	594*				400				360	
	10.5	20.5	26.5	<b>5H</b>	594*				400				360	
	11	21	26.5	<b>5I</b>	561*				380				350	
	12	24	28	<b>5J</b>	480*				350				310	

\* TPS (Tray-Packing-System). Plate versions may have different packing units.   Moulded versions. Rights reserved to amend design data without prior notification. Samples and pre-production needs on request.





## Packing Quantities for Capacitors with Radial Pins in PCM 27.5 mm to 52.5 mm

PCM	Size				bulk	pcs. per packing unit											
						ROLL		REEL				AMMO					
	W	H	L	Codes		S	N	O	ø 360		ø 500		340 x 340		490 x 370		
								H16.5	H18.5	H16.5	H18.5	H16.5	H18.5	H16.5	H18.5	H16.5	H18.5
								F	I	H	J	A	C	B	D		
<b>27.5 mm</b>	9	19	31.5	<b>6A</b>	567*	-	-	-	-	460/340*	-	-	420				
	11	21	31.5	<b>6B</b>	459*	-	-	-	-	380/280*	-	-	350				
	13	24	31.5	<b>6D</b>	378*	-	-	-	-	300	-	-	290				
	13	25	33	<b>6K</b>	405*	-	-	-	-	-	-	-	-				
	15	26	31.5	<b>6F</b>	324*	-	-	-	-	270	-	-	250				
	15	26	33	<b>6L</b>	324*	-	-	-	-	-	-	-	-				
	17	29	31.5	<b>6G</b>	198*	-	-	-	-	-	-	-	-				
	17	34.5	31.5	<b>6I</b>	198*	-	-	-	-	-	-	-	-				
	20	32	33	<b>6M</b>	162*	-	-	-	-	-	-	-	-				
	20	39.5	31.5	<b>6J</b>	162*	-	-	-	-	-	-	-	-				
<b>37.5 mm</b>	9	19	41.5	<b>7A</b>	441*	-	-	-	-	-	-	-	-				
	11	22	41.5	<b>7B</b>	357*	-	-	-	-	-	-	-	-				
	13	24	41.5	<b>7C</b>	294*	-	-	-	-	-	-	-	-				
	15	26	41.5	<b>7D</b>	252*	-	-	-	-	-	-	-	-				
	17	29	41.5	<b>7E</b>	154*	-	-	-	-	-	-	-	-				
	19	32	41.5	<b>7F</b>	140*	-	-	-	-	-	-	-	-				
	20	39.5	41.5	<b>7G</b>	126*	-	-	-	-	-	-	-	-				
	24	45.5	41.5	<b>7H</b>	112*	-	-	-	-	-	-	-	-				
	31	46	41.5	<b>7I</b>	84*	-	-	-	-	-	-	-	-				
	35	50	41.5	<b>7J</b>	35*	-	-	-	-	-	-	-	-				
	40	55	41.5	<b>7K</b>	28*	-	-	-	-	-	-	-	-				
<b>48.5 mm</b>	19	31	56	<b>8D</b>	120*	-	-	-	-	-	-	-	-				
	23	34	56	<b>8E</b>	80*	-	-	-	-	-	-	-	-				
	27	37.5	56	<b>8H</b>	84*	-	-	-	-	-	-	-	-				
	33	48	56	<b>8J</b>	25*	-	-	-	-	-	-	-	-				
	37	54	56	<b>8L</b>	25*	-	-	-	-	-	-	-	-				
<b>52.5 mm</b>	25	45	57	<b>9D</b>	70*	-	-	-	-	-	-	-	-				
	30	45	57	<b>9E</b>	60*	-	-	-	-	-	-	-	-				
	35	50	57	<b>9F</b>	25*	-	-	-	-	-	-	-	-				
	45	55	57	<b>9H</b>	20*	-	-	-	-	-	-	-	-				
	45	65	57	<b>9J</b>	20*	-	-	-	-	-	-	-	-				

\* for 2-inch transport pitches.

\* TPS (Tray-Packing-System). Plate versions may have different packing units. Samples and pre-production needs on request.

■ Moulded versions. Rights reserved to amend design data without prior notification.

Updated data on [www.wima.com](http://www.wima.com)



A WIMA part number consists of 18 digits and is composed as follows:

- Field 1 - 4: Type description
- Field 5 - 6: Rated voltage
- Field 7 - 10: Capacitance
- Field 11 - 12: Size and PCM
- Field 13 - 14: Version code (e.g. Snubber versions)
- Field 15: Capacitance tolerance
- Field 16: Packing
- Field 17 - 18: Pin length (untaped)

1	2	3	4	5	6	7	8	9	10	11	12	13	14	15	16	17	18
<b>M</b>	<b>K</b>	<b>S</b>	<b>2</b>	<b>C</b>	<b>0</b>	<b>2</b>	<b>1</b>	<b>0</b>	<b>0</b>	<b>1</b>	<b>A</b>	<b>0</b>	<b>0</b>	<b>M</b>	<b>S</b>	<b>S</b>	<b>D</b>
MKS 2				63 VDC		0.01 µF			2.5x6.5x7.2			-		20%	bulk	6 -2	

<p><b>Type description:</b></p> <p>SMD-PET = SMDT              SMD-PEN = SMDN              SMD-PPS = SMDI              FKP 02 = FKPO              MKS 02 = MKS0              FKS 2 = FKS2              FKP 2 = FKP2              FKS 3 = FKS3              FKP 3 = FKP 3              MKS 2 = MKS2              MKP 2 = MKP2              MKS 4 = MKS4              MKP 4C = MKPC              MKP 4 = MKP4              MKP 10 = MKP1              FKP 1 = FKP1              MKP-X2 = MKX2              MKP-X1 R = MKX1              MKP-Y2 = MKY2              MP 3-X2 = MPX2              MP 3-X1 = MPX1              MP 3-Y2 = MPY2              MP 3R-Y2 = MPRY              MKP 4F = MKPF              Snubber MKP = SNMP              Snubber FKP = SNFP              GTO MKP = GTOM              DC-LINK MKP 3 = DCP3              DC-LINK MKP 4 = DCP4              DC-LINK MKP 4S = DCP5              DC-LINK MKP 5 = DCP5              DC-LINK MKP 6 = DCP6              DC-LINK HC = DCHC              DC-LINK HY = DCHY</p>	<p><b>Rated voltage:</b></p> <p>50 VDC = B0              63 VDC = C0              100 VDC = D0              250 VDC = F0              400 VDC = G0              450 VDC = H0              520 VDC = H2              600 VDC = I0              630 VDC = J0              700 VDC = K0              800 VDC = L0              850 VDC = M0              900 VDC = N0              1000 VDC = O1              1100 VDC = P0              1200 VDC = Q0              1250 VDC = R0              1500 VDC = S0              1600 VDC = T0              2000 VDC = U0              2500 VDC = V0              3000 VDC = W0              4000 VDC = X0              6000 VDC = Y0              250 VAC = 0W              275 VAC = 1W              300 VAC = 2W              305 VAC = AW              350 VAC = BW              440 VAC = 4W              500 VAC = 5W              ...</p>	<p><b>Capacitance:</b></p> <p>22 pF = 0022              47 pF = 0047              100 pF = 0100              150 pF = 0150              220 pF = 0220              330 pF = 0330              470 pF = 0470              680 pF = 0680              1000 pF = 1100              1500 pF = 1150              2200 pF = 1220              3300 pF = 1330              4700 pF = 1470              6800 pF = 1680              0.01 µF = 2100              0.022 µF = 2220              0.047 µF = 2470              0.1 µF = 3100              0.22 µF = 3220              0.47 µF = 3470              1 µF = 4100              2.2 µF = 4220              4.7 µF = 4470              10 µF = 5100              22 µF = 5220              47 µF = 5470              100 µF = 6100              220 µF = 6220              1000 µF = 7100              1500 µF = 7150              ...</p>	<p><b>Size:</b></p> <p>4.8x3.3x3 Size 1812 = KA              4.8x3.3x4 Size 1812 = KB              5.7x5.1x3.5 Size 2220 = QA              5.7x5.1x4.5 Size 2220 = QB              7.2x6.1x3 Size 2824 = TA              7.2x6.1x5 Size 2824 = TB              10.2x7.6x5 Size 4030 = VA              12.7x10.2x6 Size 5040 = XA              15.3x13.7x7 Size 6054 = YA              2.5x7x4.6 PCM 2.5 = 0B              3x7.5x4.6 PCM 2.5 = 0C              2.5x6.5x7.2 PCM 5 = 1A              3x7.5x7.2 PCM 5 = 1B              2.5x7x10 PCM 7.5 = 2A              3x8.5x10 PCM 7.5 = 2B              3x9x13 PCM 10 = 3A              4x9x13 PCM 10 = 3C              5x11x18 PCM 15 = 4B              6x12.5x18 PCM 15 = 4C              5x14x26.5 PCM 22.5 = 5A              6x15x26.5 PCM 22.5 = 5B              9x19x31.5 PCM 27.5 = 6A              11x21x31.5 PCM 27.5 = 6B              9x19x41.5 PCM 37.5 = 7A              11x22x41.5 PCM 37.5 = 7B              19x31x56 PCM 48.5 = 8D              25x45x57 PCM 52.5 = 9D              ...</p> <p><b>Version code:</b></p> <p>Standard = 00              Version A1 = 1A              Version A1.1.1 = 1B              Version A2 = 2A              ...</p>	<p><b>Tolerance:</b></p> <p>±20% = M              ±10% = K              ±5% = J              ±2.5% = H              ±1% = E              ...</p> <p><b>Packing:</b></p> <p>AMMO H16.5 340x340 = A              AMMO H16.5 490x370 = B              AMMO H18.5 340x340 = C              AMMO H18.5 490x370 = D              REEL H16.5 360 = F              REEL H16.5 500 = H              REEL H18.5 360 = I              REEL H18.5 500 = J              ROLL H16.5 = N              ROLL H18.5 = O              BLISTER W12 180 = P              BLISTER W12 330 = Q              BLISTER W16 330 = R              BLISTER W24 330 = T              Bulk/TPS Standard = S              ...</p> <p><b>Pin length (untaped)</b></p> <p>3.5 ±0.5 = C9              6 -2 = SD              16 ±1 = P1              ...</p> <p><b>Pin length (taped)</b></p> <p>none = 00</p>
--	--	---	--	---

The data on this page is not complete and serves only to explain the part number system. Part number information is listed on the pages of the respective WIMA range.