



User's Manual

Version 1.0

Networking Appliance

PL-80260: Desktop Network Appliance with Intel[®] Atom[™] D510, 6GbE, SATA, CF, mini-PCI, PCI and bypass



www.win-ent.com

User's Manual

© Copyright WIN Enterprises. All Rights Reserved

Manual Edition 1.0, November 2010

This document contains proprietary information protected by copyright. All rights are reserved; no part of this manual may be reproduced, copied, translated or transmitted in any form or by any means without prior written permission of the manufacturer.

The content of this document is intended to be accurate and reliable; the original manufacturer assumes no responsibility for any inaccuracies that may be contained in this manual. The original manufacturer reserves the right to make improvements to the products described in this manual at any time without prior notice.

Trademarks

IBM, EGA, VGA, XT/AT, OS/2 and PS/2 are registered trademarks of International business Machine Corporation

Award is a trademark of Award Software International, Inc

Intel is a trademark of Intel

RTL is a trademark of Realtek

VIA is a trademark of VIA Technologies, Inc

Microsoft, Windows, Windows NT and MS-DOS are either trademarks or registered trademarks of Microsoft Corporation

All other product names mentioned herein are used for identification purpose only and may be trademarks and/or registered trademarks of their respective companies

Limitation of Liability

While reasonable efforts have been made to ensure the accuracy of this document, the manufacturer and distributor assume no liability resulting from errors or omissions in this document, or from the use of the information contained herein.

For more information on PL-80260 or other WIN Enterprises products, please visit our website

<http://www.win-ent.com> .

For technical supports or free catalog, please send your inquiry to

sales@win-ent.com .

Table of Contents

Chapter 1. General Information	4
1.1 Introduction.....	4
1.2 Specifications.....	5
1.3 Ordering Information.....	6
1.4 Packaging.....	6
1.5 Precautions.....	7
1.6 System Layout.....	8
1.7 Board Dimensions.....	9
Chapter 2. Connector/Jumper Configuration	10
2.1 Connector/Jumper Location and Definition.....	10
2.2 Connector and Jumper Setting.....	11
2.3 CompactFlash™ Card Socket Pin Define.....	17
Chapter 3. Optional GbE Module & Riser Card Setting	18
3.1 PM-104: Ethernet module with four 10/100 switch ports.....	18
3.2 PM-108: Ethernet module with eight 10/100 switch ports.....	20
Chapter 4. BIOS Setup	22
4.1 Quick Setup.....	22
4.2 Entering the CMOS Setup Program.....	23
4.3 Menu Options.....	24
4.4 Advanced Menu.....	25
4.5 PCIPnP Menu.....	38
4.6 Boot Menu.....	41
4.7 Security Menu.....	45
4.8 Chipset Menu.....	47
4.9 Exit Menu.....	52
Chapter 5. Utility & Driver Installation	54
5.1 Operation System Supporting.....	54
5.2 System Driver Installation.....	55
5.3 LAN Driver Installation.....	55
Appendix A: Programming the Watchdog Timer	56
Appendix B: LAN Bypass Function	59
Appendix C: System Resources	60
Appendix D: Cable Development Kit	64

Chapter 1. General Information

1.1 Introduction

The PL-80260 is a desktop platform designed for network service applications. Built with Intel Embedded IA components with warranty of longevity, the PL-80260 supports Intel® Atom™ D510 low-voltage processor with Intel Pineview chipset and ICH8-M I/O controller.

The platform supports a high bandwidth DDRII SODIMM slot with memory up to 2GB. In order to provide the best network performance and best utilization, powerful storage interfaces include one 3.5" SATA HDD and CompactFlash™. PL-80260 features up to six GbE Copper LAN with bypass function. The front panel also has two USB 2.0 ports, one RJ-45 console port and LED indicators that monitor power and storage device activities for local system management, maintenance and diagnostics. In addition, the PL-80260 supports one Mini PCI socket, one PCI slot, and is RoHS, FCC and CE compliant.

User's Manual

1.2 Specification

Processor System	CPU	Intel® Atom D510 Processor
	Chipset	Intel® Pineview + ICH8-M chipset
	BIOS	AMI® BIOS
Memory	Technology	Un-buffered and Non-ECC DDR2 667 MHz memory
	Capacity	Up to 2GB with one SO-DIMM socket
Expansion	Expansion Slots	one PCI expansion slot one mini-PCI socket one proprietary PCI-E x1 connector for expansion switch module (optional)
Ethernet	GbE Ethernet	six RJ45 GbE ports, Intel 82574L, PCI-E x1 (one pair bypass between LAN1 and LAN2) 4 or 8 switch 10/100 port (optional expansion module)
	LAN bypass	Two ports bypass (Optional)
Storage	SATA HDD	2.5" SATA HDD bay,
	Compact Flash Socket	one CompactFlash™ Type II
I/O	USB	two external USB 2.0
	Serial	one RJ45 Console port (COM1, RS232) one internal 5x2 pin header (COM2)
Power Supply	Watt	60W power supply, AC to DC 12V
Mechanical and Environment	Form Factor	Desktop
	LED	one Bypass LED (Green) one Power LED (Green) one HDD LED (Yellow) one Status LED (Green/Yellow via programmable GPIO)
	Dimensions, W x D x H	232mm (W) x 153.3mm (D) x 44mm (H); 9.1"W x 6"D x 1.7"H
	Operating Temperature	0 ~ 40°C (32 ~ 104°F)
	Storage Temperature	-20 ~ 75°C (-4 ~ 167°F)
	Humidity	10 ~ 85% relative humidity, non-operating, non-condensing

User's Manual

Weight	1pc/CTN, 4.5kgs, 59cm (W) x 43.2cm (D) x 16cm (H)
Certification	CE/FCC

1.3 Order Information

We offer various accessories for the PL-80260 appliance.

PL-8026A	Desktop Intel® D510 CPU, 6 GbE, CF, SATA, LCM, bypass
IP-90580	Expansion module with 4 Switch ports, Realtek RTL8306G
IP-90590	Expansion module with 8 Switch ports, Realtek RTL8309G
DK001	Cable development kit CB-CO5204-00 Cross over cable CB-EC5200-00 Ethernet cable CB-RJDB91-00 RJ45 Console cable CB-DB9200-01 Null modem cable CB-IVGA01-00 VGA cable CB-IPS200-00 KB/MS cable CB-IUSB01-00 USB cable

1.4 Packaging

Please make sure that the following items have been included in the package before installation.

1. PL-80260 Appliance
2. Quick Installation Guide (Optional)
3. Cables (Optional)
4. CD-ROM that contains the following folders:
 - i. Manual
 - ii. System Driver
 - iii. Ethernet Driver
 - iv. Utility Tools

If any of the above items is missing or damaged please contact your dealer or retailer from whom you purchased the PL-80260. Keep the box and carton if you plan to ship or store PL-80260 in near future. After you unpack the goods, inspect and make sure the packaging is intact. Do not plug the power adapter to the appliance of PL-80260 if you find it appears damaged.

Note: Keep the PL-80260 in the original packaging until you start installation.

1.5 Precautions

Please make sure you properly ground yourself before handling the PL-80260 appliance or system components. Electrostatic discharge can be easily damage the PL-80260 appliance.

Do not remove the anti-static packing until you are ready to install the PL-80260 appliance.

Ground yourself before removing any system component from its protective anti-static packaging. To ground yourself grasp the expansion slot covers or other unpainted parts of the computer chassis.

Avoid touching the components within the unit.

1.6 System Layout



PL-8C280 Front View



PL-8C280 Back View

1.7 Board Dimensions

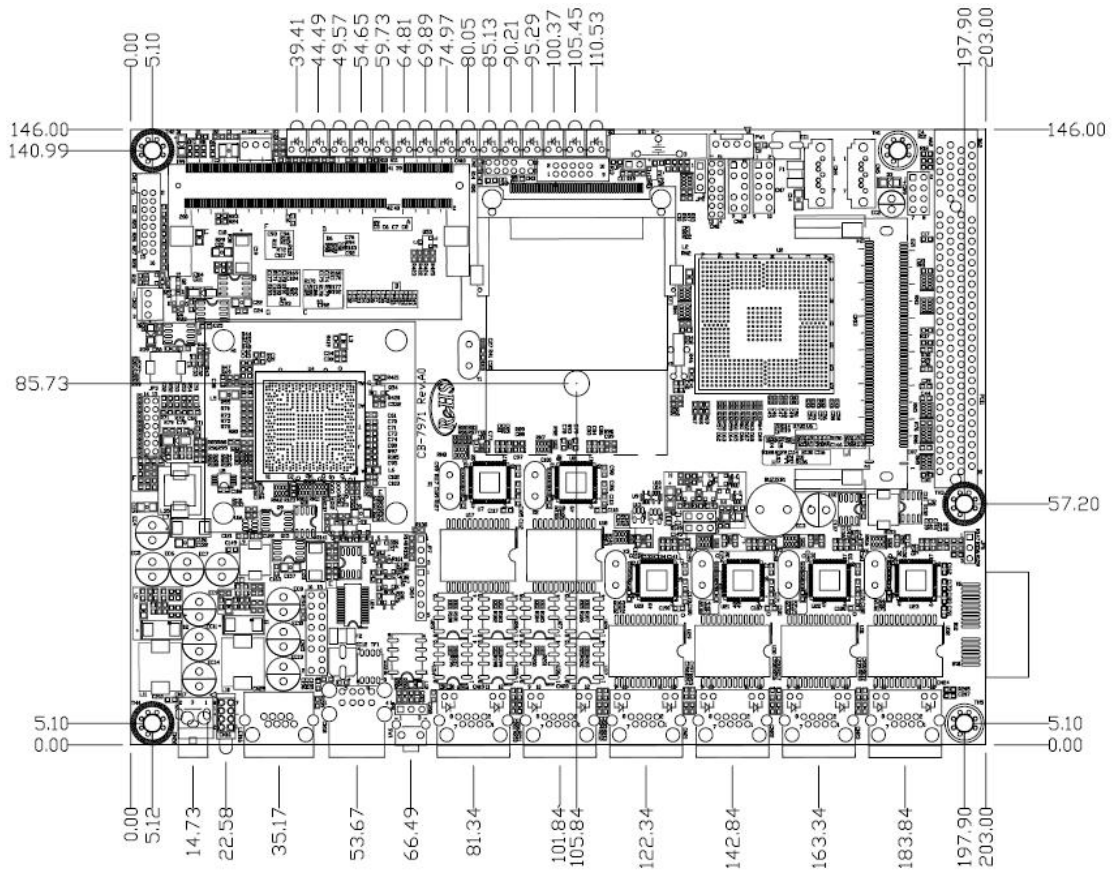

Chapter 2. Connector/Jumper Configuration

2.1 Connector/Jumper Location and Definition

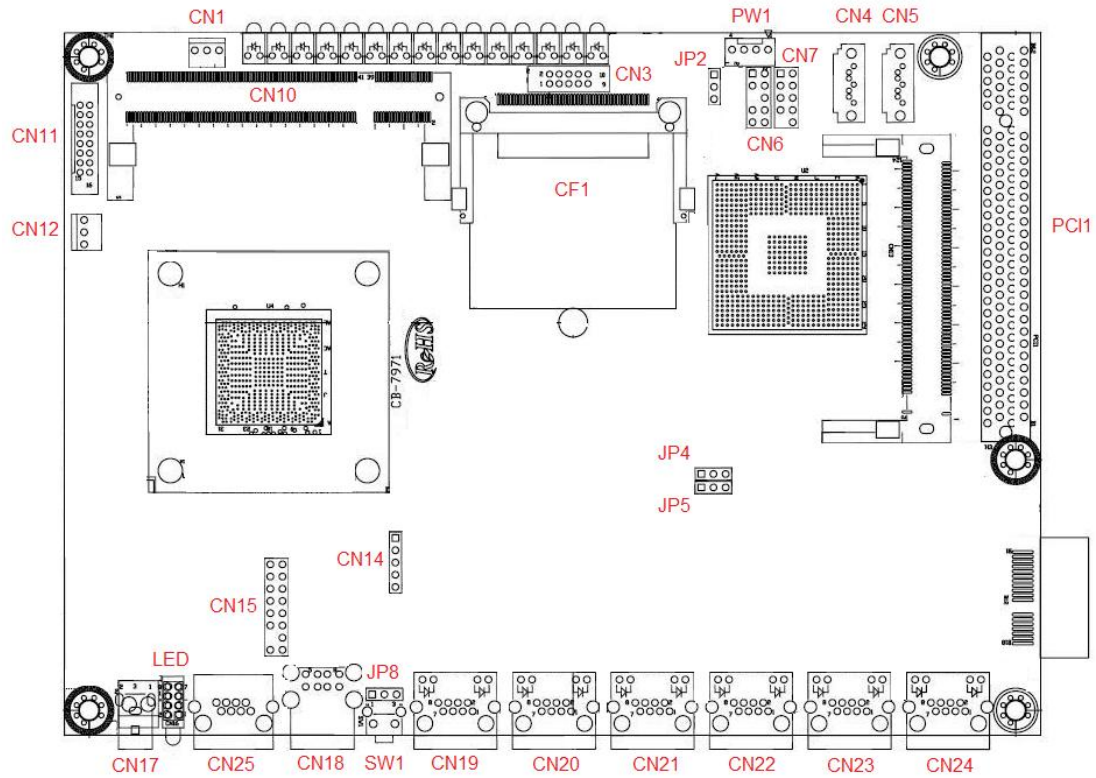

User's Manual

MB-80120 Connectors and Jumpers:

Connector	Define	Connector	Define
CN1	FAN Connector	CN3	COM2 Pin Header
CN4	SATA Connector	CN5	SATA Connector
CN6	PS2 KB/ MS Pin Header	CN7	USB Pin Header
CN10	DDR2 SLOT	CN11	VGA PORT
CN14	LCM KEY Pin Header	CN12	FAN Connector
CN17	POWER Pin Header	CN15	LCM Pin Header
CN19	LAN CONNECTOR	CN18	USB CONNECTOR
CN21	LAN CONNECTOR	CN20	LAN CONNECTOR
CN23	LAN CONNECTOR	CN22	LAN CONNECTOR
CN25	COM1 CONNECTOR	CN24	LAN CONNECTOR
PW1	HDD POWER	PCI1	PCI SLOT
SW1	RESET/GPI BUTTON	JP2	CLEAR CMOS
JP4	SELECT WATCHDOG/BYPASS	CF1	CF SLOT
JP8	SELECT RESET/GPI	JP5	SELECT BYPASS

2.2 Connector and Jumper Settings

CN1/CN12: CPU/System FAN

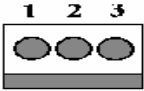
	
Pin	Define
1	Ground
2	+12V
3	Speed Detect

CN3: COM2 pin header

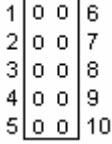
			
Pin	Define	Pin	Define
1	DCD#	6	DSR#
2	RXD#	7	RTS#
3	TXD#	8	CTS#
4	DTR#	9	RI#2
5	Ground	10	NC

CN4/CN5: SATA Connector

	Pin	Signal
	1	Ground
	2	TXP
	3	TXN
	4	Ground
	5	RXN
	6	RXP
	7	Ground

CN6: PS/2 KB/MS Pin Header

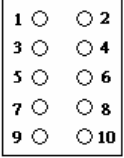
			
Pin	Define	Pin	Define
1	KCLK	2	MCLK
3	KDAT	4	MDAT
5	N/A	6	N/A
7	PS2_GND	8	PS2_GND
9	PS2_VCC	10	PS2_VCC

CN7: USB Pin Header

Pin	Define	Pin	Define
1	+5V	2	+5V
3	USB1N	4	USB2N-
5	USB1P	6	USB2P
7	Ground	8	Ground
9	N/A	10	Ground

CN18/CN20 : +12V Power Connector(8Pin)

Pin	Define	Pin	Define
1	Ground	5	+12V
2	Ground	6	+12V
3	Ground	7	+12V
4	Ground	8	+12V

CN11: VGA pin header

Pin	Define	Pin	Define
1	RED	2	GREEN
3	BLUE	4	Reserved
5	GND	6	RED RTN
7	GREEN RTN	8	BLUE RTN
9	+5V	10	GND
11	Reserved	12	SDA
13	HSYNC	14	VSYNC
15	SCL	16	Reserved

CN14: LCM KEYPAD Pin Header

Pin	Define
1	ACK#
2	BUSY
3	PE
4	SLCT
5	Ground

CN15: LCM Pin Header

Pin	Define	Pin	Define
1	+5V	2	Ground
3	AFD#	4	N/A
5	INIT#	6	SLIN#
7	PD1	8	PD0
9	PD3	10	PD2
11	PD5	12	PD4
13	PD7	14	PD6
15	BLN	16	BLP

CN17:POWER pin header

Pin	Define	Pin	Define
1	+12V	2	GND

User's Manual

CN19/CN20/CN21/CN22/CN23/CN24: LAN RJ-45 Connector

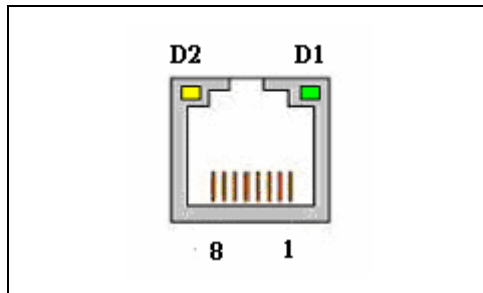

Pin	Define
1	TX+
2	TX-
3	RX+
4	Chassis Ground
5	Chassis Ground
6	RX-
7	Chassis Ground
8	Chassis Ground
D2: Speed indicated LED	
1 Gbps	GREEN
100 Mbps	YELLOW
D1 :Link/Activity LED	
Link	GREEN
Activity	BLINKING

CN18: USB Connector

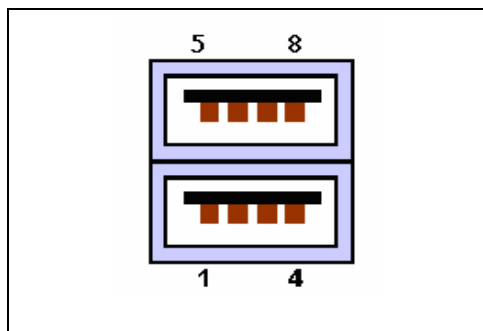

Pin	Define	Pin	Define
1	+5V	2	DATA0-
3	DATA0+	4	GND
5	+5V	6	DATA1-
7	DATA1+	8	GND

PW1: HDD POWER

Pin	Define
1	+12V
2	GND
3	GND
4	+5V

Jumper Settings

JP2: Clear CMOS

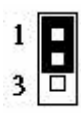
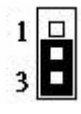
Pin	Setting
	1-2 Normal (Default)
	2-3 Clear CMOS

JP4: Select Watch Dog/Bypass

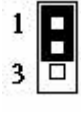
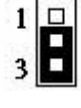
Pin	Setting
	1-2 Watch Dog
	2-3 Bypass

JP5: Select Bypass

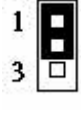
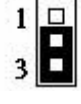
Pin	Setting
	1-2 Bypass Enable
	2-3 Bypass Disable

User's Manual

JP8: Select Reset/GPI

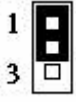
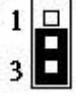
Pin		Setting
	1-2	GPI
	2-3	RESET

2.3 CompactFlash™ Card Socket Pin Define

CompactFlash™ card is a small removable mass storage device. It can provide complete PCMCIA-ATA functionality and compatibility plus True IDE functionality compatible with ATA/ATAPI-4.

CompactFlash™ storage products are solid state form factors, meaning they contain no moving parts. Thus, they provide users with much greater protection for their data than conventional magnetic disk devices.

Pin	Assignment	Pin	Assignment	Pin	Assignment	Pin	Assignment	Pin	Assignment
1	Ground	11	Ground	21	D00	31	D15	41	RESET
2	D03	12	Ground	22	D01	32	CS	42	ORDY
3	D04	13	VCC	23	D02	33	NC	43	DREG
4	D05	14	Ground	24	WP	34	IOR	44	DACK
5	D06	15	Ground	25	NC	35	IOW	45	LED
6	D07	16	Ground	26	NC	36	WE	46	BVD
7	CS	17	Ground	27	D11	37	RDY/BSY	47	D08
8	Ground	18	A02	28	D12	38	VCC	48	D09
9	Ground	19	A01	29	D13	39	SCSE	49	D10
10	Ground	20	A00	30	D14	40	NC	50	Ground

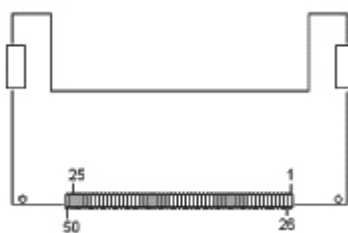

Chapter 3. Optional GbE Module & Riser Card Settings

The PL-80260 can offer various switch module combinations to match various applications and market demand.

3.1 IP-90580: Ethernet module with four 10/100 switch ports

IP-90580 is a four 10/100 switch ports module -- the golden edge fingers to be connected with proprietary PCI-E x1 connector of CB-7971 board.

3.1.1 Board Layout:

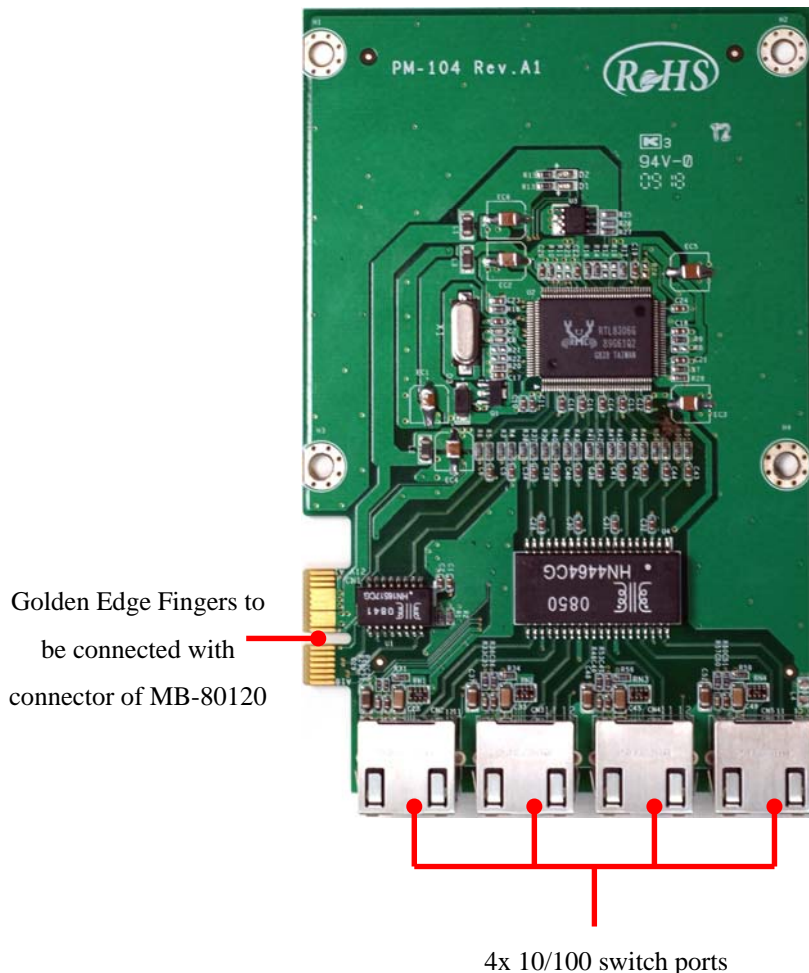

User's Manual

3.1.2 Board Dimensions:

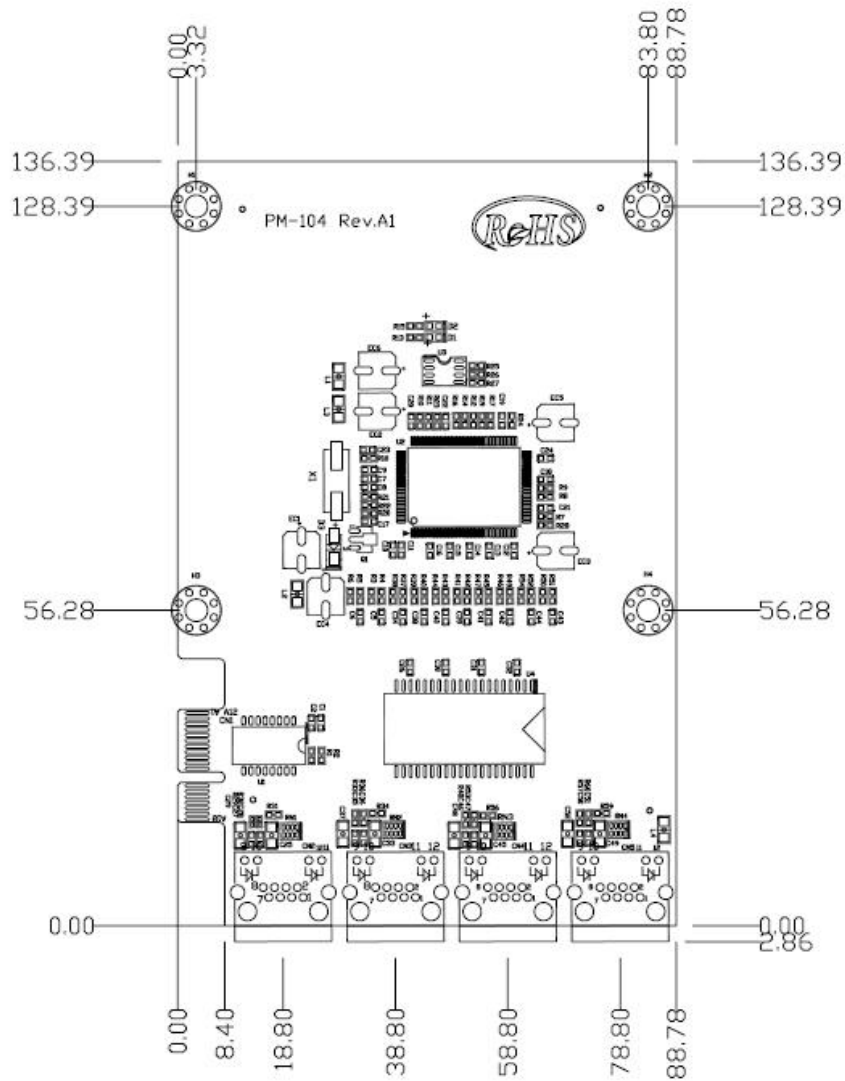

3.2 IP-90590: Ethernet module with eight 10/100 switch ports

IP-90590 is an eight 10/100 switch ports module. The golden edge fingers to be connected with proprietary PCI-E x1 connector of MB-80120 board.

3.2.1 Board Layout:

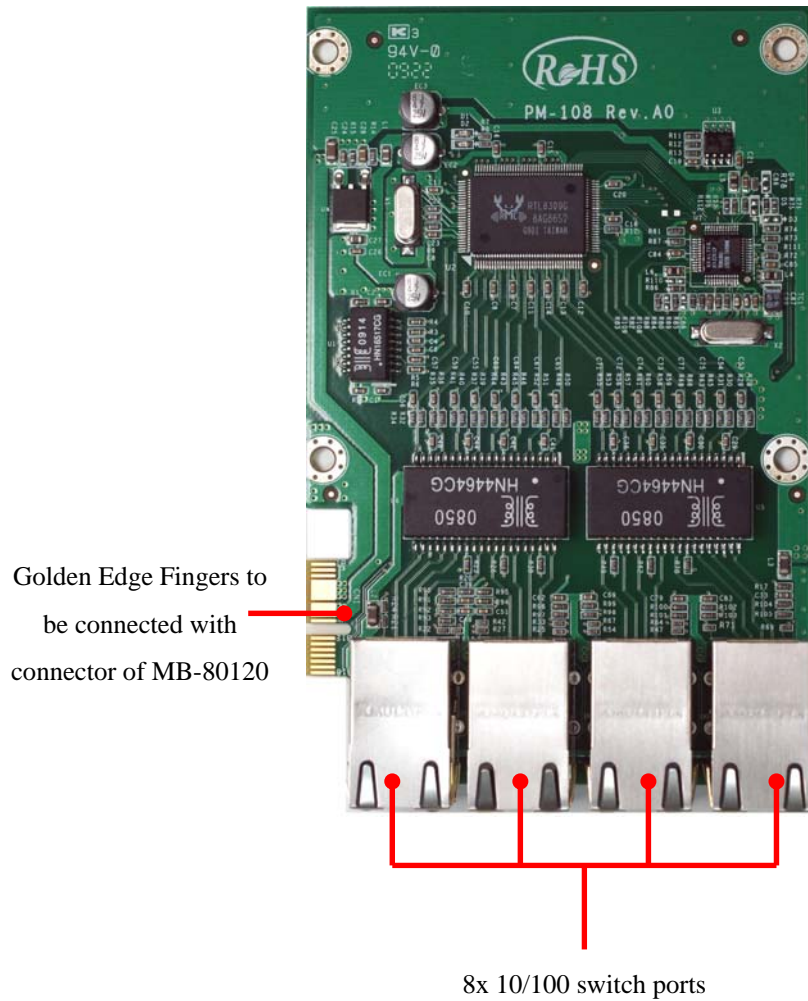

User's Manual

3.2.2 Board Dimensions:

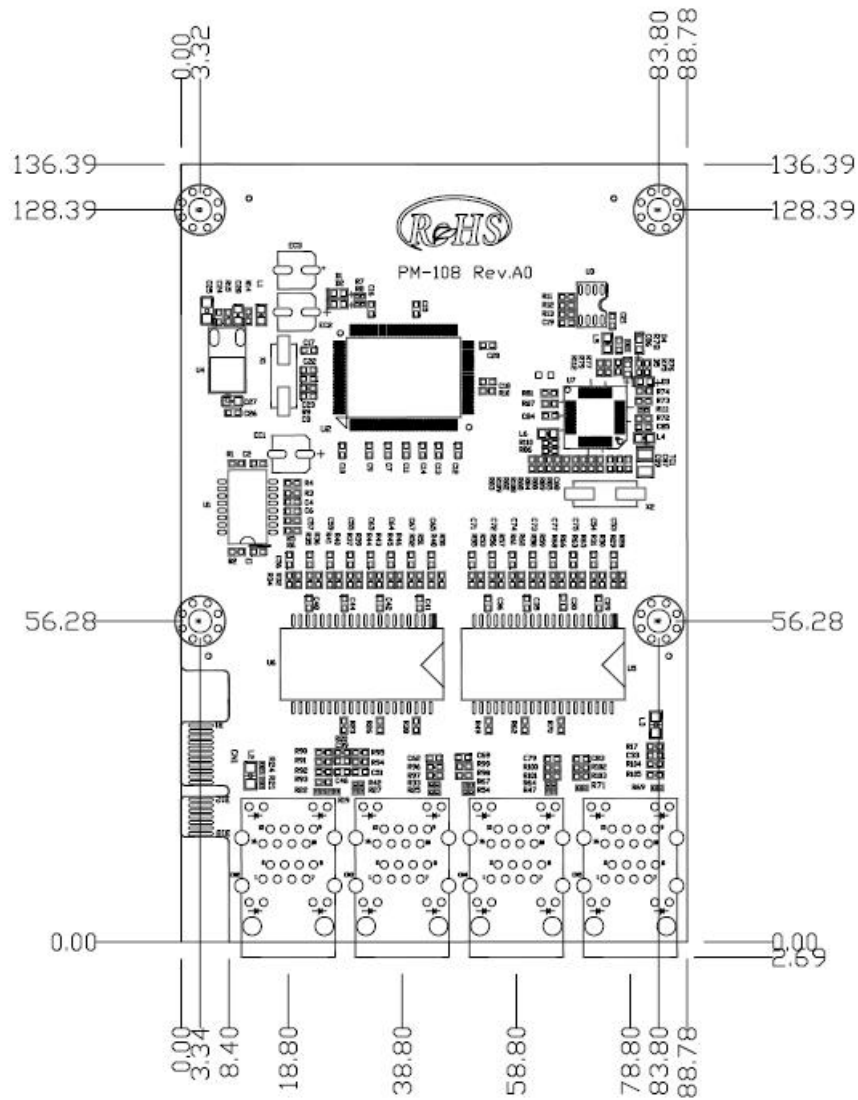

Chapter 4. BIOS Setup

The ROM chip of your PL-80120 board is configured with a customized Basic Input/Output System (BIOS) from AMI BIOS. The BIOS is a set of permanently recorded program routines that give the system its fundamental operational characteristics. It also tests the computer and determines how the computer reacts to instructions that are part of programs.

The BIOS is made up of code and programs that provide the device-level control for the major I/O devices in the system. It contains a set of routines (called POST, for Power-On Self Test) that check out the system when you turn it on. The BIOS also includes CMOS Setup program, so no disk-based setup program is required. CMOS RAM stores information for:

- Date and time
- Memory capacity of the appliance
- Type of display adapter installed
- Number and type of disk drives

The CMOS memory is maintained by battery installed on the PL-801200 board. By using the battery, all memory in CMOS can be retained when the system power switch is turned off or there is a power outage. The system BIOS also provides an easy way to reload the CMOS data when you replace the battery due to battery power loss.

4.1 Quick Setup

In most cases, you can quickly configure the system by choosing the following main menu options:

1. Choose "Exit" → "Load Optimal Defaults" from the main menu. This loads the setup default values from the BIOS Features Setup and Chipset Features Setup screens.
2. Choose "Main" & "Advanced" from the main menu. This option lets you configure the date and time, hard disk type, floppy disk drive type, primary display and more.
3. In the main menu, press F10 ("Save Changes and Exit") to save your changes and reboot the system.

4.2 Entering the CMOS Setup Program

Use the CMOS Setup program to modify the system parameters to reflect the options installed in your system and to customize your system. For example, you should run the Setup program after you:

- Received an error code at startup
- Install another disk drive
- Use your system after not having used it for a long time
- Find the original setup missing
- Replace the battery
- Change to a different type of CPU
- Run the AMI Flash program to update the system BIOS

Run the CMOS Setup program after you turn on the system. On-screen instructions explain how to use the program.

↓ **Enter the CMOS Setup program's main menu as follows:**

1. Turn on or reboot the system. After the BIOS performs a series of diagnostic checks, the following message appears:
"Press DEL to enter SETUP"
2. Press the key to enter CMOS Setup program. The main menu appears:

User's Manual

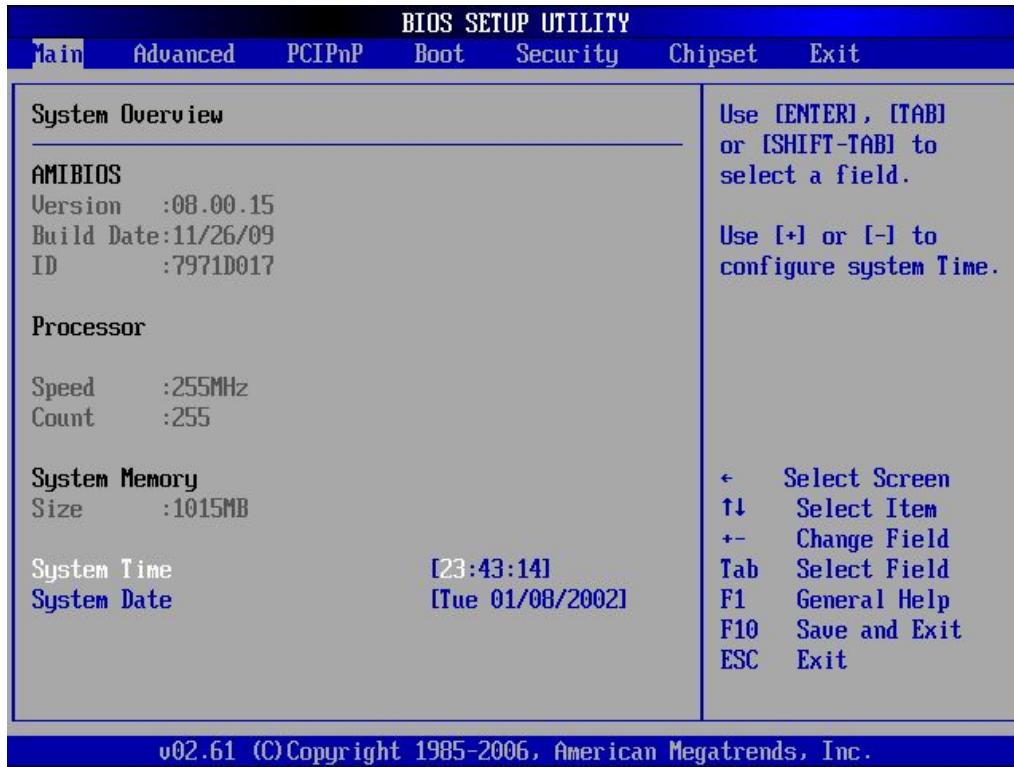

3. Choose a setup option with the arrow keys and press <Enter>. See the following sections for a brief description of each setup option.

AMIBIOS: Displays the auto-detected BIOS information.

Processor: Displays the auto-detected CPU specification.

System Memory: Displays the auto-detected system memory.

SystemTime: [hour:min:sec]:

This item allows you to set the system time.

System Date [Day mm/dd/yyyy]:

This item allows you to set the system date.

In the main menu, press F10 (“Save Changes and Exit”) to save your changes and reboot the system. Choosing “Discard Changes and Exit” ignores your changes and exits the program. Pressing <ESC> anywhere in the program returns you to the main menu.

4.3 Menu Options

The main menu options of the CMOS Setup program are described in the following and the following sections of this chapter.

Main: For changing the basic system configurations.

Advanced: For changing the advanced system settings.

PCIPnP: For changing the advanced PCI/PnP Settings.

Boot: For changing the system boot configurations.

Security: Use this menu to set User and Supervisor Passwords.

Chipset: For changing the chipset settings.

Exit: For selecting the exit options and loading default settings.

4.4 Advanced Menu

The Advanced menu items allow you to change the settings for the CPU and other system devices.

↓ **Use the Advanced Setup option as follows:**

1. Choose "Advanced" from the main menu. The following screen appears:

User's Manual

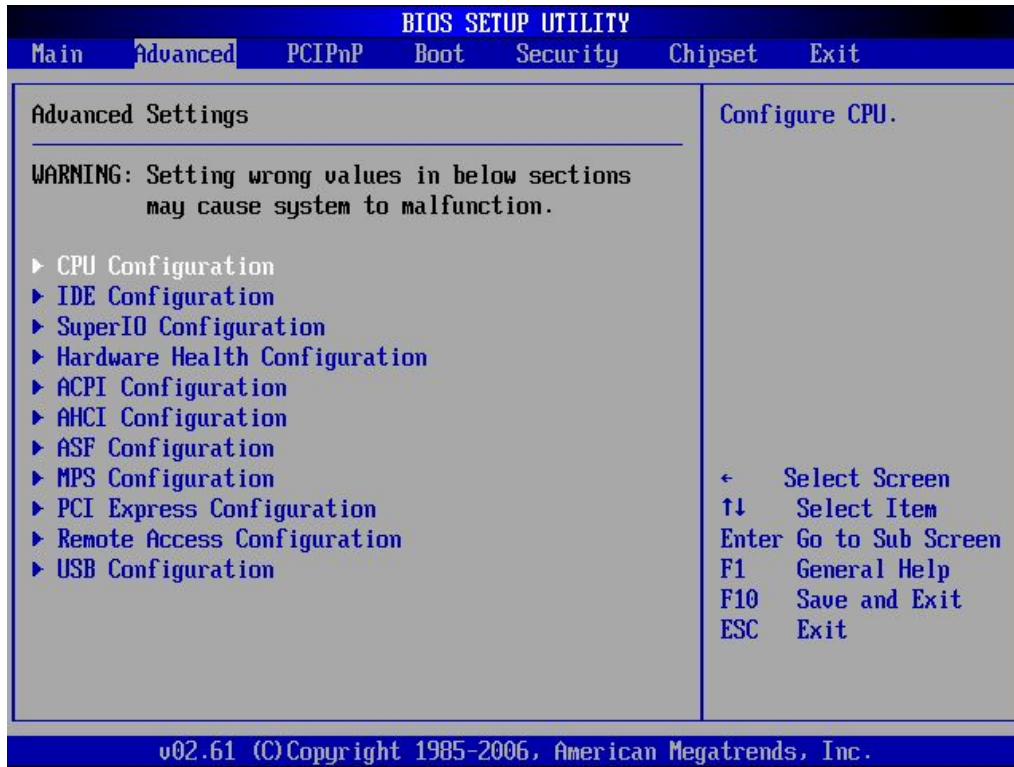

2. Use the arrow keys to move between fields. Modify the selected field using the PgUP/PgDN/+/- keys. Some fields let you enter numeric values directly.
3. After you have finished with the Advanced setup, press the <ESC> key to return to the main menu.

4.4.1 CPU Configuration

This sub menu shows the CPU-related information which is automatically detected by BIOS.

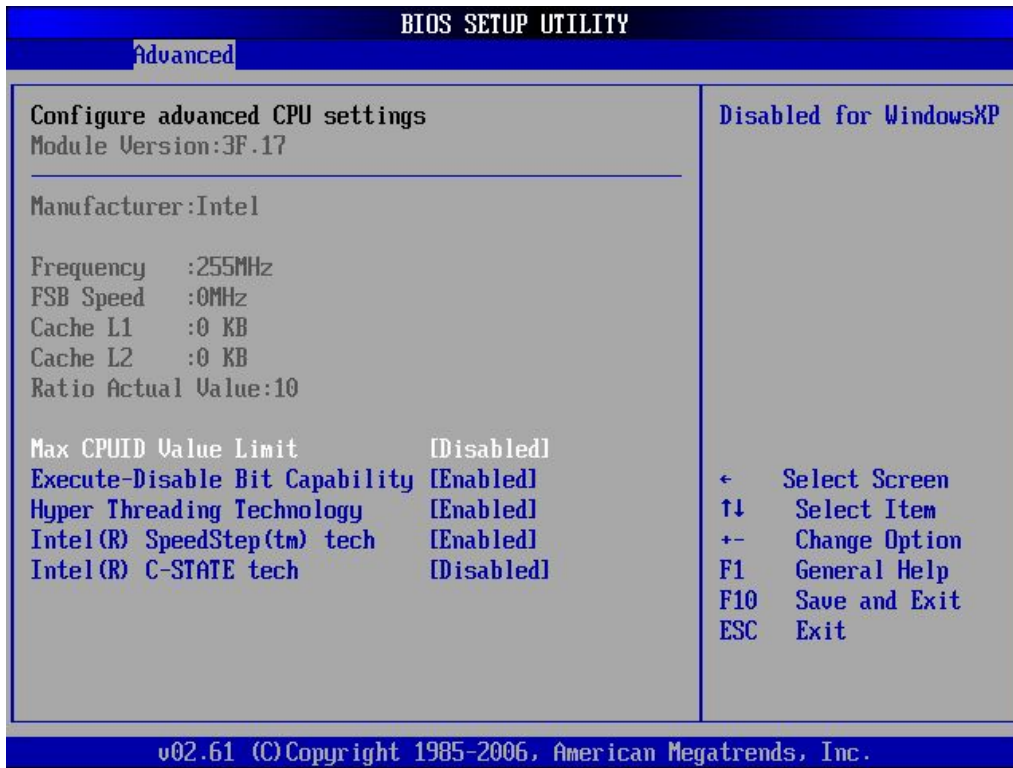

Max CPUID Value Limit: [Disabled]

Enable this item to boot legacy Operating System that cannot support CPU with extended CPUID function. This item should be disabled for Windows XP.

Execute-Disable Bit Capability: [Enabled]

Intel's Execute-Disable Bit is a hardware-based security feature that can reduce exposure to viruses and malicious-code attacks and prevent harmful software from executing and propagating on the server or network.

Hyper Threading Technology: [Enabled]

This item allows you to enable or disable the Intel® Hyper-Threading Technology.

Intel® SpeedStep® tech: [Enabled]

Intel® SpeedStep® is Intel's new power saving technology. Processor can switch between multiple frequency and voltage points to enable power savings.

Intel® C-STATE tech: [Disabled]

This item allows you to enable or disable the Intel® C-STATE tech.

4.4.2 IDE Configuration

This sub menu allows you to set or change the configurations for the IDE devices installed in the system.

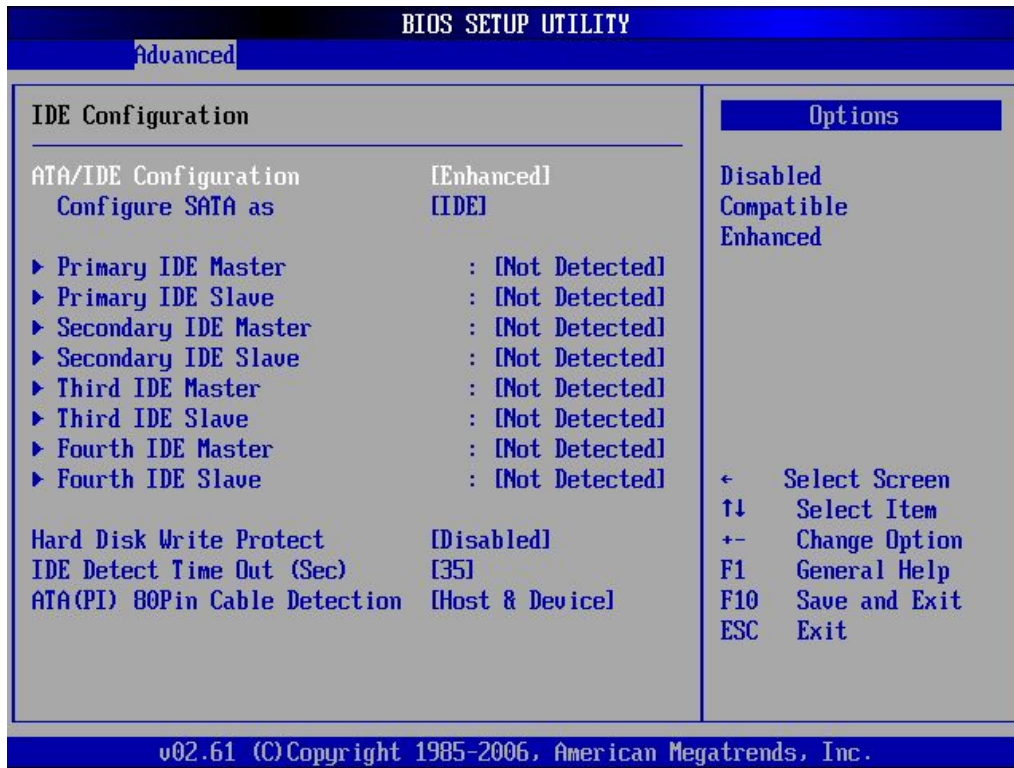

ATA/IDE Configuration: [Enhanced]

Configure SATA as: [IDE]

This item allows you to configure the ATA/IDE.

* Primary IDE Master and Primary IDE Slave

This information is auto-detected by BIOS and is not user-configurable. It will show "Not Detected" if no IDE device is installed in the system.

Secondary IDE Master and Secondary IDE Slave

This information is auto-detected by BIOS and is not user-configurable. It will show "Not Detected" if no IDE device is installed in the system.

Third/Fourth IDE Master and Third/Fourth IDE Slave

This information is auto-detected by BIOS and is not user-configurable. It will show "Not Detected" if no IDE device is installed in the system.

Hard Disk Write protect: [Disabled]

This menu allows you to enable or disable the hard disk write protect.

IDE Detect Time Out (Sec): [35]

Selects the time out value for detecting IDE devices.

ATA(PI) 80Pin Cable Detection: [Host & Device]

This menu allows you to configure the system for detecting 80-pin ATA(PI) cable.

* Primary IDE Master

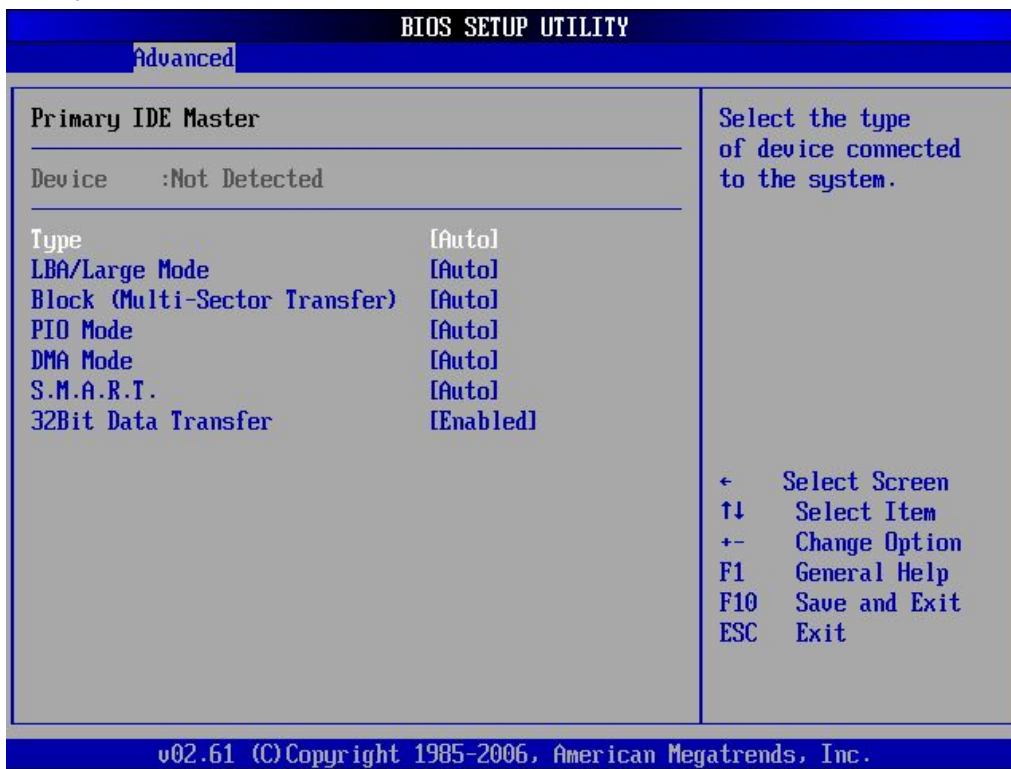

Type: [Auto]

Selects the type of IDE device. Setting to Auto allows automatic selection of the appropriate IDE device type.

LBA/Large Mode: [Auto]

Enables or disables the LBA/Large mode. Setting to Auto enables the LBA mode if the device supports this mode, and if the device was not previously formatted with LBA mode disabled.

Block (Multi-Sector Transfer): [Auto]

Enables or disables the Block (Multi-Sectors Transfer). When set to Auto, the data transfer from and to the device occurs multiple sectors at a time if the device supports

User's Manual

multi-sector transfer feature. When set to Disabled, the data transfer from and to the device occurs one sector at a time.

PIO Mode: [Auto]

Selects the PIO mode for the device.

DMA Mode: [Auto]

Selects the DMA mode for the device.

S.M.A.R.T.: [Auto]

S.M.A.R.T. (Self-Monitoring, Analysis, and Reporting Technology). It allows system to use the SMART protocol to monitor your hard disk status.

32Bit Data Transfer: [Enabled]

Enables or disables 32-bit data transfer. If the host controller does not support 32-bit data transfer, this menu must be set to [Disabled].

4.4.3 Super IO Configuration

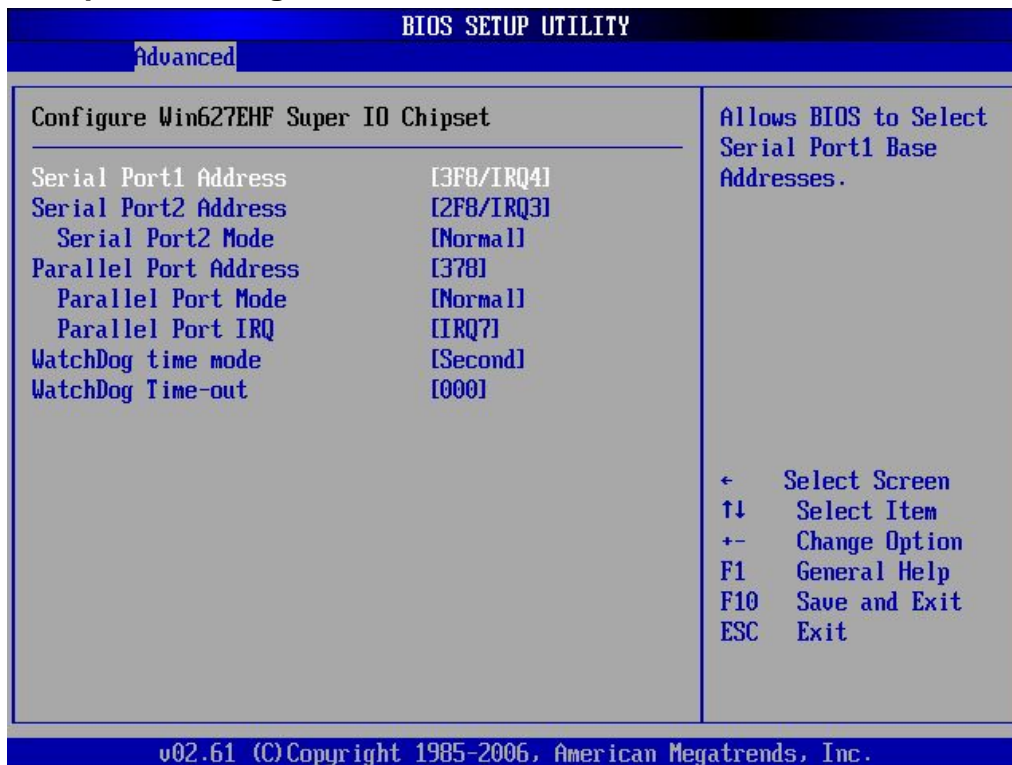

Serial Port1 Address: [3F8/IRQ4]

Selects the Serial Port1 base addresses and IRQ.

User's Manual

Serial Port2 Address: [2F8/IRQ3]

Selects the Serial Port2 base addresses and IRQ.

Serial Port2 Mode: [Normal]

Selects the Serial Port2 mode.

Parallel Port Address: [378]

Selects the Parallel Port base addresses.

Parallel Port Mode: [Normal]

Selects the Parallel Port mode.

Parallel Port IRQ: [IRQ7]

Selects the Parallel Port IRQ.

WatchDog time mode: [Second]

Selects the WatchDog time mode.

WatchDog Time-out: [000]

Set the time-out value.

4.4.4 Hardware Health Configuration

This screen shows you the CPU core voltage, System voltage, System temperature and CPU temperature.

BIOS SETUP UTILITY	
Advanced	
Hardware Health Configuration	
System Temperature	:33°C/91°F
CPU Temperature	:47°C/116°F
CPUFAN0 Speed	:6026 RPM
UCORE	:1.112 V
UCC3	:3.280 V
+12V	:12.004 V
UCCP	:1.048 V
DDR2	:1.824 V
UCC5	:4.992 V
UBAT	:3.056 V
SYSFAN Mode Setting	[Thermal Cruise Mod]
SYSFAN TargetTemp Value	[055]
CPUFAN0 Mode Setting	[Thermal Cruise Mod]
CPUFAN0 TargetTemp Value	[050]
Fan configuration mode setting	
←	Select Screen
↑↓	Select Item
+−	Change Option
F1	General Help
F10	Save and Exit
ESC	Exit

v02.61 (C) Copyright 1985-2006, American Megatrends, Inc.

4.4.5 ACPI Configuration

This sub menu is used to change the settings for the ACPI.

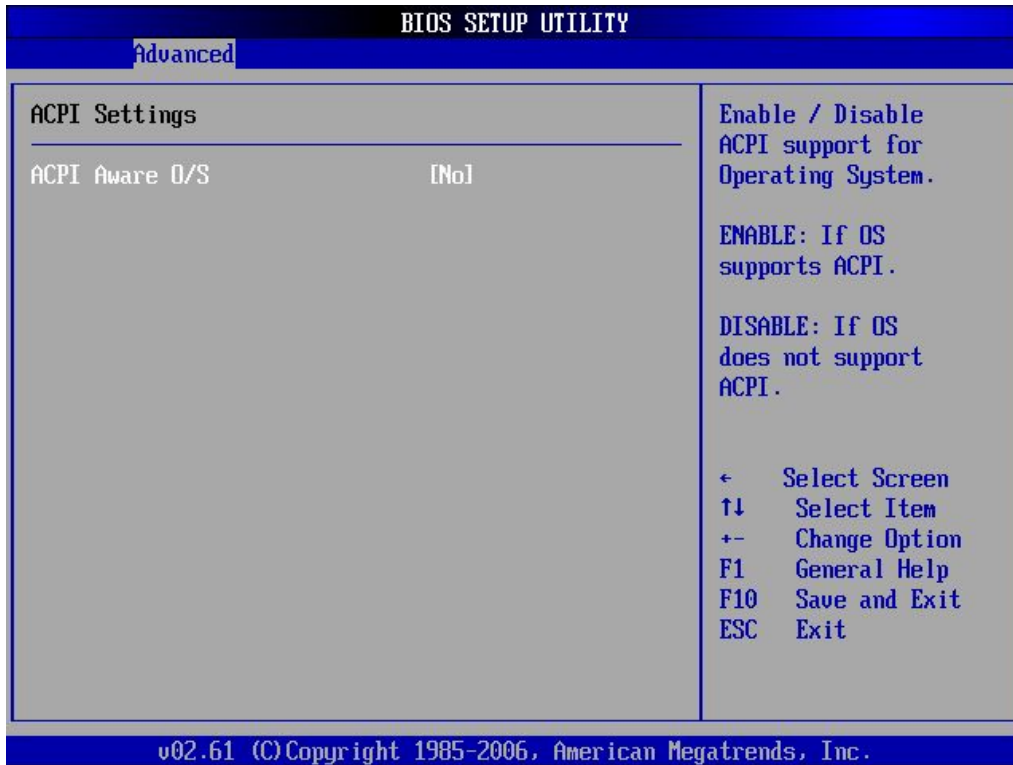

ACPI Aware O/S: Enables or disables ACPI support for Operating System.

4.4.6 AHCI Configuration

This sub menu is used to change the settings for the AHCI.

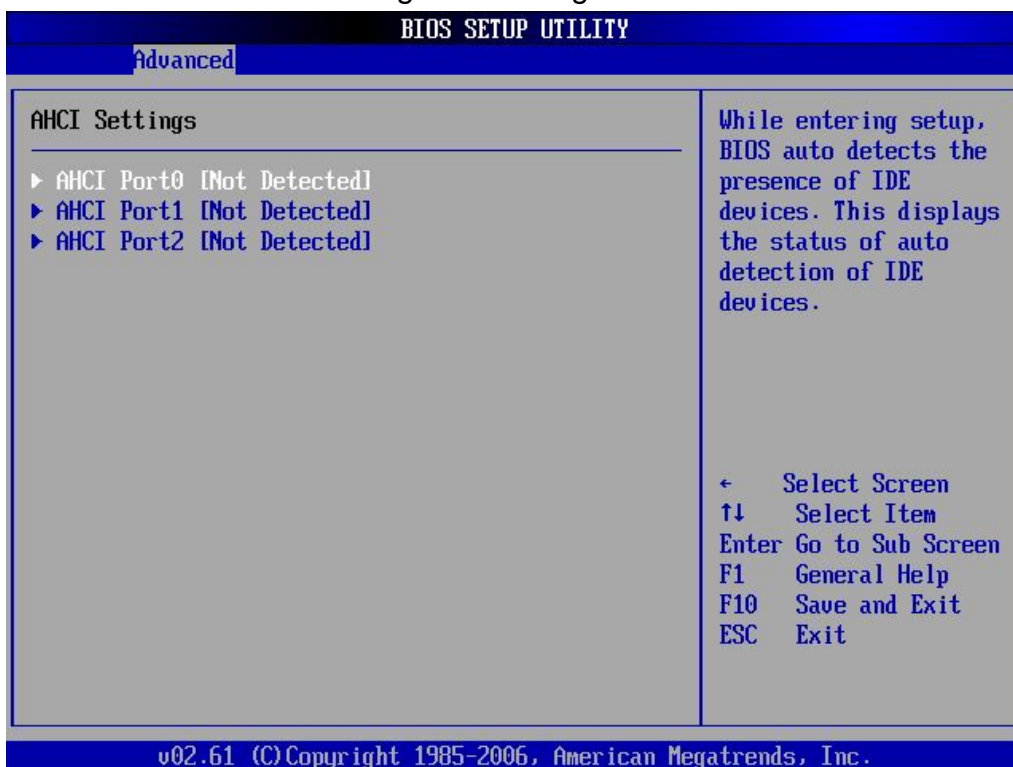

User's Manual

AHCI Port0/Port1/Port2: [Not Detected]

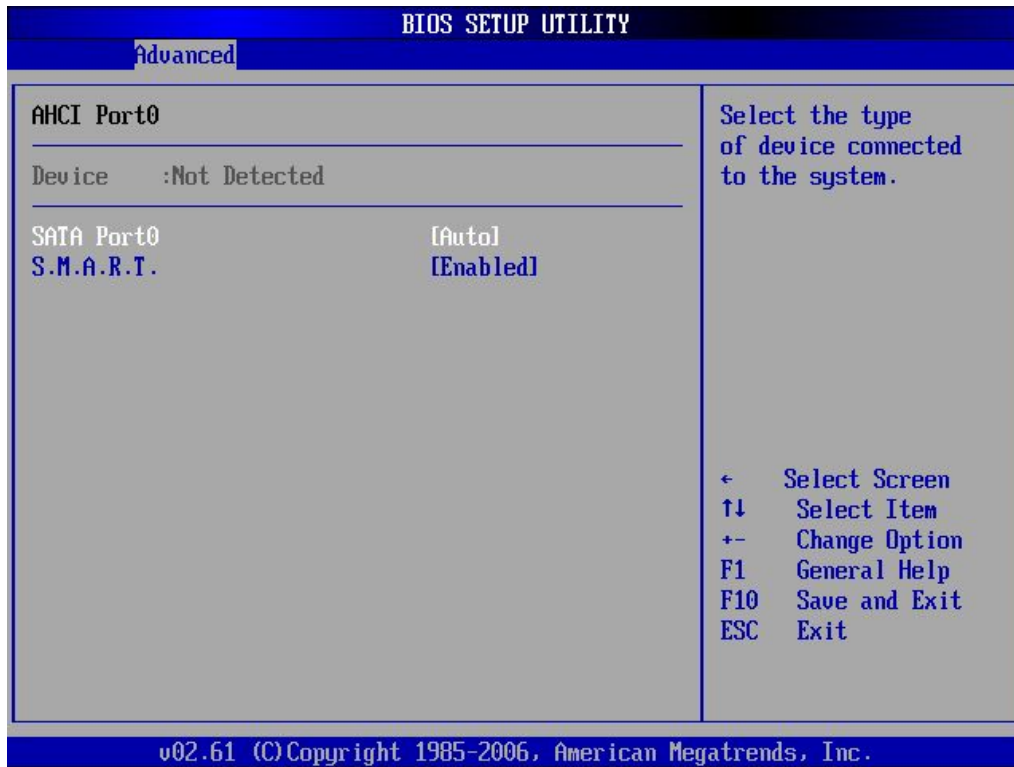

SATA Port0: [Auto]

Select the type of device connected to the system.

S.M.A.R.T.: [Enabled]

This item allows you to enable or disable S.M.A.R.T.

S.M.A.R.T. (Self-Monitoring, Analysis, and Reporting Technology). It allows system to use the SMART protocol to monitor your hard disk status.

User's Manual

4.4.7 ASF Configuration

This sub menu allows you to enable or disable the ASF support.

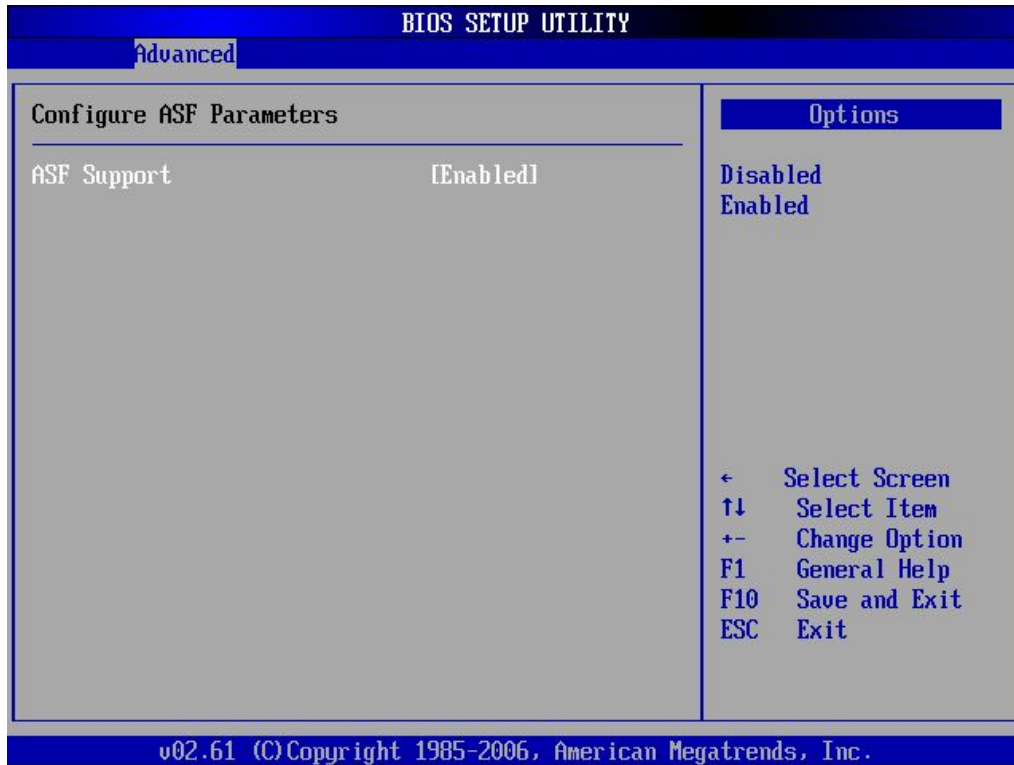

4.4.8 MPS Configuration

This sub menu allows you to select MPS Revision.

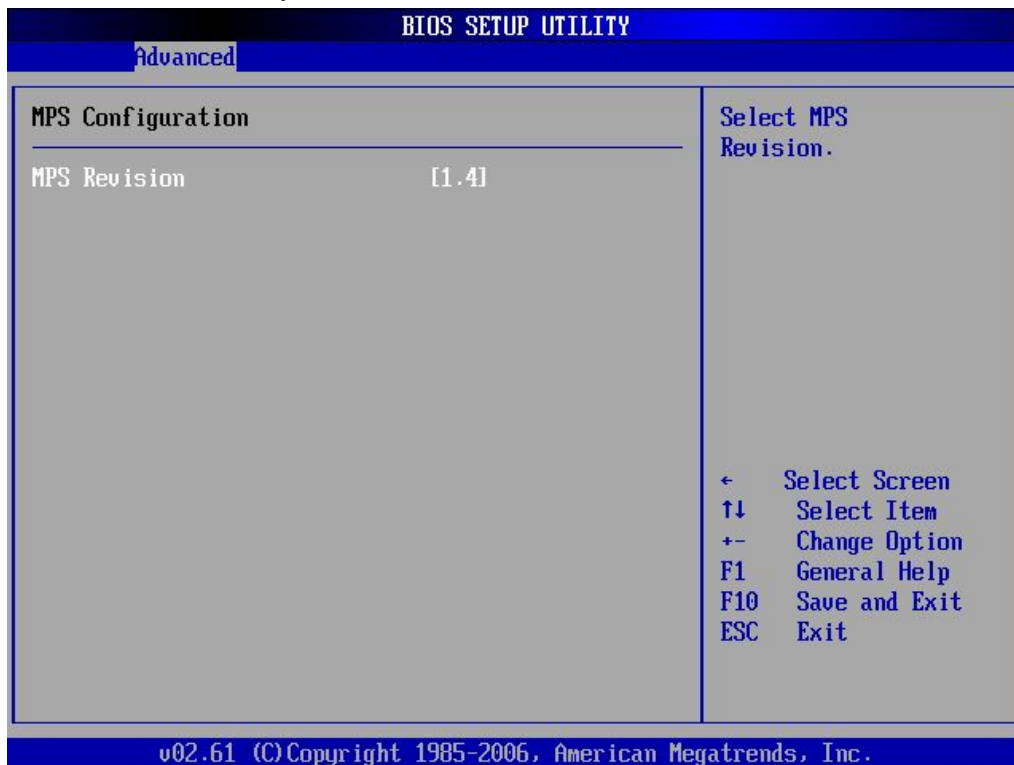

User's Manual

4.4.9 PCI Express Configuration

This sub menu allows you to enable or disable the PCI Express L0s and L1 link power states.

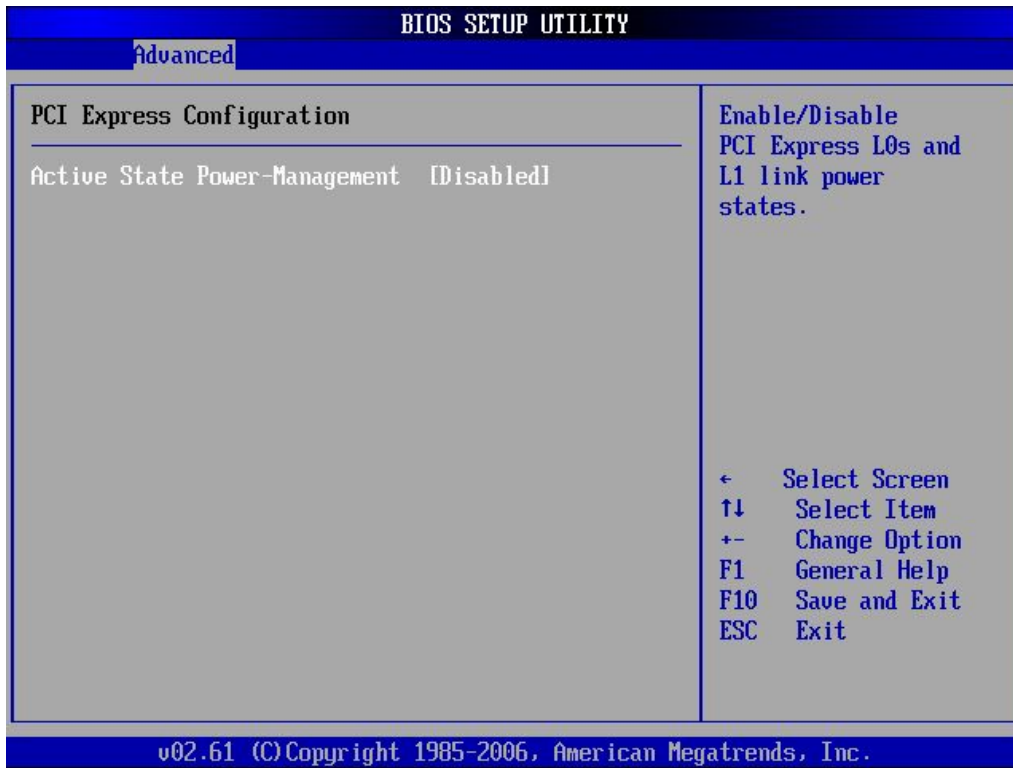

User's Manual

4.4.10 Remote Access Configuration

This sub menu allows you to enable or disable Remote access. If you select [Enabled], below items will show up:

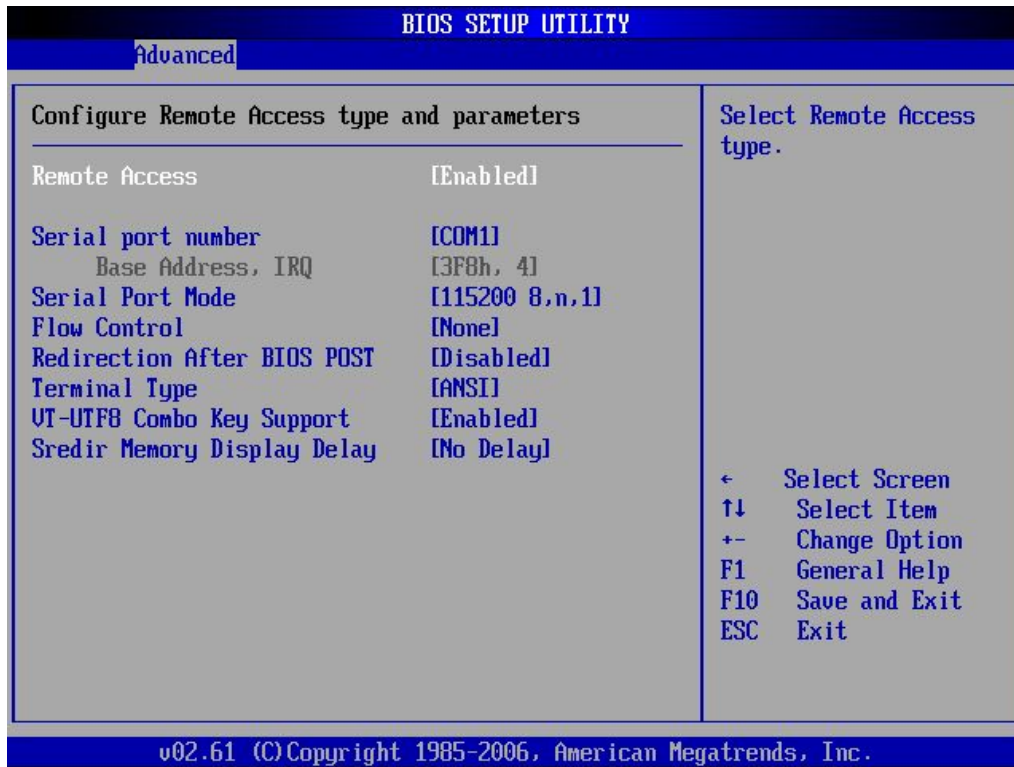

Serial port number: [COM1]

This item allows you to select the serial port for console redirection. Make sure the selected port is enabled.

Base Address, IRQ: [3F8h, 4]

Serial Port Mode: [115200 8,n,1]

This item allows you to select serial port settings.

Flow Control: [None]

This item allows you to select flow control for console redirection.

Redirection After BIOS POST: [Disabled]

This item allows you to set Redirection configuration after BIOS POST.

[Always]: The console redirection is always active.

[Boot Loader]: The console redirection is active during POST and Boot Loader.

[Disabled]: Turns off the console redirection after POST.

User's Manual

Terminal Type: [ANSI]

This item allows you to select the target terminal type.

VT-UTF8 Combo Key Support: [Enabled]

This item allows you to enable or disable VT-UTF8 combination key support for ANSI/VT100 terminals.

Sredir Memory Display Delay: [No Delay]

This item allows you to set the delay in seconds to display memory information.

4.4.11 USB Configuration

This sub menu allows you to change the USB-related features.

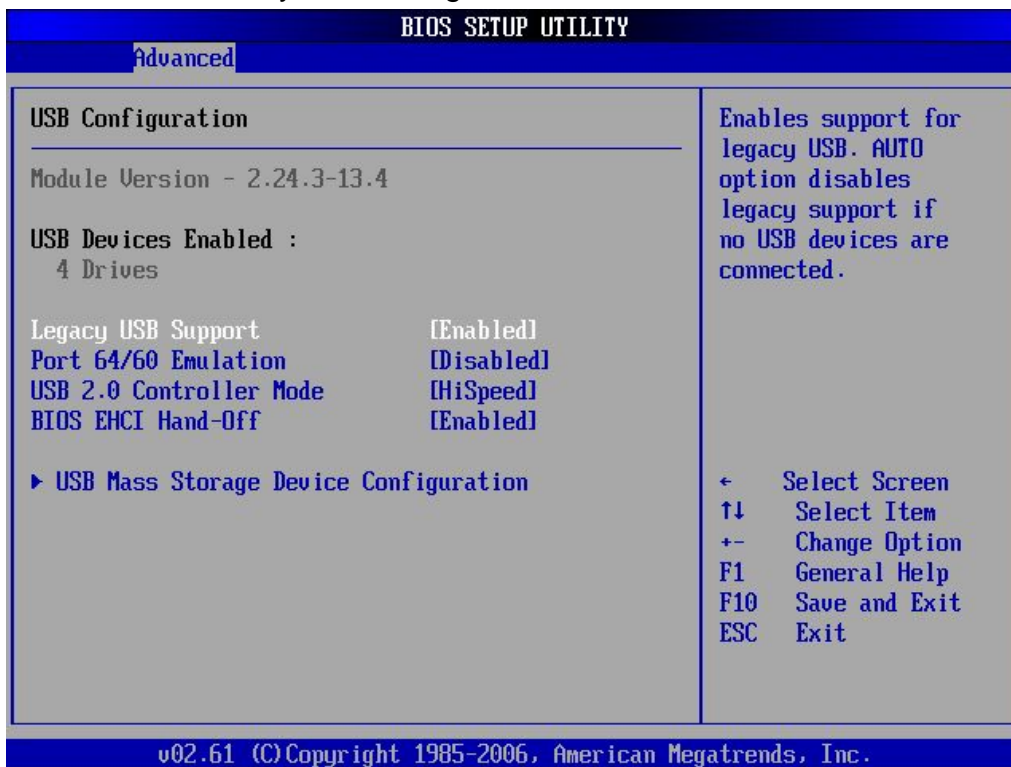

Legacy USB Support: [Enabled]

Enables support for legacy USB. AUTO option disables legacy support if no USB devices are connected.

Port 64/60 Emulation: [Disabled]

This item allows you to enable emulation of I/O ports 64h and 60h so that there is full PS/2 legacy support for USB keyboards and mice. It is also useful in providing USB keyboard and mouse support in Windows NT which does not natively support USB.

USB 2.0 Controller Mode: [HiSpeed]

This item allows you to configure the USB 2.0 controller in HiSpeed (480Mbps) or

User's Manual

FullSpeed (12Mbps).

BIOS EHCI Hand-Off: [Enabled]

This is a work around for OS's without EHCI hand-off support. The EHCI ownership change should claim by EHCI driver.

> USB Mass Storage Device Configuration

The screenshot displays the BIOS Setup Utility interface. At the top, it says "BIOS SETUP UTILITY" and "Advanced". The main screen is titled "USB Mass Storage Device Configuration". It lists settings for four USB devices, each with a "Device #", "Emulation Type", and "Reset Delay". The "Reset Delay" is set to "[20 Sec]". The "Emulation Type" for all devices is "Generic". To the right of the configuration table, there is a description: "Number of seconds POST waits for the USB mass storage device after start unit command." Below this, a legend lists navigation keys: left arrow for "Select Screen", up/down arrows for "Select Item", plus/minus for "Change Option", F1 for "General Help", F10 for "Save and Exit", and ESC for "Exit". At the bottom, the version and copyright information are shown: "v02.61 (C) Copyright 1985-2006, American Megatrends, Inc."

USB Mass Storage Device Configuration	
USB Mass Storage Reset Delay	[20 Sec]
Device #1	Generic
Emulation Type	[Auto]
Device #2	Generic
Emulation Type	[Auto]
Device #3	Generic
Emulation Type	[Auto]
Device #4	Generic
Emulation Type	[Auto]

Number of seconds POST waits for the USB mass storage device after start unit command.

← Select Screen
↑↓ Select Item
+- Change Option
F1 General Help
F10 Save and Exit
ESC Exit

v02.61 (C) Copyright 1985-2006, American Megatrends, Inc.

4.5 PCIPnP Menu

The PCIPnP menu items allow you to change the settings for the advanced PCI/PnP.

↓ Use the PCIPnP Setup option as follows:

1. Choose "PCIPnP" from the main menu. The following screen appears:

BIOS SETUP UTILITY

Main Advanced **PCIPnP** Boot Security Chipset Exit

Advanced PCI/PnP Settings

WARNING: Setting wrong values in below sections may cause system to malfunction.

Clear NURAM	[No]
Plug & Play O/S	[No]
PCI Latency Timer	[64]
Allocate IRQ to PCI UGA	[Yes]
Palette Snooping	[Disabled]
PCI IDE BusMaster	[Enabled]
OffBoard PCI/ISA IDE Card	[Auto]
IRQ3	[Available]
IRQ4	[Available]
IRQ5	[Available]
IRQ7	[Available]
IRQ9	[Available]
IRQ10	[Available]
IRQ11	[Available]

Clear NURAM during System Boot.

← Select Screen
↑↓ Select Item
+- Change Option
F1 General Help
F10 Save and Exit
ESC Exit

v02.61 (C) Copyright 1985-2006, American Megatrends, Inc.

BIOS SETUP UTILITY

Main Advanced **PCIPnP** Boot Security Chipset Exit

IRQ14	[Available]
IRQ15	[Available]
DMA Channel 0	[Available]
DMA Channel 1	[Available]
DMA Channel 3	[Available]
DMA Channel 5	[Available]
DMA Channel 6	[Available]
DMA Channel 7	[Available]
Reserved Memory Size	[Disabled]

Available: Specified DMA is available to be used by PCI/PnP devices.
Reserved: Specified DMA is reserved for use by Legacy ISA devices.

← Select Screen
↑↓ Select Item
+- Change Option
F1 General Help
F10 Save and Exit
ESC Exit

v02.61 (C) Copyright 1985-2006, American Megatrends, Inc.

2. Use the arrow keys to move between items and to select values. Modify the selected fields using the PgUP/PgDN keys. Press the <F1> "Help" key for information on the available options:

Clear NVRAM: [No]

This item allows you to clear NVRAM during system Boot.

Plug & Play O/S: [No]

No: lets the BIOS configure all the devices in the system.

Yes: lets the OS configure Plug & Play devices not required for boot if your system has a Plug & Play operating system.

PCI Latency Timer: [64]

This item allows you to select the value in units of PCI clocks for the PCI device latency timer register. This setting controls how many PCI clocks each PCI device can hold the bus before another PCI device takes over.

Allocate IRQ to PCI VGA: [Yes]

BIOS assigns an IRQ to PCI VGA card if the card requests for an IRQ.

Palette Snooping: [Disabled]

This item allows you to enable or disable the feature. When set to [Enabled], the palette snooping feature informs the PCI devices that an ISA graphics device is installed in the system so that the device can function correctly.

PCI IDE BusMaster: [Enabled]

This item allows you to enable or disable the feature.

Enable: BIOS uses PCI bus mastering for reading/writing to IDE devices.

OffBoard PCI/ISA IDE Card: [Auto]

Some PCI IDE cards may require this to be set to the PCI slot number that is holding the card.

IRQ 3/4/5/7/9/10/11/14/15: [Available]

Available: the specified IRQ is available for use by PCI/PnP devices.

Reserved: the specified IRQ is reserved for use by legacy ISA devices.

DMA Channel 0/1/3/5/6/7: [Available]

Available: the specified DMA is available for use by PCI/PnP devices.

Reserved: the specified DMA is reserved for use by legacy ISA devices.

Reserved Memory Size: [Disabled]

This item allows you to select the reserved memory for legacy ISA devices.

3. After you have finished with the PCIPnP Setup, press the <ESC> key to return to the main menu.

4.6 Boot Menu

↓ Use the **Boot Setup** option as follows:

1. Choose "Boot" from the main menu. The following screen appears:

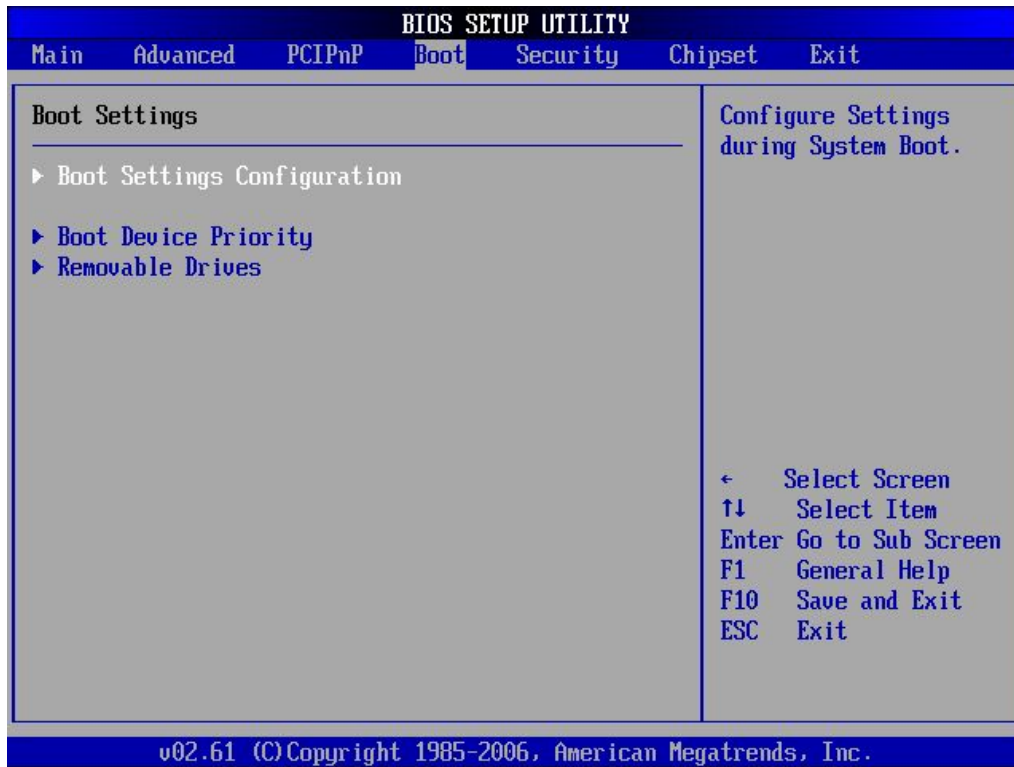

2. Move between items and select values by using the arrow keys. Modify the selected fields using the PnUP/PgDN Keys. For information on the various options, press <F1> key.

3. After you have finished with the Boot setup, press the <ESC> key to return to the main menu.

User's Manual

4.6.1 Boot Settings Configuration

This item is used to configure system boot setting with below sub menus:

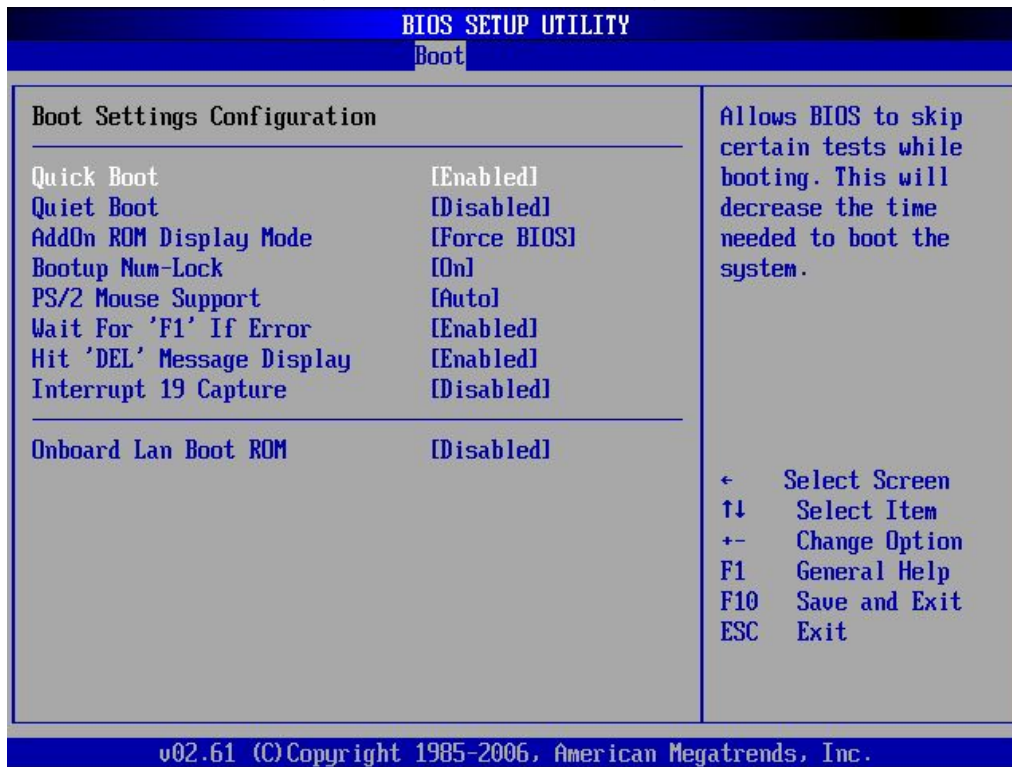

Quick Boot: [Enabled]

This item allows BIOS to skip certain tests (POST, Power On Self Tests) while booting. This will decrease the time needed to boot the system.

Quiet Boot: [Disabled]

This item allows you to enable or disable the full screen logo display feature. Disabled: displays normal POST messages.

AddOn ROM Display Mode: [Force BIOS]

Allows you to set the display mode for option ROM.

Bootup Num-Lock: [On]

Allows you to select the Power-on state for the Num-Lock.

PS/2 Mouse Support: [Auto]

Allows you to select support for PS/2 mouse.

Wait For 'F1' If Error: [Enabled]

Waits for F1 key to be pressed if error occurs.

Hit 'DEL' Message Display: [Enabled]

Displays "Press DEL to run Setup" in POST.

Interrupt 19 Capture: [Disabled]

This item allows the option ROMs to trap Interrupt 19.

Onboard LAN Boot ROM: [Disabled]

This item allows you to enable or disable the Onboard LAN Boot function.

4.6.2 Boot Device Priority

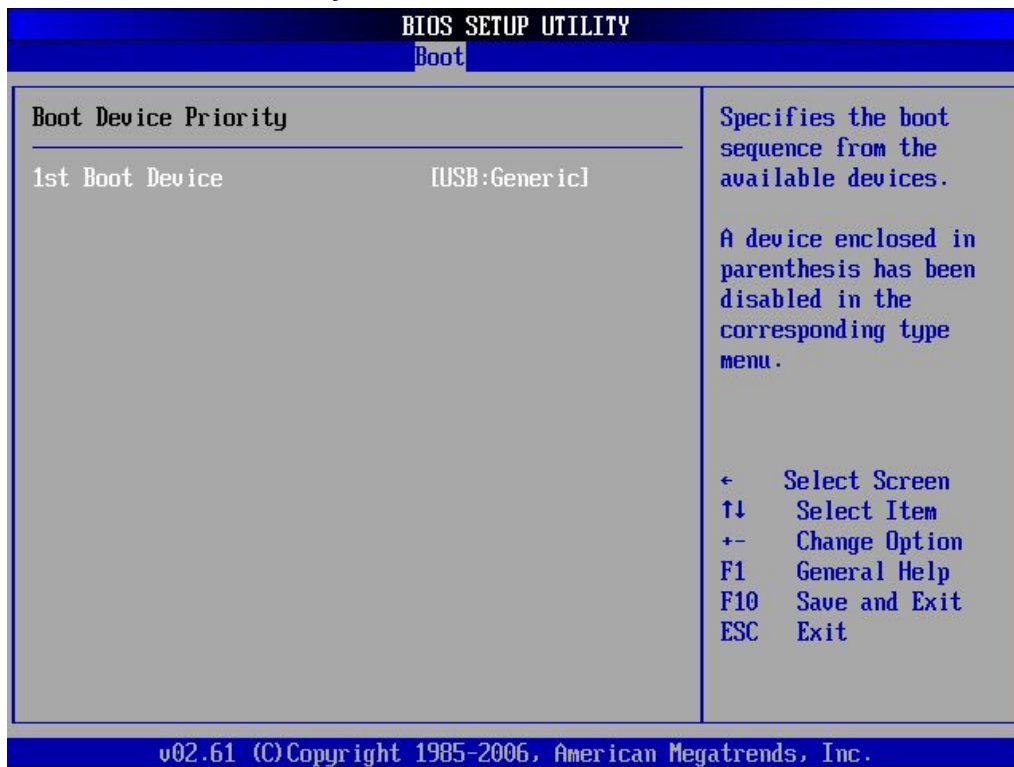

1st Boot Device: [USB: Generic]

This item allows you to set the boot priority. Specifies the boot sequence for the available devices. A device enclosed in parenthesis has been disabled in the corresponding type menu.

User's Manual

4.6.3 Removable Drives

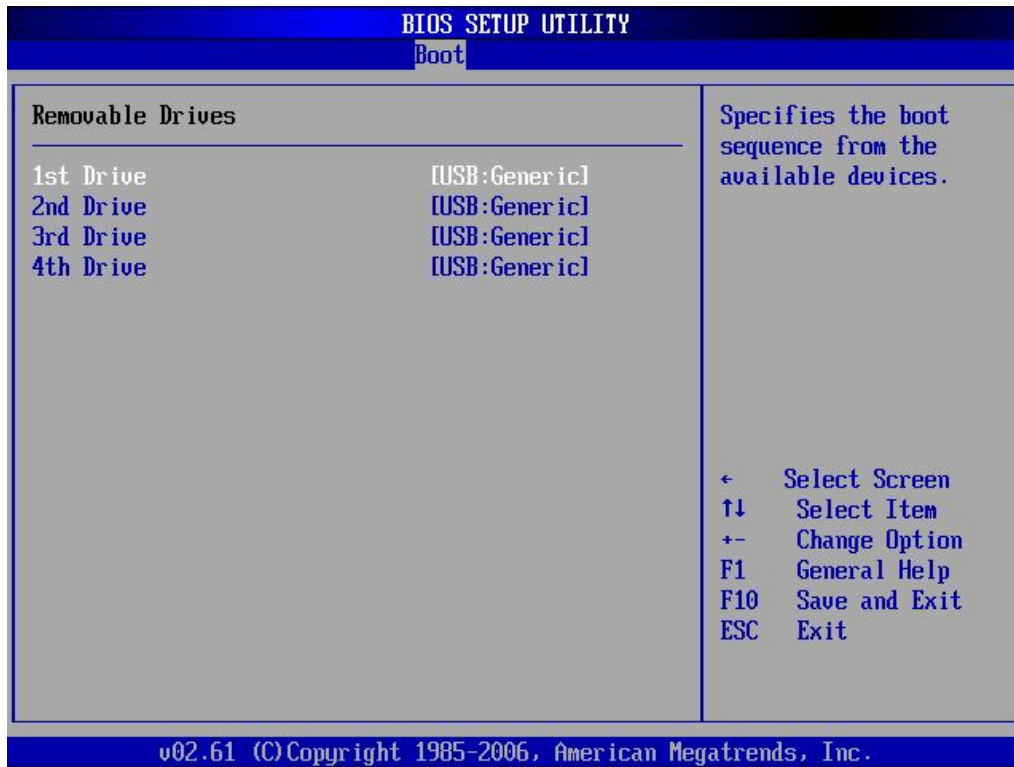

1st/2nd/3rd/4th Drive: [USB: Generic]

This item is used to specify the boot sequence for available devices.

4.7 Security Menu

↓ Use the Security Setup option as follows:

1. Choose "Security" from the main menu. The following screen appears:

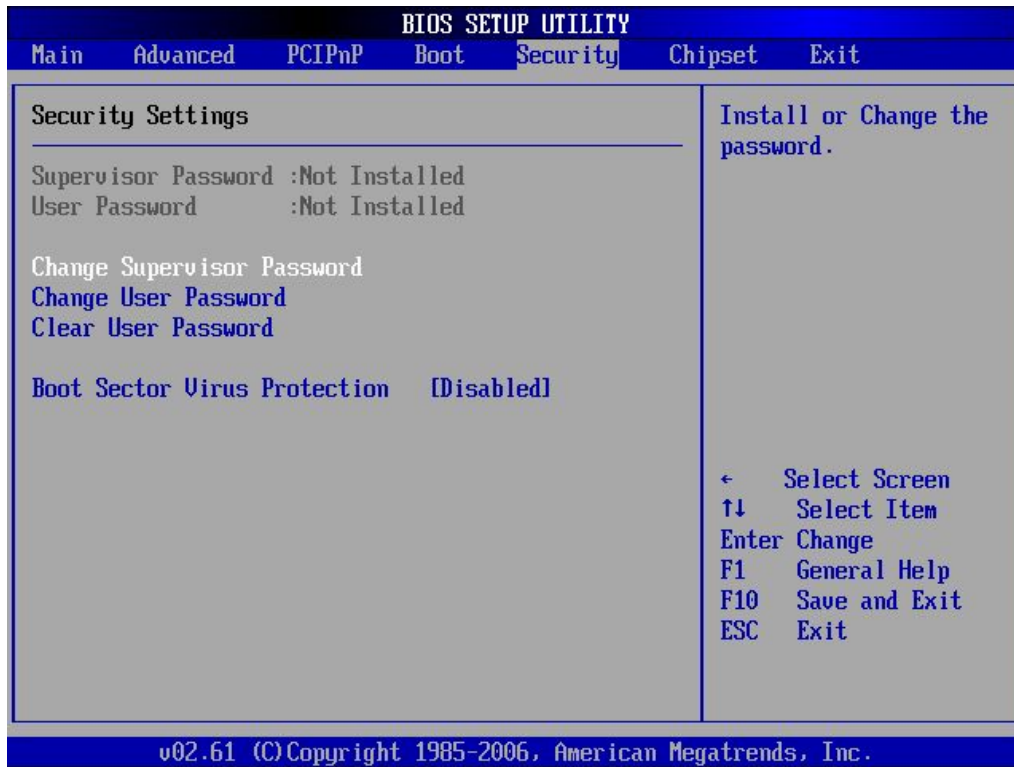

2. Move between items and select values by using the arrow keys. Modify the selected fields using the PgUP/PgDN keys. Please press the <F1> key for information on the various options.
3. After you have finished with the Security setup, press the <ESC> key to return to the main menu.

Change Supervisor Password:

This item allows you to set or change the supervisor password. The Supervisor Password item on top of the screen shows the default Not Installed. After you have set a password, this item shows Installed.

Change User Password:

This item allows you to set or change the user password. The User Password item on top of the screen shows the default Not Installed. After you have set a password, this item shows Installed.

Clear User Password:

This item allows you to clear the user password.

Boot Sector Virus Protection: [Disabled]

This item allows you to enable or disable the boot sector virus protection. If enabled, AMI BIOS will issue a warning when a virus or program attempts to write to the hard disk's boot sector or attempts to execute disk format command.

4.8 Chipset Menu

↓ Use the Chipset Setup option as follows:

1. Choose "Chipset" from the main menu. The following screen appears.

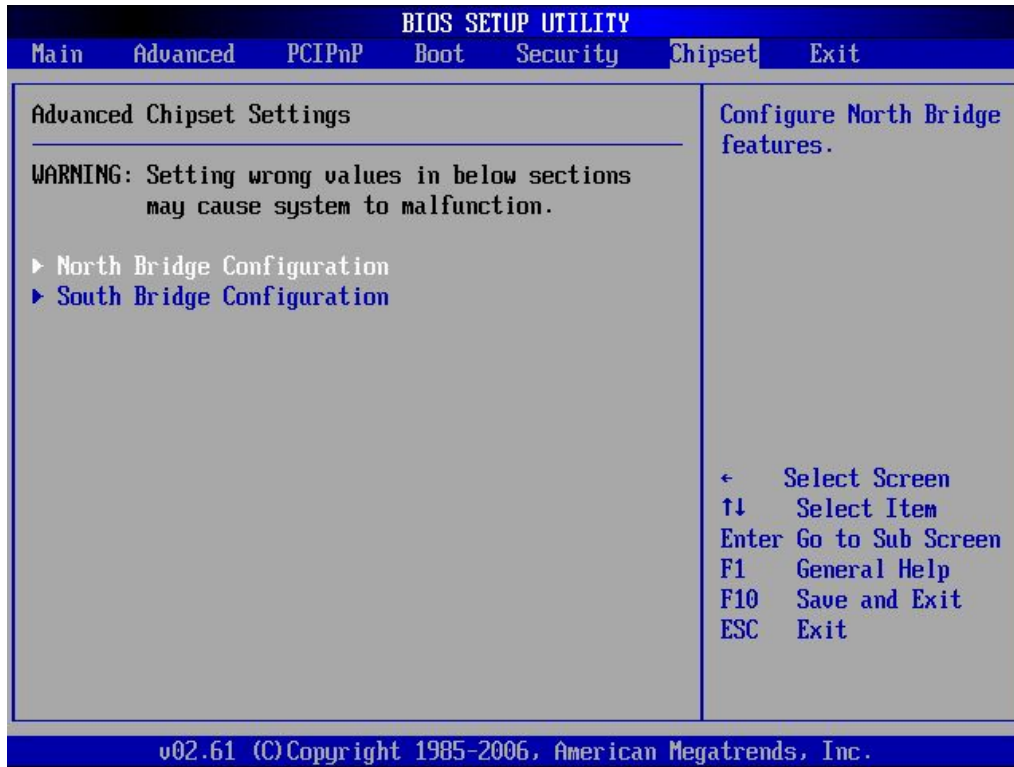

2. Move between items and select values by using the arrow keys. Modify the selected field the PgUP/PgDN keys. For information on the various options, press <F1> key.

After you have finished with the Chipset Setup, press the <ESC> key to return to the main menu.

4.8.1 North Bridge Configuration

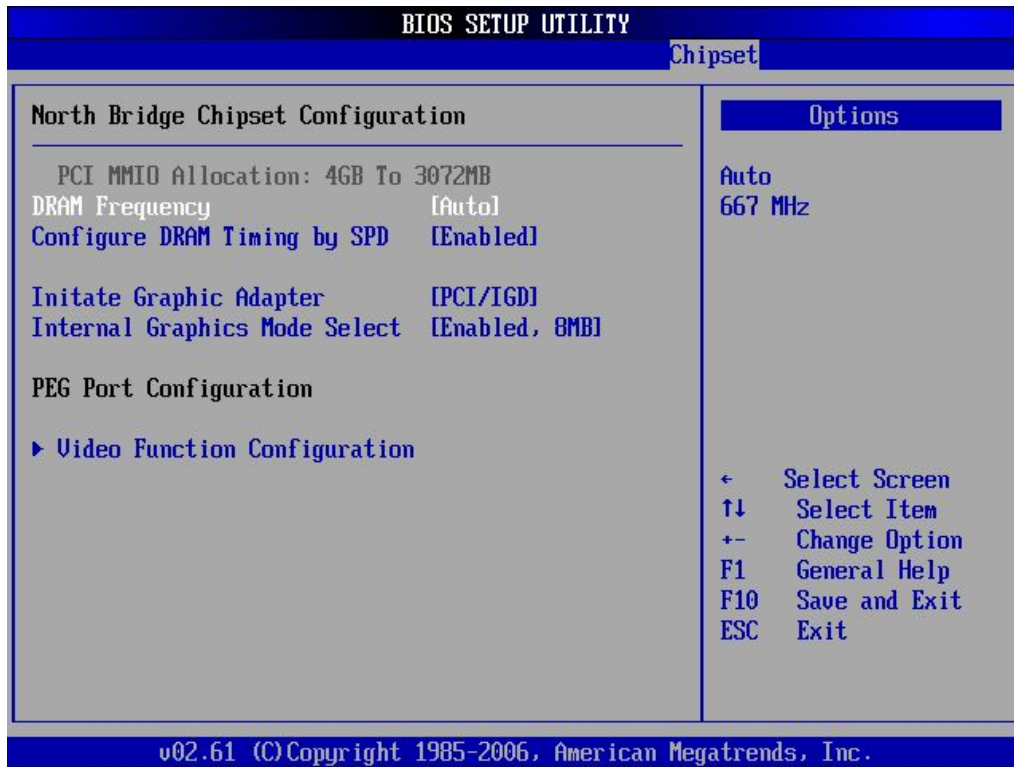

DRAM Frequency: [Auto]

This item allows you to configure the clock frequency of the installed DRAM. If [Auto] is selected, the BIOS will detect the installed memory modules and assign the appropriate frequency automatically.

Configure DRAM Timing by SPD: [Enabled]

This item allows you to enable or disable the above feature.

[Enabled]: The DRAM timing parameters are set according to the DRAM SPD.

[Disabled]: You can manually set the DRAM timing parameters.

Initiate Graphic Adapter: [PEG/PCI]

This item shows the primary graphic adapter.

Internal Graphics Mode Select: [Enabled, 8MB]

This item allows you to configure the internal graphics mode and memory size.

PEG Port Configuration

> Video Function Configuration

User's Manual

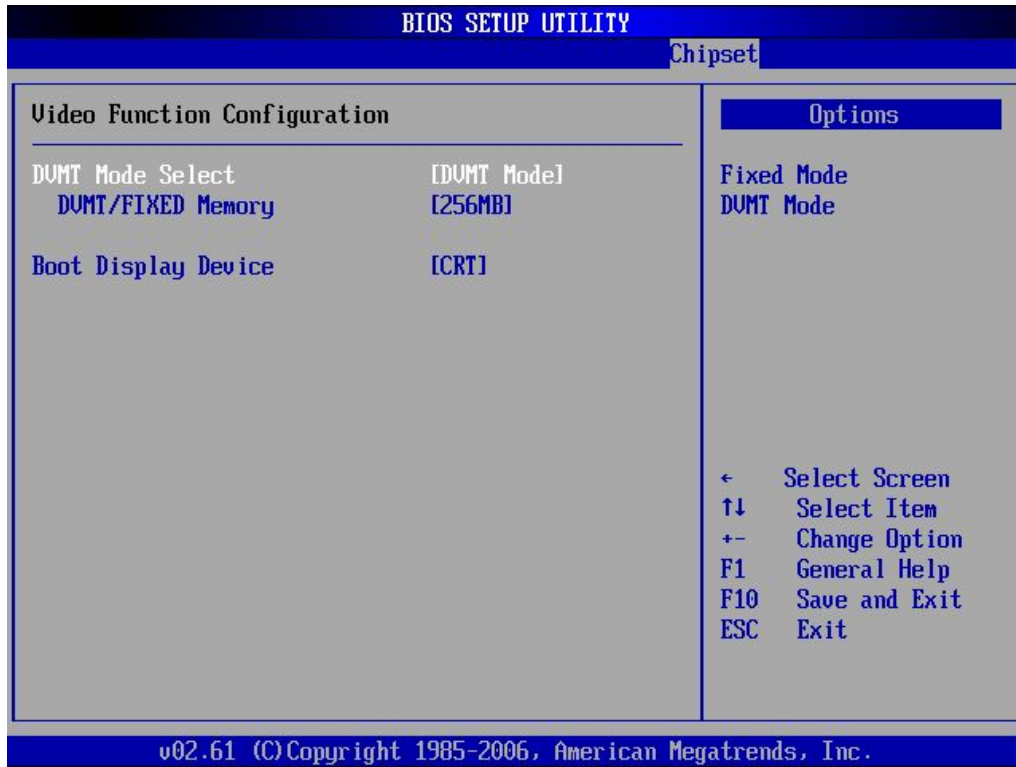

DVMT Mode Select: [DVMT Mode]

This item allows you to select the DVMT (Dynamic Video Memory Technology) Mode.

[Fixed mode]: a fixed-size fragment of the system memory is allocated to the graphics core.

[DVMT mode]: the graphics driver allocates memory as needed for running graphics applications and cooperatively uses this memory with other system components.

DVMT/FIXED Memory: [256MB]

This item allows you to adjust the shared memory size.

Boot Display Device: [CRT]

This item allows you to configure the Boot Display Device.

User's Manual

4.8.2 South Bridge Configuration

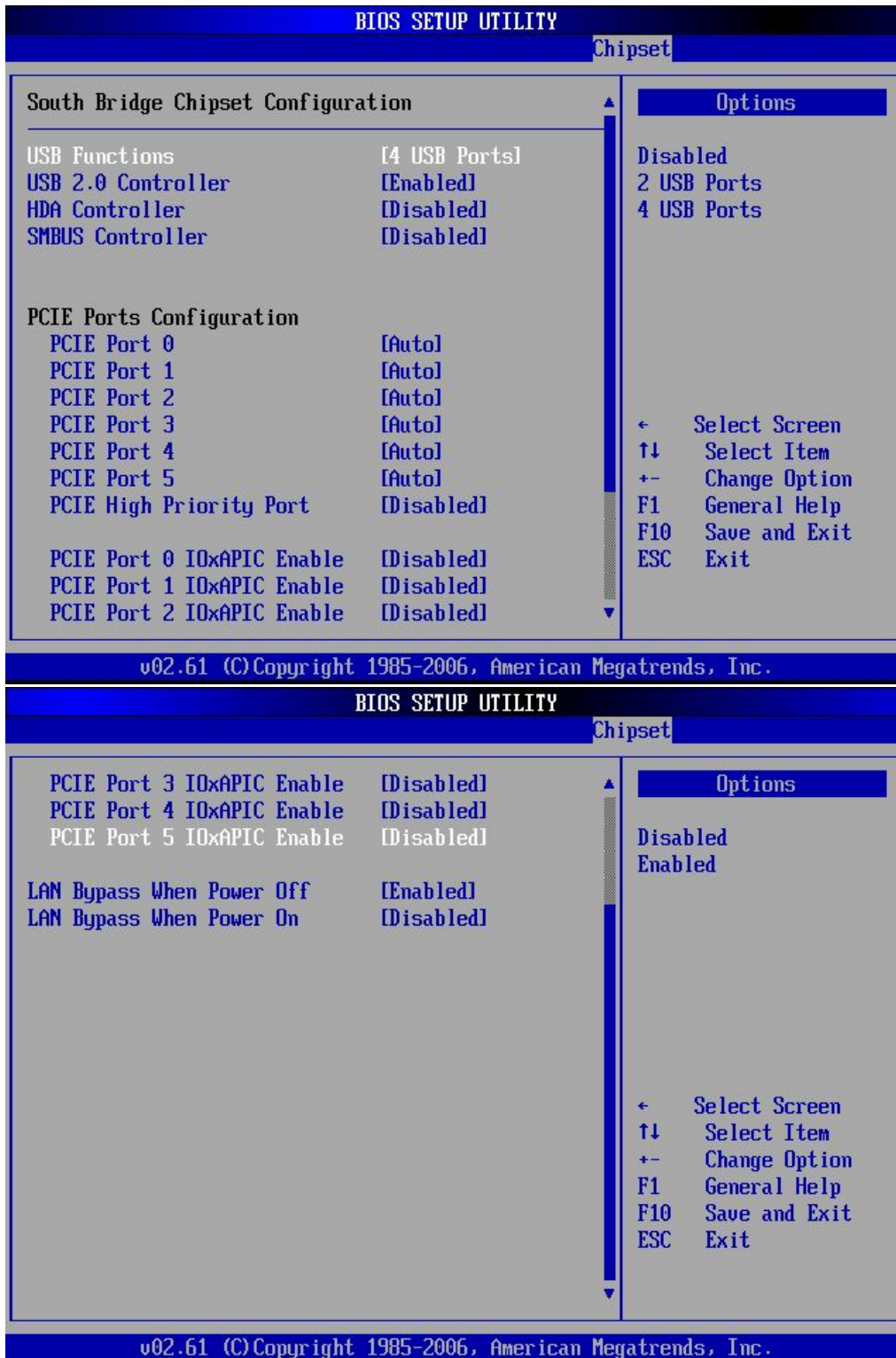

USB Functions: [4 USB Ports]

This item allows you to setup the USB ports.

USB 2.0 Controller: [Enabled]

This item allows you to enable or disable the USB 2.0 controller.

HDA Controller: [Disabled]

This item allows you to enable or disable the HDA controller.

SMBUS Controller: [Disabled]

This item allows you to enable or disable the SMBUS Controller.

PCIE Ports Configuration:

PCIE Port0/1/2/3/4/5: [Auto]

PCIE High Priority Port: [Disabled]

PCIE Port0/1/2/3/4/5 IOx APIC Enable: [Disabled]

LAN Bypass When Power Off: [Enabled]

This item allows you to enable or disable the LAN bypass function when Power Off.

LAN Bypass When Power On: [Disabled]

This item allows you to enable or disable the LAN bypass function when Power On.

4.9 Exit

The item allows you to save or discard your changes to the BIOS items, and load the optimal defaults or failsafe defaults for the BIOS items.

↓ Use the Exit option as follows:

1. Choose "Exit" from the main menu, the following screen appears.

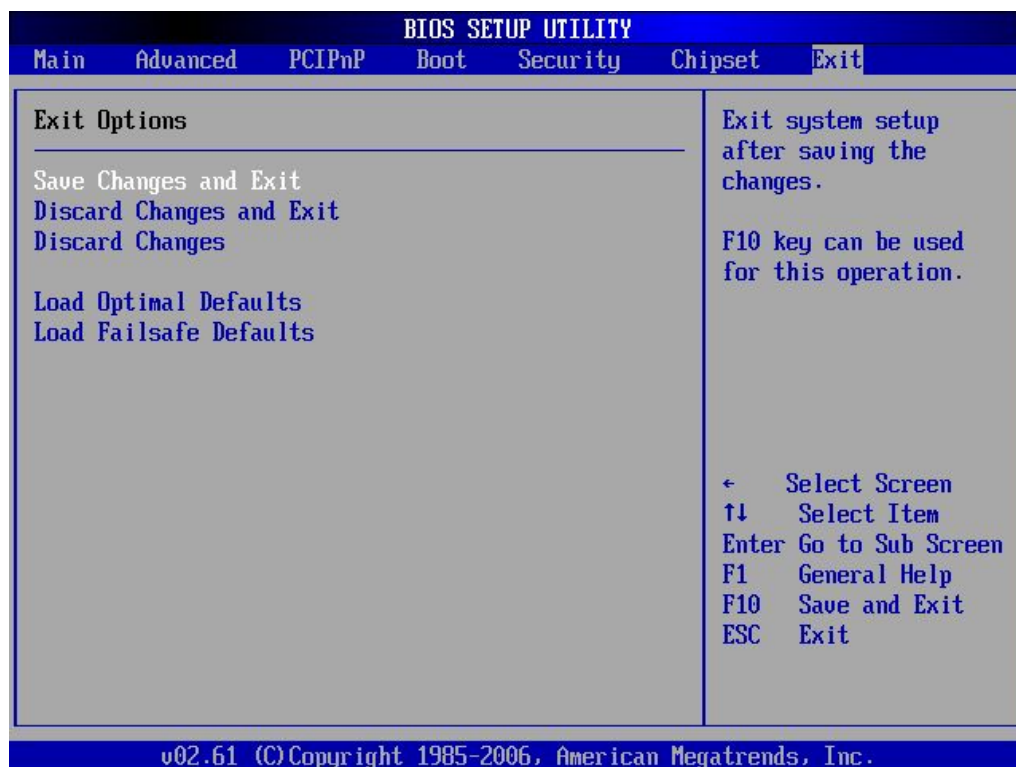

2. Move between items and select values by using the arrow keys. Modify the selected fields using the PgUP/PgDN keys. For information on the various options, please press <F1> key.
3. Please press the <ESC> key to return the main menu after finishing with the Exit Options.

Save Changes and Exit:

Save changes of values to CMOS and exit the CMOS setup program. F10 key can be used for this operation.

Discard Changes and Exit:

Discard all CMOS changes and exit the CMOS setup program. ESC key can be used for this operation.

Discard Changes:

Discard all CMOS changes and load the previously saved values. F7 key can be used for this operation.

Load Optimal Defaults:

This item allows you to load optimal defaults for each of the parameters on the Setup menus, which will provide the best performance settings for your system. F9 key can be used for this operation.

Load Failsafe Defaults:

This item allows you to load failsafe defaults for each of the parameters on the Setup menus, which will provide the most stable performance settings. F8 key can be used for this operation.

Chapter 5. Utility & Driver Installation

Install the GbE modules properly before installing the OS, driver or other software.

5.1 Operation System Support

PL-80260 can support Windows® and Linux® operating systems as follows. Before installation, please check your OS version. If your OS is not in the following list, upgrade your OS version.

OS	Version
DOS	DOS 6.22
Windows®	Windows® XP Professional SP2 Windows® XP Professional SP3
Linux®	Fedora 5 Fedora 6 Fedora 7 Fedora 8 Fedora 9 Fedora 10

5.2 System Driver Installation

PL-80260 offers the system driver in the setup CD. Install the driver following these procedures.

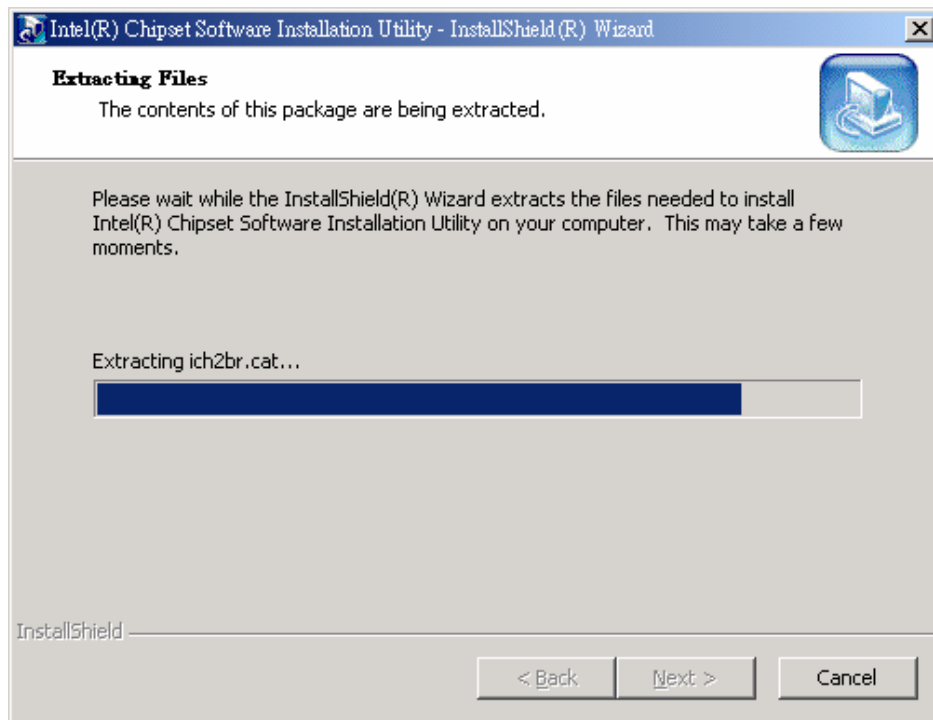

5.3 LAN Driver Installation

PL-80260 offers the LAN driver in the setup CD. Click the Autorun file and install the driver following these procedures.

1. Insert the setup CD of PL-80260 into your CD-ROM drive.
2. Choose the Drivers file to click the Autorun icon.
3. Follow the procedures to finish the installation.

Appendix A: Programming the Watchdog Timer

The PL-80260 provides a watchdog timer that resets the CPU or enables LAN bypass mode. This function ensures greater system reliability in industrial stand-alone and unmanned environments.

In order to enable the watchdog timer, you have to output the value of the watchdog timer interval to the controller. The value range is from 01H to FFH, and the related time watchdog timer interval is 1 sec to 255 sec.

Data	Timer interval
00	Disabled
01	1 sec
02	2 sec
*	*
*	*
FF	255 sec

If you want to disable the watchdog timer, just set the timer interval value to 00H.

After setting the timer interval value, the watchdog timer begins to count down. You have to refresh the watchdog timer, so that the watchdog timer will return to its initial value, otherwise, your system will reset after a time-out. The following program shows how to set the watchdog timer:

User's Manual

ASSEMBLY LANGUAGE

DOS DEBUG

Program 1: Initializing the watchdog controller

MOV DX,2EH	O 2E 87
MOV AL,87H	O 2E 87
OUT DX,AL	
OUT DX,AL	
MOV DX,2EH	O 2E 07
MOV AL,07H	O 2F 08
OUT DX,AL	
MOV DX,2FH	
MOV AL,08H	
OUT DX,AL	
MOV DX,2EH	O 2E 30
MOV AL,30H	O 2F 01
OUT DX,AL	
MOV DX,2FH	
MOV AL,01H	
OUT DX,AL	

Program 2: Writing a watchdog timer interval value

MOV DX,2EH ;Set timer interval value to xx seconds	O 2E F6
MOV AL,F6H	O 2F XX
OUT DX,AL	O 2E AA
MOV DX,2FH	
MOV AL,XXH ; Timer interval *** see note ***	
OUT DX,AL	
MOV DX,2EH	
MOV AL,AAH	
OUT DX,AL	

Program 3: Disable the watchdog timer

MOV DX,2EH	O 2E 87
MOV AL,87H	O 2E 87
OUT DX,AL	
OUT DX,AL	
MOV DX,2EH ; Set timer interval value to 0 seconds	O 2E F6
MOV AL,F6H	O 2F 00
OUT DX,AL	O 2E AA
MOV DX,2FH	
MOV AL,00H ; Timer interval 00H,(= disable)	
OUT DX,AL	
MOV DX,2EH	
MOV AL,AAH	
OUT DX,AL	

Note: This XX value range is from 01H to FFH and the related watchdog timer interval is 1 sec. to 255 sec. (as noted in the previous description).

Using the Demo Program

Update the System BIOS as follows:

1. Run Program 1
2. Run Program 2 (load the timer interval of 1EH, 30 seconds)
3. Run your Application Program #1 (**Be sure your Application Program will finish within 30 seconds**)
4. Run Program 3 (Load the timer interval of 00H and disable the watchdog timer function)

Appendix B: LAN Bypass Function *(optional)*

The power on default for CN19 & CN20 LAN ports is set to normal state.

How to control LAN 1&2 bypass function with watchdog timer

Please follow below steps to set the LAN bypass function control with watchdog timer:

1. Setup jumper JP5 to 1-2 shorted [default] to enable bypass function.
2. Setup JP4 to 2-3 to enable bypass function by watchdog timer.
3. Refer to Appendix A to set timer interval value and enable watchdog timer.

After setting the timer interval value, the watchdog timer begins to count down. You have to refresh the watchdog timer, so that the watchdog timer will return to its initial value; otherwise, your system will set CN19 & CN20 LAN ports to bypass state after a time-out.

Note: Once the watchdog timer time-out you need to restart the system to reset the timer.

How to control LAN 1&2 bypass function by GPIO

Please follow below steps to set the LAN bypass function control by GPIO:

1. Setup jumper JP5 to 1-2 shorted [default] to enable bypass mode.
2. Setup JP4 to 1-2 [default] to enable bypass function by GPIO.
3. Refer to the program code and set CN19 & CN20 LAN ports to Bypass state or Normal state.

LAN 1 & 2: GPIO20

Bypass state:	Normal state:
MOV DX, 050CH IN EAX, DX AND EAX, 0FFEFFFFFH OUT DX, EAX	MOV DX, 050CH IN EAX, DX AND EAX, 0FFEFFFFFH OR EAX, 00100000H OUT DX, EAX

Appendix C: System Resources

Interrupt Controller:

The PL-80260 is a fully PC compatible appliance. If you would like to use extra add-on cards, please make sure that the IRQs do not conflict.

Any remaining IRQs then may be assigned to this PCI Bus. You are able to use Microsoft's Diagnostic (MDS.EXE) utility included in Windows directory to see their map.

IRQ	Assignment
IRQ0	Timer
IRQ1	Keyboard
IRQ2	Cascade
IRQ3	COM2
IRQ4	COM1
IRQ5	PCI-PCI Bridge
IRQ6	FDD Controller
IRQ7	LPT1
IRQ8	RTC
IRQ9	Free
IRQ10	PCI-PCI Bridge
IRQ11	PCI-PCI Bridge
IRQ12	Free
IRQ13	Coprocessor
IRQ14	IDE Controller
IRQ15	IDE Controller

DMA Channel Assignment:

Channel 4 is by default used to cascade to two controllers

Channel	Assignment
DMA0	Free
DMA1	Free
DMA2	FDD Controller
DMA3	Free
DMA4	Cascade
DMA5	Free
DMA6	Free
DMA7	Free

User's Manual

Memory Map:

The following table indicates memory of PL-80260. The address ranges specify the runtime code length.

Memory below 1MB (1MB ~ 640KB)

Address Range	Type	Owner
A0000 ~ AFFFF	ISA	VGA Adapter
B0000 ~ BFFFF	ISA	VGA Adapter
C0000 ~ CD9FF	ISA	Adapter ROM
E0000 ~ EFFFF	ISA	Mapped RAM
F0000 ~ FFFFF	ISA	System BIOS

Memory above 1MB (1MB ~ 65535KB)

Address Range	Type	Owner
D0000000~DFFFFFFF7	PCI	VGA Adapter
FE400000~FE4FFFFFF	PCI	VGA Adapter
FE500000~FE57FFFF	PCI	VGA Adapter
FE600000~FE6FFFFFF	PCI	PCI-PCI Bridge
FE700000~FE7FFFFFF	PCI	PCI-PCI Bridge
FE800000~FE8FFFFFF	PCI	PCI-PCI Bridge
FE900000~FE9FFFFFF	PCI	PCI-PCI Bridge
FEA00000~FEAFFFFFF	PCI	PCI-PCI Bridge
FEB00000~FEBFFFFFF	PCI	PCI-PCI Bridge

System Memory Map

Start High	Start Low	Size High	Size	Type
00000000	00000000	00000000	0009FC00	Available
00000000	0009FC00	00000000	00000400	Reserved
00000000	000E0000	00000000	00020000	Reserved
00000000	00100000	00000000	3F5E0000	Available
00000000	3F6E0000	00000000	00010000	Reserved
00000000	3F6F0000	00000000	00010000	Reserved
00000000	FEE00000	00000000	00001000	Reserved
00000000	FFA00000	00000000	00600000	Reserved

User's Manual

I/O Map:

The addresses shown in the table are typical locations

I/O Port	Assignment
0 ~ F	AT DMA controller
20 ~ 21	AT interrupt controller
2E ~ 2F	Motherboard Resource
40 ~ 43	8254 Compatible Programmable Timer
60	IBM Enhanced keyboard controller
61	AT Style Speaker
64	IBM Enhanced keyboard controller
70 ~ 71	Real Time Clock
72 ~ 75	Motherboard Resource
80 ~ 90	AT DMA controller
94 ~ 9F	AT DMA controller
A0 ~ A1	AT interrupt controller
C0 ~ DE	AT DMA controller
F0 ~ FF	Math Coprocessor
170 ~ 177	IDE Controller
1F0 ~ 1F7	IDE Controller
2F8 ~ 2FF	COM2
376	IDE Controller
378 ~ 37A	LPT1
3B0 ~ 3BB	VGA Adapter
3C0 ~ 3DF	VGA Adapter
3F6	IDE Controller
3F8 ~ 3FF	COM1
4D0 ~ 4D1	Motherboard Resource
500 ~ 53F	Motherboard Resource
800 ~ 87F	Motherboard Resource
8F0 ~ 8FF	Motherboard Resource
A00 ~ A0F	Motherboard Resource
CF8 ~ CFF	Motherboard Resource
7880 ~ 7886	VGA Adapter
7C00 ~ 7C1E	USB Controller
8000 ~ 801E	USB Controller

User's Manual

8080 ~ 808E	IDE Controller
8400 ~ 840E	IDE Controller
8480 ~ 8482	IDE Controller
8800 ~ 8806	IDE Controller
8880 ~ 8882	IDE Controller
8C00 ~ 8C06	IDE Controller
9000 ~ 9FFF	PCI-PCI Bridge
A000 ~ AFFF	PCI-PCI Bridge
B000 ~ BFFF	PCI-PCI Bridge
C000 ~ CFFF	PCI-PCI Bridge
D000 ~ DFFF	PCI-PCI Bridge
E000 ~ EFFF	PCI-PCI Bridge
FFA0 ~ FFAE	IDE Controller

User's Manual

Appendix D: Cable Development Kit

The PL-80260 offers some cables for development use.

DK001

Item & Description	Part No.	Qty
Ethernet Cat.5 Cable 2M/ RoHS	CB-EC5200-00	1
Cross Over 2M Color/ RoHS	CB-CO5202/4-00	1
RJ45 to DB9 2M Cable/ RoHS	CB-RJDB91-00	1
2m null modem cable/ RoHS	CB-DB9200-01	1
VGA CABLE (2mm) 15CM/ RoHS	CB-IVGA01-00	1
KB/MS CABLE 15CM/ RoHS	CB-IPS200-00	1
USB CABLE/ RoHS	CB-IUSB01-00	1

CB-EC5200-00



CB-CO5202/4-00



CB-RJDB91-00



CB-DB9200-00



CB-IVGA01-00



CB-IPS200-00



CB-IUSB01-00

