

Ceramic Disc Capacitors

NCD Series Class I

TEMPERATURE COMPENSATING AND TEMPERATURE STABLE TYPES (CLASS I)



FEATURES

- PROVIDES AN ACCURATE, PREDICTABLE LINEAR CAPACITANCE CHANGE WITH VARIATIONS IN OPERATING TEMPERATURE
- NPO TYPES PROVIDE DRIFT FREE PERFORMANCE
- TIGHT TOLERANCES AVAILABLE
- AVAILABLE WITH FORMED LEADS AND ON TAPE

*See Part Number System for Details

SPECIFICATIONS

Temperature Characteristics		NPO	N150	N750	SL	N1500	N3300
Operating Temperature Range		-30°C ~ +85°C					
Capacitance Range		0.5 ~ 470pF	3.0 ~ 27pF	22 ~ 470pF	0.5 ~ 1000pF	22 ~ 2200pF	47 ~ 1000pF
Standard Tolerance		±5% (J)					
Capacitance Change Over Temperature Range		±1%	-1 ~ +2%	-5% ~ +7.5%	-5% ~ +9%	-10% ~ +20%	-13% ~ +12%
Q Factor (Min. 1MHz)		1000 (C≥30pF) 400+20C (<30pF)				500 (C≥30pF) 200+10C (<30pF)	
Insulation Resistance		Minimum 10,000 Megohms					
Temperature Coefficient		0±60ppm	N150±60ppm	N750±120ppm	N330±500ppm	N1500±250ppm	N3300±500ppm
Working Voltage Range		50Vdc ~ 1KVdc					
Dielectric Withstanding Voltage (Test Voltage)		2.5 Times Rated Voltage For Not Less Than 1 Second, 50mA Maximum					
Load Life Test @ 85°C 1,000 Hours	Cap. Change	±3%	±5%	±8%	±15%	±30%	±50%
	Q Factor (min.)	Shall Conform To Initial Measurements Above					
	I.R. (min.)	10,000 Megohms					
Test Conditions		<1,000pF; 1MHz, 1.2Vrms Max., ≥1,000pF; 1KHz, 1.2Vrms Max.					

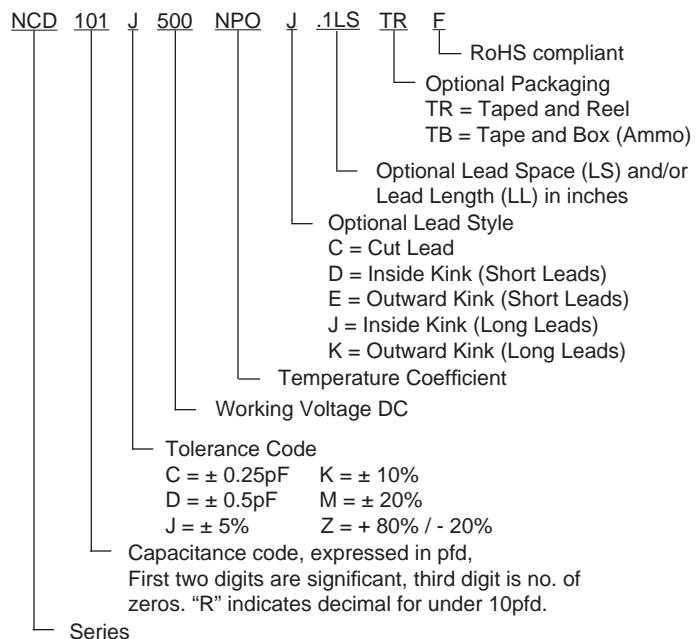
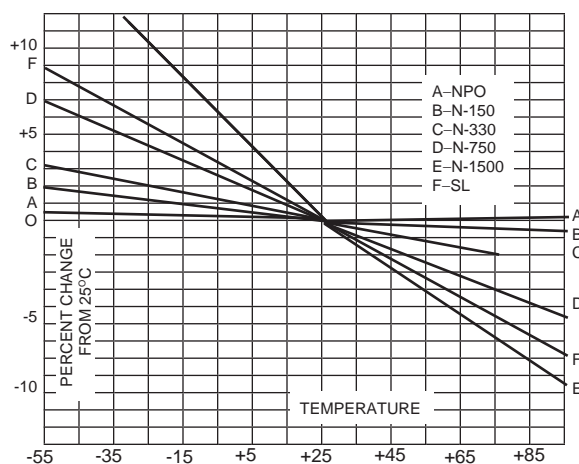

Ceramic Disc Capacitors

NCD Series Class I

Lead Spacing (mm) - S				
Body Diameter	Standard Bulk	Standard T&R	Optional Bulk mm (inches)	Optional T&R mm (inches)
5 ~ 11	6.35 ± 0.8	5.0 ± 0.8	5.0 ± 0.8 (0.2LS)	2.5 ± 0.8 (0.1LS)
≥12	6.35 ± 0.8	5.0 ± 0.8	7.5 ± 0.8 (0.295LS)	7.5 ± 0.8 (0.295LS)
			10.0 ± 0.8 (0.395LS)	10.0 ± 0.8 (0.395LS)

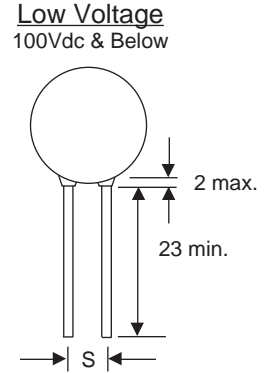
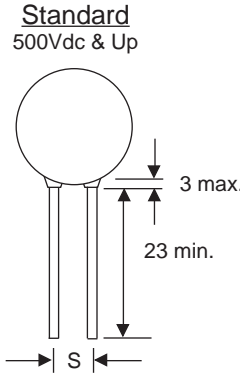

LEAD DIAMETER
0.6MM IS STANDARD

BODY THICKNESS
2 ~ 4MM DEPENDENT ON CV

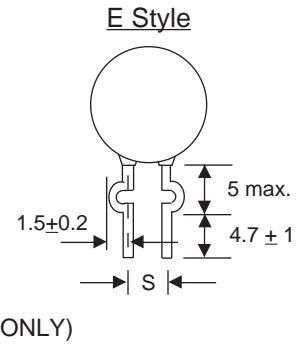
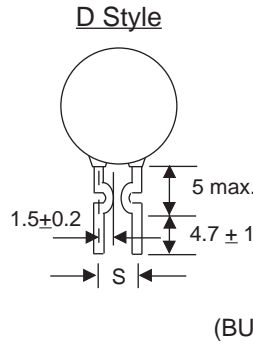
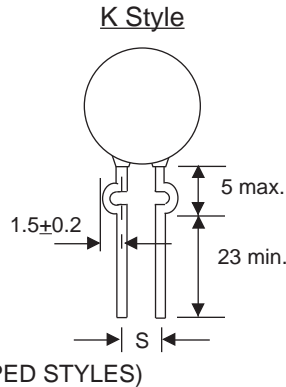
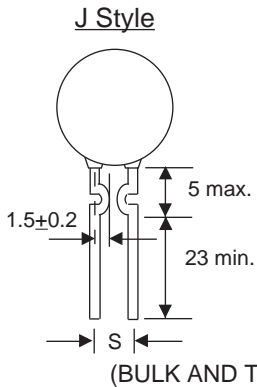

STANDARD PRODUCTS AND MAXIMUM DIAMETER (mm) BY T.C. AND VOLTAGE

Cap. (pF)	NPO			N150			N750			SL			N1500			N3300		
	Working Voltage (Vdc)																	
	50 100	500	1K	50 100	500	1K	50 100	500	1K	50 100	500	1K	50 100	500	1K	50 100	500	1K
0.5 ~ 18	6	6	6	6	6	7	-	-	-	6	6	6	-	-	-	-	-	-
20	6	6	6	6	7	8	6	6	6	6	6	6	-	-	-	-	-	-
22	6	6	6	6	7	8	6	6	6	6	6	6	6	6	6	-	-	-
27	6	6	6	7	8	9	6	6	6	6	6	6	6	6	6	-	-	-
33	6	6	7	-	-	-	6	6	7	6	6	6	6	6	6	-	-	-
39	6	7	7	-	-	-	6	6	7	6	6	6	6	6	6	-	-	-
47	6	7	8	-	-	-	6	7	8	6	6	6	6	6	6	-	6	-
56	7	7	8	-	-	-	7	7	8	6	6	6	6	6	6	-	6	6
68	7	7	9	-	-	-	7	7	9	6	6	6	6	6	6	-	6	6
75	7	7	9	-	-	-	7	7	9	6	6	7	6	6	7	-	6	6
82	7	7	9	-	-	-	7	7	9	6	6	7	6	6	7	6	6	6
100	8	8	10	-	-	-	8	8	10	6	6	7	6	7	7	6	6	6
120	8	8	10	-	-	-	8	8	10	6	6	7	6	7	7	6	6	6
150	9	9	12	-	-	-	9	9	12	6	7	8	6	8	8	6	6	7
180	9	9	14	-	-	-	9	9	14	6	7	8	6	8	8	6	7	7
220	10	10	16	-	-	-	10	10	16	7	8	9	7	9	9	7	7	7
270	12	12	16	-	-	-	12	12	16	8	9	10	8	9	10	7	7	7
330	14	14	18	-	-	-	14	14	18	8	10	12	8	10	12	7	7	8
470	16	16	20	-	-	-	16	16	20	9	12	14	9	12	14	7	8	9
560	-	-	-	-	-	-	-	-	-	10	12	14	10	14	14	8	9	11
680	-	-	-	-	-	-	-	-	-	10	14	16	10	14	16	8	10	11
750	-	-	-	-	-	-	-	-	-	12	16	16	12	16	16	8	10	11
820	-	-	-	-	-	-	-	-	-	12	16	16	12	16	16	8	10	11
1000	-	-	-	-	-	-	-	-	-	14	16	18	14	16	18	10	12	13

NIC RESERVES THE RIGHT TO REQUEST MINIMUM QUANTITIES ON CERTAIN VALUES



Ceramic Disc Capacitors

Taping Specifications

DIMENSIONS (mm)

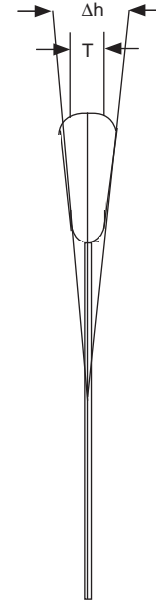
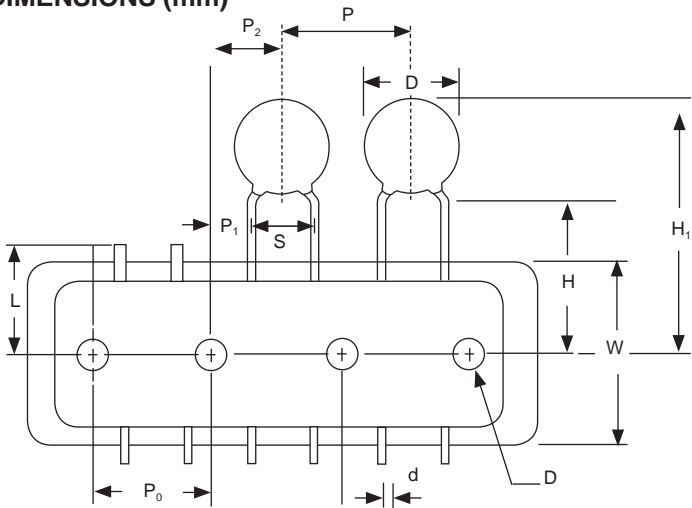

Diameters up to 22mm max. are available on tape.

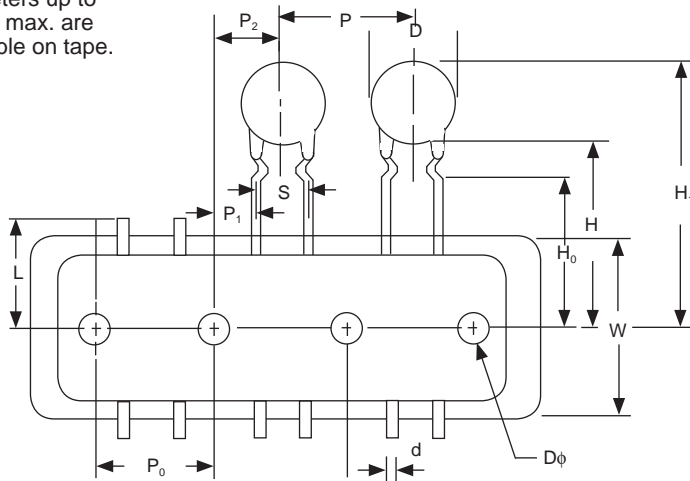

T = 2 ~ 7mm DEPENDENT ON T.C. AND CV

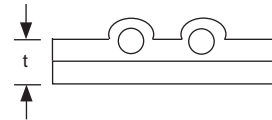

Symbol	D max.	d	P*	P ₀	P ₁	P ₂	S	H	H ₀	H ₁	Dφ	W	L	t	Δh
Value	12.0 22.0	0.6	12.7 25.4	12.7	5.1 3.85 3.18 2.6	6.35	2.5 5.0 6.35 7.5	20.0	16.0	Max. 32.25	4.0	18.0	Max. 11.00	0.7	0
Tolerance	---	+0.06 -0.05	±1.0	±0.2	±0.7	±1.0	±0.8 -0.2	+1.5 -1.0	±0.5	---	±0.2	±0.5	---	±0.2	±2.0

* -Dimension "P" is 12.7mm, for diameters up to 12mm, and 25.4mm for diameters 13-22mm.

AMMO PACK

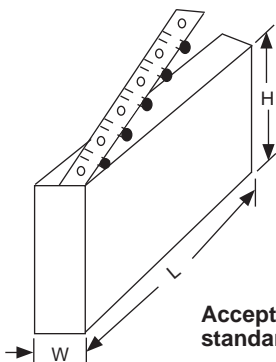

H ≤ 372 (14.64")
L ≤ 377 (14.84")
W ≤ 55 (2.16")

Acceptable to standard radial type cartridge.

REEL

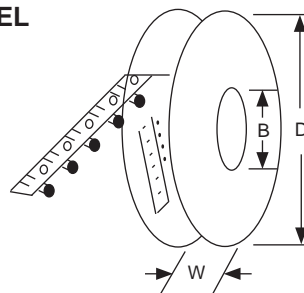

D ≤ 354 (13.93")
B ≥ 21 (.83") but
≤ 30 (1.18")
W ≤ 55 (2.16")

Acceptable to standard radial type cartridge with a few extra accessories.

