

Declaration of Conformity

We, Manufacturer

ZIPPY TECHNOLOGY CORP.
10F, No.50, MIN MINQUAN RD.
XINDIAN DIST, NEW TAIPEI CITY
TAIWAN, R.O.C.

declare that the product
(description of the apparatus, system, installation to which it refers)

SWITCHING POWER SUPPLY KIN-2800K2

is in conformity with
(reference to the specification under which conformity is declared)
in accordance with 2014/30/EU-EMC Directive

- | | |
|-----------------------------------------------------------------------------------------------------------------------------------|-----------------------------------------------------------------------------------------------------------------------------|
| ■ EN 55022 : 2010 Information technology equipment -Radio disturbance characteristics -Limits and methods of measurement | ■ EN 61000-4-5 : 2014 Criteria B Surge Immunity requirements |
| ■ EN 55024 : 2010 Information technology equipment -Immunity characteristics -Limits and methods of measurement | ■ EN 61000-4-6 : 2014 Criteria A Conducted Immunity |
| ■ EN 61000-4-2 : 2009 Criteria B Electrostatic discharge requirements "ESD" | ■ EN 61000-4-8 : 2010 Criteria A Power Frequency Magnetic Field Immunity |
| ■ EN 61000-4-3 : 2006+A1:2008+A2:2010 Criteria A Radiated, radio frequency electromagnetic field | ■ EN 61000-4-11 : 2004 Dip Criteria B Interruptions Criteria C Voltage Dip, interruptions Immunity requirements |
| ■ EN 61000-4-4 : 2012 Criteria B Electrical fast transient requirements "EFT" | ■ EN 61000-3-2 : 2014 Harmonic current requirements |
| | ■ EN 61000-3-3 : 2013 Voltage fluctuations and flicker requirements |

Checked by : Karen
(Karen Ma / Engineer)

, Date : DEC,15,2016

Approved by : Jeff Huang
(Jeff Huang / Director)

, Date : DEC,15,2016

APPLICATION FOR CERTIFICATION
ON Behalf Of
ZIPPY TECHNOLOGY CORP.
SWITCHING POWER SUPPLY

Model# : **KIN-2800K2**

PREPARED FOR :

ZIPPY TECHNOLOGY CORP.
10F., No.50, MINQUAN RD.,
XINDIAN DIST., NEW TAIPEI CITY
TAIWAN, R.O.C

REPORT BY :

ZIPPY TECHNOLOGY CORP.
10F., No.50, MINQUAN RD.,
XINDIAN DIST., NEW TAIPEI CITY
TAIWAN, R.O.C
TEL : (02)2918-8512
FAX : (02)2913-4969

TABLE OF CONTENTS

| Description | Page |
|--------------------------------------------------------------------|------|
| 1. Test Report Certification | 5 |
| 2. General Information | 6 |
| 2.1 Production Description..... | 6 |
| 2.2 Tested System Details..... | 7 |
| 2.2.1 Resistor Load..... | 7 |
| 2.3 Test Methodology..... | 7 |
| 2.4 Test Facility..... | 7 |
| 3. Electronic-Magnetic Interference Test | 8 |
| 3.1. Conducted Power Line Test..... | 8 |
| 3.1.1 Test Equipments..... | 8 |
| 3.1.2 Block Diagram of Test Setup..... | 8 |
| 3.1.3 Conducted Powerline Emission Limit..... | 9 |
| 3.1.4 EUT Configuration on Measurement..... | 9 |
| 3.1.5 EUT Exercise Software..... | 9 |
| 3.1.6 Conducted Emission Data..... | 9 |
| 3.2. Radiation Emission Test | 12 |
| 3.2.1 Test Equipment | 12 |
| 3.2.2 Test Setup | 12 |
| 3.2.3 Radiated Emission Limited | 13 |
| 3.2.4 EUT Configuration | 14 |
| 3.2.5 Operating Condition of EUT | 14 |
| 3.2.6 Radiated Emission Data | 14 |
| 3.2.7 Test Photo and Setup | 18 |
| 4. ESD Measurement | 19 |
| 4.1 Test Equipments..... | 19 |
| 4.2 Test Setup..... | 19 |
| 4.2.1 Block Diagram of Connections between EUT and simulators..... | 19 |
| 4.2.2 Test Setup of EUT..... | 19 |
| 4.3 Severity Levels..... | 20 |
| 4.4 EUT Operating Condition..... | 20 |
| 4.5 Test Procedure..... | 20 |
| 4.6 Test Method..... | 20 |
| 4.7 Test Result..... | 21 |

TABLE OF CONTENTS

| Description | Page |
|---------------------------------------------------------------------|------|
| 5. Radiated Susceptibility Measurement | 22 |
| 5.1 Test Equipment..... | 22 |
| 5.2 Block Diagram of Test Setup..... | 22 |
| 5.3 Severity Levels..... | 23 |
| 5.4 EUT Operating Condition..... | 23 |
| 5.5 Test procedure..... | 23 |
| 5.6 Test Method..... | 23 |
| 5.7 Test Result..... | 24 |
| 6. Electrical Fast Transient/Burst Measurement | 25 |
| 6.1 Test Equipment | 25 |
| 6.2 Block Diagram of Test Setup..... | 25 |
| 6.3 Severity Levels | 25 |
| 6.4 EUT Operating Condition..... | 26 |
| 6.5 Test procedure | 26 |
| 6.6 Test Method..... | 26 |
| 6.7 Test Result..... | 27 |
| 7. Harmonic Current Requirements | 28 |
| 8. Voltage Fluctuation and Filcker Test | 30 |
| 9. Surge Immunity Test | 31 |
| 10. Conducted Immunity Test | 32 |
| 11. Voltage Dip,interruptions Immunity Test | 33 |
| 12. Power Frequency Magnetic Field (PFM) Immunity Test | 34 |
| 13. Photographs | 35 |
| 14. EMI Reduction method during compliance Testing | 39 |

1. Test Report Certification

Applicant : ZIPPY TECHNOLOGY CORP.

Manufacturer : ZIPPY TECHNOLOGY CORP.

EUT Description : Switching Power Supply

(A) Model No. : KIN-2800K2

(B) Serial No. : N/A

(C) Power Supply : 115Vac/60Hz,230Vac/50Hz

MEASUREMENT PROCEDURE USED :

EN 55024 RULES

EN 55022 RULES

THE DEVICE DESCRIBED ABOVE WAS TESTED BY ZIPPY SHIN JIUH CORP. TO DETERMINE THE SEVERITY LEVELS THE DEVICE CAN ENDURE AND ITS PERFORMANCE CRITERION.

THE MEASUREMENT RESULTS ARE CONTAINED IN THIS TEST REPORT AND ZIPPY SHIN JIUH CORP. IS ASSUMED FULL RESPONSIBILITY FOR THE ACCURACY AND COMPLETENESS OF THESE MEASUREMENT.

ALSO, THIS REPORT SHOWS THAT THE EUT TO BE TECHNICALLY COMPLIANT WITH THE EN STANDARD.

2. General Information

2.1 Production Description

Description : Switching Power Supply

Model Number : **KIN-2800K2**

Applicant : ZIPPY TECHNOLOGY CORP.

Address : 10F., No.50, MINQUAN RD.,XINDIAN DIST.,
NEW TAIPEI CITY TAIWAN, R.O.C

Data Cable : N/A

PowerCord : Non-Shielded, detachable, 1.5m

2.2 Tested System Details

The FCC IDs for all equipment, plus descriptions of all cables used in the tested system (including inserted cards, which have grants) are:

2.2.1 Resistor Load

Model Number : ELECTRONIC LOAD
Serial Number : N/A
Manufacturer : ZIPPY
Power : 800W

2.3 Test Methodology

EMI Test:

Both conducted and radiated testing were performed according to the procedures in EN 55022
Radiated testing was performed at an antenna to EUT distance of 10 meters.

EMS Test:

Performed according to procedures in EN 61000 series regulations.

2.4 Test Facility

ZIPPY TECHNOLOGY CORP.
10F., No.50, MINQUAN RD.,
XINDIAN DIST., NEW TAIPEI CITY
TAIWAN, R.O.C

3. Electronic-Magnetic Interference Test

3.1 Conducted Power Line Test

3.1.1 TEST Equipment's

The following test equipment's are used during the conducted power line tests:

| Item | Instrument | Manufacture | Type No: | Last Calibration |
|------|----------------------------|-----------------|----------|------------------|
| 1 | TEST RECEIVER | ROHDE & SCHWARZ | ESL | Mar.,2016 |
| 2 | LISN | ROHDE & SCHWARZ | ENV4200 | Dec.,2016 |
| | | ROHDE & SCHWARZ | ENV216 | Apr.,2016 |
| 3 | SHIELDED ROOM 4.0M*3.0M*3M | | | N/A |

3.1.2 Block Diagram of Test Setup

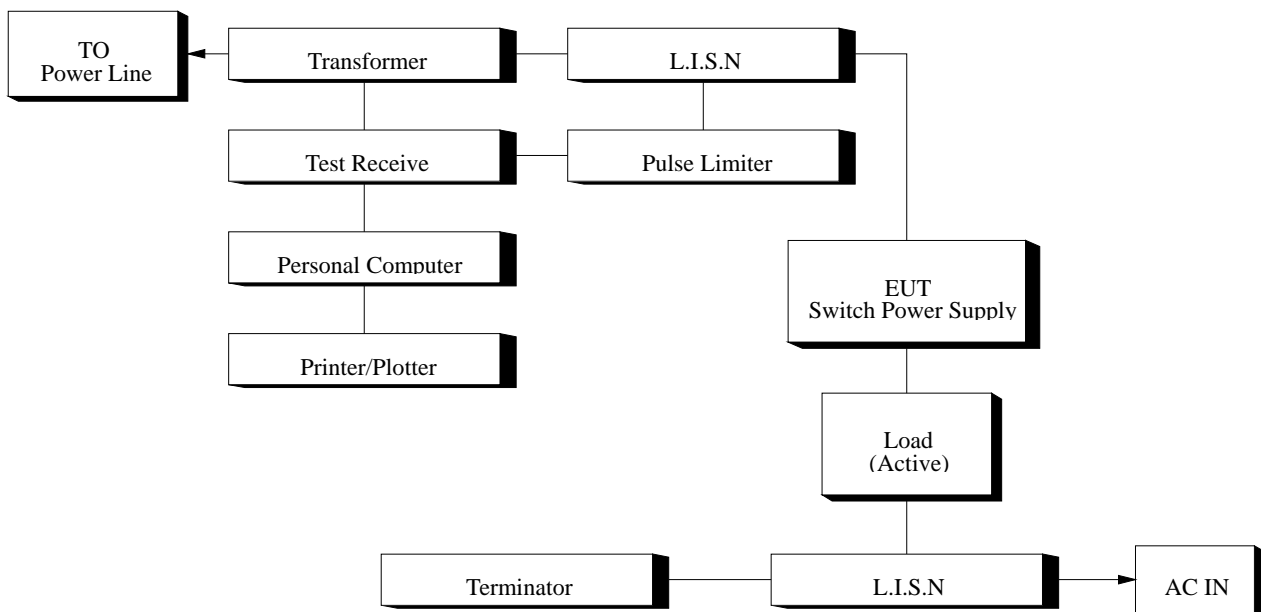

3.1.3 Conducted Powerline Emission Limit

| Maximum RF Line Voltage dB(uV) | | |
|--------------------------------|------------|---------|
| Frequency | Class B | |
| MHz | QUASI-PEAK | AVERAGE |
| 0.15 - 0.50 | 66-56 | 66-56 |
| 0.50 - 5.0 | 56 | 56 |
| 5.0 - 30 | 60 | 60 |

Remarks : In the Above Table, the tighter limit applies at the band edges.

3.1.4 EUT Configuration on Measurement

The equipment's which is listed 3.2 are installed on Conducted Power Line Test to meet the Commission requirement and operating in a manner which tends to maximize its emission characteristics in a normal application.

3.1.5 EUT Exercise Software

The EUT exercise program used during conducted testing was designed to exercise the EUT in a manner similar to a typical use. The exercise sequence is listed as below :

3.1.5.1 Setup the EUT and simulators as shown on 3.2.

3.1.5.2 Turn on the power of all equipment's.

3.1.6 Conducted Emission Data

The measurement range of conducted emission which is from 0.15 MHz to 30 MHz was investigated. The initial step in collecting conducted data is a spectrum analyzer peak scan of the measurement range for all the test modes. Then the worst modes were reported the following data pages.

Conducted Emission Data (LINE)

EUT : SWITCH POWER SUPPLY TEMP. / HUMIDITY : 26°C / 65%

TEST MODE : KIN-2800K2 TEST SPEC. : CISPR22 CLASS-B

LOAD : 65.5 3.5 MODE : LINE-220V

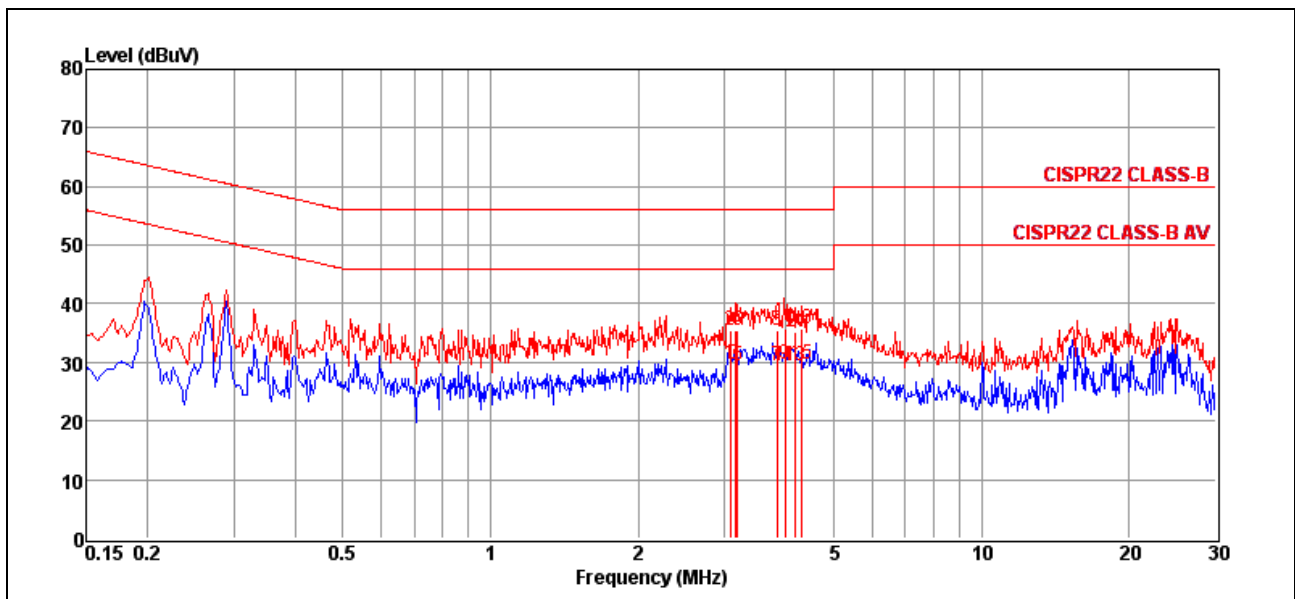

| Freq | Reading | Reading | Factor | Result | Result | Limit | Limit | Margin | Margin |
|------|---------|---------|--------|--------|--------|-------|-------|--------|--------|
| | QP | AV | | QP | AV | QP | AV | QP | AV |
| MHz | dBuV | dBuV | dB | dBuV | dBuV | dBuV | dBuV | dB | dB |
| 3.08 | | 9.56 | 20.18 | | 29.74 | | 46.00 | | 16.26 |
| 3.08 | 15.39 | | 20.18 | 35.57 | | 56.00 | | 20.43 | |
| 3.15 | | 9.48 | 20.29 | | 29.77 | | 46.00 | | 16.23 |
| 3.15 | 15.27 | | 20.29 | 35.56 | | 56.00 | | 20.44 | |
| 3.19 | | 9.18 | 20.36 | | 29.54 | | 46.00 | | 16.46 |
| 3.19 | 15.16 | | 20.36 | 35.52 | | 56.00 | | 20.48 | |
| 3.84 | | 7.96 | 21.58 | | 29.54 | | 46.00 | | 16.46 |
| 3.84 | 13.99 | | 21.58 | 35.57 | | 56.00 | | 20.43 | |
| 3.97 | | 7.80 | 21.81 | | 29.61 | | 46.00 | | 16.39 |
| 3.97 | 13.95 | | 21.81 | 35.76 | | 56.00 | | 20.24 | |
| 4.00 | | 7.44 | 21.85 | | 29.29 | | 46.00 | | 16.71 |
| 4.00 | 13.41 | | 21.85 | 35.26 | | 56.00 | | 20.74 | |
| 4.17 | | 7.43 | 21.94 | | 29.37 | | 46.00 | | 16.63 |
| 4.17 | 13.22 | | 21.94 | 35.16 | | 56.00 | | 20.84 | |
| 4.31 | | 7.88 | 21.85 | | 29.73 | | 46.00 | | 16.27 |
| 4.31 | 13.80 | | 21.85 | 35.65 | | 56.00 | | 20.35 | |

Conducted Emission Data (NEUTRAL)

EUT : SWITCH POWER SUPPLY TEMP. / HUMIDITY : 26°C / 65%

TEST MODE : KIN-2800K2 TEST SPEC. : CISPR22 CLASS-B

LOAD : 65.5 3.5 MODE : NEUTRAL-220V

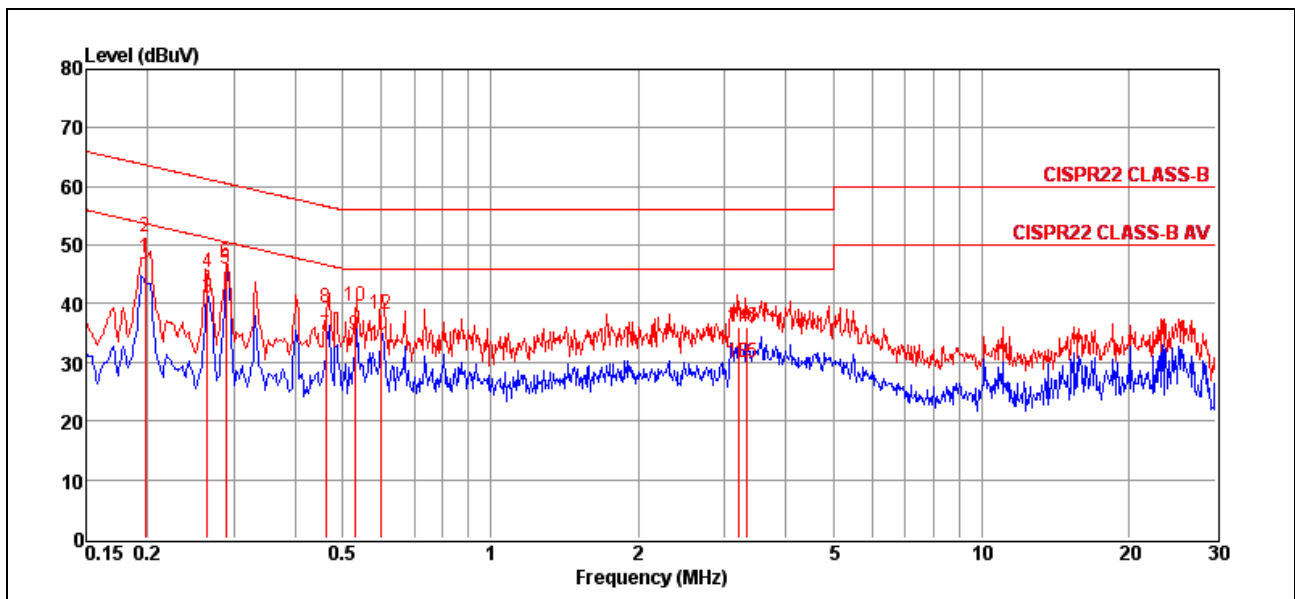

| Freq | Reading | Reading | Factor | Result | Result | Limit | Limit | Margin | Margin |
|------|---------|---------|--------|--------|--------|-------|-------|--------|--------|
| | QP | AV | | QP | AV | QP | AV | QP | AV |
| MHz | dBuV | dBuV | dB | dBuV | dBuV | dBuV | dBuV | dB | dB |
| 0.20 | | 25.00 | 22.76 | | 47.76 | | 53.70 | | 5.94 |
| 0.20 | 28.72 | | 22.76 | 51.48 | | 63.70 | | 12.22 | |
| 0.27 | | 19.30 | 21.72 | | 41.02 | | 51.26 | | 10.24 |
| 0.27 | 23.67 | | 21.72 | 45.39 | | 61.26 | | 15.87 | |
| 0.29 | | 24.48 | 21.41 | | 45.89 | | 50.54 | | 4.65 |
| 0.29 | 25.64 | | 21.41 | 47.05 | | 60.54 | | 13.49 | |
| 0.46 | | 12.94 | 21.82 | | 34.76 | | 46.66 | | 11.90 |
| 0.46 | 17.61 | | 21.82 | 39.43 | | 56.66 | | 17.23 | |
| 0.53 | | 11.78 | 22.76 | | 34.54 | | 46.00 | | 11.46 |
| 0.53 | 16.87 | | 22.76 | 39.63 | | 56.00 | | 16.37 | |
| 0.60 | | 9.63 | 23.47 | | 33.10 | | 46.00 | | 12.90 |
| 0.60 | 14.65 | | 23.47 | 38.12 | | 56.00 | | 17.88 | |
| 3.20 | | 8.95 | 21.15 | | 30.10 | | 46.00 | | 15.90 |
| 3.20 | 14.98 | | 21.15 | 36.13 | | 56.00 | | 19.87 | |
| 3.32 | | 8.66 | 21.20 | | 29.86 | | 46.00 | | 16.14 |
| 3.32 | 14.74 | | 21.20 | 35.94 | | 56.00 | | 20.06 | |

3.2 Radiation Emission Test

3.2.1 Test Equipment

The following test equipment's are used during the radiated emission test :

| Instrument | Manufacture | Type No: | Last Calibration |
|-------------------|-------------|----------|------------------|
| Spectrum Analyzer | H.P | 8594A | May.,2016 |
| Test Receiver | IFR System | A-7550 | Jun.,2016 |
| Preamplifier | H.P | 8447D | May.,2016 |
| Biconical Ant. | Emco | 3110 | Jun.,2016 |
| Log-Periodic Ant. | Emco | 3146 | Jun.,2016 |
| Dipole Antenna | Emco | 3121C | May.,2016 |

3.2.2 Test Setup

3.2.2.1 Block Diagram of Connection between EUT and simulators

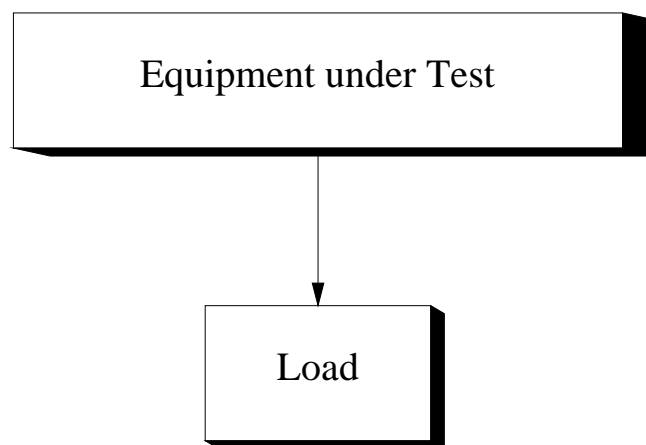

EUT: SWITCHING POWER SUPPLY

3.2.2.2 Open Field Test Site - description

The open field test site (OFTS) is designed to provide an environment in which repeatable tests of radiated emissions can be carried out.

It consists of a flat elliptical area as shown in the diagram below.

The equipment under test and the antenna are placed at the foci of the ellipse.

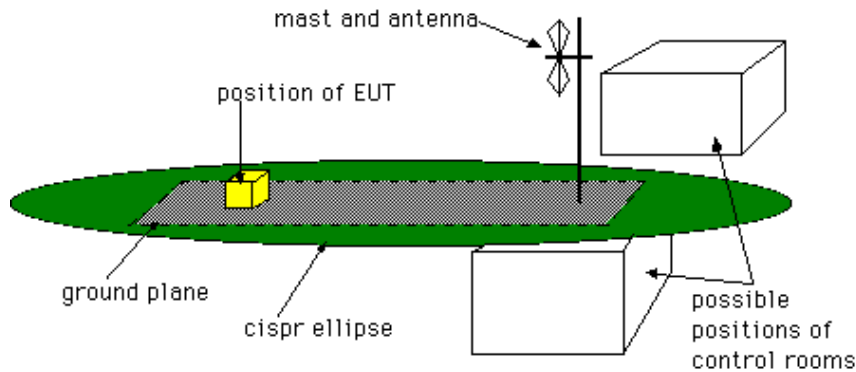

The antenna height should be remotely adjustable from 1m to 4m. Measuring instrumentation should be outside the ellipse at the position shown or in a room under the ground plane.

The whole or part of the site may be enclosed in an RF transparent building.

For precompliance testing a 3m test site with a fixed height antenna (at 1.5-2m height) and no metallic ground plane may be used. This may be a clear area on a car park or a grass area but should be away from large metallic structures.

3.2.3 Radiated Emission Limit

Class B Limits

| Frequency | Distance | Field Strength |
|-----------|----------|----------------|
| MHz | Meter | DB(uV/M) |
| 30-230 | 10 | 30 |
| 230-1000 | 10 | 37 |

Remarks :

1. The tighter limit shall apply at the edge between two frequency bands.
2. Distance refers to the distance in meters between the measuring instrument antenna and the closed point of any part of the device or system.

3.2.4 EUT Configuration

The equipment's which is listed 4.2.1 are installed on Radiated Emission Test to meet the Commission requirement and operating in a manner which tends to maximize its emission characteristics in a normal application.

3.2.5 Operation Condition of EUT

Same as Conducted Power Line Test which is listed in 3.1.5 .

3.2.6 Radiated Emission Data

The measurement range of radiated emission which is from 30 MHz to 1000 MHz was investigated. The initial step in collecting conducted data is a spectrum analyzer peak scan of the measurement range for all the test modes. Then the worst modes were reported the following data pages.

Radiated Emission Data

EUT : SWITCH POWER SUPPLY TEMPERATURE : 26°C

TEST MODE : KIN-2800K2 HUMIDITY : 57%

| Frequency (MHz) | Emission Level | Limits dBuV/m | Remark |
|--------------------|----------------------|------------------|--------|
| | Horizontal dBuV/m | | |
| 203.63 | 24.77 | 30.00 | |
| 363.68 | 15.33 | 37.00 | |
| 570.29 | 18.98 | 37.00 | |
| | | | |
| | | | |
| | | | |
| | | | |
| | | | |
| | | | |
| | | | |
| | | | |
| | | | |
| | | | |
| | | | |
| | | | |
| | | | |
| | | | |
| | | | |

Radiated Emission Data

EUT : SWITCH POWER SUPPLY TEMPERATURE : 26°C

TEST MODE : KIN-2800K2 HUMIDITY : 57%

| Frequency (MHz) | Emission Level | Limits dBuV/m | Remark |
|--------------------|--------------------|------------------|------------|
| | Vertical dBuV/m | | |
| 203.63 | 24.73 | 30.00 | Quasi-Peak |
| 372.41 | 23.32 | 37.00 | |
| 580.96 | 19.20 | 37.00 | |
| 651.77 | 19.25 | 37.00 | |
| 749.74 | 22.42 | 37.00 | |
| | | | |
| | | | |
| | | | |
| | | | |
| | | | |
| | | | |
| | | | |
| | | | |
| | | | |
| | | | |
| | | | |
| | | | |
| | | | |

Horizontal Curve

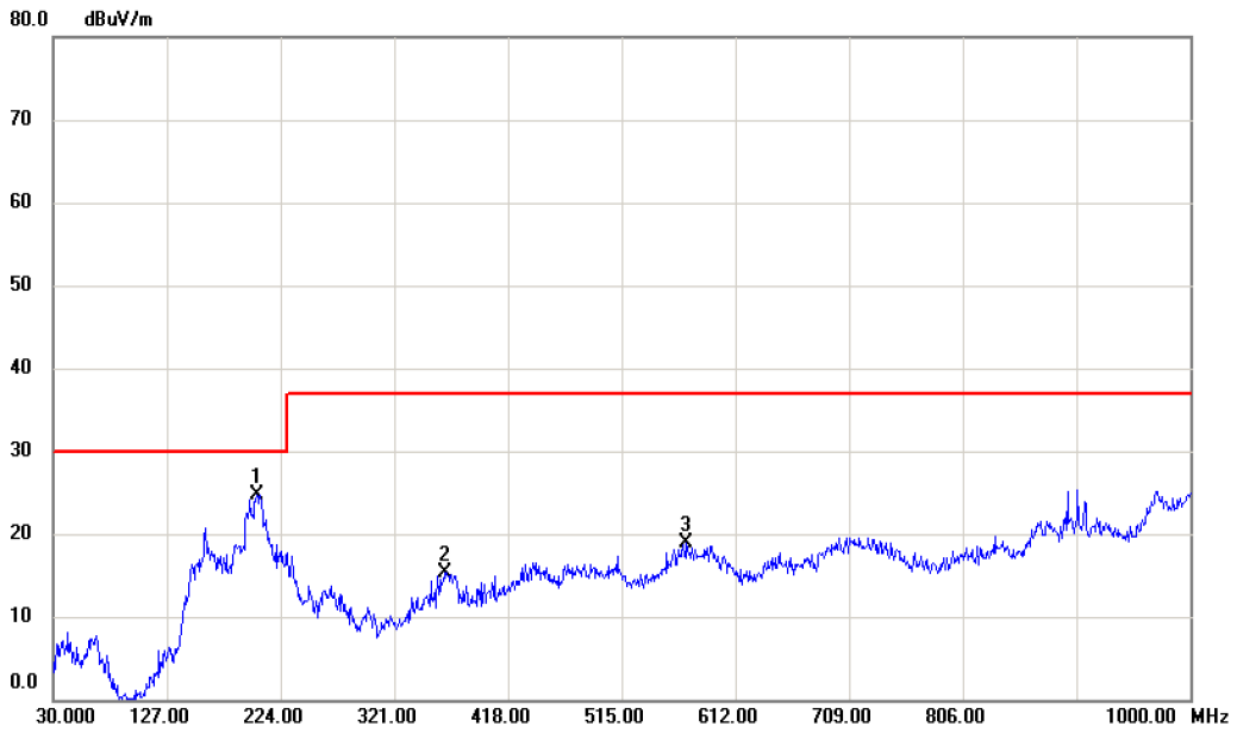

Vertical Curve

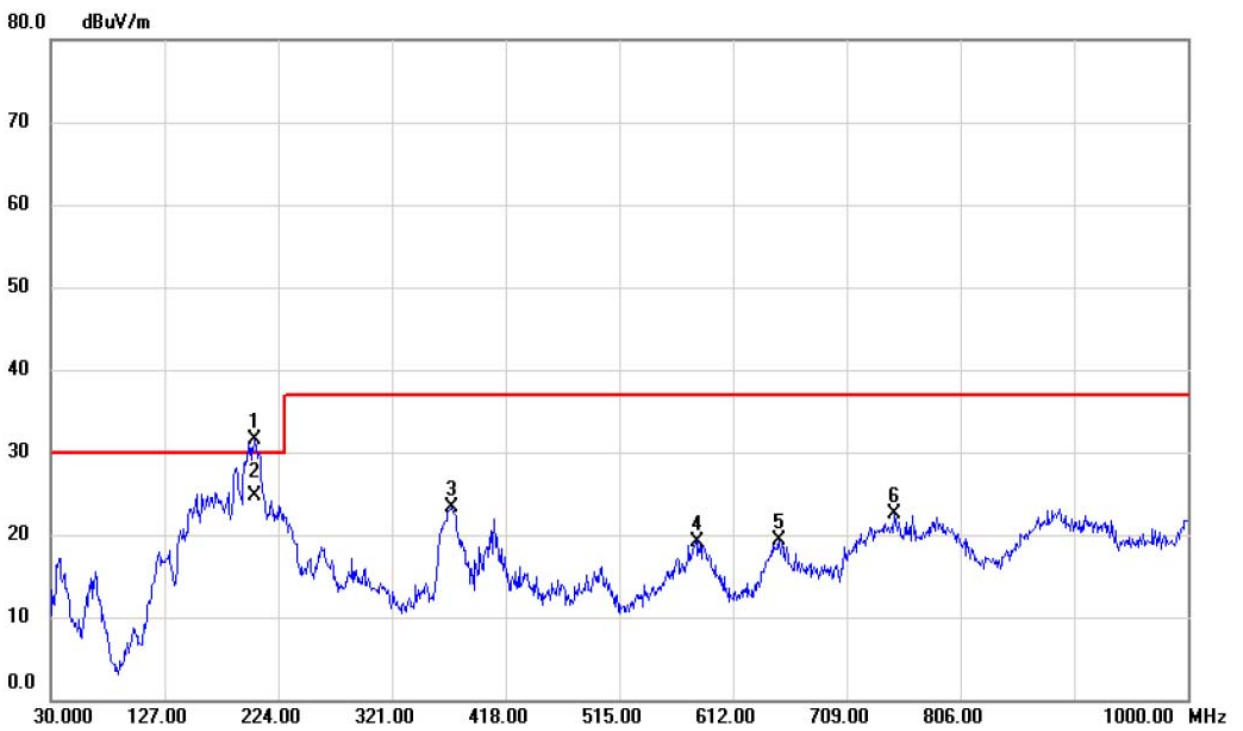

3.2.7 Test Photo and Setup

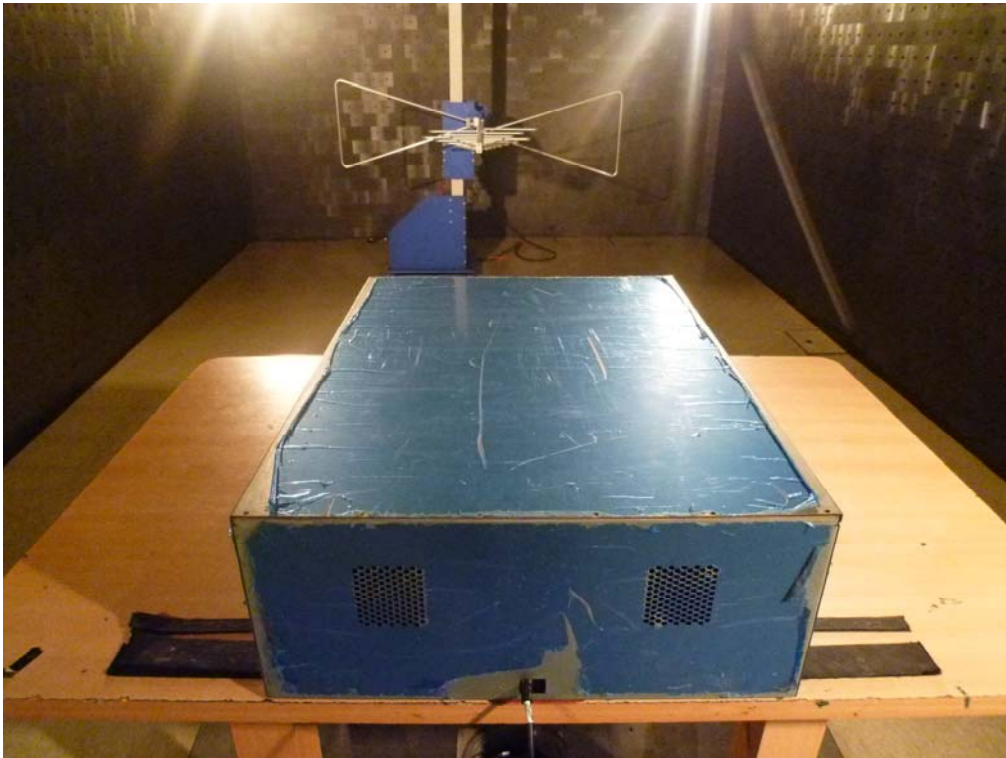

※During the radiated test, the power-supply has to test with chassis, which is not allowed to be operated stand-alone. (For user, final assembly has to comply with corresponding EMC-and safety-regulations.)

4. ESD Measurement

4.1 Test Equipment

The following test equipment's are used during the ESD test :

| Instrument | Manufacture | Type No: | Last Calibration |
|----------------------|-------------|-----------|------------------|
| ESD Simulator system | Keytek | MZ-15/EC | May.,2016 |
| Electronic Load | D-RAM | Load-2000 | N/A |

4.2 Test Setup

4.2.1 Block Diagram of Connections between EUT and simulators

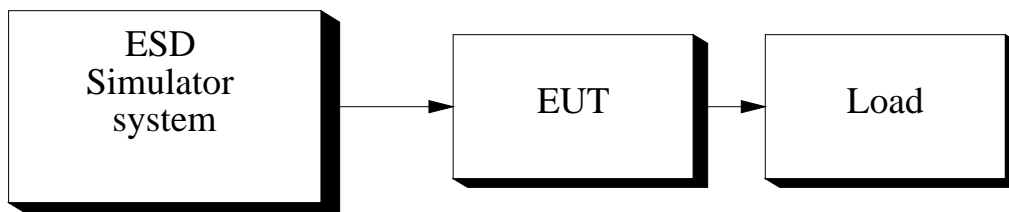

4.2.2 Test Setup of EUT

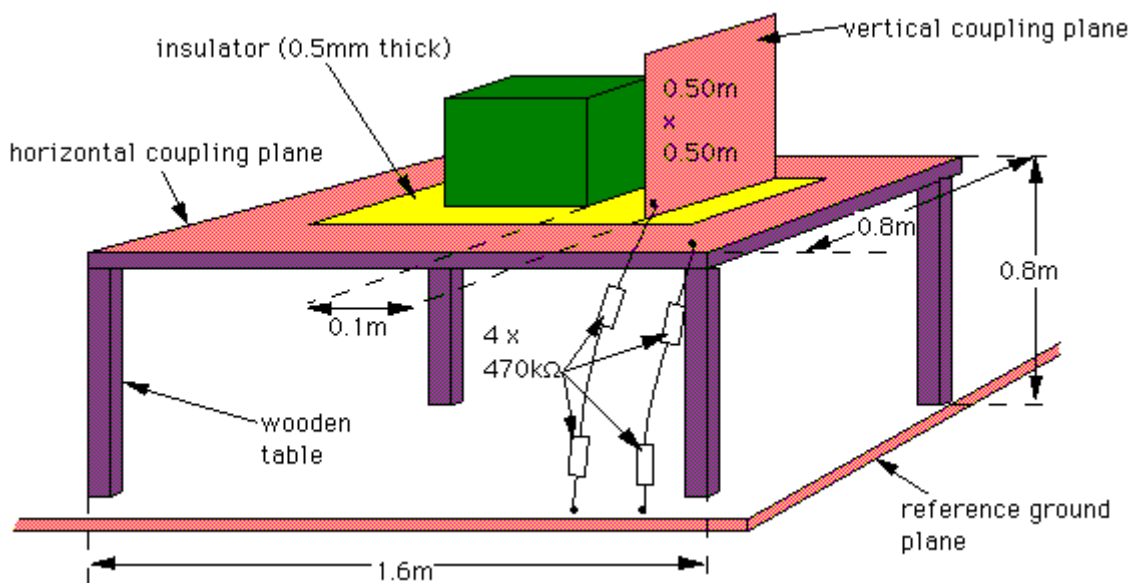

4.3 Severity Levels

| LEVEL | TEST VOLTAGE CONTACT DISCHARGE | TEST VOLTAGE AIR DISCHARGE |
|-------|--------------------------------|----------------------------|
| 1 | 2KV | 2KV |
| 2 | 4KV | 4KV |
| 3 | 6KV | 6KV |
| 4 | 8KV | 8KV |
| X | SPECIAL | SPECIAL |

4.4 EUT Operating Condition

1. Setup the EUT and Test Equipment as shown on 4.2
2. power on.

4.5 Test Procedure

Air Discharge:

This test was done above a non-conductive surfaces. The round discharge electrode about 30cm away will approach as fast as possible to touch test points of the EUT.

Discharge happens before the contact. This procedure is repeated ten times on one selected location.

4.6 Test Method

According to IEC 61000-4-2

4.7 Test Result

EUT : SWITCH POWER SUPPLY TEMPERATURE : 26°CTEST MODE : KIN-2800K2 HUMIDITY : 65%

| Item | Amount of discharge | Voltage | Results |
|-------------------|---------------------|--------------|--------------|
| Contact discharge | 500 | +2KV -2KV | Pass Pass |
| Contact discharge | 500 | +4KV -4KV | Pass Pass |
| Air discharge | 500 | +2KV -2KV | Pass Pass |
| Air discharge | 500 | +4KV -4KV | Pass Pass |
| Air discharge | 500 | +6KV -6KV | Pass Pass |
| Air discharge | 500 | +8KV -8KV | Pass Pass |

※Input Voltage / Frequency : 230Vac/50Hz

5. Radiated Susceptibility Measurement

5.1 Test Equipment

The following test equipment's are used during the RS test :

| Instrument | Manufacture | Type No: | Last Calibration |
|-----------------------|-------------|----------|------------------|
| Signal generator | H.P | 8657A | Dec.,2016 |
| Power amplifier | A&R | 100A100 | Dec.,2016 |
| Field strength meter | A&R | FM2000 | Oct.,2016 |
| Field strength sensor | A&R | EP2000 | Oct.,2016 |
| Power antenna | A&R | AT1080 | Oct.,2016 |

5.2 Block Diagram of Test Setup

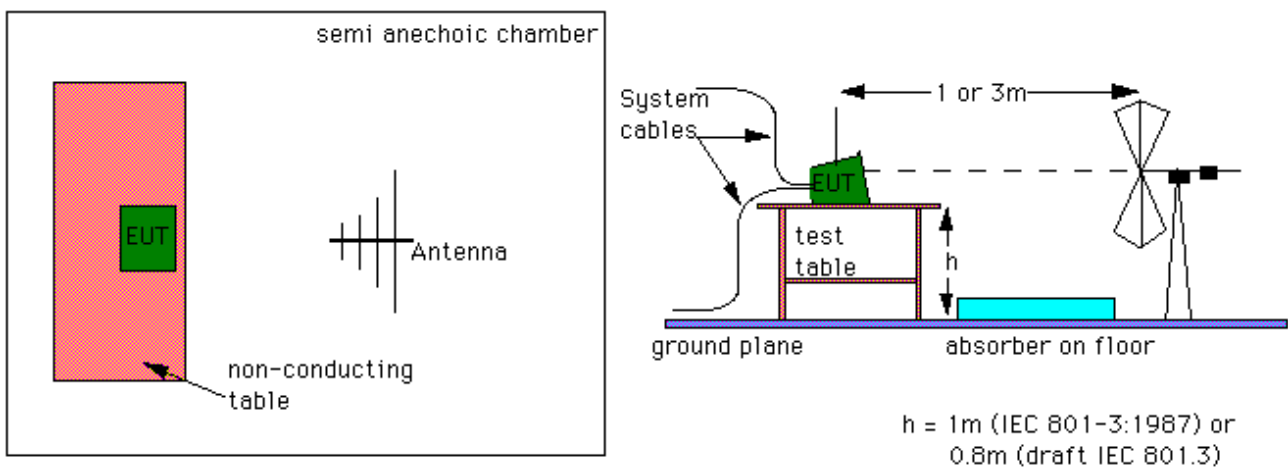

Antennas-layout

For the upper frequency range of 200 to 1000 MHz, antennas are the normal method of producing the required field strength. This is also carried out in an anechoic chamber or a screened room. If a screened room is used it must be damped. The anechoic chamber should be used for compliance testing, the screened room may be used for precompliance testing. The fields in the screened room will not be as uniform as those obtainable in an anechoic chamber and will also not be as repeatable. The EUT is placed on a non-conductive table, 0.8 m above the reference ground plane, which in many cases will be the floor of a screened room. According to the standards, the EUT should be oriented so that its most sensitive side is facing the antenna. In practice it can be difficult to decide beforehand which is the most sensitive side, and in most cases, a series of tests will be required with the EUT in several orientations.

5.3 Severity Levels

| LEVEL | FIELD STRENGTH V/M |
|-------|--------------------|
| 1 | 1 |
| 2 | 3 |
| 3 | 10 |
| X | SPECIAL |

5.4 EUT Operating Condition

Same as section 4.4.

5.5 Test Procedure

The EUT and load are placed on a table which is 0.8 meter above ground. The field sensor is also placed on the same table to monitor field strength from transmitting antenna.

EUT is set 1 meter away from the transmitting antenna which is mounted on an antenna each time.

The antenna is fixed 1 meter above ground. Both horizontal and vertical polarization of the antenna are set on measurement. In order to judge the EUT performance, a CCD camera is used to monitor EUT screen.

All the scanning conditions are as follows :

| Condition of Test | Remarks |
|---------------------------|------------------------------------------|
| 1. Field Strength | 3 V/M Level 2 |
| 2. Radiated Signal | 80% Amplitude Modulated with a 1KHz Tone |
| 3. Scanning Frequency | 80 MHz-1 GHz |
| 4. Sweep Time of Radiated | 0.0015 Decade/s |

5.6 Test Method

According to IEC 61000-4-3

5.7 Test Result

EUT : SWITCH POWER SUPPLY TEMPERATURE : 26°C
 TEST MODE : KIN-2800K2 HUMIDITY : 65%

| Frequency Range (MHz) | Position (Angle) | Polarity (HorV) | Field Strength (V/M) | Results |
|-----------------------|------------------|-----------------|----------------------|---------|
| 80-1000 | 0° (Front) | H | 3 | Pass |
| 80-1000 | 90° (Right) | H | 3 | Pass |
| 80-1000 | 180° (Back) | H | 3 | Pass |
| 80-1000 | 270° (Left) | H | 3 | Pass |
| 80-1000 | 0° (Front) | V | 3 | Pass |
| 80-1000 | 90° (Right) | V | 3 | Pass |
| 80-1000 | 180° (Back) | V | 3 | Pass |
| 80-1000 | 270° (Left) | V | 3 | Pass |

Test Result : Criteria A

6. Electrical Fast Transient / Burst Measurement

6.1 Test Equipment

The following test equipment's are used during the EFT tests :

| Instrument | Manufacturer | Type No. | Last Calibration |
|---------------------------------|--------------|----------|------------------|
| Fast Transient / Burst enerator | Keytek | EMCpro | May.,2016 |

6.2 Block Diagram of Test Setup

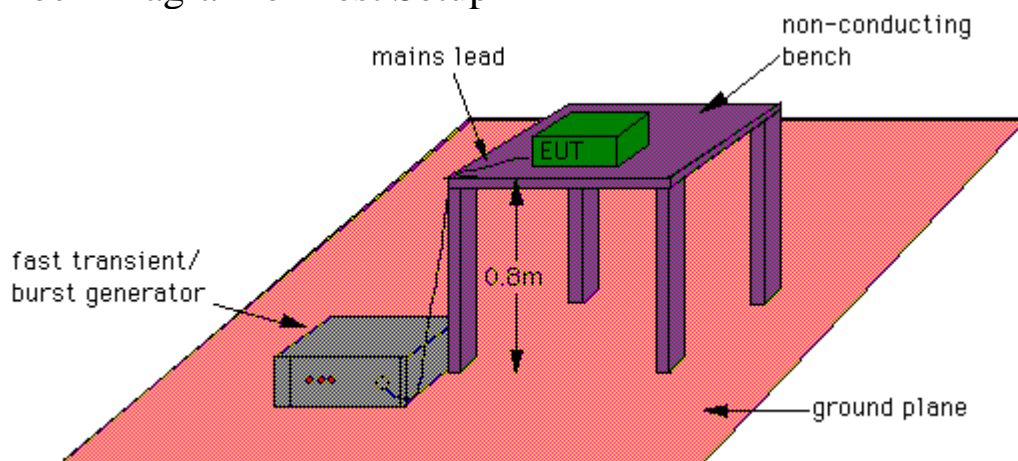

6.3 Severity Levels

| Open Circuit Output Test Voltage $\pm 10\%$ | |
|---------------------------------------------|-----------------------|
| Level | On power supply lines |
| 1 | 0.5KV |
| 2 | 1KV |
| 3 | 2KV |
| 4 | 4KV |
| X | SPECIAL |

6.4 EUT Operation Condition

Same as section 4.4.

6.5 Test Procedure

The EUT and its load are placed on a table which is 0.8 meter above a metal ground plane measured 1m*1m min. And 0.65 mm thick min. And projected beyond the EUT by at least 0.1m on all sides.

The EUT is away from the walls of the test AC power line test is as follows:

For Ac power line test:

The EUT is connected to the power mains through a coupling device that directly couples the EFT interference signal.

Each of the Line and Neutral conductor is impressed with burst noise for 1 min.

6.6 Test Method

According to IEC 61000-4-4.

6.7 Test Result

EUT : SWITCH POWER SUPPLY TEMPERATURE : 26°C

TEST MODE : KIN-2800K2 HUMIDITY : 65%

| Inject Line | Voltage KV | Frequency (KHz) | Inject time (sec) | Inject Method | Result |
|-------------|------------|-----------------|-------------------|---------------|--------|
| L1 | ±1 | 5 | 60 | Direct | Pass |
| L2 | ±1 | 5 | 60 | Direct | Pass |
| PE | ±1 | 5 | 60 | Direct | Pass |
| L1-L2 | ±1 | 5 | 60 | Direct | Pass |
| L1-PE | ±1 | 5 | 60 | Direct | Pass |
| L2-PE | ±1 | 5 | 60 | Direct | Pass |
| L1,L2-PE | ±1 | 5 | 60 | Direct | Pass |

※Input Voltage / Frequency : 230Vac/50Hz

7. Harmonic Current Test

EUT : SWITCH POWER SUPPLY TEMPERATURE : 26°C

TEST MODE : KIN-2800K2 HUMIDITY : 65%

| Item | Reading Leve A | | Item | Reading Leve A | |
|------|----------------|---------|------|----------------|---------|
| | A | Limites | | A | Limites |
| 1 | 3.815 | | | | |
| 3 | 0.515 | 2.300 | | | |
| 5 | 0.098 | 1.140 | | | |
| 7 | 0.028 | 0.770 | | | |
| 9 | 0.023 | 0.400 | | | |
| 11 | 0.011 | 0.305 | | | |
| 13 | 0.021 | 0.210 | | | |
| 15 | 0.035 | 0.150 | | | |
| 17 | 0.033 | 0.132 | | | |
| 19 | 0.018 | 0.118 | | | |
| 21 | 0.007 | 0.107 | | | |
| 23 | 0.006 | 0.098 | | | |
| 25 | 0.009 | 0.090 | | | |
| 27 | 0.012 | 0.083 | | | |
| 29 | 0.011 | 0.078 | | | |
| 31 | 0.008 | 0.073 | | | |
| 33 | 0.004 | 0.068 | | | |
| 35 | 0.004 | 0.064 | | | |
| 37 | 0.003 | 0.061 | | | |
| 39 | 0.002 | 0.058 | | | |



ANALYZER 6630

Current Harmonics

Setup: CLASS_D Gen setting: 1(1) U : 230.19 V fu: 50.001 Hz
 Live Analysed periods: 4 I : 3.852 A P: 0.871 kW
 Module: M1 Limit: Class D (Standard) I1: 3.815 A
 Note:
 THD=13.88 % (PF=0.983) PASSED

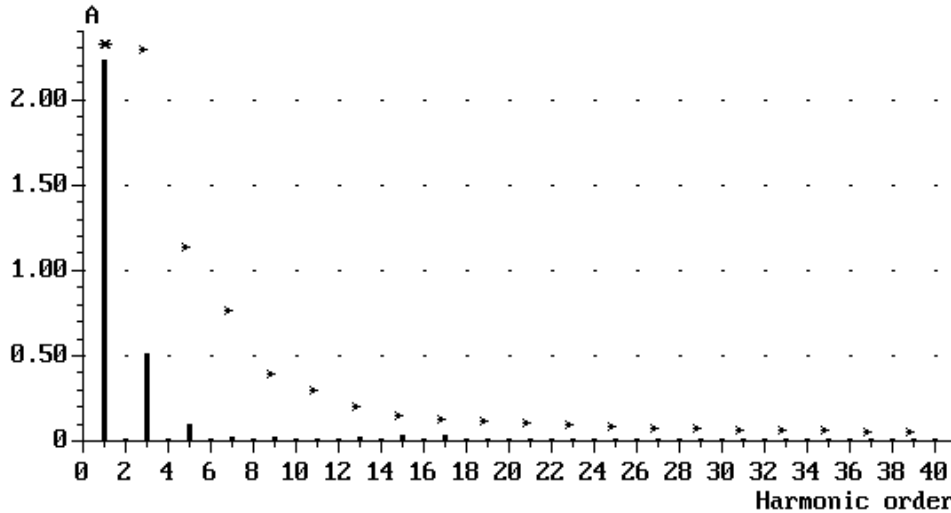

- Next measure

- Change to table

- Relative current

- Log scale

- Write to disk

-

Appl: EUROPE (1212_02)



ANALYZER 6630

Current Harmonics

Setup: CLASS_D Gen setting: 1(1) U : 230.19 V fu: 50.001 Hz
 Live Analysed periods: 4 I : 3.852 A P: 0.871 kW
 Module: M1 Limit: Class D (Standard) I1: 3.815 A
 Note:
 THD=13.88 % (PF=0.983) PASSED

| No | A | Lim A | No | A | Lim A | No | A | Lim A |
|----|-------|-------|----|-------|-------|----|-------|-------|
| 1 | 3.815 | | 15 | 0.035 | 0.150 | 29 | 0.011 | 0.078 |
| 2 | 0.002 | | 16 | 0.002 | | 30 | 0.002 | |
| 3 | 0.515 | 2.300 | 17 | 0.033 | 0.132 | 31 | 0.008 | 0.073 |
| 4 | 0.001 | | 18 | 0.002 | | 32 | 0.001 | |
| 5 | 0.098 | 1.140 | 19 | 0.018 | 0.118 | 33 | 0.004 | 0.068 |
| 6 | 0.001 | | 20 | 0.004 | | 34 | 0.002 | |
| 7 | 0.028 | 0.770 | 21 | 0.007 | 0.107 | 35 | 0.004 | 0.064 |
| 8 | 0.002 | | 22 | 0.002 | | 36 | 0.000 | |
| 9 | 0.023 | 0.400 | 23 | 0.006 | 0.098 | 37 | 0.003 | 0.061 |
| 10 | 0.002 | | 24 | 0.001 | | 38 | 0.001 | |
| 11 | 0.011 | 0.305 | 25 | 0.009 | 0.090 | 39 | 0.002 | 0.058 |
| 12 | 0.003 | | 26 | 0.002 | | 40 | 0.001 | |
| 13 | 0.021 | 0.210 | 27 | 0.012 | 0.083 | | | |
| 14 | 0.005 | | 28 | 0.001 | | | | |

Current range: 10 Ap

- Next measure

- Change to bar graph

- Relative current

- Write to disk

-

Appl: EUROPE (1212_03)

8. Voltage Fluctuation And Flicker Test

EUT : SWITCH POWER SUPPLY TEMPERATURE : 26°C

TEST MODE : KIN-2800K2 HUMIDITY : 65%

| Item | Reading | Limit | Result |
|----------|---------|-------|--------|
| Pst | 0.000 | 1.00 | Pass |
| P1t | 0.000 | 0.65 | Pass |
| Dc (%) | 0.000 | 3.00 | Pass |
| Dmax (%) | 0.000 | 4.00 | Pass |
| Dt (%) | 0.000 | 0.20 | Pass |
| | | | |
| | | | |
| | | | |
| | | | |
| | | | |
| | | | |
| | | | |
| | | | |
| | | | |
| | | | |
| | | | |
| | | | |
| | | | |
| | | | |
| | | | |
| | | | |
| | | | |

9. Surge Immunity Test

EUT : SWITCH POWER SUPPLY TEMPERATURE : 26°C

TEST MODE : KIN-2800K2 HUMIDITY : 65%

| Waveform | Voltage | Output:LC | Phs Ref | Phs Ang | Tests | Delay | Result |
|----------|---------|-------------|---------|----------|-------|--------|--------|
| 12 Ohm | -2000V | MAINS:L1/PE | L1 | 0 deg. | 5 | 60 sec | Pass |
| 12 Ohm | -2000V | MAINS:L1/PE | L1 | 90 deg. | 5 | 60 sec | Pass |
| 12 Ohm | -2000V | MAINS:L1/PE | L1 | 270 deg. | 5 | 60 sec | Pass |
| 12 Ohm | 2000V | MAINS:L1/PE | L1 | 0 deg. | 5 | 60 sec | Pass |
| 12 Ohm | 2000V | MAINS:L1/PE | L1 | 90 deg. | 5 | 60 sec | Pass |
| 12 Ohm | 2000V | MAINS:L1/PE | L1 | 270 deg. | 5 | 60 sec | Pass |
| 12 Ohm | -2000V | MAINS:L2/PE | L1 | 0 deg. | 5 | 60 sec | Pass |
| 12 Ohm | -2000V | MAINS:L2/PE | L1 | 90 deg. | 5 | 60 sec | Pass |
| 12 Ohm | -2000V | MAINS:L2/PE | L1 | 270 deg. | 5 | 60 sec | Pass |
| 12 Ohm | 2000V | MAINS:L2/PE | L1 | 0 deg. | 5 | 60 sec | Pass |
| 12 Ohm | 2000V | MAINS:L2/PE | L1 | 90 deg. | 5 | 60 sec | Pass |
| 12 Ohm | 2000V | MAINS:L2/PE | L1 | 270 deg. | 5 | 60 sec | Pass |
| 2 Ohm | -1000V | MAINS:L1/L2 | L1 | 0 deg. | 5 | 60 sec | Pass |
| 2 Ohm | -1000V | MAINS:L1/L2 | L1 | 90 deg. | 5 | 60 sec | Pass |
| 2 Ohm | -1000V | MAINS:L1/L2 | L1 | 270 deg. | 5 | 60 sec | Pass |
| 2 Ohm | 1000V | MAINS:L1/L2 | L1 | 0 deg. | 5 | 60 sec | Pass |
| 2 Ohm | 1000V | MAINS:L1/L2 | L1 | 90 deg. | 5 | 60 sec | Pass |
| 2 Ohm | 1000V | MAINS:L1/L2 | L1 | 270 deg. | 5 | 60 sec | Pass |

10. Conducted Immunity Test

EUT : SWITCH POWER SUPPLY TEMPERATURE : 26°C

TEST MODE : KIN-2800K2 HUMIDITY : 65%

Test frequency Range : 150kHz ~ 80MHz

Frequency Step : 1% of the momentary frequency

Dwell Time : Minimum 3 sec. per frequency

Modulation : 1kHz Sine Wave with 80% Amplitude Modulation

| Frequency Range (MHz) | Polarity (HorV) | Field Strength (V/M) | Performance | | Result |
|-----------------------|-----------------|----------------------|-------------|-------------|--------|
| | | | Required | Observation | |
| 0.15-80 | H | 3 | A | A | Pass |

11. Voltage Dip, Interruptions Immunity Test

EUT : SWITCH POWER SUPPLY TEMPERATURE : 26°C

TEST MODE : KIN-2800K2 HUMIDITY : 65%

| Test Voltage | Phase Angle | Reduction % | Duration (Periods) | Performance | | Result |
|--------------|-------------|-------------|--------------------|-------------|-------------|--------|
| | | | | Required | Observation | |
| AC 115V | 0 deg. | >95% | 0.5 | B | A | Pass |
| | 90 deg. | | 0.5 | B | A | Pass |
| | 180 deg. | | 0.5 | B | A | Pass |
| | 270 deg. | | 0.5 | B | A | Pass |
| | 0 deg. | 30% | 25 | C | C | Pass |
| | 90 deg. | | 25 | C | C | Pass |
| | 180 deg. | | 25 | C | C | Pass |
| | 270 deg. | | 25 | C | C | Pass |
| | 0 deg. | >95% | 250 | C | C | Pass |
| | 90 deg. | | 250 | C | C | Pass |
| | 180 deg. | | 250 | C | C | Pass |
| | 270 deg. | | 250 | C | C | Pass |
| AC 230V | 0 deg. | >95% | 0.5 | B | A | Pass |
| | 90 deg. | | 0.5 | B | A | Pass |
| | 180 deg. | | 0.5 | B | A | Pass |
| | 270 deg. | | 0.5 | B | A | Pass |
| | 0 deg. | 30% | 25 | C | A | Pass |
| | 90 deg. | | 25 | C | A | Pass |
| | 180 deg. | | 25 | C | A | Pass |
| | 270 deg. | | 25 | C | A | Pass |
| | 0 deg. | >95% | 250 | C | C | Pass |
| | 90 deg. | | 250 | C | C | Pass |
| | 180 deg. | | 250 | C | C | Pass |
| | 270 deg. | | 250 | C | C | Pass |

12. Power Frequency Magnetic Field (PFM) Immunity Test

EUT : SWITCH POWER SUPPLY TEMPERATURE : 26°C

TEST MODE : KIN-2800K2 HUMIDITY : 65%

| Magnetic Field Orientation | Magnetic Field (A/m) | Performance | | Result (Pass/Fail) |
|----------------------------|----------------------|-------------|-------------|--------------------|
| | | Required | Observation | |
| X-axis | 1A | A | A | Pass |
| Y-axis | 1A | A | A | Pass |
| Z-axis | 1A | A | A | Pass |

13. Photographs

1. Front view of Power Supply
2. Back view of Power Supply



3.Component side of Mainboard

4.Solder side of Mainboard

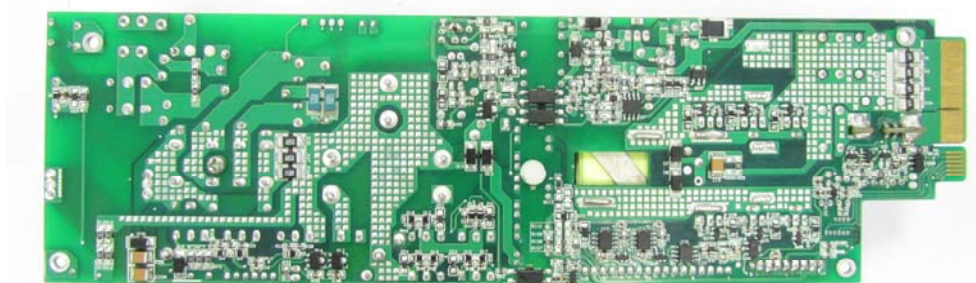
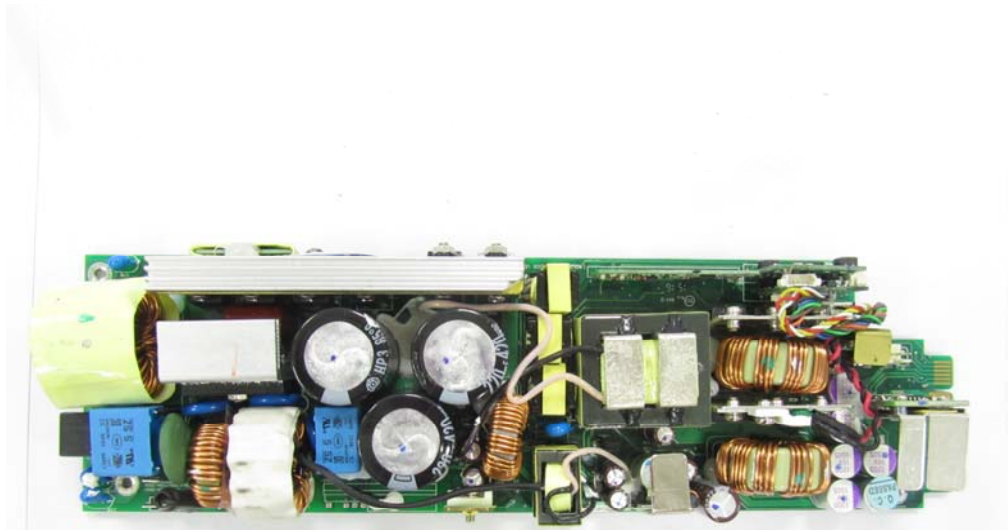

5.Inside view of Power Supply

6.Inside view of Power Supply



7. Test view



14. EMI Reduction Method During Compliance Testing

1.No modification was made during test.