

**Z2PK220H**

● **FEATURES**

- \* Halogen-free type
- \* Compliance to RoHS product
- \* Lead less chip form, no lead damage
- \* Low power loss, High efficiency
- \* High current capability, low VF
- \* Plastic package has Underwriters Laboratory Flammability Classification 94V-0
- \* Patented ZPAK™ Package Technology

● **APPLICATION**

- \* Switching mode power supply applications
- \* Portable equipment battery applications
- \* General rectification
- \* DC / DC Converter
- \* Telecommunication

● **MECHANICAL DATA**

**Case :** Packed with FRP substrate and epoxy underfilled  
**Terminals :** Pure Tin plated (Lead-Free), solderable per MIL-STD-750, Method 2026.  
**Polarity :** Laser Cathode band marking  
**Weight :** 0.012 gram

● **PACKING**

- \* 3,000 pieces per 7" (178mm ± 2mm) reel
- \* 4 reels per box
- \* 6 boxes per carton

● **OUTLINE DIMENSIONS**

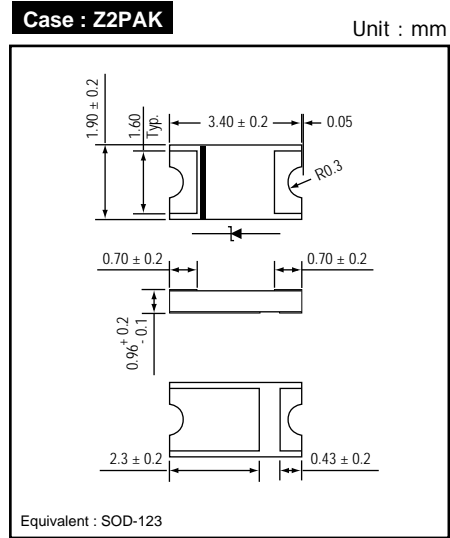

● **MARKING**

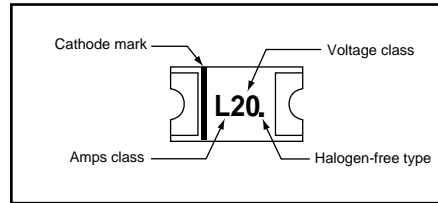

**Absolute Maximum Ratings (Ta = 25 °C)**

ITEM	Symbol	Conditions	Rating	Unit
			Z2PK220H	
Repetitive peak reverse voltage	VRRM		200	V
Average forward current	IF(AV)		2.0	A
Peak forward surge current	IFSM	8.3ms single half sine-wave	40	A
Operating junction temperature Range	Tj		-55 to +150	°C
Storage temperature Range	TSTG		-55 to +150	°C

**Electrical characteristics (Ta = 25 °C)**

ITEM	Symbol	Conditions	Min.	Typ.	Max.	Unit
Forward voltage (NOTE 1)	VF	IF = 2.0A	-	0.86	0.90	V
Repetitive peak reverse current (NOTE 1)	IRRM	VR = Max. VRRM , Ta = 25 °C	-	1.0	50	uA
Junction capacitance	Cj	VR = 4V, f = 1.0 MHz	-	115	-	pF
Thermal resistance	Rth(JA)	Junction to ambient (NOTE 2)	-	75	-	°C / W
	Rth(JL)	Junction to lead (NOTE 2)	-	17	-	°C / W

NOTES : (1) Pulse test width PW=300usec , 1% duty cycle.  
 (2) Mounted on P.C. board with 0.2 x 0.2"(5.0 x5.0mm) copper pad areas.

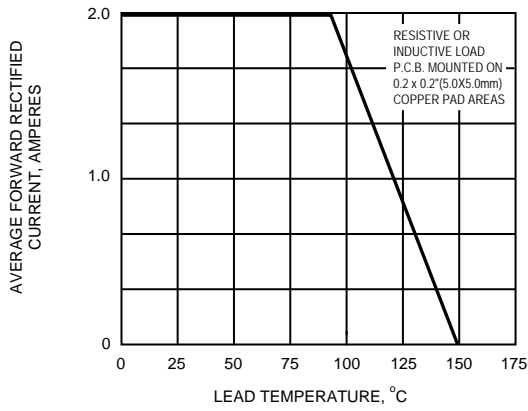
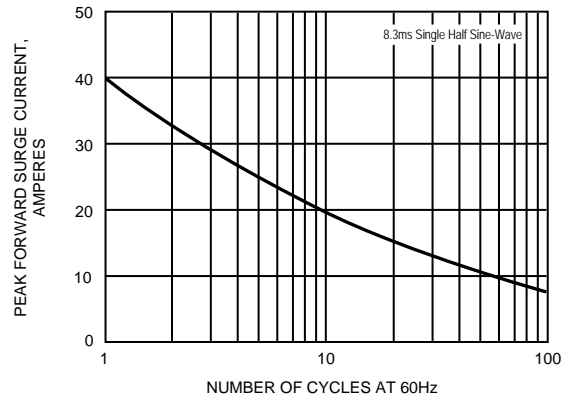
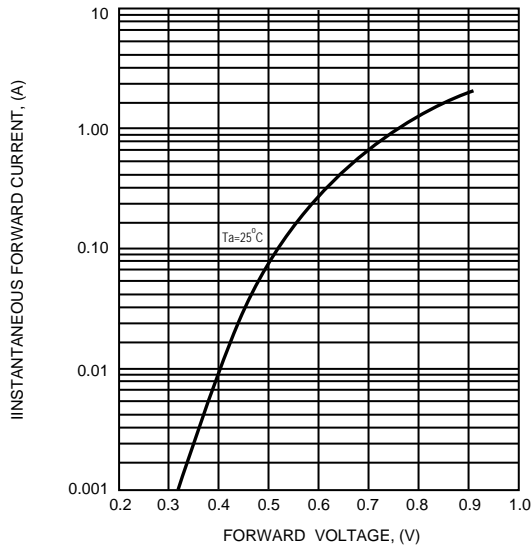
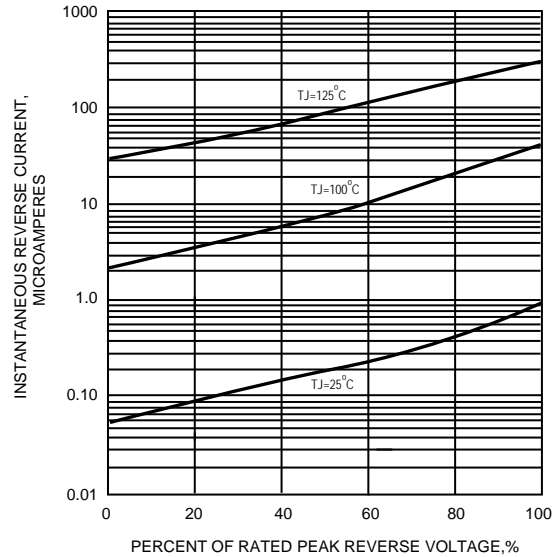
**FIG.1 - FORWARD CURRENT DERATING CURVE**

**FIG.2 - MAXIMUM NON-REPETITIVE PEAK FORWARD SURGE CURRENT**

**FIG.3 - TYPICAL INSTANTANEOUS FORWARD CHARACTERISTICS**

**FIG.4 - TYPICAL REVERSE CHARACTERISTICS**

**FIG.5 - TYPICAL JUNCTION CAPACITANCE**
