

Ref: CTSR 0.3-P, CTSR 0.6-P

For the electronic measurement of current: DC, AC, pulsed..., with galvanic separation between the primary circuit and the secondary circuit.



## Features

- Closed loop (compensated) current transducer
- Voltage output
- Single supply voltage
- PCB mounting.

## Advantages

- High accuracy
- Very low offset drift over temperature
- Wide aperture
- High overload capability
- High insulation capability
- Reference pin with two modes, Ref In and Ref Out
- Degauss and test functions.

## Applications

- Residual current measurement
- Leakage current measurement in transformerless PV inverters
- First human contact protection of PV arrays
- Failure detection in power sources
- Symmetrical fault detection (e.g. after motor inverter)
- Leakage current detection in stacked DC sources
- Single phase or three phase nominal current measurement up to  $\pm 30 \text{ A}$  per wire (DC or AC).

## Standards

- EN 50178: 1997
- IEC 61010-1: 2010
- UL 508: 2010.

## Application Domain

- Industrial
- Suitable to fulfil VDE 0126-1-1 and UL 1741.

### Absolute maximum ratings

Parameter	Symbol	Unit	Value
Supply voltage	$U_C$	V	7
Primary conductor temperature	$T_B$	°C	110
Overload capability (100 $\mu$ s, 500 A/ $\mu$ s)	$\hat{I}_P$	A	3300

Stresses above these ratings may cause permanent damage. Exposure to absolute maximum ratings for extended periods may degrade reliability.

### UL 508: Ratings and assumptions of certification

File # E189713 Volume: 2 Section: 3

#### Standards

- CSA C22.2 NO. 14-10 INDUSTRIAL CONTROL EQUIPMENT - Edition 11 - Revision Date 2011/08/01
- UL 508 STANDARD FOR INDUSTRIAL CONTROL EQUIPMENT - Edition 17 - Revision Date 2010/04/15

#### Ratings

Parameter	Symbol	Unit	Value Version P	Value Version TP
Primary involved potential*		V AC/DC	600	1000
Max surrounding air temperature	$T_A$	°C	105	
Primary current	$I_P$	A	According to series primary currents	
Secondary supply voltage	$U_C$	V DC	7	
Output voltage	$V_{out}$	V	0 to 7	

\* Environmental: For use in Pollution degree 3.

#### Conditions of acceptability

When installed in the end-use equipment, consideration shall be given to the following:

- 1 - A suitable enclosure shall be provided in the end-use application.
- 2 - The insulation between the primary and the secondary sensing circuits were evaluated with 4250 V AC for CTSR 0.6-TP/SP and 2200 V AC for CTSR 0.6-P in dielectric voltage withstand test.
- 5 - CTSR series is intended to be mounted on the printed wiring board of the end-use equipment.
- 7 - The uninsulated live parts of primary feeder and secondary circuit clearance spacing of Model CTSR XX-P series shall maintain at least 5.5 mm apart.
- 8 - Primary feeder of the devices shall be connected after an overvoltage device or system which has been evaluated by the Standard for Transient Voltage Surge Suppressors, UL 1449.

#### Marking

Only those products bearing the UL or UR Mark should be considered to be Listed or Recognized and covered under UL's Follow-Up Service. Always look for the Mark on the product.

**Insulation coordination**

Parameter	Symbol	Unit	Value	Comment
Rms voltage for AC insulation test, 50 Hz, 1 min	$U_d$	kV	5.4	
Impulse withstand voltage 1.2/50 $\mu$ s	$\hat{U}_w$	kV	10.1	
Partial discharge extinction rms voltage @ 10 pC	$U_e$	kV	1.65	
Clearance (pri. - sec.)	$d_{Cl}$	mm	11	Shortest distance through air
Creepage distance (pri. - sec.)	$d_{cp}$	mm	11	Shortest path along device body
Comparative tracking index	$CTI$	V	600	
Application example	-	V	1000	Reinforced insulation, CAT III, PD2 non uniform field according to EN 50178
Application example	-	V	600	Reinforced insulation, CAT III, PD3 non uniform field according to EN 50178, IEC 61010

**Environmental and mechanical characteristics**

Parameter	Symbol	Unit	Min	Typ	Max	Comment
Ambient operating temperature	$T_A$	$^{\circ}$ C	-40		105	
Ambient storage temperature	$T_S$	$^{\circ}$ C	-50		105	
Mass	$m$	g		28		

**Electrical data CTSR 0.3-P**

At  $T_A = 25\text{ °C}$ ,  $U_C = +5\text{ V}$ , output voltage referred to  $V_{ref}$ , unless otherwise noted (see Min., Max., typical definition paragraph) in page 10.

Parameter	Symbol	Unit	Min	Typ	Max	Comment
Primary nominal residual rms current	$I_{PRN}$	mA		300		
Primary residual current, measuring range	$I_{PRM}$	mA	-500		500	
Supply voltage	$U_C$	V	4.75	5	5.25	
Current consumption	$I_C$	mA		17.5	21.6	+ $I_P$ (mA)/ $N_S$ With $N_S = 1000$ turns - 40 .. 105 °C
Output voltage referred to GND (during Degauss cycle)	$V_{out}$	V		0.3	0.5	Note <sup>1)</sup>
Output voltage referred to $V_{ref}$ (test current)	$V_{out}$	V	0.7	1.2	1.7	Note <sup>1)</sup>
Reference voltage @ $I_P = 0$	$V_{ref}$	V	2.495	2.5	2.505	Internal reference
External reference voltage	$V_{ref}$	V	2.3		4	Internal reference of $V_{ref}$ input = 499 Ω Note <sup>1)</sup>
Electrical offset current referred to primary (Note <sup>2)</sup> )	$I_{OE}$	mA	-24	7	24	
Temperature coefficient of $V_{ref}$ @ $I_P = 0$	$TCV_{ref}$	ppm/K			±50	- 40 .. 105 °C
Temperature coefficient of $V_{OE}$ @ $I_P = 0$	$TCV_{OE}$	ppm/K			±570	ppm/K of 2.5 V - 40 .. 105 °C
Theoretical sensitivity	$G_{th}$	V/A		4		
Sensitivity error (Note <sup>2)</sup> )	$\epsilon_G$	%	-1.6	0.5	1.6	$R_L > 500\text{ k}\Omega$
Temperature coefficient of G	$TCG$	ppm/K			±230	- 40 .. 85 °C
					±400	- 40 .. 105 °C
Linearity error	$\epsilon_L$	% of $I_{PRM}$		0.5	1	
Magnetic offset current ( $1000 \times I_{PRN}$ ) referred to primary	$I_{OM}$	mA		17		
Output rms noise voltage (spectral density) 1 .. 10 kHz referred to primary	$V_{no}$	mV		6		$R_L > 500\text{ k}\Omega$
Reaction time @ 10 % of $I_{PRN}$	$t_{ra}$	µs		7		$R_L > 500\text{ k}\Omega$ , $di/dt > 5\text{ A}/\mu\text{s}$
Step response time to 90 % of $I_{PN}$	$t_r$	µs		50		$R_L > 500\text{ k}\Omega$ , $di/dt > 5\text{ A}/\mu\text{s}$
Frequency bandwidth (- 1 dB)	$BW$	kHz		3.5		$R_L > 500\text{ k}\Omega$
Accuracy (Note <sup>3)</sup> )	$X$	%			1.9	$= (\epsilon_G^2 + \epsilon_L^2)^{1/2}$

**Notes:** <sup>1)</sup> See "Application information" section.

<sup>2)</sup> Only with a primary nominal residual current, see paragraph "Primary nominal residual current and primary nominal current".

<sup>3)</sup> Accuracy @  $T_A$  and  $I_P$ :  $X_{TA} = (X^2 + (TCG \cdot 100 \cdot (T_A - 25))^2 + (TCV_{OE} \cdot 2.5 \cdot (T_A - 25) / G_{th} \cdot 100 / I_P)^2)^{1/2}$ .

Typical performance characteristics CTSR 0.3-P

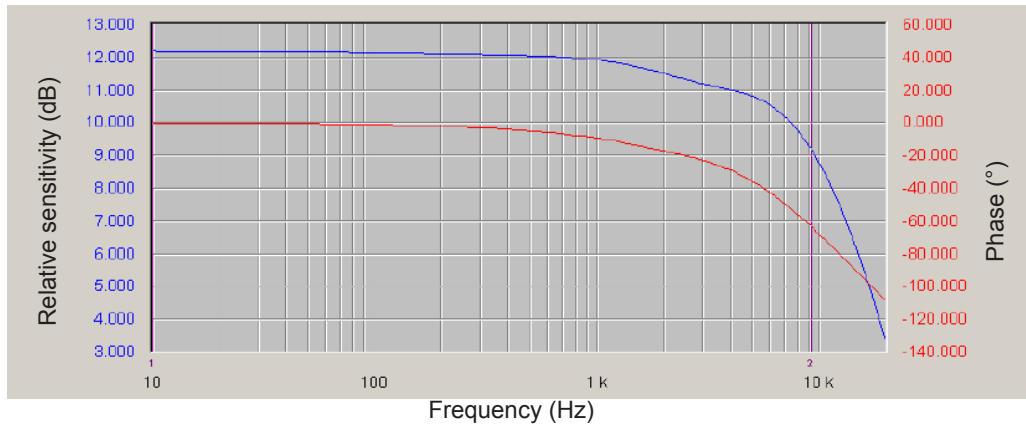

Figure 1: Frequency response

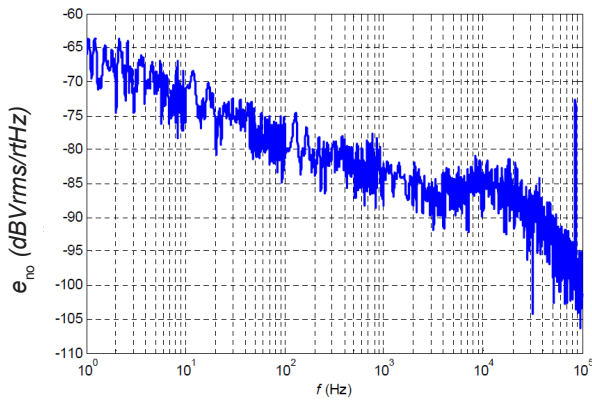

Figure 2: Output noise voltage spectral density

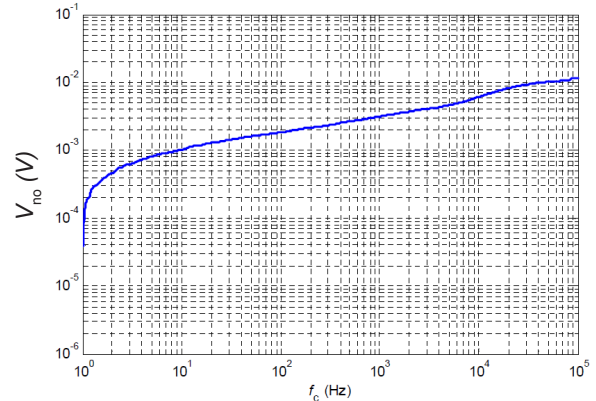

Figure 3: Output noise, cumulated rms

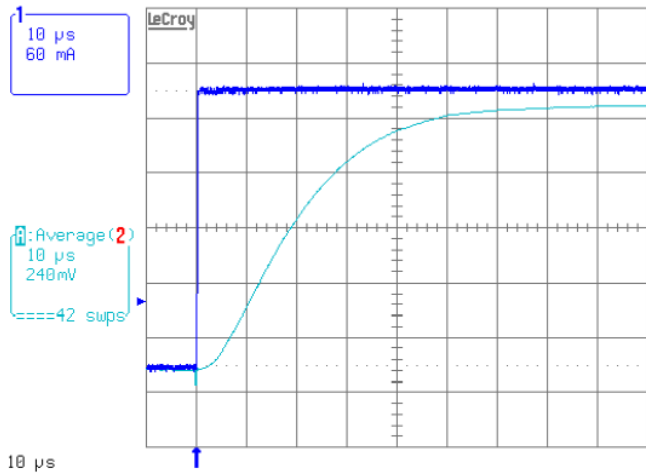

Figure 4: Typical step response

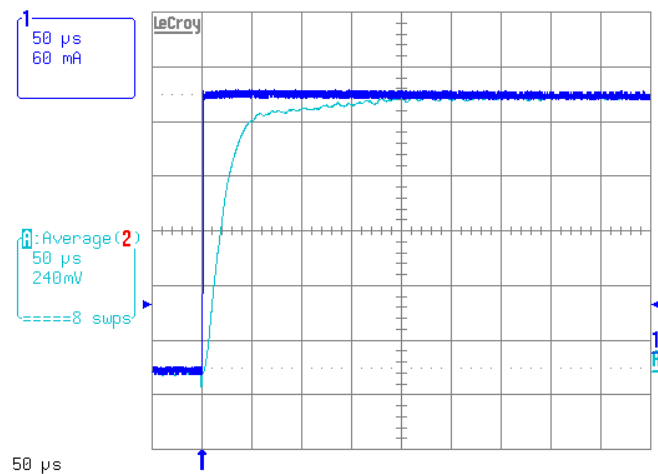

Figure 5: Typical step response

**Electrical data CTSR 0.6-P**

At  $T_A = 25\text{ °C}$ ,  $U_C = +5\text{ V}$ , output voltage referred to  $V_{ref}$ , unless otherwise noted (see Min., Max., typical definition paragraph) in page 10.

Parameter	Symbol	Unit	Min	Typ	Max	Comment
Primary nominal residual rms current	$I_{PRN}$	mA		600		
Primary residual current, measuring range	$I_{PRM}$	mA	-850		850	
Supply voltage	$U_C$	V	4.75	5	5.25	
Current consumption	$I_C$	mA		17.5	21.6	+ $I_P$ (mA)/ $N_S$ With $N_S = 1000$ turns - 40 .. 105 °C
Output voltage referred to GND (during Degauss cycle)	$V_{out}$	V		0.3	0.5	Note <sup>1)</sup>
Output voltage referred to $V_{ref}$ (test current)	$V_{out}$	V	0.4	0.75	1.1	Note <sup>1)</sup>
Reference voltage @ $I_P = 0$	$V_{ref}$	V	2.495	2.5	2.505	Internal reference
External reference voltage	$V_{ref}$	V	2.3		4	Internal reference of $V_{ref}$ input = 499 Ω Note <sup>1)</sup>
Electrical offset current referred to primary (Note <sup>2)</sup> )	$I_{OE}$	mA	-24	4.2	24	
Temperature coefficient of $V_{ref}$ @ $I_P = 0$	$TCV_{ref}$	ppm/K			±50	- 40 .. 105 °C
Temperature coefficient of $V_{OE}$ @ $I_P = 0$	$TCV_{OE}$	ppm/K			±520	ppm/K of 2.5 V - 40 .. 105 °C
Theoretical sensitivity	$G_{th}$	V/A		2.476		
Sensitivity error (Note <sup>2)</sup> )	$\epsilon_G$	%	-0.7	0.3	0.7	$R_L > 500\text{ k}\Omega$
Temperature coefficient of G	$TCG$	ppm/K			±100	- 40 .. 105 °C
Linearity error	$\epsilon_L$	% of $I_{PRM}$		0.4	1.3	
Magnetic offset current (1000 x $I_{PRN}$ ) referred to primary	$I_{OM}$	mA		17		
Output rms noise voltage (spectral density) 1 .. 10 kHz referred to primary	$V_{no}$	mV		4		$R_L > 500\text{ k}\Omega$
Reaction time @ 10 % of $I_{PRN}$	$t_{ra}$	µs		5		$R_L > 500\text{ k}\Omega$ , $di/dt > 5\text{ A}/\mu\text{s}$
Step response time to 90 % of $I_{PN}$	$t_r$	µs		30		$R_L > 500\text{ k}\Omega$ , $di/dt > 5\text{ A}/\mu\text{s}$
Frequency bandwidth (- 1 dB)	$BW$	kHz		9.5		$R_L > 500\text{ k}\Omega$
Accuracy (Note <sup>3)</sup> )	$X$	%			1.5	$= (\epsilon_G^2 + \epsilon_L^2)^{1/2}$

**Notes:** <sup>1)</sup> See "Application information" section.

<sup>2)</sup> Only with a primary nominal residual current, see paragraph "Primary nominal residual current and primary nominal current".

<sup>3)</sup> Accuracy @  $T_A$  and  $I_P$ :  $X_{TA} = (X^2 + (TCG \cdot 100 \cdot (T_A - 25))^2 + (TCV_{OE} \cdot 2.5 \cdot (T_A - 25) / G_{th} \cdot 100 / I_P)^2)^{1/2}$ .

Typical performance characteristics CTSR 0.6-P

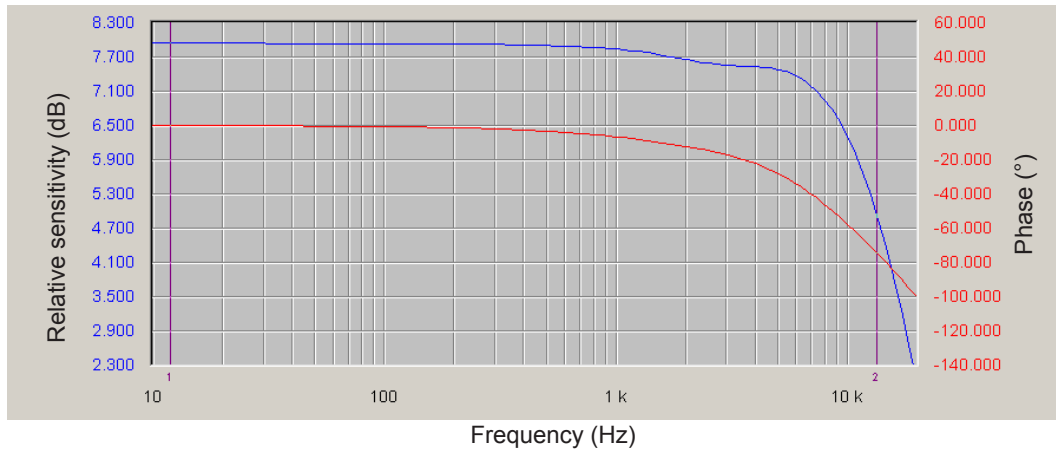

Figure 6: Frequency response

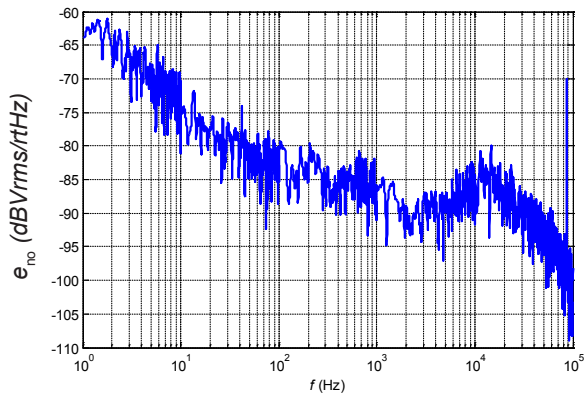

Figure 7: Output noise voltage spectral density

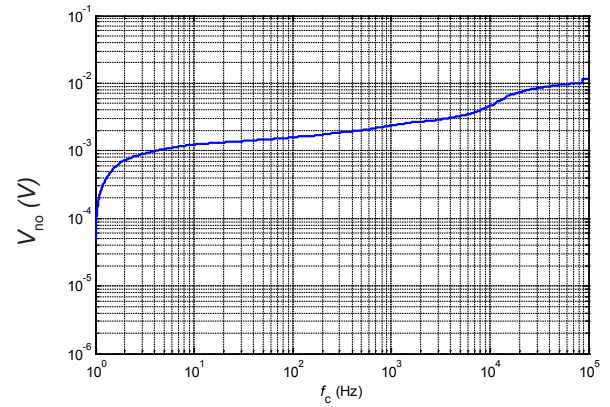

Figure 8: Output noise, cumulated rms

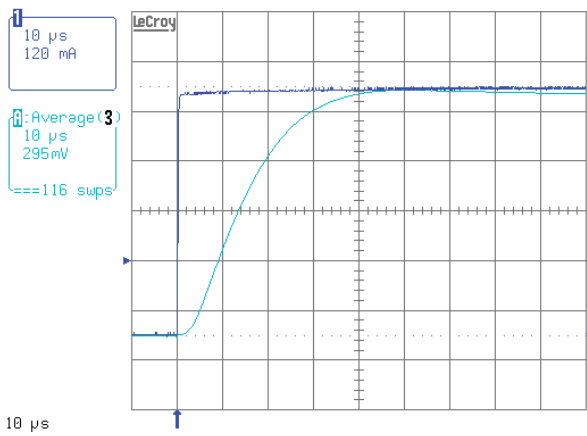

Figure 9: Typical step response

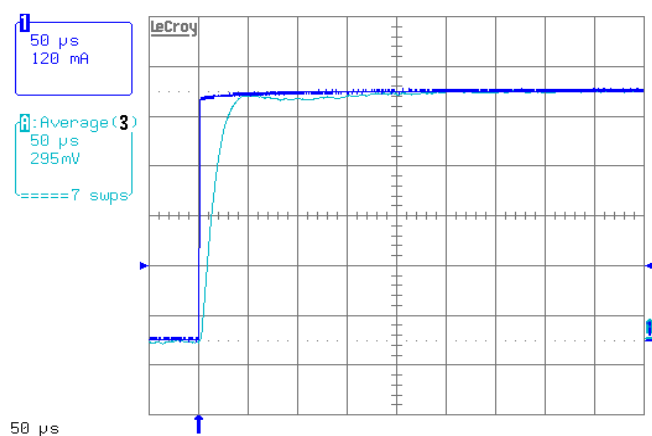

Figure 10: Typical step response

## Application information

### Filtering, decoupling CTSR transducer

#### Supply voltage $U_c$ (5 V):

The CTSR transducers have internal decoupling capacitors, but in the case of a power supply track on the application PCB having a high impedance, it is advised to provide local decoupling, 100 nF or more, located close to the transducer.

#### Reference $V_{ref}$

Ripple present on the  $V_{ref}$  pin can be filtered with a low value of capacitance because of the internal 499 ohm series resistance. The CTSR transducers have an internal capacitor of 22 nF between  $V_{ref}$  pin and Gnd pin and the maximum filter capacitance value which could be added is 1  $\mu$ F. Adding a larger decoupling capacitor will increase the activation delay of degauss.

#### Output $V_{out}$

The CTSR transducers have an internal low pass filter 470 ohm/22 nF; if a decoupling capacitor is added on  $V_{out}$  pin, the bandwidth and the response time will be affected. In case of short circuit, the transducer CTSR can source or sink up to a maximum of 10 mA on its output  $V_{out}$ .

### Using an external reference voltage

If the  $V_{ref}$  pin of the transducer is not used it could be either left unconnected or filtered according to the previous paragraph "Reference  $V_{ref}$ ".

The  $V_{ref}$  pin has two modes Ref out and Ref In:

- In the Ref out mode the 2.5 V internal precision reference is used by the transducer as the reference point for bipolar measurements; this internal reference is connected to the  $V_{ref}$  pin of the transducer through a 499 ohms resistor. It tolerates sink or source currents up to  $\pm 5$  mA, but the 499 ohms resistor prevents this current to exceed these limits.
- In the Ref In mode, an external reference voltage is connected to the  $V_{ref}$  pin; this voltage is specified in the range 2.3 to 4 V and is directly used by the transducer as the reference point for measurements. The external reference voltage  $V_{ref}$  must be able:
  - o either to source a typical current of  $\frac{V_{ref}-2.5}{499}$ , the maximum value will be 3 mA when  $V_{ref} = 4$  V.
  - o or to sink a typical current of  $\frac{2.5-V_{ref}}{499}$ , the maximum value will be 0.4 mA when  $V_{ref} = 2.3$  V.

The following graphs show how the measuring range of the transducer depends on the external reference voltage value  $V_{ref}$  ( $U_c = 5$  V).

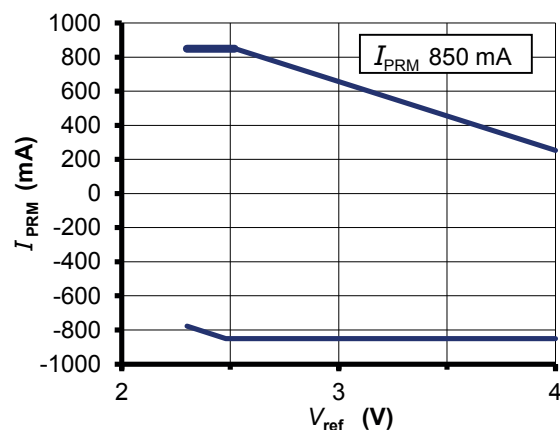
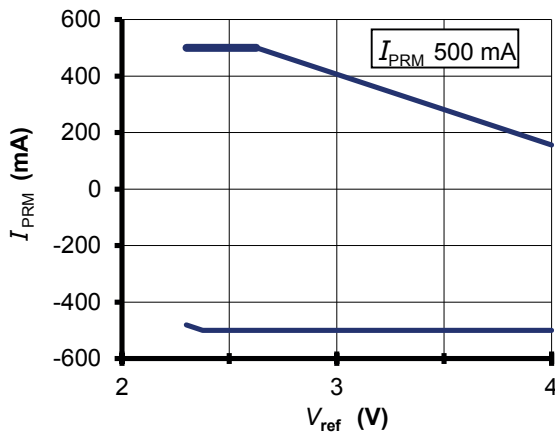

Upper limit:  $I_p = 500$  mA ( $V_{ref} = 2.3 \dots 2.625$  V)  
 Upper limit:  $I_p = -250 \cdot V_{ref} + 1156.25$  ( $V_{ref} = 2.625 \dots 4$  V)  
 Lower limit:  $I_p = -250 \cdot V_{ref} + 93.75$  ( $V_{ref} = 2.3 \dots 2.375$  V)  
 Lower limit:  $I_p = -500$  mA ( $V_{ref} = 2.375 \dots 4$  V)

Upper limit:  $I_p = 850$  mA ( $V_{ref} = 2.3 \dots 2.52$  V)  
 Upper limit:  $I_p = -403.88 \cdot V_{ref} + 1867.93$  ( $V_{ref} = 2.52 \dots 4$  V)  
 Lower limit:  $I_p = -403.88 \cdot V_{ref} + 151.45$  ( $V_{ref} = 2.3 \dots 2.48$  V)  
 Lower limit:  $I_p = -850$  mA ( $V_{ref} = 2.48 \dots 4$  V)



### Primary nominal residual current and primary nominal current

The primary nominal residual current is the sum of the instantaneous values of all currents flowing through the aperture of the transducer.

The primary nominal current is the current flowing through any conductor placed into the aperture of the transducer.

The presence of a primary nominal current DC or AC leads to an additional uncertainty.

For example, with a primary nominal current of 30 A the uncertainty referred to primary is typical 4.3 mA.

### CTSR transducer in Test mode

When the  $V_{ref}$  pin is forced at a low level voltage between 0 and 1 V and is maintained at this level, the output voltage  $V_{out}$  of CTSR transducer exhibits a fixed value (see specification) as if it measured a primary test current.

The activation time of test mode is min 30 ms. The CTSR transducer can be maintained in test mode as long as needed for checking that it is fully operating.

### CTSR transducer in Degauss mode

The CTSR transducers go in degauss mode automatically at each power on or on demand by using the  $V_{ref}$  pin.

At power on:

A degauss is automatically generated at each power on of the CTSR transducer; during degaussing the output voltage  $V_{out}$  is maintained at 0.3 V typ. (max 0.5 V). After c.a. 110 ms, the output voltage  $V_{out}$  is released and takes the normal operation level in relation with the measured primary current.

Using  $V_{ref}$  pin:

When the pin  $V_{ref}$  is released from the Low level voltage defined in the Test mode above, there is a rising edge on  $V_{ref}$  which generates an automatic degauss.

The activation of degauss takes typically 40  $\mu$ s after releasing  $V_{ref}$  pin, then degauss lasts typically 110 ms.

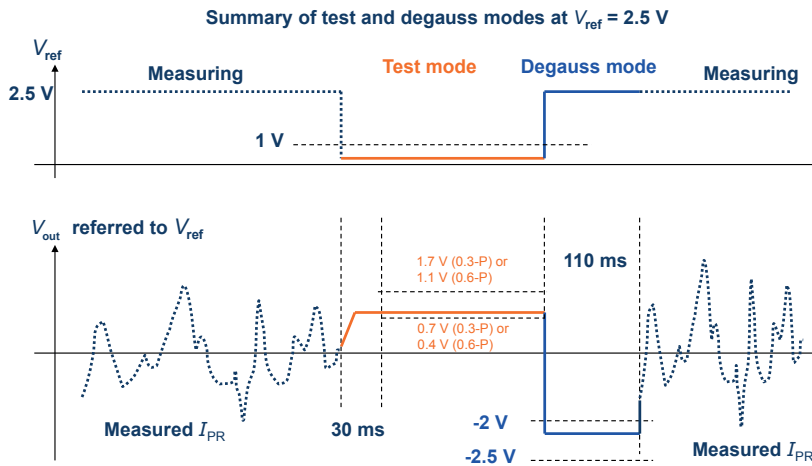

### Isolation around the CTSR transducer housing

Due to the joint between the case and the cover of the CTSR transducer, there is some isolation distance to respect when primary conductors pass around the CTSR housing.

The figure below shows the joint and the apertures where the clearance between the secondary part inside the CTSR transducer and the surface of the housing is 3 mm (label E).

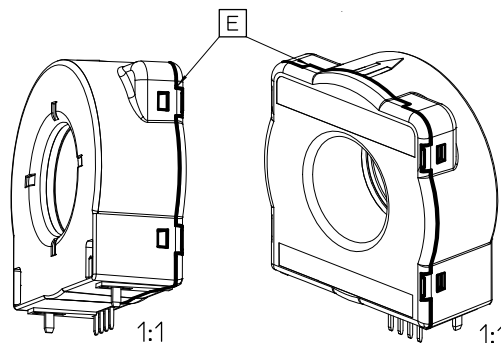

PCB footprint CTSR series

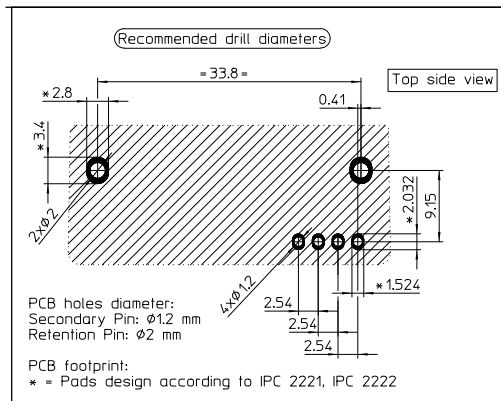

Assembly on PCB

- Recommended PCB hole diameter: 1.2 mm for secondary pin, 2 mm for retention pin
- Maximum PCB thickness: 2.4 mm
- Wave soldering profile: maximum 260 °C, 10 s  
No clean process only

The two retention pins inserted into the case of the transducer are electrically isolated by the housing. Because one of them is close to the secondary connector, it is recommended to connect both to the secondary side GND or  $+U_c$ . Consequently any primary conductor must be placed in the PCB at the requested isolation distance regarding these secondary sides (see also paragraph "Isolation around the CTSR transducer housing").

Definition of typical, minimum and maximum values

Minimum and maximum values for specified limiting and safety conditions have to be understood as such as well as values shown in "typical" graphs. On the other hand, measured values are part of a statistical distribution that can be specified by an interval with upper and lower limits and a probability for measured values to lie within this interval. Unless otherwise stated (e.g. "100 % tested"), the LEM definition for such intervals designated with "min" and "max" is that the probability for values of samples to lie in this interval is 99.73 %. For a normal (Gaussian) distribution, this corresponds to an interval between -3 sigma and +3 sigma. If "typical" values are not obviously mean or average values, those values are defined to delimit intervals with a probability of 68.27 %, corresponding to an interval between -sigma and +sigma for a normal distribution. Typical, maximal and minimal values are determined during the initial characterization of a product.

Safety

This transducer must be used in limited-energy secondary circuits according to IEC 61010-1.



This transducer must be used in electric/electronic equipment with respect to applicable standards and safety requirements in accordance with the manufacturer's operating instructions.



Caution, risk of electrical shock

When operating the transducer, certain parts of the module can carry hazardous voltage (eg. primary busbar, power supply). Ignoring this warning can lead to injury and/or cause serious damage. This transducer is a build-in device, whose conducting parts must be inaccessible after installation. A protective housing or additional shield could be used. Main supply must be able to be disconnected.

**Dimensions** (in mm, general tolerance  $\pm 0.3$  mm)

