

Silicon NPN Phototransistor

Version 1.3

SFH 313 FA



Features:

- **Spectral range of sensitivity:** (typ) 740 ... 1080 nm
- **Package:** 5mm Radial (T 1 3/4), Epoxy
- **Special:** 5 mm plastic package
- High photosensitivity
- Especially suitable for applications from 740 nm to 1080 nm

Applications

- Computer-controlled flashes
- Photointerrupters
- Industrial electronics
- For control and drive circuits

Ordering Information

Type:	Photocurrent I_{PCE} [μ A] $\lambda = 950 \text{ nm}$, $E_e = 0.5 \text{ mW/cm}^2$, $V_{CE} = 5 \text{ V}$	Ordering Code
SFH 313 FA	≥ 2500	Q62702P1674
SFH 313 FA-2/3	4000 ... 12500	Q62702P3597
SFH 313 FA-3/4	≥ 6300	Q62702P5196

Maximum Ratings ($T_A = 25\text{ °C}$)

Parameter	Symbol	Values	Unit
Operating and storage temperature range	$T_{op}; T_{stg}$	-40 ... 100	°C
Collector-emitter voltage	V_{CE}	70	V
Collector current	I_C	50	mA
Collector surge current ($\tau < 10\ \mu\text{s}$)	I_{CS}	100	mA
Emitter-collector voltage	V_{EC}	7	V
Total Power dissipation	P_{tot}	200	mW
Thermal resistance	R_{thJA}	375	K / W
ESD withstand voltage (acc. to ANSI/ ESDA/ JEDEC JS-001 - HBM)	V_{ESD}	2000	V

Characteristics ($T_A = 25\text{ °C}$, $\lambda = 950\text{ nm}$)

Parameter		Symbol	Values	Unit
Wavelength of max. sensitivity	(typ)	$\lambda_{S\ max}$	870	nm
Spectral range of sensitivity	(typ)	$\lambda_{10\%}$	(typ) 740 ... 1080	nm
Radiant sensitive area	(typ)	A	0.55	mm ²
Dimensions of chip area	(typ)	L x W	(typ) 1 x 1	mm x mm
Half angle	(typ)	φ	± 10	°
Capacitance ($V_{CE} = 5\text{ V}$, $f = 1\text{ MHz}$, $E = 0$)	(typ)	C_{CE}	10	pF
Dark current ($V_{CE} = 20\text{ V}$, $E = 0$)	(typ (max))	I_{CE0}	3 (≤ 200)	nA

Grouping ($T_A = 25\text{ °C}$, $\lambda = 950\text{ nm}$)

Group	Min Photocurrent $E_e = 0.5\text{ mW/cm}^2$, $V_{CE} = 5\text{ V}$ $I_{PCE, min} [\mu\text{A}]$	Max Photocurrent $E_e = 0.5\text{ mW/cm}^2$, $V_{CE} = 5\text{ V}$ $I_{PCE, max} [\mu\text{A}]$	Rise and fall time $I_C = 1\text{ mA}$, $V_{CC} = 5\text{ V}$, $R_L = 1\text{ k}\Omega$ $t_r, t_f [\mu\text{s}]$	Collector-emitter saturation voltage $I_C = I_{PCEmin} \times 0.3$, $E_e = 0.5\text{ mW/cm}^2$ $V_{CEsat} [\text{mV}]$
-1	2500	5000	8	150
-2	4000	8000	10	150
-3	6300	12500	12	150
-4	10000		14	150

Note.: I_{PCEmin} is the min. photocurrent of the specified group.

Relative Spectral Sensitivity ^{1) page 9}

SFH 313 FA $S_{rel} = f(\lambda)$

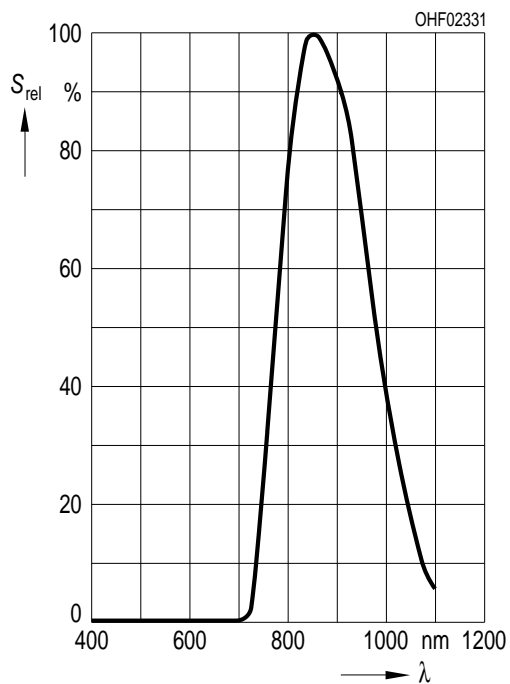

Photocurrent ^{1) page 9}

$I_{PCE} = f(E_e)$, $V_{CE} = 5\text{ V}$

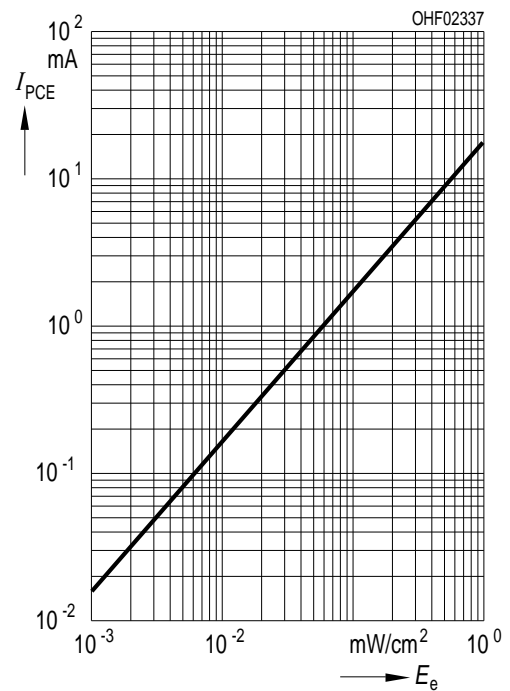

Photocurrent ^{1) page 9}

$I_{PCE} = f(V_{CE}), E_e = \text{Parameter}$

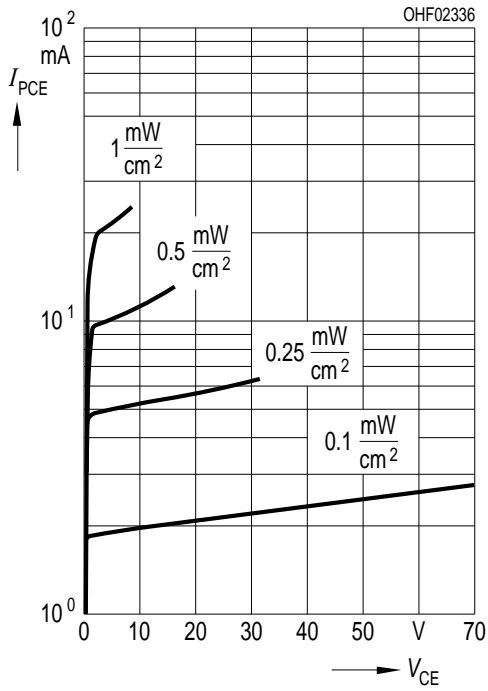

Photocurrent ^{1) page 9}

$I_{PCE} / I_{PCE}(25^\circ\text{C}) = f(T_A), V_{CE} = 5 \text{ V}$

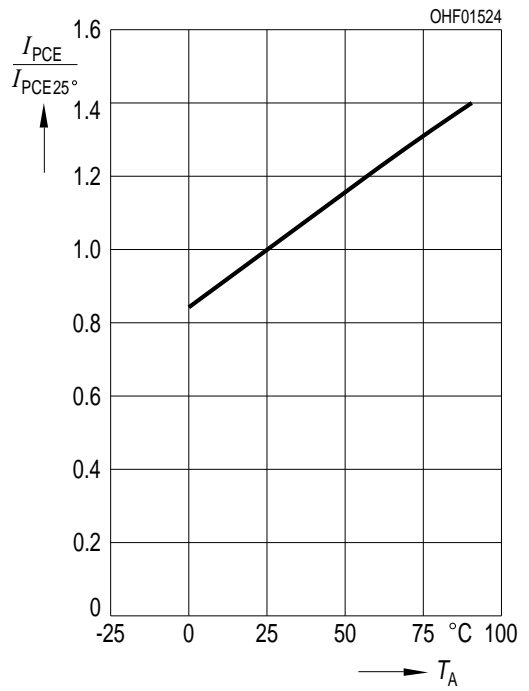

Dark Current ^{1) page 9}

$I_{CEO} = f(V_{CE}), E = 0$

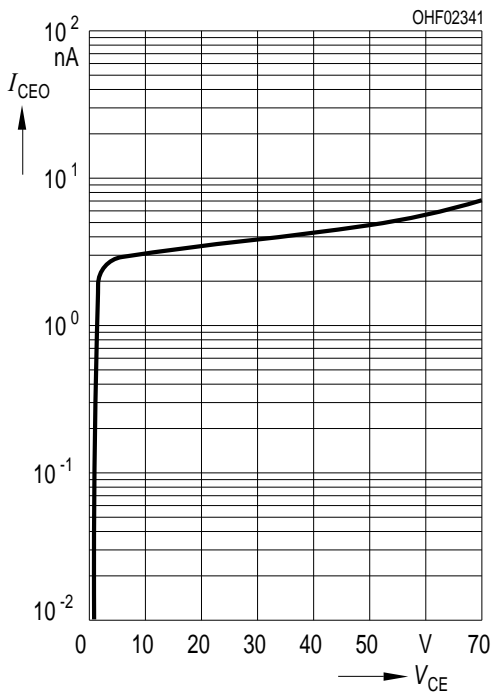

Dark Current ^{1) page 9}

$I_{CEO} = f(T_A), E = 0$

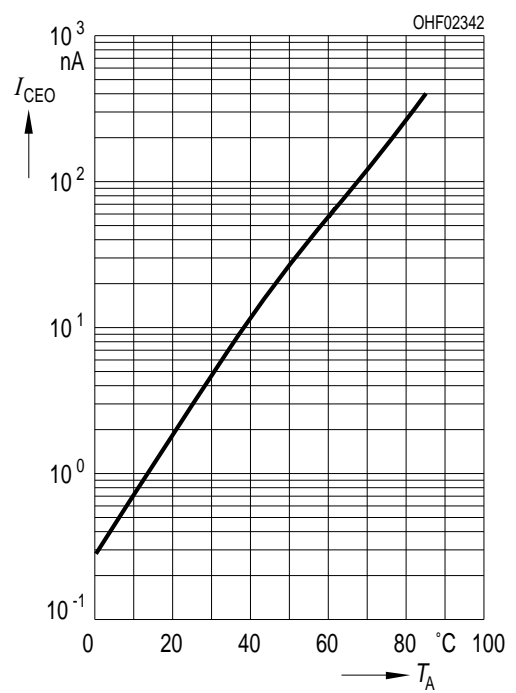

Collector-Emitter Capacitance ^{1) page 9}

$C_{CE} = f(V_{CE}), f = 1 \text{ MHz}, E = 0$

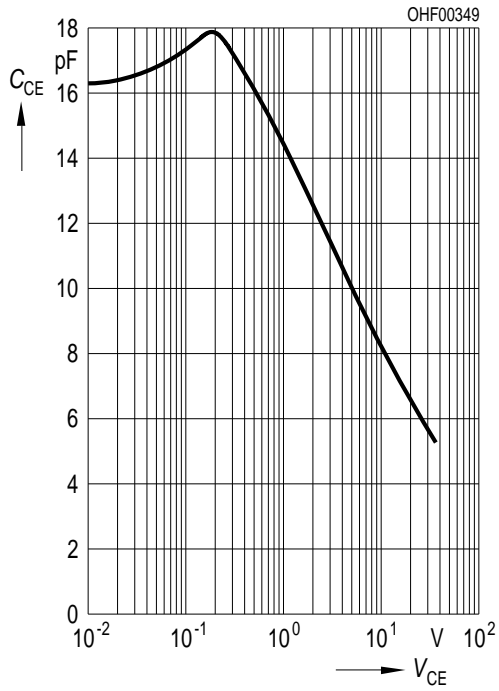

Power Consumption

$P_{tot} = f(T_A)$

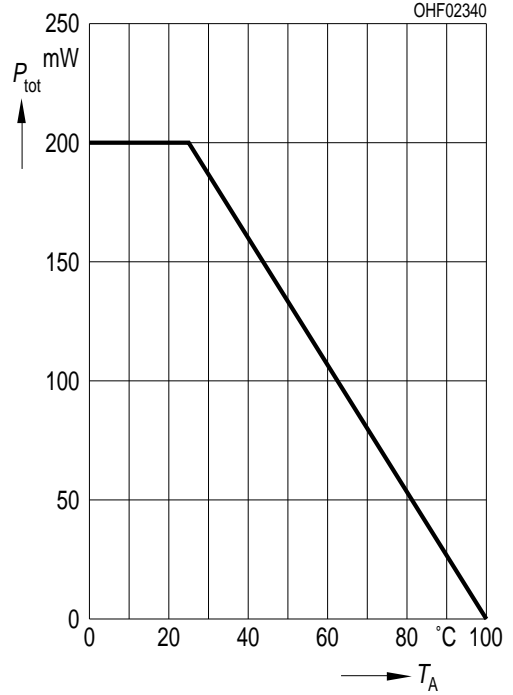

Directional Characteristics ^{1) page 9}

$S_{rel} = f(\phi)$

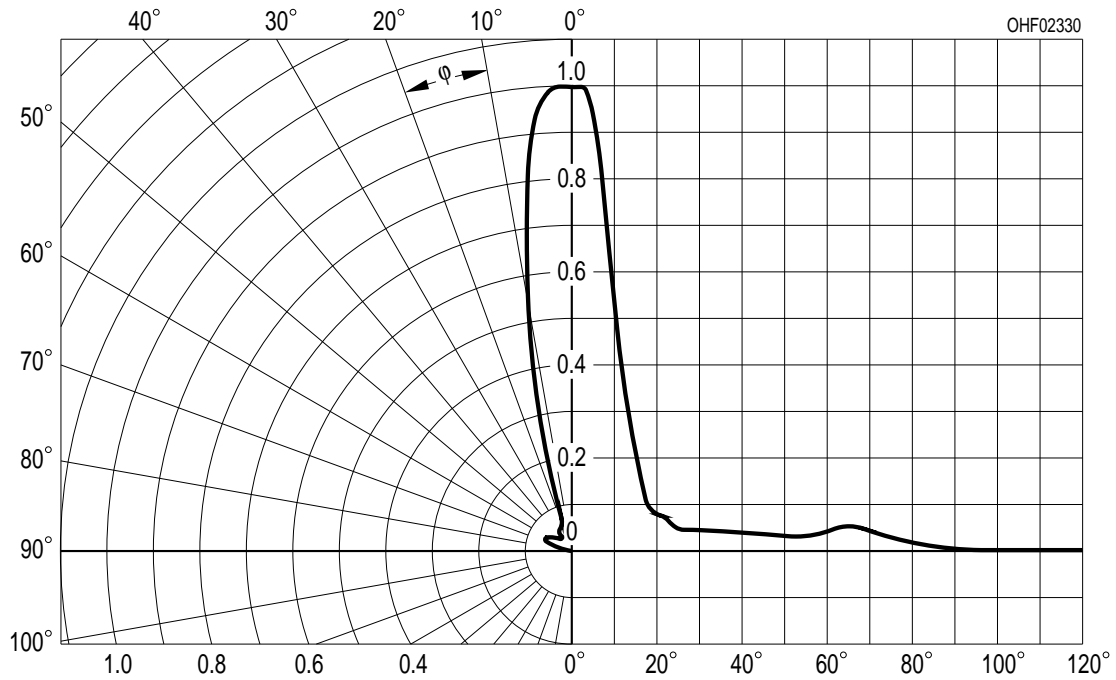

Package Outline

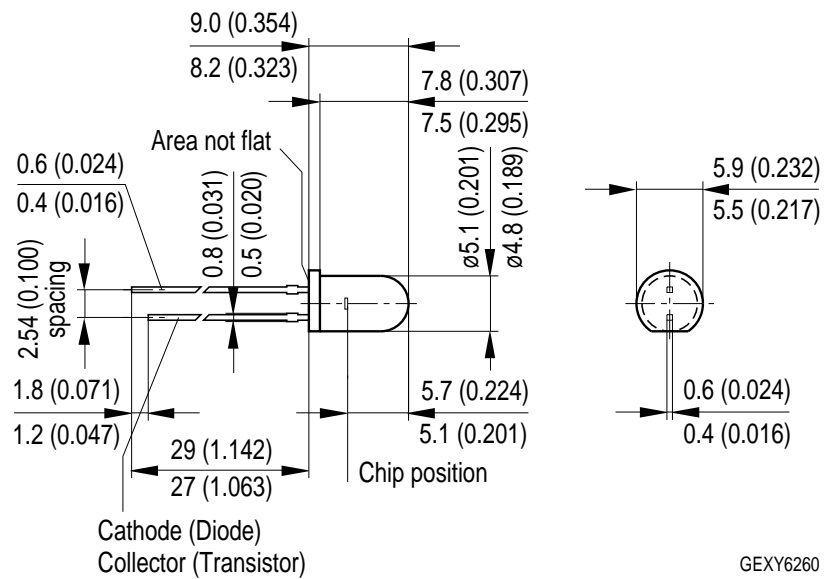

Dimensions in mm (inch).

Package

5mm Radial (T 1 ¾), Epoxy

Approximate Weight:

0.4 g

Note

Packing information is available on the internet (online product catalog).

Recommended Solder Pad

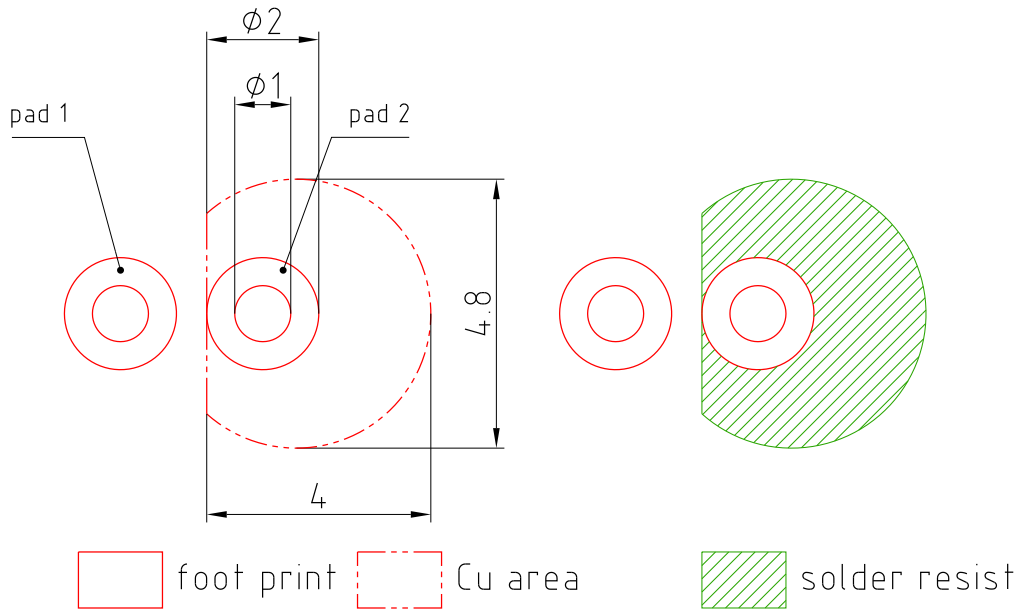

E062.3010.188-01

Dimensions in mm.

Note:

pad 1: emitter

TTW Soldering

IEC-61760-1 TTW

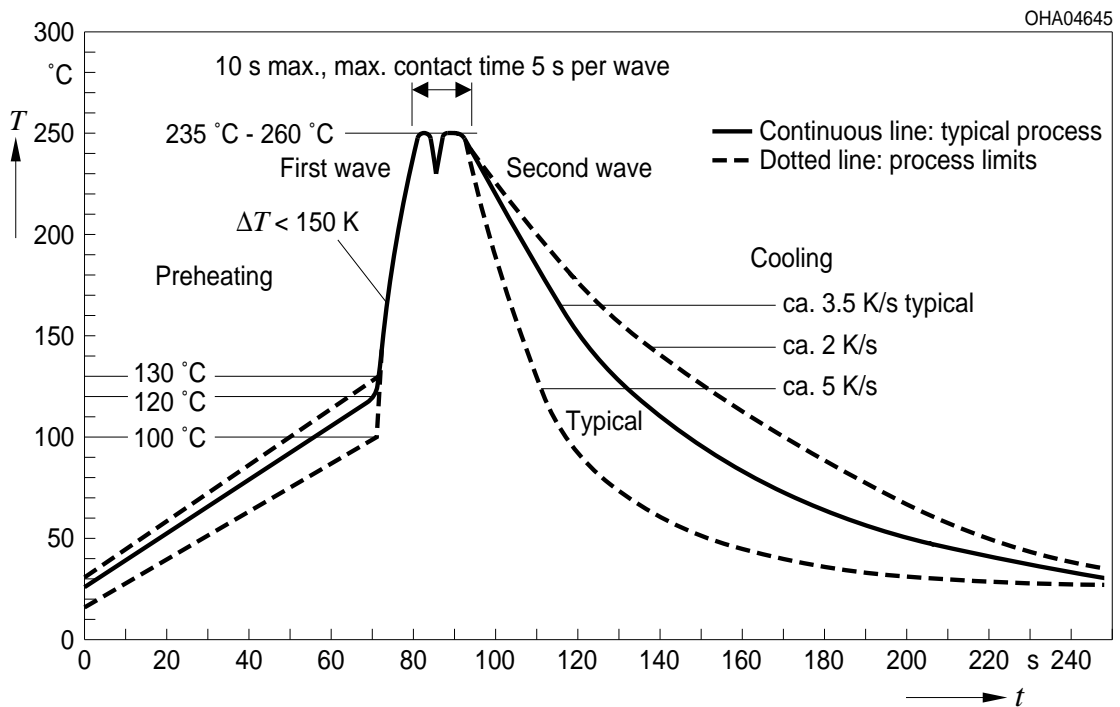

Disclaimer

Language english will prevail in case of any discrepancies or deviations between the two language wordings.

Attention please!

The information describes the type of component and shall not be considered as assured characteristics.

Terms of delivery and rights to change design reserved. Due to technical requirements components may contain dangerous substances.

For information on the types in question please contact our Sales Organization.

If printed or downloaded, please find the latest version in the Internet.

Packing

Please use the recycling operators known to you. We can also help you – get in touch with your nearest sales office.

By agreement we will take packing material back, if it is sorted. You must bear the costs of transport. For packing material that is returned to us unsorted or which we are not obliged to accept, we shall have to invoice you for any costs incurred.

Components used in life-support devices or systems must be expressly authorized for such purpose!

Critical components* may only be used in life-support devices** or systems with the express written approval of OSRAM OS.

*) A critical component is a component used in a life-support device or system whose failure can reasonably be expected to cause the failure of that life-support device or system, or to affect its safety or the effectiveness of that device or system.

**) Life support devices or systems are intended (a) to be implanted in the human body, or (b) to support and/or maintain and sustain human life. If they fail, it is reasonable to assume that the health and the life of the user may be endangered.

Glossary

- ¹⁾ **Typical Values:** Due to the special conditions of the manufacturing processes of LED, the typical data or calculated correlations of technical parameters can only reflect statistical figures. These do not necessarily correspond to the actual parameters of each single product, which could differ from the typical data and calculated correlations or the typical characteristic line. If requested, e.g. because of technical improvements, these typ. data will be changed without any further notice.

Published by OSRAM Opto Semiconductors GmbH
Leibnizstraße 4, D-93055 Regensburg
www.osram-os.com © All Rights Reserved.

EU RoHS and China RoHS compliant product



此产品符合欧盟 RoHS 指令的要求；
按照中国的相关法规和标准，不含有毒有害物质或元素。