

FEATURES

- Very Low Radius Vector Variation (Transformation Ratio) ($\pm 0.1\%$)
- High Accuracy (± 2 arc-mins at $+25^\circ\text{C}$)
- 12 or 14 Bit Resolution
- No 5 Volt Power Supply Required
- MIL Spec/Hi Rel Versions Available
- Internal 1.3VA Amplifiers
- Internal Transformers (400Hz Option)
- No Trims or Adjustments Necessary

APPLICATIONS

- Driving Control Transformers
- Driving Torque Receivers (with External Amplifiers)
- Servo Mechanisms
- Retransmission Systems
- Positional Control

GENERAL DESCRIPTION

The DSC1705 and DSC1706 are Digital to Synchro and Digital to Resolver converters capable of driving electromechanical loads of up to 1.3VA.

They accept a 14 or 12 bit digital input representing angle and a reference voltage of either 60Hz or 400Hz, and produce a 3 wire or 4 wire output suitable for driving Synchros or Resolvers.

The 400Hz converters contain internal 1.3VA amplifiers as well as output and reference transformers.

The 60Hz versions contain internal 1.3VA amplifiers but require external output and reference transformers.

If it is necessary to drive a load requiring more than 1.3VA, options for both the 400Hz and 60Hz converters are available allowing the use of external amplifiers and transformers.

RADIUS VECTOR

One of the outstanding features of these converters is the almost negligible Radius Vector variation (Transformation Ratio).

On many Digital to Synchro Converters presently available, the individual sine and cosine outputs produced do not follow the exact sine and cosine laws, and depending upon angle can vary up to $\pm 7\%$. This is not always important as the ratio of the sine to the cosine, i.e., the tangent, is always correct to the specified accuracy of the converter. There are cases however, when driving torque receivers and certain servo control loops when this variation is unacceptable.

The design of the DSC1705 and DSC1706 has reduced this variation to less than $\pm 0.1\%$. This means that when the converters are used in closed loop servo systems, the gain of the closed loop is independent of the digital input angle, thus making reference correction unnecessary.

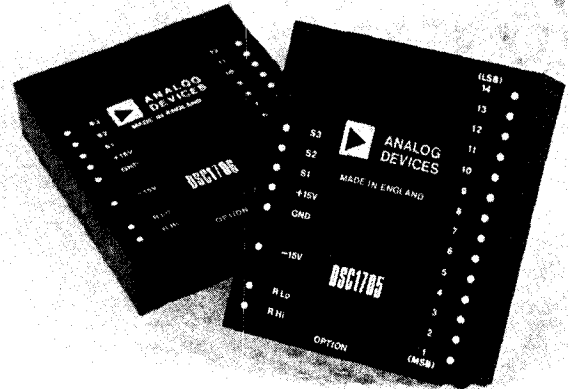

MODELS AVAILABLE

The two Digital to Synchro/Resolver converters described in this data sheet differ primarily in the areas of resolution and accuracy as follows:-

Model DSC1705XYZ is a 14 bit converter with an overall accuracy of ± 4 arc-minutes.

Model DSC1706XYZ is a 12 bit converter with an overall accuracy of ± 8 arc-minutes.

The XYZ option code defines the option thus: (X) signifies the operating temperature range, (Y) signifies the reference frequency, (Z) signifies the output and the reference voltages, whether the output is in Synchro or Resolver format and whether external transformers are required.

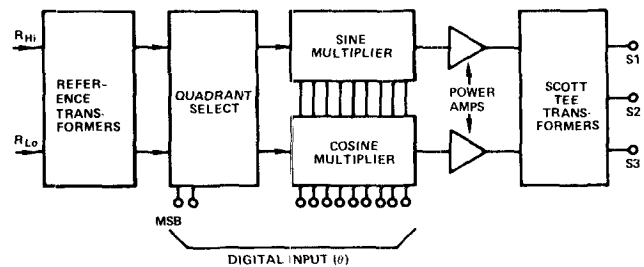

Principle of Operation

FUNCTIONAL DIAGRAM, DSC1705 and DSC1706

The principle of operation of the converters described in this data sheet is shown in the diagram above.

SPECIFICATIONS (typical @ +25°C unless otherwise noted)

Model	DSC1705	DSC1706
ACCURACY ¹	±4 arc-minutes	±8 arc-minutes
RESOLUTION	14 Bits (1LSB = 1.3 arc-minutes)	12 Bits (1LSB = 5.3 arc-minutes)
INPUT CODE	14 Bits Natural Parallel Binary with MSB = 180°	12 Bits Natural Parallel Binary with MSB = 180°
REFERENCE VOLTAGE INPUT		
With Internal Transformers		
Low Level	26V rms	*
High Level	115V rms	*
External Transformer Options ²		
	4V rms	*
REFERENCE FREQUENCY	60Hz or 400Hz	*
REFERENCE INPUT IMPEDANCE		
With Internal Transformers		
Low Level	20kΩ	*
High Level	200kΩ	*
External Transformer Options ²		
	10kΩ	*
DIGITAL INPUT (TTL COMPATIBLE)	1TTL Load	*
OUTPUT VOLTAGE AND FORMAT		
With Internal Transformers		
Low Level	11.8V rms Line-to-Line Synchro or Resolver	*
High Level	90V rms Line-to-Line Synchro or Resolver	*
External Transformer Options ³		
	7V rms Sine and Cosine	*
LOAD CAPABILITY	1.3VA	*
SHORT CIRCUIT PROTECTION	Continuous for 5 minutes	*
OUTPUT SETTLING TIME ⁴	50μs for 180° Step	*
RADIUS VECTOR VARIATION (Transformation Ratio)	±0.1% max Sine and Cosine	*
INTERNAL TRANSFORMER ISOLATION	500V dc	*
POWER SUPPLIES		
Voltage	±15V dc ±5%	*
Current		
(a) No Load	95mA per Line	*
(b) Full Load Mean	225mA per Line	*
WARM-UP TIME	1sec to Full Accuracy	*
OPERATING TEMPERATURE RANGE		
	0 to +70°C Standard	*
	-55°C to +105°C Extended	*
STORAGE TEMPERATURE RANGE	-55°C to +125°C	*
SIZE		
	3.125" x 2.625" x 0.8"	*
	(79.4mm x 66.7mm x 20.3mm)	*
WEIGHT	8 ounces (224 grams) max	*
MEAN TIME BETWEEN FAILURES (MTBF) CALCULATED ⁵	150,000 Hours	*

NOTES

¹ Accuracy applies over the full operating temperature range of the option and for:

- (a) ±10% reference frequency and amplitude variation.
- (b) 10% harmonic distortion on the reference.
- (c) ±5% power supply variation.
- (d) Any balanced load from no load to full load.

² Refers to input to converter and not to external transformers.

³ Refers to output from internal converter amplifiers and not from external transformers.

⁴ Dependent upon option and load conditions.

⁵ With MIL-STD-883B components.

Specifications subject to change without notice.

CONNECTING THE CONVERTER

400Hz options. All these converters contain internal output and reference transformers.

The digital input should be connected to pins "1" through "12" on the DSC1706 and pins "1" through "14" on the DSC1705, noting that pin "1" is the Most Significant Bit (MSB).

"S1", "S2" and "S3" should be connected to the appropriate inputs on the synchro being driven. ("S4" is used also when connection is made to a resolver).

The reference should be connected to "R_{Hi}" and "R_{Lo}" ensuring that the phase is correct.

"GND" is the common for both power supplies and digital inputs.

60Hz Options. For 60Hz operation, an external transformer, STM1679 is required.

The power supplies and digital input should be connected as for the 400Hz version.

The STM1679 transformer should have its pins "SIN", "COS" and "V" connected to the equivalent pins on the converter. The "GND(SIG)" and "GND(REF)" should both be connected to "GND" on the converter.

The outputs to the load should be taken from "S1", "S2" and "S3" on the STM1679 transformer ("S4" also in the case of a resolver).

The reference input should be made to "R_{Hi}" and "R_{Lo}" on the STM1679.

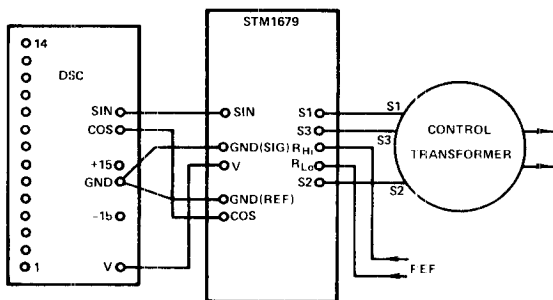

*60Hz Connection to a Control Transformer
(Diagram Shows Bottom View of Modules)*

OPERATION WITH EXTERNAL AMPLIFIERS OR TRANSFORMER OTHER THAN STM1679

For certain applications, the power output required by the load will be greater than the 1.3VA supplied by the internal amplifiers. Thus external amplifiers and transformers will be needed. Products offered to fulfill this requirement are:

SPA1695 – Dual 5VA Amplifier

STM1696 – 5VA output and reference transformers (400Hz)

STM1697 – 5VA output and reference transformers (60Hz)

If you have a requirement for such products please request the data sheet.

CONVERTER OUTLINE DIMENSIONS AND PIN CONNECTION DIAGRAM

Dimensions shown in inches and (mm).

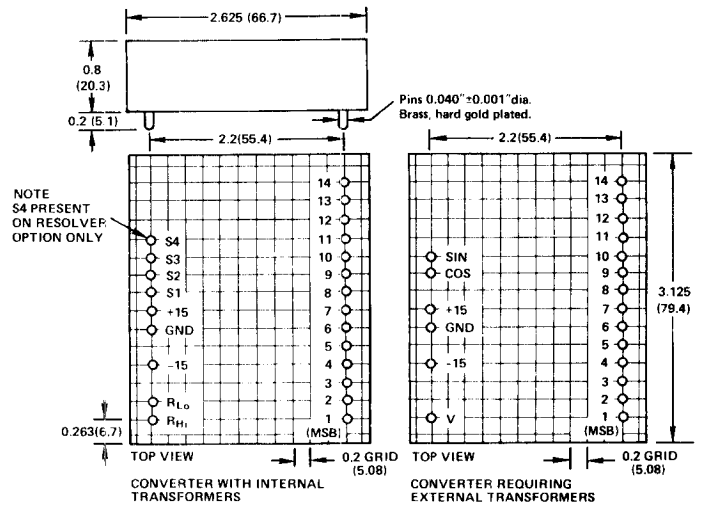

NOTE
DIAGRAMS ABOVE SHOW DSC1705.
DSC1706 DOES NOT HAVE PINS "13" AND "14".

TRANSFORMER (STM1679) OUTLINE DIMENSIONS AND PIN CONNECTION DIAGRAM

Dimensions shown in inches and (mm).

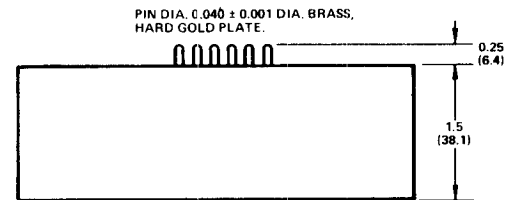
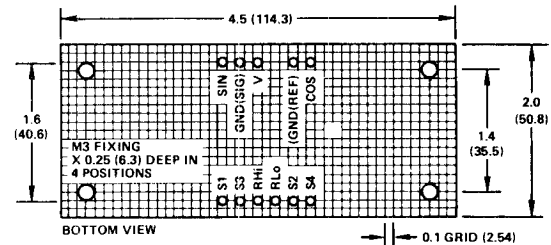

*S4 PIN PRESENT FOR RESOLVER OPTION ONLY

BIT WEIGHT TABLE

Bit Number	Weight in Degrees
1 (MSB)	180.0000
2	90.0000
3	45.0000
4	22.5000
5	11.2500
6	5.6250
7	2.8125
8	1.4063
9	0.7031
10	0.3516
11	0.1758
12 (LSB for DSC1706)	0.0879
13	0.0439
14 (LSB for DSC1705)	0.0220

LOADING THE DSC's WITH CONTROL TRANSFORMERS (CT's)

The most common device to be driven by Digital to Synchro converters is the control transformer (CT)

The minimum power required to drive a CT can be expressed as:

$$(VA) = \frac{V^2}{|Z_{SO}|} \cdot \frac{3}{4}$$

where V is the line to line voltage and Z_{SO} is the impedance between one input terminal and the other two shorted together with the rotor open circuit. ($Z_{SO} = R_{SO} + j X_{SO}$)

For example, if a CT has a Z_{SO} of $700 + j 4900$ and a line to line voltage of 90 volts, then:

$$|Z_{SO}| = \sqrt{700^2 + 4900^2} = 4950 \text{ Ohms}$$

$$\text{and } (VA) = \frac{90^2}{4950} \cdot \frac{3}{4} = 1.23VA$$

TUNING CT LOADS

The load can be reduced by tuning the output with 3 capacitors as shown below.

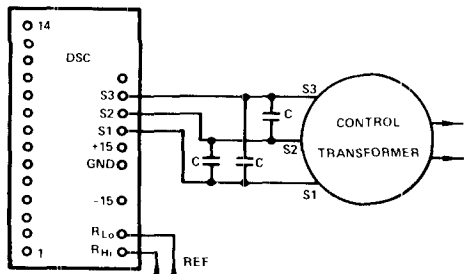

Capacitor Connection for Tuning CT's

C should be equal to:

$$\frac{X_{SO}}{2\omega (R_{SO}^2 + X_{SO}^2)}$$

The power required after tuning will be:

$$(VA)_{\text{untuned}} \times \frac{R_{SO}}{Z_{SO}}$$

Therefore in the above example the capacitor value should be:

$$\frac{4900}{2 \times 2\pi \times 400 (245 \times 10^5)} = 40nF$$

and the power required after tuning will be:

$$1.23 \times \frac{700}{4950} = 0.17VA$$

Note allowance should always be made for tolerances in the CT windings, capacitors and frequency.

PRACTICAL CONSIDERATIONS OF TUNING CT LOADS

1. The capacitors used need not be of high tolerance, 20% is sufficient.
2. Three capacitors must be used, one across S1 and S2, one across S1 and S3 and one across S2 and S3.
3. Voltage working and type of capacitors should be as follows:

11.8V Line-to-Line options:

15 Volt ac working or greater, non-polarized tantalum type.

90V Line-to-Line options:

100 Volt ac working or greater, for example, low K ceramic types.

4. For tuning Resolver loads, two capacitors only are required, one connected between S1 and S3 and the other connected between S2 and S4.

CONTROL DIFFERENTIAL TRANSMITTERS (CDX's)

The loading on a DSC of these devices can be considered in a similar way to that of CT's. However because a CT normally follows a CDX, the effective Z will need to be calculated. This value will normally be between 66% and 80% of the Z_{SO} quoted for the CDX.

TORQUE RECEIVERS (TR's)

Torque receivers are more difficult devices to drive than CT's and CDX's, and in general external amplifiers and transformers will be necessary. However, because of the lack of radius vector variation, the DSC1705 and DSC1706 are far more suited to driving TR's than converters with a variation of $\pm 7\%$.

For a deviation of an angle θ , the drive current required will be:

$$\frac{2 \cdot V \cdot \sin \frac{\theta}{2}}{|Z_{SS}|}$$

Points to be observed are:

- (a) The TR should not be allowed to lock up.
- (b) A phase lead equal to that specified for the TR should be introduced into the reference input to the DSC.
- (c) The reference should always be present on the TR and the converter.
- (d) The DSC output voltage should be matched exactly to the voltage requirements of the TR.

CAUTIONS

- (a) Do not connect a 115V reference to a 26V converter.
- (b) Do not reverse the power supplies.
- (c) Do not connect the reference to any other pins except "R_{Hi}" and "R_{Lo}"

ORDERING INFORMATION

When ordering, the converter part numbers should be suffixed by an option code in order to fully define the item. All standard options and their appropriate option codes are listed below.

Part Number ¹	Resolution	Operating Temp. Range	Line-to-Line Output Voltage and Format	Reference Voltage	Reference Frequency
DSC1705511	14 Bits	0 to +70°C	11.8V Synchro	26V	400Hz
DSC1705512	14 Bits	0 to +70°C	90.0V Synchro	115V	400Hz
DSC1705611	14 Bits	-55°C to +105°C	11.8V Synchro	26V	400Hz
DSC1705612	14 Bits	-55°C to +105°C	90.0V Synchro	115V	400Hz
DSC1705518	14 Bits	0 to +70°C	11.8V Resolver	26V	400Hz
DSC1705618	14 Bits	-55°C to +105°C	11.8V Resolver	26V	400Hz
DSC1705507 and STM1679522	14 Bits	0 to +70°C	90.0V Synchro	115V	60Hz
DSC1705607 and STM1679622	14 Bits	-55°C to +105°C	90.0V Synchro	115V	60Hz

- Note: 1. For 12 bit resolution, substitute DSC1706 in place of DSC1705 in the above.
2. For options not shown above, consult the factory.