

LM101A/301A General Purpose Operational Amplifier

GENERAL DESCRIPTION

The Intersil 101A and 301A are general purpose operational amplifiers. These high performance op amps are improved versions of the standard 101/301.

This general purpose op amp has many outstanding features; overload protection on the input and output, no latch-up when the common mode range is exceeded, and freedom from oscillations. The 101A also features better accuracy and lower noise in high impedance circuitry, and low input currents. Frequency compensation is achieved with a single 30 pF capacitor. It has advantages over internally compensated amplifiers in that the frequency compensation can be tailored to the particular application. For example, in low frequency circuits it can be overcompensated for increased stability margin. Or the compensation can be optimized to give more than a factor of ten improvement in high frequency performance for most applications.

The Intersil 101A operates over a temperature range from -55°C to +125°C while that of the 301A is 0°C to -70°C.

ABSOLUTE MAXIMUM RATINGS

Supply Voltage 101A	±22V
301A	±18V
Power Dissipation (Note 1)	500 mW
Differential Input Voltage	±30V
Input Voltage (Note 2)	±15V
Output Short-Circuit Duration	Indefinite
Operating Temperature Range 101A	-55°C to 125°C
301A	0°C to 70°C
Storage Temperature Range	-65°C to 150°C
Lead Temperature (Soldering, 60 sec)	300°C

NOTE 1: The maximum junction temperature of the 101A is 150°C, while that of the 301A is 100°C. For operating at elevated temperatures devices in the TO-5 package must be derated based on a thermal resistance of 150°C/W, junction to ambient or 45°C/W, junction to case. For the flat package, the derating is based on thermal resistance of 185°C/W when mounted on a 1-16-inch-thick epoxy glass board with ten 0.03-inch-wide, 2-ounce copper conductors. The thermal resistance of the dual-in-line package is 100°C/W, junction to ambient.

NOTE 2: For supply voltages less than ±15V, the absolute maximum input voltage is equal to the supply voltage.

5

ORDERING INFORMATION

Part Number	8 lead TO-99	8 pin Plastic DIP	10 lead Flatpak	14 pin CER DIP	14 pin Plastic DIP	Dice
101A	LM101AH*		LM101AF*	LM101AJ-14		LM101A/D
301A	LM301AH	LM301AN	LM301AF	LM301AJ	LM301AN-14	LM301A/D

* Add/883B to ordering number if 883B processing is desired.

PIN CONFIGURATIONS

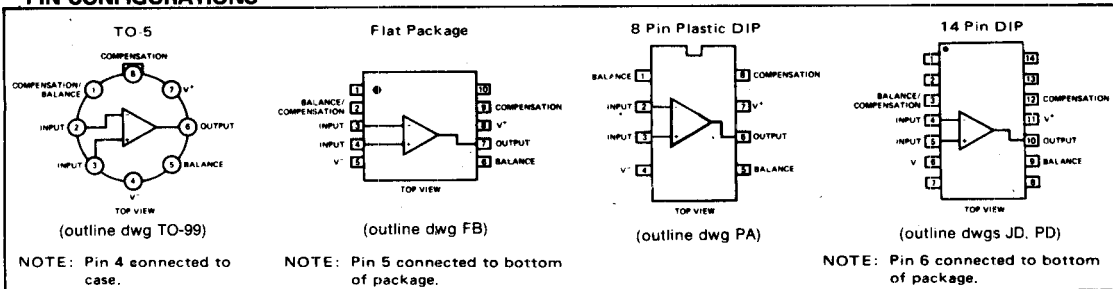

ELECTRICAL CHARACTERISTICS (Note)

PARAMETER	CONDITIONS	101A			301A			UNITS
		MIN	TYP	MAX	MIN	TYP	MAX	
Input Offset Voltage	$T_A = 25^\circ\text{C}, R_S \leq 50\text{ k}\Omega$		0.7	2.0		2.0	7.5	mV
Input Offset Current	$T_A = 25^\circ\text{C}$		1.5	10		3	50	nA
Input Bias Current	$T_A = 25^\circ\text{C}$		30	75		70	250	nA
Input Resistance	$T_A = 25^\circ\text{C}$	1.5	4		0.5	2		M Ω
Supply Current	$T_A = 25^\circ\text{C}, V_S = \pm 20\text{V}$ $T_A = 25^\circ\text{C}, V_S = \pm 15\text{V}$		1.8	3.0		1.8	3.0	mA mA
Large Signal Voltage Gain	$T_A = 25^\circ\text{C}, V_S = \pm 15\text{V}$ $V_{\text{OUT}} = \pm 10\text{V}, R_L \geq 2\text{ k}\Omega$	50	160		25	160		V/mV
Input Offset Voltage	$R_S \leq 50\text{ k}\Omega$			3.0			10	mV
Average Temperature Coefficient of Input Offset Voltage			3.0	15		6.0	30	$\mu\text{V}/^\circ\text{C}$
Input Offset Current				20			70	nA
Average Temperature Coefficient of Input Offset Current	$25^\circ\text{C} \leq T_A \leq 125^\circ\text{C}$ $25^\circ\text{C} \leq T_A \leq 70^\circ\text{C}$ $-55^\circ\text{C} \leq T_A \leq 25^\circ\text{C}$ $0^\circ\text{C} \leq T_A \leq 25^\circ\text{C}$		0.01	0.1		0.01	0.3	nA/ $^\circ\text{C}$ nA/ $^\circ\text{C}$ nA/ $^\circ\text{C}$ nA/ $^\circ\text{C}$
Input Bias Current				100			300	nA
Supply Current	$T_A = +125^\circ\text{C}, V_S = \pm 20\text{V}$		1.2	2.5				mA
Large Signal Voltage Gain	$V_S = \pm 15\text{V}, V_{\text{OUT}} = \pm 10\text{V}$ $R_L \geq 2\text{ k}\Omega$	25			15			V/mV
Output Voltage Swing	$V_S = \pm 15\text{V}, R_L = 10\text{ k}\Omega$ $R_L = 2\text{ k}\Omega$	± 12 ± 10	± 14 ± 13		± 12 ± 10	± 14 ± 13		V V
Input Voltage Range	$V_S = \pm 20\text{V}$ $V_S = \pm 15\text{V}$	± 15			± 12			V V
Common Mode Rejection Ratio	$R_S \leq 50\text{ k}\Omega$	80	96		70	90		dB
Supply Voltage Rejection Ratio	$R_S \leq 50\text{ k}\Omega$	80	96		70	96		dB

NOTE: For the 101A, these specifications apply for $\pm 5\text{V} < V_S < \pm 20\text{V}$ and $-55^\circ\text{C} \leq T_A \leq 125^\circ\text{C}$ unless otherwise specified.
For the 301A, these specifications apply for $\pm 5\text{V} \leq V_S \leq \pm 15\text{V}$ and $0^\circ\text{C} \leq T_A \leq 70^\circ\text{C}$, unless otherwise specified.

GUARANTEED PERFORMANCE *

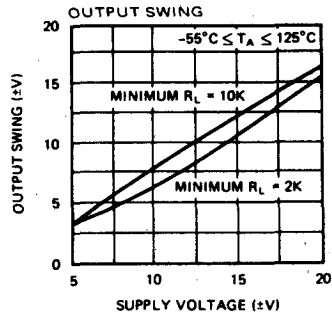
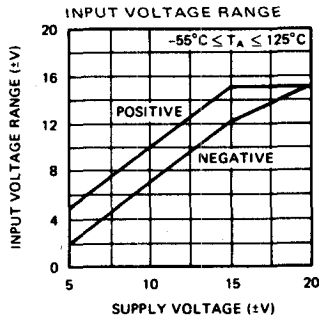

TYPICAL PERFORMANCE *

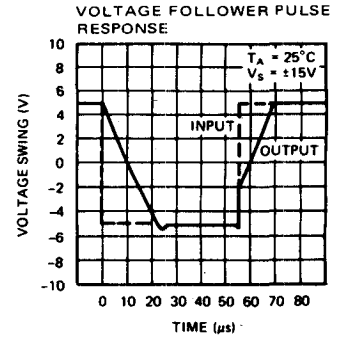
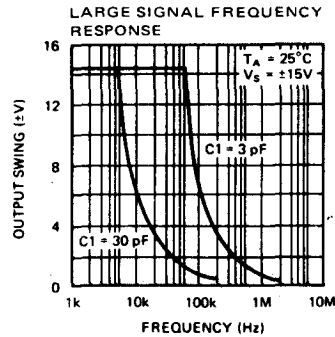
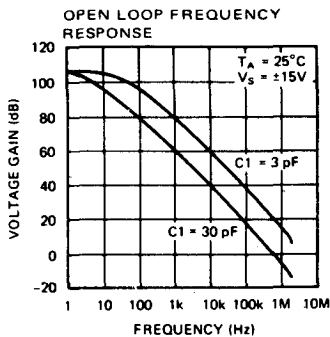
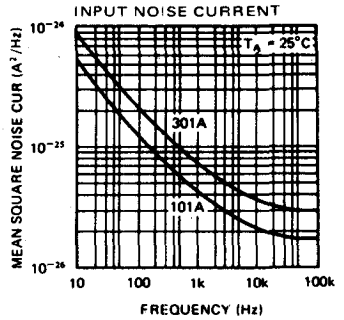
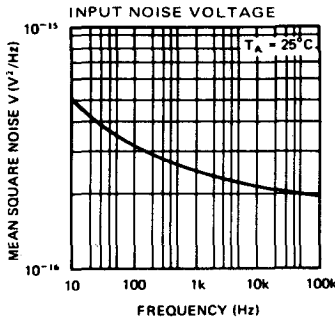
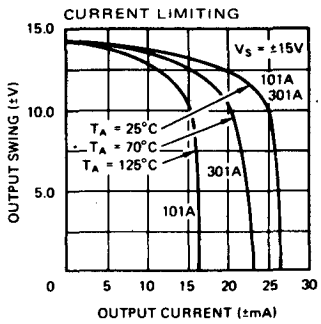
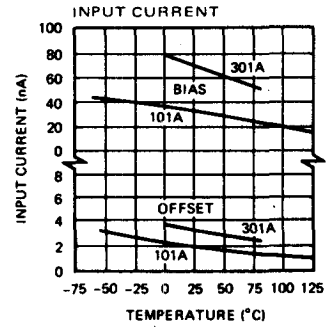
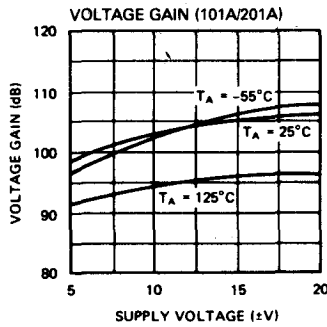
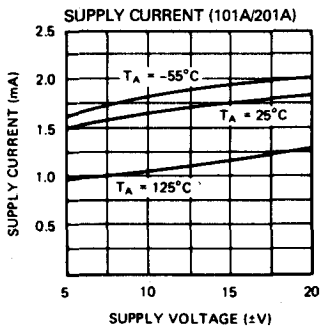

*301A only guaranteed to ±15V, 0°C ≤ TA ≤ 70°C.



EQUIVALENT SCHEMATIC DIAGRAM

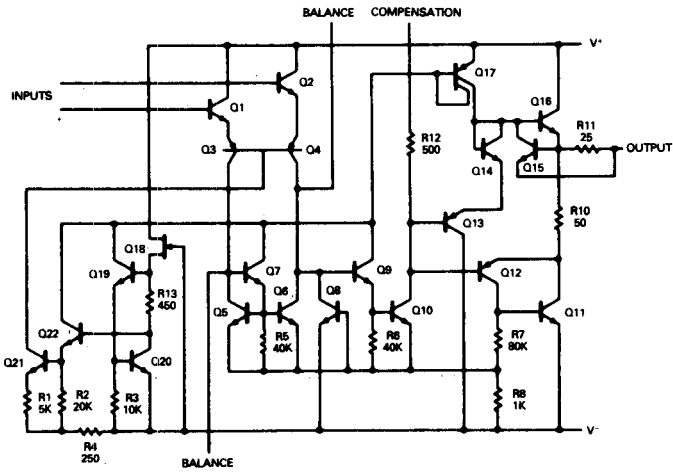

5

TYPICAL APPLICATIONS

Fast Voltage Follower

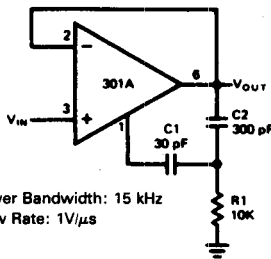

Standard Compensation and Offset Balancing Circuit

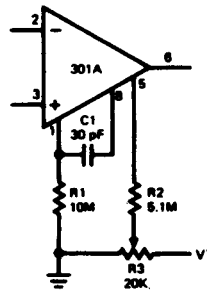

Fast Summing Amplifier

