

DG139, DG142 — DG146, DG161 — DG164 Drivers with Differentially Driven N.O. and N.C. FET Switches

FEATURES

- Each channel complete-interfaces with most integrated logic
- Low OFF power dissipation, 1 mW
- Switches analog signals up to 20 volts peak-to-peak
- Low $r_{DS(ON)}$, 10 ohms max on DG145 and DG146

GENERAL DESCRIPTION

Each package contains a monolithic driver with differential input and 2 or 4 discrete FET switches. The driver may be treated as a special purpose differential amplifier which controls the conduction state of the FET switches. The differential output of the driver sets the switches in opposition, one pair open and the other pair closed. All switches may be opened by applying a positive control signal to the V_R terminal.

3

SCHEMATIC AND LOGIC DIAGRAMS (Outline Dwgs DD, FD-2, JD)

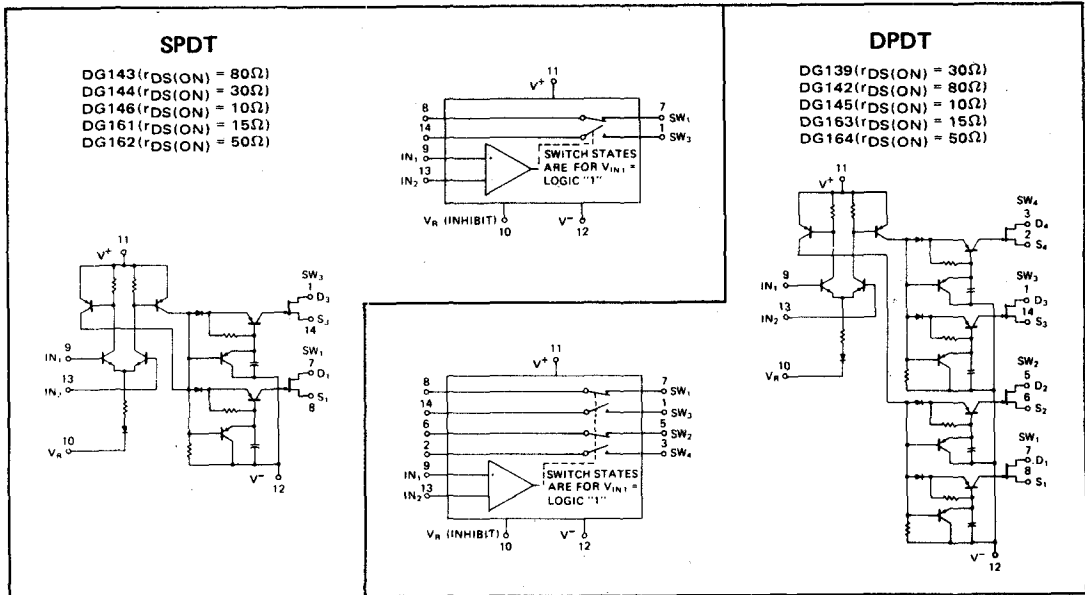

ORDERING INFORMATION

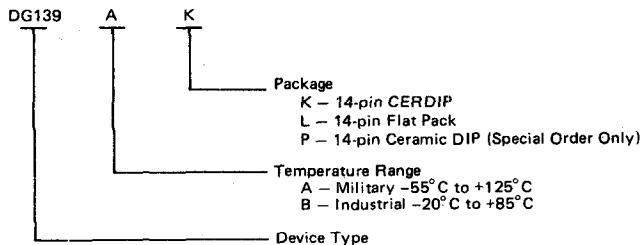

ABSOLUTE MAXIMUM RATINGS

$V^+ - V^-$	36V	$V^+ - V_R$	17V
$V_S - V^-$	30V	$V^+ - V_{IN1}$ or V_{IN2}	14V
$V^+ - V_S$	30V	$V_{IN1} - V_{IN2}$	$\pm 6V$
$V_S - V_D$	$\pm 22V$	$V_{IN1} - V_R$	$\pm 6V$
$V_R - V^-$	21V	$V_{IN2} - V_R$	$\pm 6V$
Power Dissipation (Note)	750 mW		
Current (any terminal)	30 mA		

Storage Temperature	-65 to +150°C
Operating Temperature	-55 to +125°C
Lead Temperature (soldering, 10 sec)	300°C

NOTE: Dissipation rating assumes device is mounted with all leads welded or soldered to printed circuit board in ambient temperature below 70°C. For higher temperature, derate at rate of 10 mW/°C.

Stresses above those listed under Absolute Maximum Ratings may cause permanent damage to the device. These are stress ratings only, and functional operation of the device at these or any other conditions above those indicated in the operational sections of the specifications is not implied. Exposure to absolute maximum rating conditions for extended periods may affect device reliability.

ELECTRICAL CHARACTERISTICS

3

Applied voltages for all tests: DG139, DG142, DG143, DG144, DG145, DG146 ($V^+ = 12V$, $V^- = -18V$, $V_R = 0$, $V_{IN2} = 2.5V$) and DG161, DG162, DG163, DG164 ($V^+ = 15V$, $V^- = -15V$, $V_R = 0$, $V_{IN2} = 2.5V$). Input test condition that guarantees FET switch ON or OFF as specified is used for output specifications.

	SYMBOL (NOTE)	CHARACTERISTIC	TYPE	ABSOLUTE MAX. LIMIT			UNITS	TEST CONDITIONS	
				-55°	25°	125°			
I N P U T	$V_{IN(ON)}$	Input Voltage—On	All Circuits	2.9 min	2.5 min	2.0 min	Volts	At Pin 9 and 13 See Figure 1 and 2, Pg. 4	
	$V_{IN(OFF)}$	Input Voltage—Off		1.4	1.0	0.6	Volts	At Pin 9 and 13 See Figure 1 and 2, Pg. 4	
	$ V_B - V_{I3} $	Differential Voltage		0.5 min	0.5 min	0.5 min	Volts	See Note 1, Pg. 4	
	$I_{IN(ON)}$	Input Current		120	60	60	μA	$V_{IN1} = 3.0V$	
	$I_{IN2(ON)}$			120	60	60	μA	$V_{IN2} = 2.0V$	
	$I_{IN1(OFF)}$	Input Leakage Current		0.1	0.1	2	μA	$V_{IN1} = 2.0V$	
$I_{IN2(OFF)}$	0.1		0.1	2	μA	$V_{IN2} = 3.0V$			
S W I T C H O U T P U T	$r_{DS(ON)}$	Drain-Source On Resistance	DG142 DG143	80	80	150	Ω	$V_D = 10V, I_S = -1mA$	
			DG139 DG144	30	30	60	Ω		
			DG145 DG146	10	10	20	Ω		
			DG161 DG163	15	15	30	Ω		
			DG162 DG164	50	50	100	Ω		
							Ω		$V_D = 7.5V, I_S = 1mA$
		$I_{D(ON)} + I_{S(ON)}$	Drive Leakage Current	DG139		2	100	nA	$V_D = V_S = -10V$
		$I_{S(OFF)}$	Source Leakage Current	DG142		1	100	nA	$V_S = 10V, V_D = -10V$
		$I_{D(OFF)}$	Drain Leakage Current	DG143		1	100	nA	$V_D = 10V, V_S = -10V$
		$I_{D(ON)} + I_{S(ON)}$	Drive Leakage Current	DG144		1	100	nA	$V_D = 10V, V_S = -10V$
		$I_{D(ON)} + I_{S(ON)}$	Drive Leakage Current	DG145		2	100	nA	$V_D = V_S = -10V$
		$I_{S(OFF)}$	Source Leakage Current	DG146		10	1000	nA	$V_S = 10V, V_D = -10V$
		$I_{D(OFF)}$	Drain Leakage Current	DG146		10	1000	nA	$V_D = 10V, V_S = -10V$
		$I_{D(ON)} + I_{S(ON)}$	Drive Leakage Current	DG161		2	500	nA	$V_D = V_S = -7.5V$
	$I_{S(OFF)}$	Source Leakage Current	DG163		10	1000	nA	$V_S = 7.5V, V_D = -7.5V$	
	$I_{D(OFF)}$	Drain Leakage Current	DG163		10	1000	nA	$V_D = 7.5V, V_S = -7.5V$	
	$I_{D(ON)} + I_{S(ON)}$	Drive Leakage Current	DG162		2	500	nA	$V_D = V_S = -7.5V$	
	$I_{S(OFF)}$	Source Leakage Current	DG164		2	200	nA	$V_S = 7.5V, V_D = -7.5V$	
	$I_{D(OFF)}$	Drain Leakage Current	DG164		2	200	nA	$V_D = 7.5V, V_S = -7.5V$	
P O W E R S U P P L Y	$I_{1(ON)}$	Positive Power Supply Drain Current	All Circuits		4.0		mA	$V_{IN1} = 3V$ or $V_{IN1} = 2V$	
	$I_{2(ON)}$	Negative Power Supply Drain Current			-2.0		mA		
	$I_{R(ON)}$	Reference Power Supply Drain Current			-2.0		mA		
	$I_{1(OFF)}$	Positive Power Supply Leakage Current				25		μA	$V_{IN1} = V_{IN2} = 0.8V$
	$I_{2(OFF)}$	Negative Power Supply Leakage Current				-25		μA	
	$I_{R(OFF)}$	Reference Power Supply Leakage Current				-25		μA	

NOTE: (OFF) and (ON) subscript notation refers to the conduction state of the FET switch for the given test.

ELECTRICAL CHARACTERISTICS PER CHANNEL (cont.)

SYMBOL (NOTE)	CHARACTERISTIC	TYPE	ABSOLUTE MAX. LIMIT			UNITS	TEST CONDITIONS
			-55°C	25°	125°		
t _{ON}	Turn-On Time	DG139, DG142 DG143, DG144 DG162, DG164		0.8		μs	See Below
		DG139, DG142 DG143, DG144 DG162, DG164		0.4	0.7	μs	
t _{OFF}	Turn-Off Time	DG139, DG142 DG143, DG144 DG162, DG164		1.6		μs	See Below
		DG139, DG142 DG143, DG144 DG162, DG164		0.8	1.2	μs	
t _{ON}	Turn-On Time	DG145, DG146 DG161, DG163		1.0		μs	See Below
		DG145, DG146 DG161, DG163		0.5	0.8	μs	
t _{OFF}	Turn-Off Time	DG145, DG146 DG161, DG163		2.5		μs	See Below
		DG145, DG146 DG161, DG163		1.25	1.8	μs	
P _{ON}	ON Driver Power	All Circuits		175		mW	Both Inputs V _{IN} = 2.5V
P _{OFF}	OFF Driver Power			1		mW	Both Inputs V _{IN} = 1.0V

3

NOTE: (OFF) and (ON) subscript notation refers to the conduction state of the FET switch for the given test.

SWITCHING TIMES (25°C)

DG139, 142, 143, 144, 145, 146

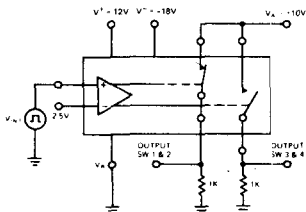
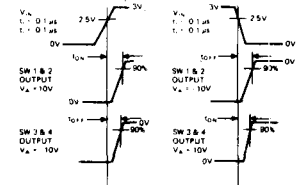

OFF MODEL

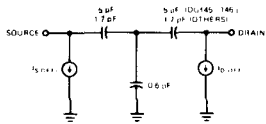

ON MODEL

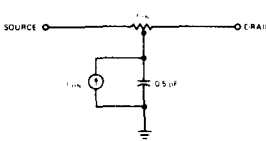

DG161, 162, 163, 164

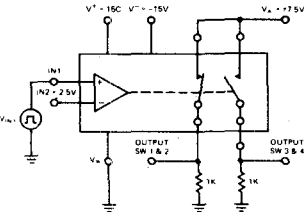
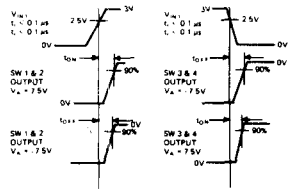

OFF MODEL

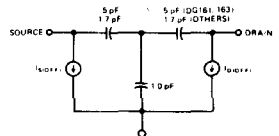

ON MODEL

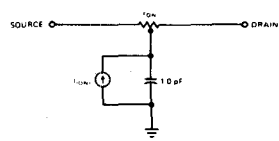

FIGURE 1

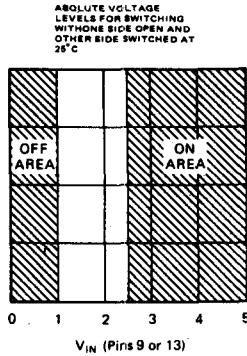
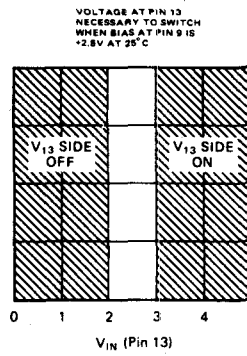

FIGURE 2



3

NOTE1: An example of Absolute Minimum Differential Voltage, $|V_9 - V_{13}|$, is when $V_9 = 3V$ and $V_{13} = 2.5V$, the V_9 side of the switch is ON and the V_{13} side of the switch is OFF at 25°C. Conversely, when $V_9 = 2V$ and $V_{13} = 2.5V$, the V_9 side of the switch is OFF and the V_{13} side of the switch is ON at 25°C.

TYPICAL CHARACTERISTICS (per channel)

DG139, 142, 144, 145, 146

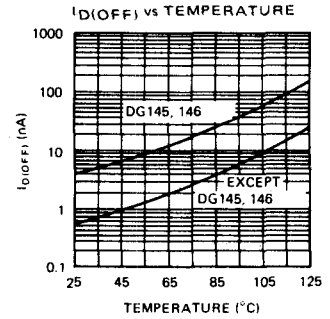
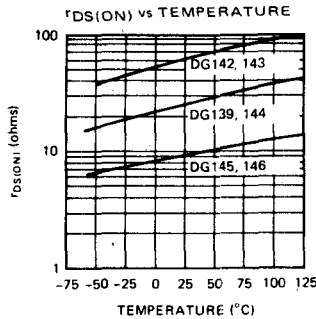
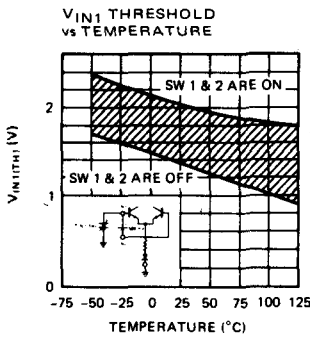

DG161, 162, 163, 164

