

HA 2500/02/05/10/12/15/20/22/25 High Slew Rate Operational Amplifiers

FEATURES

- Slew Rate – Up to 120 V/ μ s
- Settling Time – 200 ns to 0.1%
- Bias Current – 100 nA
- Gain Bandwidth Product – 30 MHz
- Internal Frequency Compensation
- Radiation Hardened
- Meets MIL-STD-883

GENERAL DESCRIPTION

The 2500 series of high slew rate operational amplifiers are monolithic integrated circuits fabricated using dielectric isolation and thin film resistors. These internally compensated amplifiers feature excellent input parameters, high gain and wide bandwidth. They are ideally suited for D/A and A/D converter circuits, pulse amplifiers and high frequency buffer amplifiers.

2500 through 2515 are compensated for unity gain. 2520 through 2525 are intended for closed loop gains of 3 or greater, and feature increased slew rates and gain-bandwidth products.

VOLTAGE OFFSET NULL CIRCUIT

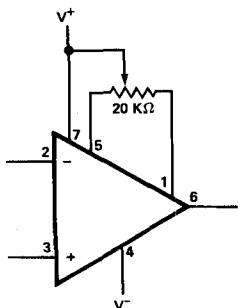

PIN CONFIGURATIONS

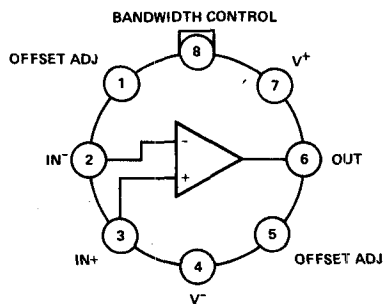

(TOP VIEW)
(outline dwg TO-99)

ORDERING INFORMATION

PART NUMBER	TEMPERATURE RANGE	PACKAGE TYPE	ORDER NUMBER
HA2500	-55°C to +125°C	TO-99 Flat Pack	HA2-2500-2 * HA9-2500-2 *
HA2502	-55°C to +125°C	TO-99 Flat Pack	HA2-2502-2 * HA9-2502-2 *
HA2505	0°C to +75°C	TO-99 Flat Pack	HA2-2505-5 HA9-2505-5
HA2510	-55°C to +125°C	TO-99 Flat Pack	HA2-2510-2 * HA9-2510-2 *
HA2512	-55°C to +125°C	TO-99 Flat Pack	HA2-2512-2 * HA9-2512-2 *
HA2515	0°C to +75°C	TO-99 Flat Pack	HA2-2515-5 HA9-2515-5
HA2520	-55°C to +125°C	TO-99 Flat Pack	HA2-2520-2 * HA9-2520-2 *
HA2522	-55°C to +125°C	TO-99 Flat Pack	HA2-2522-2 * HA9-2522-2 *
HA2525	0°C to +75°C	TO-99 Flat Pack	HA2-2525-5 HA9-2525-5

*883 processing is available for these devices.
Order -8 instead of -2.

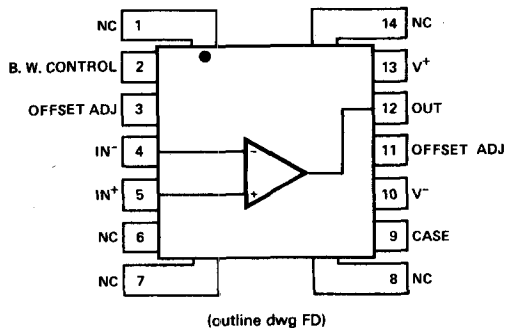

(outline dwg FD)

5

ABSOLUTE MAXIMUM RATINGS

Supply Voltage	±20V
Input Voltage (Note 1)	±15V
Differential Input Voltage	±15V
Peak Output Current	±50 mA
Internal Power Dissipation (Note 2)	300 mW
Lead Temperature (Soldering, 60 sec)	300°C
Storage Temperature Range	-65°C to +150°C
Operating Temperature Range	-55°C to +125°C (2500, 2502) 0°C to +75°C (2505)

ELECTRICAL CHARACTERISTICS (T_A = 25°C, V_S = ±15V unless otherwise specified)

PARAMETER	CONDITIONS	2500			2502			2505			UNITS
		MIN	TYP	MAX	MIN	TYP	MAX	MIN	TYP	MAX	
Input Offset Voltage	R _S ≤ 10 kΩ		2	5		4	8		4	8	mV
Input Offset Current			10	25		20	50		20	50	nA
Input Resistance		25	50		20	50		20	50		MΩ
Large Signal Voltage Gain	R _L = 2kΩ, V _O = ±10V	20k	30k		15k	25k		15k	25k		V/V
Gain Bandwidth	A _V > 10		12			12			12		MHz
Full Power Bandwidth	R _L = 2kΩ, C _L = 50pF, V _O = 20V _{p-p}	350	500		300	500		300	500		kHz
Rise Time (Notes 3,4)	R _L = 2kΩ, C _L = 50pF		25	50		25	50		25	50	ns
Overshoot (Notes 3,4)	R _L = 2kΩ, C _L = 50pF		25	40		25	50		25	50	%
Slew Rate (Note 3)	R _L = 2kΩ, C _L = 50pF, V _O = ±5V	±25	±30		±20	±30		±20	±30		V/μs
Settling Time (to 0.1% of Final Value) (Note 3)	R _L = 2kΩ, C _L = 50pF, V _O = ±5V		330			330			330		ns
Output Current	V _O = ±10V	±10			±10			±10			mA
Supply Current			4	6		4	6		4	6	mA

5

THE FOLLOWING SPECIFICATIONS APPLY FOR OPERATING TEMPERATURE RANGE

Input Offset Voltage	R _S ≤ 10 kΩ			8			10			10	mV
Input Offset Current				50			100			100	nA
Input Bias Current	+25°C to +125°C		100	200		125	250				nA
	-55°C to +25°C		200	400		250	500				nA
	+25°C to +75°C							125	250		nA
	0°C to +25°C							250	500		nA
Offset Voltage Average Drift	R _S ≤ 10 kΩ		20			20			20		μV/°C
Offset Current Average Drift			0.1			0.1			0.1		nA/°C
Common Mode Rejection Ratio	V _{CM} = ±5V	80	90		74	90		74	90		dB
Common Mode Range		±10			±10			±10			V
Supply Voltage Rejection Ratio	ΔV = ±5V	80	90		74	90		74	90		dB
Large Signal Voltage Gain	R _L = 2kΩ, V _O = ±10V	7.5k			5k			10k			V/V
Output Voltage Swing	R _L = 2kΩ	±10	±12		±10	±12		±10	±12		V

NOTE 1: For supply voltages less than ±15V, the absolute maximum input voltage is equal to the supply voltage.

NOTE 2: Derate TO-86 at 4.5 mW/°C above 84°C; derate TO-99 at 6.6 mW/°C above 105°C.

NOTE 3: A_V = 1.

NOTE 4: V_O = 400 mV_{p-p}.

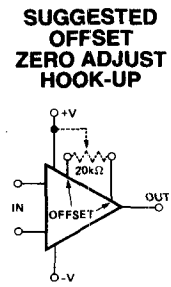
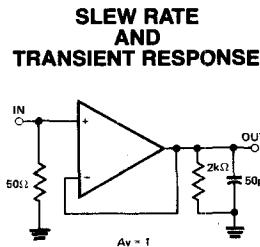
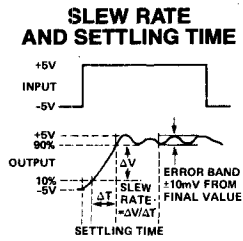
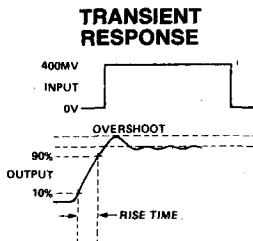

NOTE: Measured on both positive and negative transitions.

ABSOLUTE MAXIMUM RATINGS

Supply Voltage	±20V
Input Voltage (Note 1)	±15V
Differential Input Voltage	±15V
Peak Output Current	±50 mA
Internal Power Dissipation (Note 2)	300 mW
Lead Temperature (Soldering, 60 sec)	300°C
Storage Temperature Range	-65°C to +150°C
Operating Temperature Range	-55°C to +125°C (2510, 2512) 0°C to +75°C (2515)

ELECTRICAL CHARACTERISTICS (T_A = 25°C, V_S = ±15V unless otherwise specified)

PARAMETER	CONDITIONS	2510			2512			2515			UNITS
		MIN	TYP	MAX	MIN	TYP	MAX	MIN	TYP	MAX	
Input Offset Voltage	R _S ≤ 10 kΩ		4	8		5	10		5	10	mV
Input Offset Current			10	25		20	50		20	50	nA
Input Resistance		50	100		40	100		40	100		MΩ
Large Signal Voltage Gain	R _L = 2 kΩ, V _O = ±10V	10k	15k		7.5k	15k		7.5k	15k		V/V
Gain Bandwidth	A _V > 10		12		12			12			MHz
Full Power Bandwidth	R _L = 2kΩ, C _L = 50pF, V _O = 20Vp-p	750	1000		600	1000		600	1000		kHz
Rise Time (Notes 3,4)	R _L = 2kΩ, C _L = 50pF		25	50		25	50		25	50	ns
Overshoot (Notes 3,4)	R _L = 2kΩ, C _L = 50pF		25	40		25	50		25	50	%
Slew Rate (Note 3)	R _L = 2kΩ, C _L = 50pF, V _O = ±5V	±50	±65		±40	±60		±40	±60		V/μs
Settling Time (to 0.1% of Final Value) (Note 3)	R _L = 2kΩ, C _L = 50pF, V _O = ±5V		250			250		250			ns
Output Current	V _O = ±10V		±10			±10			±10		mA
Supply Current			4	6		4	6		4	6	

5

THE FOLLOWING SPECIFICATIONS APPLY FOR OPERATING TEMPERATURE RANGE

Input Offset Voltage	R _S ≤ 10 kΩ			11		14			14	mV
Input Offset Current				50		100			100	nA
Input Bias Current	+25°C to +125°C		100	200		125	250			nA
	-55°C to +25°C		200	400		250	500			nA
	+25°C to +75°C							125	250	nA
	0°C to +25°C							250	500	nA
Offset Voltage Average Drift	R _S ≤ 10 kΩ		20			30			30	μV/°C
Offset Current Average Drift			0.1			0.1			0.1	nA/°C
Common Mode Rejection Ratio	V _{CM} = ±5V	80	90		74	90		74	90	dB
Common Mode Range			±10			±10			±10	V
Supply Voltage Rejection Ratio	ΔV = ±5V	80	90		74	90		74	90	dB
Large Signal Voltage Gain	R _L = 2kΩ, V _O = ±10V	7.5k			5k			5k		V/V
Output Voltage Swing	R _L = 2kΩ	±10	±12		±10	±12		±10	±12	V

NOTE 1: For supply voltages less than ±15V, the absolute maximum input voltage is equal to the supply voltage.

NOTE 2: Derate TO-86 at 4.5 mW/°C above 84°C; derate TO-99 at 6.6 mW/°C above 105°C.

NOTE 3: A_V = 1.

NOTE 4: V_O = 400 mV_{p-p}.

TRANSIENT RESPONSE

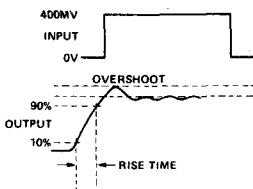

SLEW RATE AND SETTLING TIME

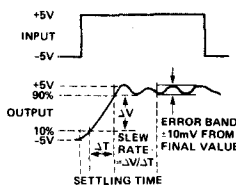

SLEW RATE AND TRANSIENT RESPONSE

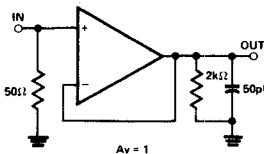

SUGGESTED OFFSET ZERO ADJUST HOOK-UP

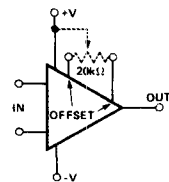

NOTE: Measured on both positive and negative transitions.

ABSOLUTE MAXIMUM RATINGS

Supply Voltage	±20V
Input Voltage (Note 1)	±15V
Differential Input Voltage	±15V
Peak Output Current	±50 mA
Internal Power Dissipation (Note 2)	300 mW
Lead Temperature (Soldering, 60 sec.)	300°C
Storage Temperature Range	-65°C to +150°C
Operating Temperature Range	-55°C to +125°C (2520, 2522) 0°C to +75°C (2525)

ELECTRICAL CHARACTERISTICS (T_A = 25°C, V_S = ±15V unless otherwise specified)

PARAMETER	CONDITIONS	2520			2522			2525			UNITS
		MIN	TYP	MAX	MIN	TYP	MAX	MIN	TYP	MAX	
Input Offset Voltage	R _S ≤ 10 kΩ		4	8		5	10		5	10	mV
Input Offset Current			10	25		20	50		20	50	nA
Input Resistance		50	100		40	100		40	100		MΩ
Large Signal Voltage Gain	R _L = 2 kΩ, V _O = ±10V	10k	15k		7.5k	15k		7.5k	15k		V/V
Gain Bandwidth	A _V > 10		30		30			30			MHz
Full Power Bandwidth	R _L = 2 kΩ, C _L = 50pF, V _O = 20Vp-p	1500	2000		1200	1600		1200	1600		kHz
Rise Time (Notes 3,4)	R _L = 2kΩ, C _L = 50pF		15	50		15	50		15	50	ns
Overshoot (Notes 3,4)	R _L = 2 kΩ, C _L = 50pF		25	40		25	50		25	50	%
Slew Rate (Note 3)	R _L = 2 kΩ, C _L = 50pF, V _O = ±5V	±100	±120		±80	±120		±80	±120		V/μs
Settling Time (to 0.1% of Final Value) (Note 3)	R _L = 2kΩ, C _L = 50pF, V _O = ±5V		200			200			200		ns
Output Current	V _O = ±10V	±10			±10			±10			mA
Supply Current			4	6		4	6		4	6	mA

5

THE FOLLOWING SPECIFICATIONS APPLY FOR OPERATING TEMPERATURE RANGE

Input Offset Voltage	R _S ≤ 10 kΩ			11			14			14	mV
Input Offset Current				50			100			100	nA
Input Bias Current	+25°C to +125°C		100	200		125	250				nA
	-55°C to +25°C		200	400		250	500				nA
	+25°C to +75°C							125	250		nA
	0°C to +25°C							250	500		nA
Offset Voltage Average Drift	R _S ≤ 10 kΩ		20			30			30		μV/°C
Offset Current Average Drift			0.1			0.1			0.1		nA/°C
Common Mode Rejection Ratio	V _{CM} = ±5V	80	90		74	90		74	90		dB
Common Mode Range		±10			±10			±10			V
Supply Voltage Rejection Ratio	ΔV = ±5V	80	90		74	90		74	90		dB
Large Signal Voltage Gain	R _L = 2 kΩ, V _O = ±10V		7.5k			5k			5k		V/V
Output Voltage Swing	R _L = 2 kΩ	±10	±12		±10	±12		±10	±12		V

NOTE 1: For supply voltage less than ±15V, the absolute maximum input voltage is equal to the supply voltage.

NOTE 2: Derate TO-86 at 4.5 mW/°C above 84°C; derate TO-99 at 6.6 mW/°C above 105°C.

NOTE 3: A_V = 3.

NOTE 4: V_O = 600 mVp-p.

TRANSIENT RESPONSE

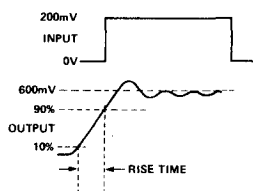

SLEW RATE

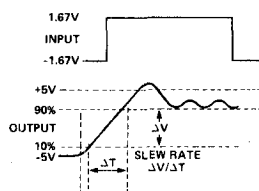

SLEW RATE AND TRANSIENT RESPONSE

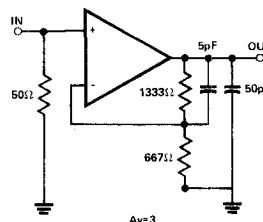

SUGGESTED OFFSET ZERO ADJUST AND BANDWIDTH CONTROL HOOK-UP

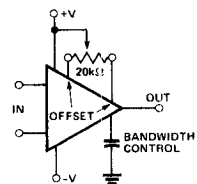

NOTE: Measured on both positive and negative transients.

SCHEMATIC DIAGRAM

