



For use with TO-5 packages

322505b00000

VIS#000532



Mechanical Outline Drawing

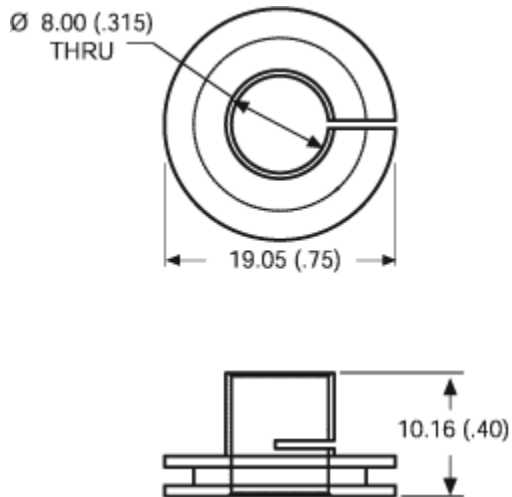

Thermal Resistance	40.0
---------------------------	------

Thermal resistance value is based on a
75°C rise in natural convection

Thermal Curves

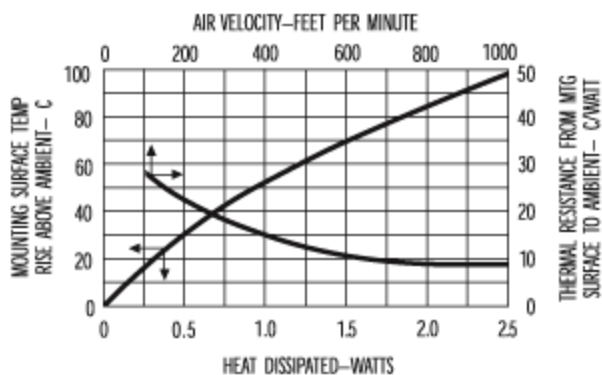

Product Information

12 Digit Part #	Description	Finish	Board Mounting
322505b00000	Heat Sink with no added hardware	Black Anodize	N/A

Not Exactly what you need?

We offer several options for those applications which require a more unique solution. For slight modifications of this part or other attachment options, finishes, and interface materials, contact your [local representative](#). Challenge us with your thermal requirements - we can design custom solutions.

For technical help with our Standard Products,
 please call (603) 223-1921, or contact your local Manufacturer's Rep
 Email: info@aavid.com

Visit us at www.aavidthermalloy.com • ©2002 Aavid Thermalloy, LLC