

### FEATURES

- Low  $V_{OS}$ ..... 75 $\mu$ V Max
- Low  $V_{OS}$  Drift..... 1.3 $\mu$ V/ $^{\circ}$ C Max
- Ultra Stable with Time..... 1.5 $\mu$ V/Month Max
- Low Noise .....0.6 $\mu$ V<sub>P-P</sub> Max
- Wide Input Voltage Range .....  $\pm$ 14V
- Wide Supply Voltage Range .....  $\pm$ 3V to  $\pm$ 18V

### APPLICATIONS

- High-Gain Instrumentation
- Precision Data Acquisition
- Precision Integrators
- Precision Threshold Detectors
- Biomedical Amplifiers

### GENERAL DESCRIPTION

The AMSOP-07 is a precision operational amplifier with a very low input offset voltage. This device features a wide input voltage range of  $\pm$ 13V minimum, low input bias current, high impedance, high CMRR, excellent stability of offsets and gain over time and temperature. Excellent linearity can be maintained even at high closed-loop gains.

Low cost, low noise, low offsets and high open-loop gain make the AMSOP-07 an excellent choice particularly for high-gain instrumentation applications. Other applications include precision data acquisition, precision integrators, threshold detectors and medical instrumentation.

The AMSOP-07 is operational in the full industrial temperature range of  $-40^{\circ}$ C to  $85^{\circ}$ C and is available in the 8 lead SOIC and plastic dip (PDIP) packages.

### ORDERING INFORMATION:

TOL.	PACKAGE TYPE		OPERATING TEMPERATURE RANGE
	8 LEAD SOIC	8 LEAD PDIP	
$\pm$ 75 $\mu$ V	AMSOP-07ES	AMSOP-07EP	$-40$ to $85^{\circ}$ C
$\pm$ 150 $\mu$ V	AMSOP-07CS	AMSOP-07CP	$-40$ to $85^{\circ}$ C
$\pm$ 150 $\mu$ V	AMSOP-07DS	AMSOP-07DP	$-40$ to $85^{\circ}$ C

### PIN CONNECTIONS

#### 8 Lead SOIC/ 8Lead PDIP

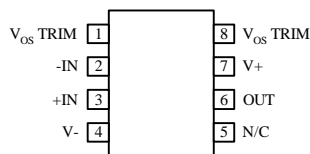

Top View

# AMSOP-07

## ABSOLUTE MAXIMUM RATINGS (Note1)

Supply Voltage	±22V	Storage temperature	-65°C to +125°C
Differential Input Voltage	±30V	Junction Temperature	+150°C
Input Voltage	±22V	Soldering information (60 sec)	300°C
Output Short Circuit Duration	Indefinite	Thermal Resistance	
Operating Temperature Range	-40°C to 85°C	8 L SOIC	158°C/W
		8 L PDIP	103°C/W

## ELECTRICAL CHARACTERISTICS

Electrical Characteristics at  $V_{IN} = \pm 15V$  and  $T_A = +25^\circ C$  unless otherwise specified.

Parameter	Conditions	AMSOP-07E			AMSOP-07 C			AMSOP-07 D			Units
		Min	Typ	Max	Min	Typ	Max	Min	Typ	Max	
Input Offset Voltage	(Note 2)		30	75		60	150		60	150	$\mu V$
Long Term $V_{OS}$ Stability	(Note 3)		0.3	1.5		0.4	2.0		0.5	3.0	$\mu V/Mo$
Input Offset Current			0.5	3.8		0.8	6.0		0.8	6.0	nA
Input Bias Current			± 1.2	± 4.0		± 1.8	± 7.0		± 2.0	± 12	nA
Input Noise Voltage	0.1Hz to 10Hz		0.35	0.6		0.38	0.65		0.38	0.65	$\mu V_{P-P}$
Input Noise Voltage Density	$f_o = 10Hz$ $f_o = 100Hz$ (Note 4) $f_o = 1000Hz$		10.3 10.0 9.6	18.0 13.0 11.0		10.5 10.2 9.8	20.0 13.5 11.5		10.5 10.3 9.8	20.0 13.5 11.5	nV/ $\sqrt{Hz}$
Input Noise Current	0.1Hz to 10Hz		14	30		15	35		15	35	pA $_{P-P}$
Input Noise Current Density	$f_o = 10Hz$ $f_o = 100Hz$ (Note 4) $f_o = 1000Hz$		0.32 0.14 0.12	0.80 0.23 0.17		0.35 0.15 0.13	0.90 0.27 0.18		0.35 0.15 0.13	0.90 0.27 0.18	pA/ $\sqrt{Hz}$
Input Resistance Differential-Mode	(Note 5)	15	50		8	33		7	31		M $\Omega$
Input Resistance Common-Mode			160			120			120		G $\Omega$
Input Voltage Range		± 13	± 14		± 13	± 14		± 13	± 14		V
Common-Mode Rejection Ratio	$V_{CM} = \pm 13$	106	123		100	120		94	110		dB
Power Supply Rejection Ratio	$V_S = \pm 13$ to $\pm 18$		5	20		7	32		7	32	$\mu V/V$
Large-Signal Voltage Gain	$R_L \geq 2k\Omega$ , $V_O = \pm 10V$ $R_L \geq 500\Omega$ , $V_O = \pm 0.5V$ , $V_S = \pm 0.5V$ (Note 5)	200 150	500 400		120 100	400 400		120 400	400 400		V/mV
Output Voltage Swing	$R_L \geq 10k\Omega$ $R_L \geq 2k\Omega$ $R_L \geq 1k\Omega$	± 12.5 ± 12.0 ± 10.5	± 13.0 ± 12.8 ± 12.0		± 12.0 ± 11.5	± 13.0 ± 12.8 ± 12.0		± 12.0 ± 11.5	± 13.0 ± 12.8 ± 12.0		V
Slew Rate	$R_L \geq 2k\Omega$ (Note 4)	0.1	0.3		0.1	0.3		0.1	0.3		V/ $\mu s$
Closed-Loop Bandwidth	$A_{VCL} = +1$ (Note 6)	0.4	0.6		0.4	0.6		0.4	0.6		MHz
Open-Loop Output Resistance	$V_O = 0$ , $I_O = 0$		60			60			60		$\Omega$
Power Consumption	$V_S = \pm 15V$ , No Load $V_S = \pm 3V$ , No Load		75 4	120 6		80 4	150 8		80 4	150 8	mW
Offset Adjustment Range	$R_P = 20k\Omega$		± 4			± 4			± 4		mV

## ELECTRICAL CHARACTERISTICS

Electrical Characteristics at  $V_{IN} = \pm 15$ , at  $-40^{\circ}\text{C} \leq T_A \leq +85^{\circ}\text{C}$  unless otherwise specified.

Parameter	Conditions	AMSOP-07E			AMSOP-07 C			AMSOP-07 D			Units
		Min	Typ	Max	Min	Typ	Max	Min	Typ	Max	
Input Offset Voltage	(Note 2)		45	130		85	250		85	250	$\mu\text{V}$
Average Input Offset Voltage Drift (Note 5)	Without External Trim		0.3	1.3		0.5	1.8		0.7	2.5	$\mu\text{V}/^{\circ}\text{C}$
	With External Trim $R_p = 2\text{k}\Omega$		0.3	1.3		0.4	1.6		0.7	2.5	$\mu\text{V}/^{\circ}\text{C}$
Input Offset Current			0.9	5.3		1.6	8.0		1.6	8.0	nA
Average Input Offset Current Drift	(Note 4)		8	35		12	50		12	50	$\text{pA}/^{\circ}\text{C}$
Input Bias Current			$\pm 1.5$	$\pm 5.5$		$\pm 2.2$	$\pm 9.0$		$\pm 3.0$	$\pm 14$	nA
Average Input Bias Current Drift	(Note 4)		13	35		18	50		18	50	$\text{pA}/^{\circ}\text{C}$
Input Voltage Range		$\pm 13$	$\pm 13.5$		$\pm 13$	$\pm 13.5$		$\pm 13$	$\pm 13.5$		V
Common-Mode Rejection Ratio	$V_{CM} = \pm 13$	103	123		97	120		94	106		dB
Power Supply Rejection Ratio	$V_S = \pm 13$ to $\pm 18$		7	32		10	51		10	51	$\mu\text{V}/\text{V}$
Large-Signal Voltage Gain	$R_L \geq 2\text{k}\Omega$ , $V_O = \pm 10\text{V}$	180	450		100	400		100	400		V/mV
Output Voltage Swing	$R_L \geq 2\text{k}\Omega$	$\pm 12.0$	$\pm 13.0$		$\pm 12.0$	$\pm 13.0$		$\pm 12.0$	$\pm 13.0$		V

**Note 1:** Absolute Maximum Ratings indicate limits beyond which damage to the device may occur. Operating Ratings indicate conditions for which the device is intended to be functional, but do not guarantee specific performance limits. For guaranteed specifications and test conditions, see the Electrical Characteristics. The guaranteed specifications apply only for the test conditions listed.

**Note 2:** Input Offset Voltage measurements are performed by automated test equipment approximately 0.5 seconds after application of power.

**Note 3:** Long-Term Input Offset Voltage Stability refers to the averaged trend line of VOS vs. Time over extended periods after the first 30 days of operation. Excluding the initial hour of operation, changes in VOS during the first 30 operating days are typically  $2.5\mu\text{V}$ . Parameter is sample tested.

**Note 4:** Sample tested

**Note 5:** Guaranteed by design.

**Note 6:** Guaranteed but not tested.

## TYPICAL PERFORMANCE CHARACTERISTICS

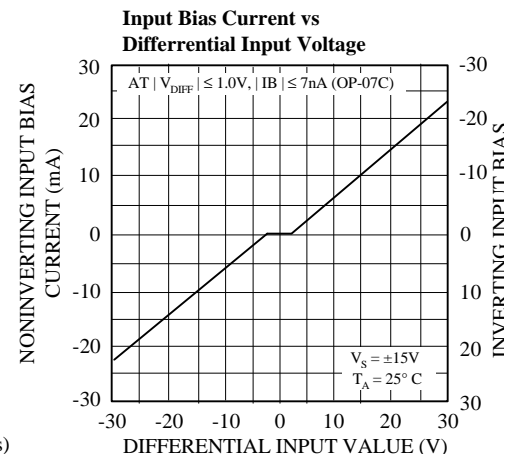
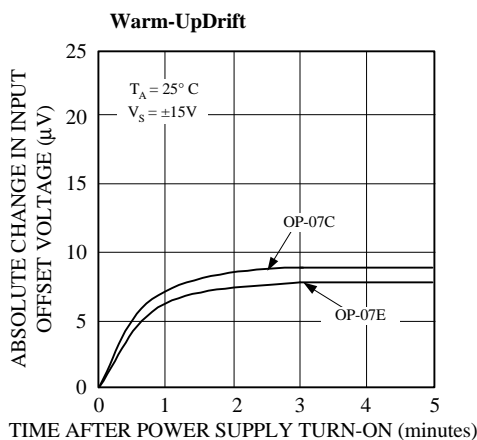
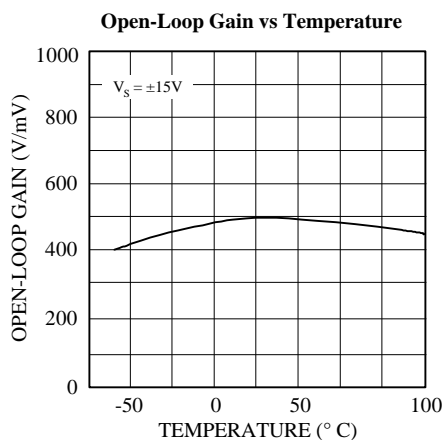

## TYPICAL PERFORMANCE CHARACTERISTICS (Continued)

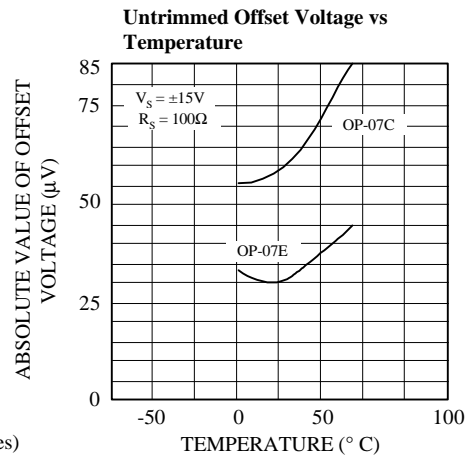
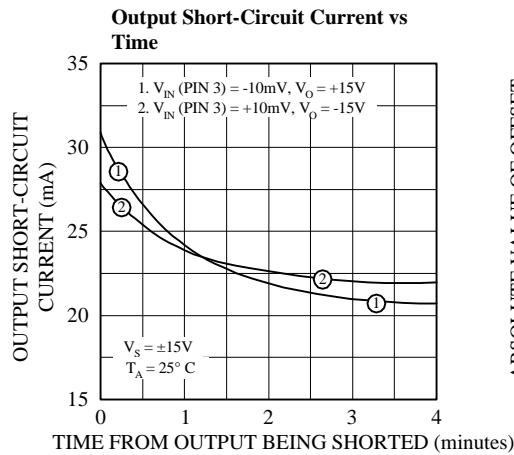
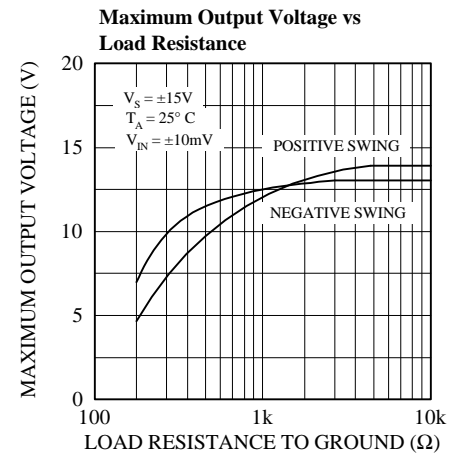
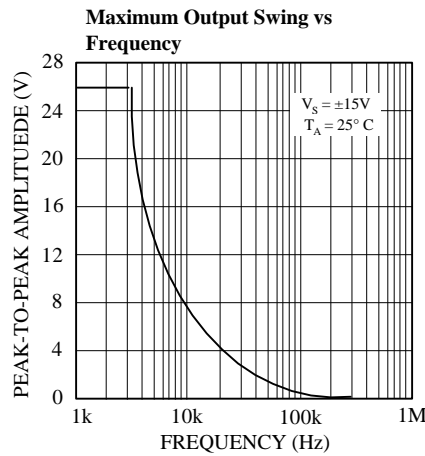
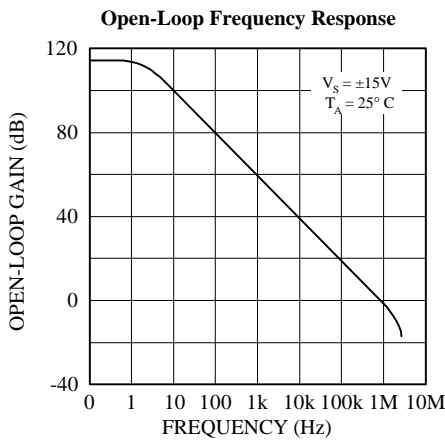
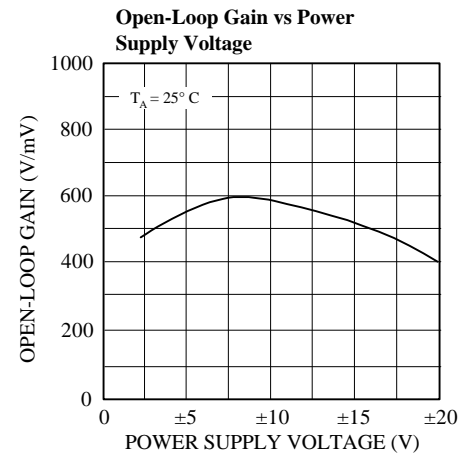
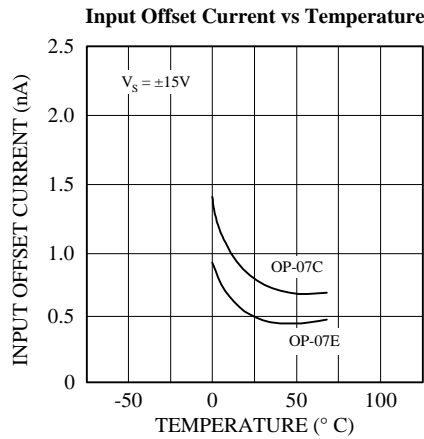
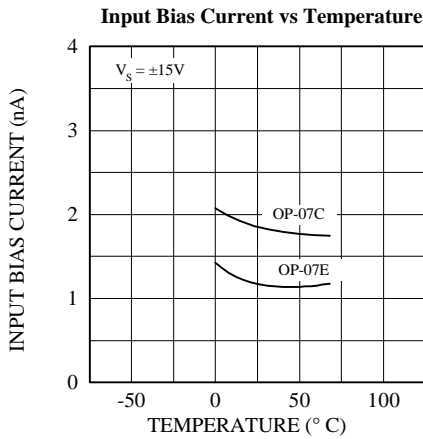

## TEST CIRCUITS

### TYPICAL OFFSET VOLTAGE TEST CIRCUIT

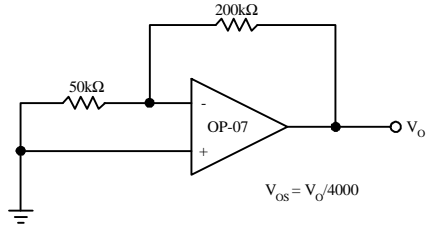

### TYPICAL LOW-FREQUENCY NOISE TEST CIRCUIT

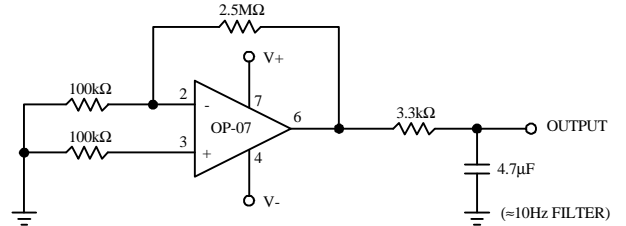

INPUT REFERRED NOISE =  $V_o / 25,000 = (5\text{mV/cm}) / 25,000 = 200\text{nV/cm}$

### OPTIONAL OFFSET NULLING CIRCUIT

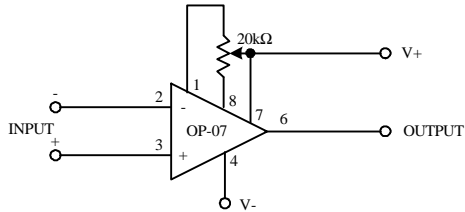

## TYPICAL APPLICATIONS

### Adjustment Free Precision Summing Amplifier

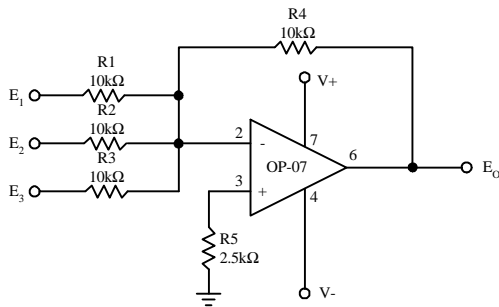

### Precision Absolute Value Circuit

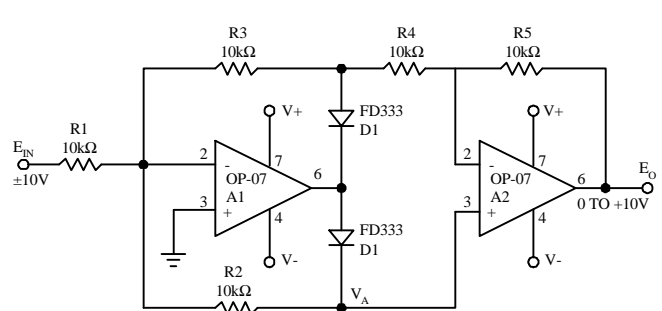

PACKAGE DIMENSIONS inches (millimeters) unless otherwise noted.

## 8 LEAD SOIC PLASTIC PACKAGE (S)

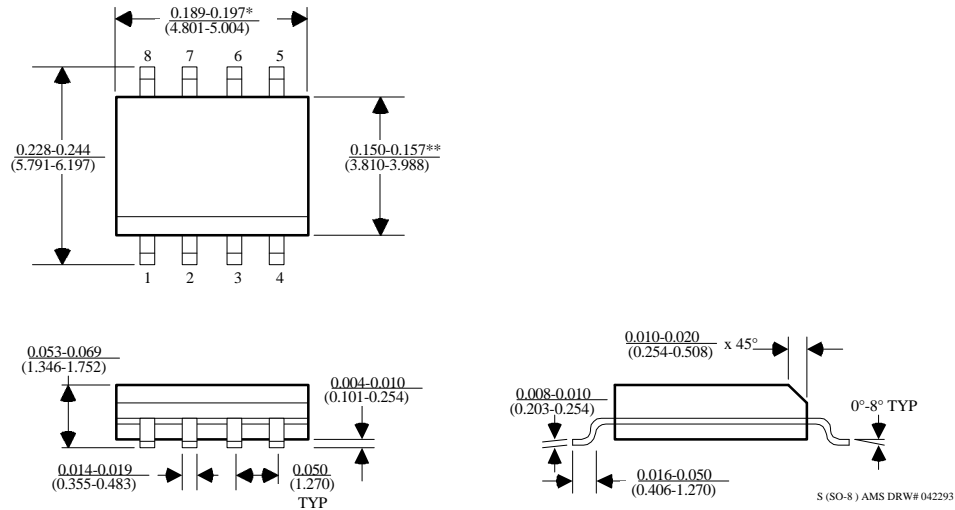

\*DIMENSION DOES NOT INCLUDE MOLD FLASH. MOLD FLASH SHALL NOT EXCEED 0.006" (0.152mm) PER SIDE

\*\*DIMENSION DOES NOT INCLUDE INTERLEAD FLASH. INTERLEAD FLASH SHALL NOT EXCEED 0.010" (0.254mm) PER SIDE

## 8 LEAD PLASTIC DIP PACKAGE (P)

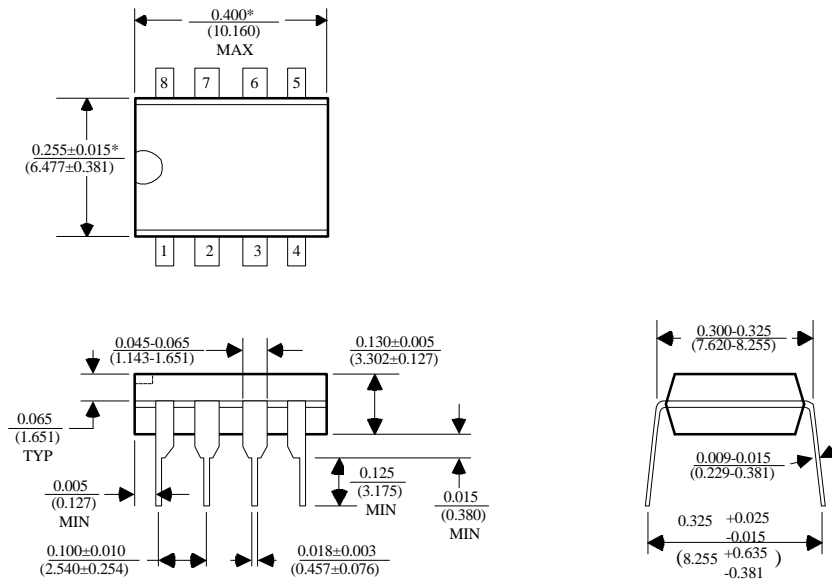

\*DIMENSIONS DO NOT INCLUDE MOLD FLASH OR PROTUSIONS. MOLD FLASH OR PROTUSIONS SHALL NOT EXCEED 0.010" (0.254mm)