

MM74HCT00 Quad 2 Input NAND Gate

General Description

The MM74HCT00 is a NAND gates fabricated using advanced silicon-gate CMOS technology which provides the inherent benefits of CMOS—low quiescent power and wide power supply range. This device is input and output characteristic and pin-out compatible with standard 74LS logic families. All inputs are protected from static discharge damage by internal diodes to V_{CC} and ground.

MM74HCT devices are intended to interface between TTL and NMOS components and standard CMOS devices. These parts are also plug-in replacements for LS-TTL devices and can be used to reduce power consumption in existing designs.

Features

- TTL, LS pin-out and threshold compatible
- Fast switching: t_{PLH} , t_{PHL} =14 ns (typ)
- Low power: 10 μ W at DC
- High fan out, 10 LS-TTL loads

Ordering Code:

Order Number	Package Number	Package Description
MM74HCT00M	M14A	14-Lead Small Outline Integrated Circuit (SOIC), JEDEC MS-012, 0.150" Narrow
MM74HCT00MX_NL	M14A	Pb-Free 14-Lead Small Outline Integrated Circuit (SOIC), JEDEC MS-012, 0.150" Narrow
MM74HCT00SJ	M14D	Pb-Free 14-Lead Small Outline Package (SOP), EIAJ TYPE II, 5.3mm Wide
MM74HCT00MTC	MTC14	14-Lead Thin Shrink Small Outline Package (TSSOP), JEDEC MO-153, 4.4mm Wide
MM74HCT00MTCX_NL	MTC14	Pb-Free 14-Lead Thin Shrink Small Outline Package (TSSOP), JEDEC MO-153, 4.4mm Wide
MM74HCT00N	N14A	14-Lead Plastic Dual-In-Line Package (PDIP), JEDEC MS-001, 0.300" Wide
MM74HCT00N_NL	N14A	Pb-Free 14-Lead Plastic Dual-In-Line Package (PDIP), JEDEC MS-001, 0.300" Wide

Devices also available in Tape and Reel. Specify by appending the suffix letter "X" to the ordering code.
Pb-Free package per JEDEC J-STD-020B.

Connection Diagram

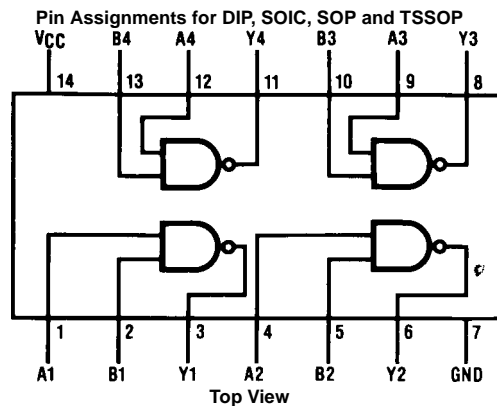

Logic Diagram

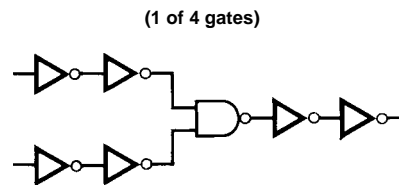

Absolute Maximum Ratings (Note 1)

(Note 2)

Supply Voltage (V_{CC})	-0.5 to +7.0V
DC Input Voltage (V_{IN})	-1.5 to $V_{CC}+1.5V$
DC Output Voltage (V_{OUT})	-0.5 to $V_{CC}+0.5V$
Clamp Diode Current (I_{IK}, I_{OK})	± 20 mA
DC Output Current, per pin (I_{OUT})	± 25 mA
DC V_{CC} or GND Current, per pin (I_{CC})	± 50 mA
Storage Temperature Range (T_{STG})	-65°C to +150°C
Power Dissipation (P_D)	
(Note 3)	600 mW
S.O. Package only	500 mW
Lead Temperature (T_L)	
(Soldering 10 seconds)	260°C

Recommended Operating Conditions

	Min	Max	Units
Supply Voltage (V_{CC})	4.5	5.5	V
DC Input or Output Voltage (V_{IN}, V_{OUT})	0	V_{CC}	V
Operating Temperature Range (T_A)	-40	+85	°C
Input Rise or Fall Times (t_r, t_f)		500	ns

Note 1: Absolute Maximum Ratings are those values beyond which damage to the device may occur.

Note 2: Unless otherwise specified all voltages are referenced to ground.

Note 3: Power Dissipation temperature derating — plastic "N" package: -12 mW/°C from 65°C to 85°C.

DC Electrical Characteristics $V_{CC} = 5V \pm 10\%$ (unless otherwise specified)

Symbol	Parameter	Conditions	$T_A = 25^\circ\text{C}$		$T_A = -40$ to 85°C	$T_A = -55$ to 125°C	Units
			Typ	Guaranteed Limits			
V_{IH}	Minimum HIGH Level Input Voltage			2.0	2.0	2.0	V
V_{IL}	Maximum LOW Level Input Voltage			0.8	0.8	0.8	V
V_{OH}	Minimum HIGH Level Output Voltage	$V_{IN} = V_{IH}$ or V_{IL}	V_{CC}	$V_{CC}-0.1$	$V_{CC}-0.1$	$V_{CC}-0.1$	V
		$ I_{OUT} = 20 \mu\text{A}$	4.2	3.98	3.84	3.7	V
		$ I_{OUT} = 4.0 \text{ mA}, V_{CC} = 4.5V$ $ I_{OUT} = 4.8 \text{ mA}, V_{CC} = 5.5V$	5.2	4.98	4.84	4.7	V
V_{OL}	Maximum LOW Level Voltage	$V_{IN} = V_{IH}$	0	0.1	0.1	0.1	V
		$ I_{OUT} = 20 \mu\text{A}$	0.2	0.26	0.33	0.4	V
		$ I_{OUT} = 4.0 \text{ mA}, V_{CC} = 4.5V$ $ I_{OUT} = 4.8 \text{ mA}, V_{CC} = 5.5V$	0.2	0.26	0.33	0.4	V
I_{IN}	Maximum Input Current	$V_{IN} = V_{CC}$ or GND, V_{IH} or V_{IL}		± 0.05	± 0.5	± 1.0	μA
I_{CC}	Maximum Quiescent Supply Current	$V_{IN} = V_{CC}$ or GND, $I_{OUT} = 0 \mu\text{A}$		1.0	10	40	μA
		$V_{IN} = 2.4V$ or $0.5V$ (Note 4)	0.18	0.3	0.4	0.5	mA

Note 4: This is measured per input with all other inputs held at V_{CC} or ground.

AC Electrical Characteristics
 $V_{CC} = 5.0V$, $t_r = t_f = 6 \text{ ns}$, $C_L = 15 \text{ pF}$, $T_A = 25^\circ\text{C}$ (unless otherwise noted)

Symbol	Parameter	Conditions	Typ	Guaranteed Limit	Units
t_{PLH} , t_{PHL}	Maximum Propagation Delay		14	18	ns

AC Electrical Characteristics
 $V_{CC} = 5.0V \pm 10\%$, $t_r = t_f = 6 \text{ ns}$, $C_L = 50 \text{ pF}$ (unless otherwise noted)

Symbol	Parameter	Conditions	$T_A = 25^\circ\text{C}$		$T_A = -40 \text{ to } 85^\circ\text{C}$	$T_A = -55 \text{ to } 125^\circ\text{C}$	Units
			Typ	Guaranteed Limits			
t_{PLH} , t_{PHL}	Maximum Propagation Delay		18	23	29	35	ns
t_{THL} , t_{TLH}	Maximum Output Rise & Fall Time		8	15	19	22	ns
C_{PD}	Power Dissipation Capacitance	(Note 5)	30				pF
C_{IN}	Input Capacitance		5	10	10	10	pF

Note 5: C_{PD} determines the no load dynamic power consumption, $P_D = C_{PD} V_{CC}^2 f + I_{CC} V_{CC}$, and the no load dynamic current consumption, $I_S = C_{PD} V_{CC} f + I_{CC}$.

Physical Dimensions inches (millimeters) unless otherwise noted

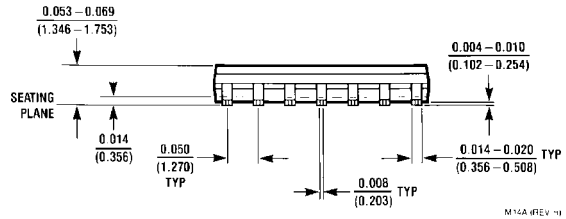
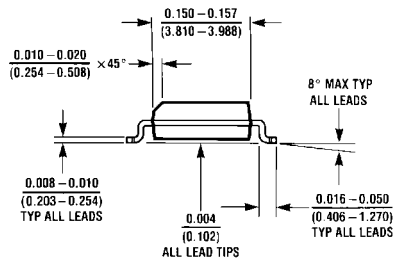
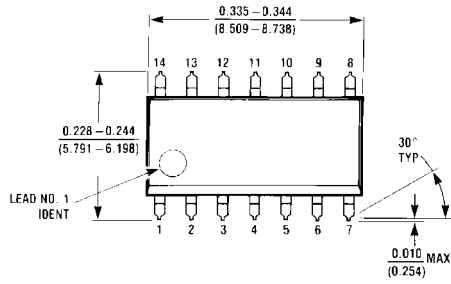

**14-Lead Small Outline Integrated Circuit (SOIC), JEDEC MS-012, 0.150" Narrow
Package Number M14A**

Physical Dimensions inches (millimeters) unless otherwise noted (Continued)

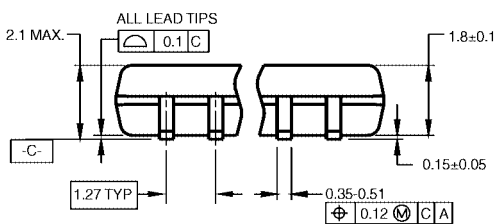
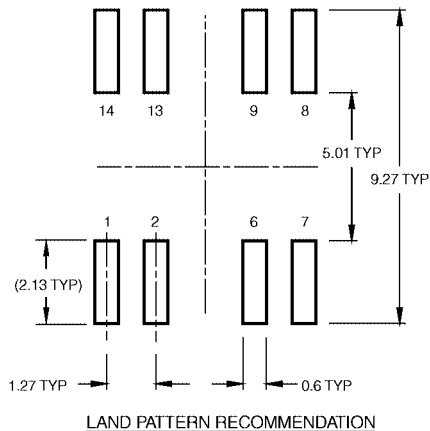
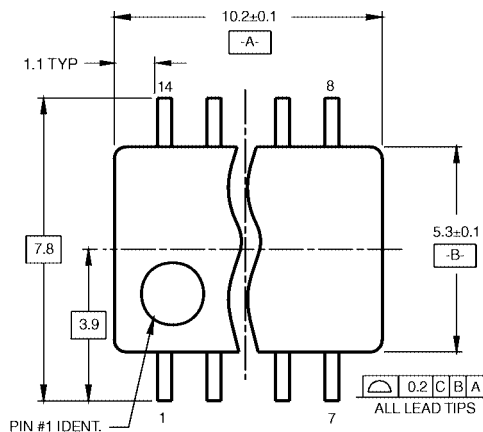

DIMENSIONS ARE IN MILLIMETERS

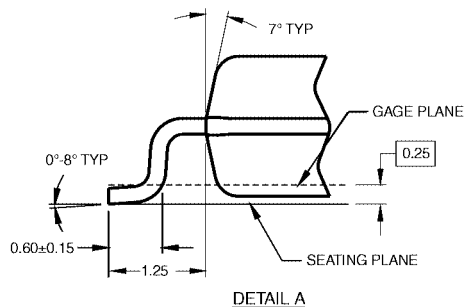
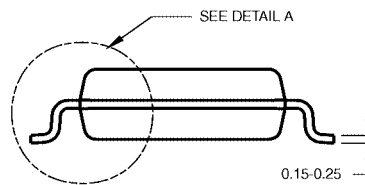

- NOTES:
- A. CONFORMS TO EIAJ EDR-7320 REGISTRATION, ESTABLISHED IN DECEMBER, 1998.
 - B. DIMENSIONS ARE IN MILLIMETERS.
 - C. DIMENSIONS ARE EXCLUSIVE OF BURRS, MOLD FLASH, AND TIE BAR EXTRUSIONS.

M14DRevB1

Pb-Free 14-Lead Small Outline Package (SOP), EIAJ TYPE II, 5.3mm Wide Package Number M14D

Physical Dimensions inches (millimeters) unless otherwise noted (Continued)

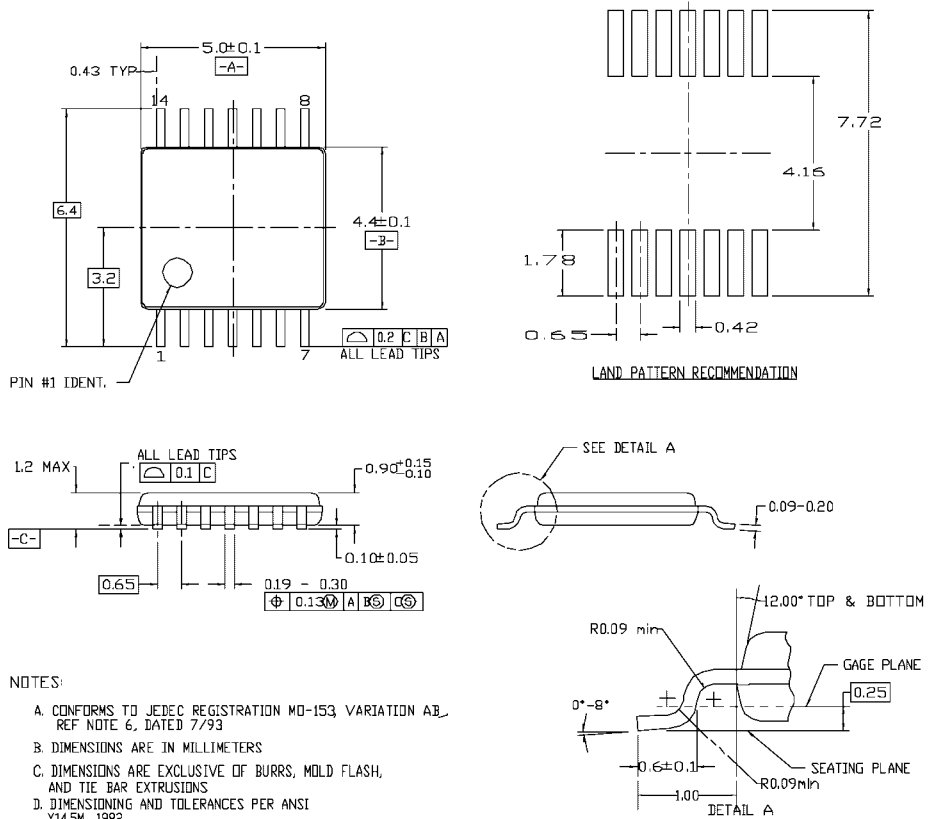

- NOTES:
- A. CONFORMS TO JEDEC REGISTRATION MO-153 VARIATION AB, REF NOTE 6, DATED 7/93
 - B. DIMENSIONS ARE IN MILLIMETERS
 - C. DIMENSIONS ARE EXCLUSIVE OF BURRS, MOLD FLASH, AND TIE BAR EXTRUSIONS
 - D. DIMENSIONING AND TOLERANCES PER ANSI Y14.5M, 1982

MTC14revD

14-Lead Thin Shrink Small Outline Package (TSSOP), JEDEC MO-153, 4.4mm Wide Package Number MTC14

Physical Dimensions inches (millimeters) unless otherwise noted (Continued)

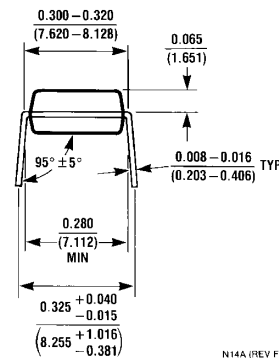
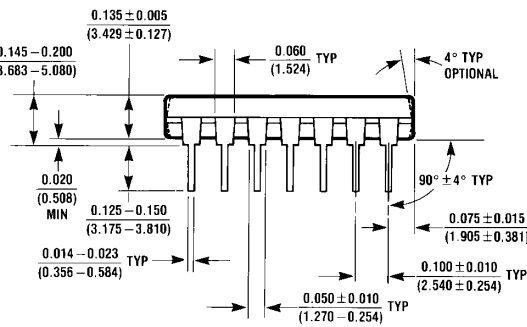
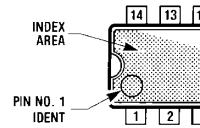
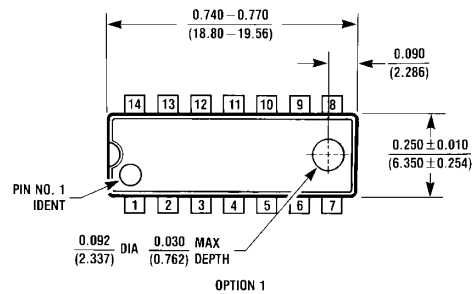

14-Lead Plastic Dual-In-Line Package (PDIP), JEDEC MS-001, 0.300" Wide Package Number N14A

N14A (REV F)

Fairchild does not assume any responsibility for use of any circuitry described, no circuit patent licenses are implied and Fairchild reserves the right at any time without notice to change said circuitry and specifications.

LIFE SUPPORT POLICY

FAIRCHILD'S PRODUCTS ARE NOT AUTHORIZED FOR USE AS CRITICAL COMPONENTS IN LIFE SUPPORT DEVICES OR SYSTEMS WITHOUT THE EXPRESS WRITTEN APPROVAL OF THE PRESIDENT OF FAIRCHILD SEMICONDUCTOR CORPORATION. As used herein:

1. Life support devices or systems are devices or systems which, (a) are intended for surgical implant into the body, or (b) support or sustain life, and (c) whose failure to perform when properly used in accordance with instructions for use provided in the labeling, can be reasonably expected to result in a significant injury to the user.
2. A critical component in any component of a life support device or system whose failure to perform can be reasonably expected to cause the failure of the life support device or system, or to affect its safety or effectiveness.

www.fairchildsemi.com