

ICL8021/ICL8022/ ICL8023

Low Power Bipolar Operational Amplifier



ICL8021/ICL8022/ICL8023

GENERAL DESCRIPTION

The Intersil ICL8021 series are low power operational amplifiers specifically designed for applications requiring very low standby power consumption over a wide range of supply voltages. The electrical characteristics of the 8021 series can be tailored to a particular application by adjusting an external resistor, R_{SET} , which controls the quiescent current. This is advantageous because I_Q can be made independent of the supply voltages: it can be set to an extremely low value where power is critical, or to a larger value for high slew rate or wideband applications.

Other features of the 8021 series include low input current that remains constant with temperature, low noise, high input impedance, internal compensation and pin-for-pin compatibility with the 741.

The Intersil 8022 (8023) consists of two (three) low power operational amplifiers in a single 14(16)-pin DIP. Each amplifier is identical to an 8021 low power op amp, and has separate connections for adjusting its electrical characteristics by means of an external resistor, R_{SET} , which controls the quiescent current of that amplifier.

ORDERING INFORMATION

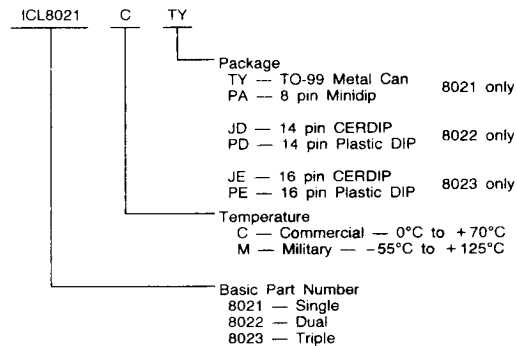

FEATURES

- $V_{OS} = 3mV$ Max (Adjustable to Zero)
- $\pm 1.5V$ to $\pm 18V$ Power Supply Operation
- Power Consumption — $20\mu W$ @ $\pm 1V$
- Input Bias Current — $30nA$ Max
- Internal Compensation
- Pin-For-Pin Compatible With 741
- Short Circuit Protected

PART NUMBER	TEMPERATURE RANGE	PACKAGE
ICL8021/D	—	DICE**
ICL8021CJA	0°C to 70°C	8 Lead CERDIP
ICL8021CBA	0°C to 70°C	8 Lead S.O.I.C
ICL8021CPA	0°C to 70°C	8 Lead MINIDIP
ICL8021CTY	0°C to 70°C	8 Lead Metal Can
ICL8021MJA	-55°C to +125°C	8 Lead CERDIP
ICL8021MJD	-55°C to +125°C	14 Lead CERDIP
ICL8021MTY	-55°C to +125°C	8 Lead Metal Can
ICL8022/D	—	DICE
ICL8022CJD	0°C to 70°C	14 Lead CERDIP
ICL8022CPD	0°C to 70°C	14 Lead MINIDIP
ICL8022MJD	-55°C to +125°C	14 Lead CERDIP
ICL8023/D	—	DICE
ICL8023CJE	0°C to 70°C	16 Lead CERDIP
ICL8023CPE	0°C to 70°C	16 Lead MINIDIP
ICL8023MJE	-55°C to +125°C	16 Lead CERDIP

**Parameter Min/Max Limits guaranteed at 25°C only for DICE orders.

4

ABSOLUTE MAXIMUM RATINGS

Supply Voltage	$\pm 18V$
Differential Input Voltage (Note 1)	$\pm 15V$
Common Mode Input Voltage (Note 1)	$\pm 15V$
Output Short Circuit Duration	Indefinite
Power Dissipation (Note 2)	300mW

Operating Temperature Range	
8021M	$-55^{\circ}C$ to $+125^{\circ}C$
8021C	$0^{\circ}C$ to $+70^{\circ}C$
Storage Temperature Range	$-65^{\circ}C$ to $+150^{\circ}C$
Lead Temperature (Soldering, 10sec)	$+300^{\circ}C$

NOTE 1: For supply voltages less than $\pm 15V$, the absolute maximum input voltage is equal to the supply voltage.

NOTE 2: Rating applies for case temperatures to $+125^{\circ}C$; derate linearly at $5.6 \text{ mW}/^{\circ}C$ for ambient temperatures above $+95^{\circ}C$.

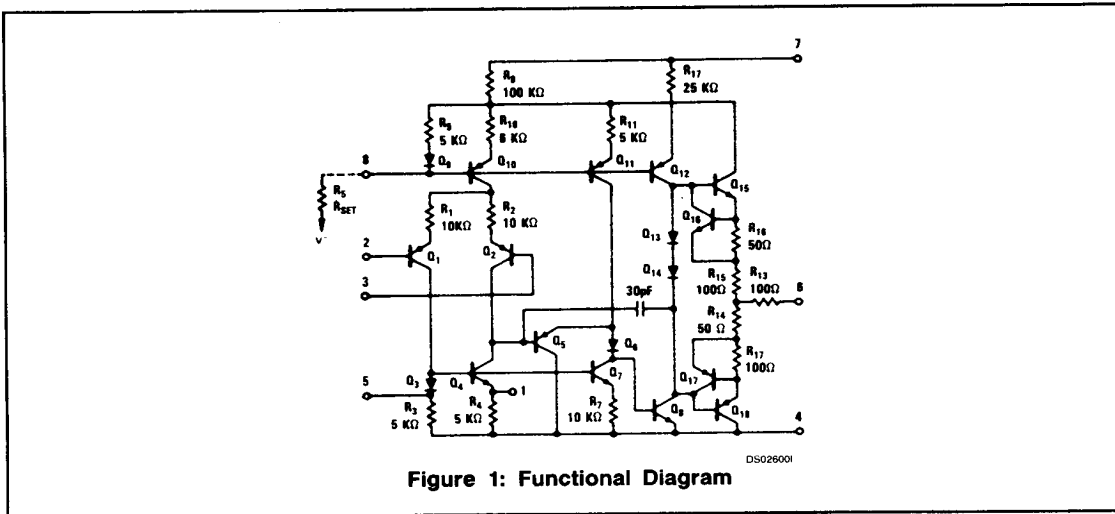

Figure 1: Functional Diagram

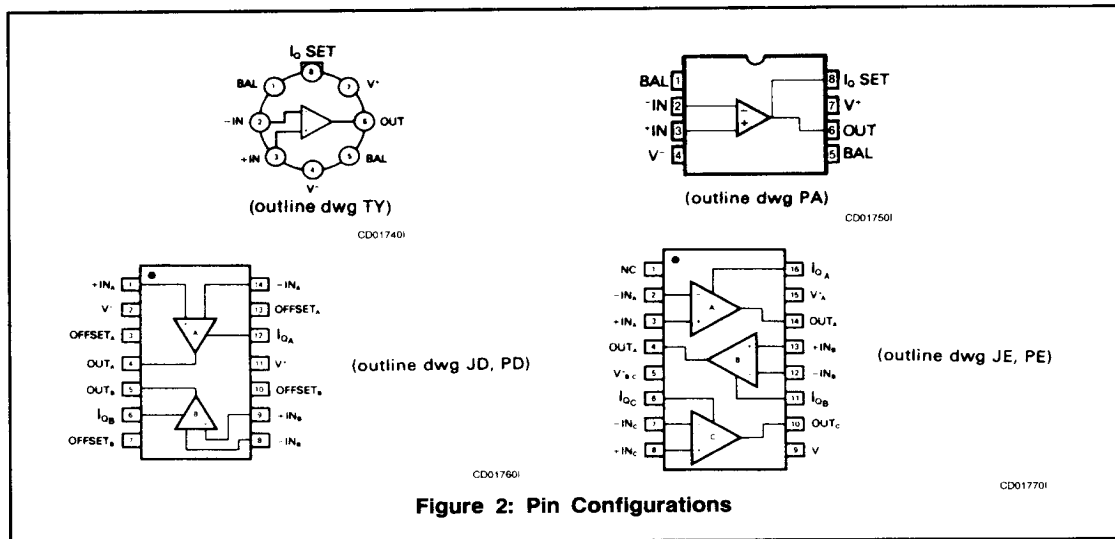

Figure 2: Pin Configurations

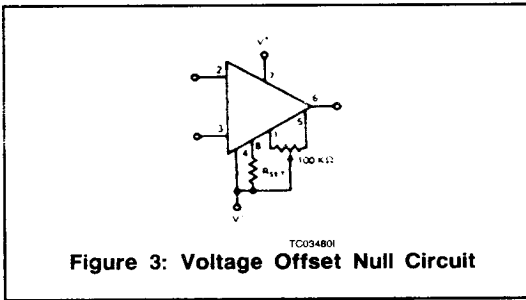

Figure 3: Voltage Offset Null Circuit

ELECTRICAL CHARACTERISTICS ($V_{SUPPLY} = \pm 6V$, $I_Q = 30\mu A$, unless otherwise specified.)

CHARACTERISTICS	TEST CONDITIONS	8021M			8021C			UNIT	
		MIN	TYP	MAX	MIN	TYP	MAX		
The following specifications apply for $T_A = 25^\circ C$:									
Input Offset Voltage	$R_S \leq 100k\Omega$		2	3		2	6	mV	
Input Offset Current			.5	7.5		.7	10	nA	
Input Bias Current			5	20		7	30	nA	
Input Resistance		3	10		3	10		MΩ	
Input Voltage Range	$V_{SUPPLY} = \pm 15V$	± 12	± 13		± 12	± 13		V	
Common Mode Rejection Ratio	$R_S \leq 10k\Omega$	70	80		70	80		dB	
Supply Voltage Rejection Ratio	$R_S \leq 10k\Omega$		30	150		30	150	$\mu V/V$	
Output Resistance	Open Loop		2			2		kΩ	
Output Voltage Swing	$R_L \geq 20k\Omega$, $V_{SUPPLY} = \pm 15V$	± 12	± 14		± 12	± 14		V	
	$R_L \geq 10k\Omega$, $V_{SUPPLY} = \pm 15V$	± 11	± 13		± 11	± 13		V	
Output Short-Circuit Current			± 13			± 13		mA	
Power Consumption	$V_{OUT} = 0$		360	480		360	600	μW	
Slew Rate (Unity Gain)			0.16			0.16		V/ μs	
Unity Gain Bandwidth	$R_L = 20k\Omega$, $V_{IN} = 20mV$		270			270		kHz	
Transient Response (Unity Gain)	$R_L = 20k\Omega$, $V_{IN} = 20mV$		1.3			1.3		μs	
		Risetime							
		Overshoot		10			10		%
The following specifications apply for $0^\circ C \leq T_A \leq +70^\circ C$ (8021C) and $-55^\circ C \leq T_A \leq +125^\circ C$ (8021M)									
Input Offset Voltage	$R_S \leq 10k\Omega$		2.0	4.0		2.0	7.5	mV	
Input Offset Current			1.0	11		1.5	15	nA	
Input Bias Current			10	32		15	50	nA	
Average Temperature Coefficient of Input Offset Voltage	$R_S \leq 10k\Omega$		5			5		$\mu V/^\circ C$	
Average Temperature Coefficient of Input Offset Current			1.7			0.8		$pA/^\circ C$	
Large Signal Voltage Gain	$R_L = 10k\Omega$	50	200		50	200		V/mV	
Output Voltage Swing	$R_L \geq 10k\Omega$	± 10	± 13		± 10	± 13		V	

4

Note: All typical values have been guaranteed by characterization and are not tested.

QUIESCENT CURRENT ADJUSTMENT

QUIESCENT CURRENT SETTING RESISTOR
(PIN 8 to V⁻)

V _S	I _Q			
	10 μA	30 μA	100 μA	300 μA
±1.5	1.5MΩ	470kΩ	150kΩ	—
±3	3.3MΩ	1.1MΩ	330kΩ	100kΩ
±6	7.5MΩ	2.7MΩ	750kΩ	220kΩ
±9	13MΩ	4MΩ	1.3MΩ	350kΩ
±12	18MΩ	5.6MΩ	1.5MΩ	510kΩ
±15	22MΩ	7.5MΩ	2.2MΩ	620kΩ

QUIESCENT CURRENT SETTING RESISTOR
(PIN 8 to V⁻)

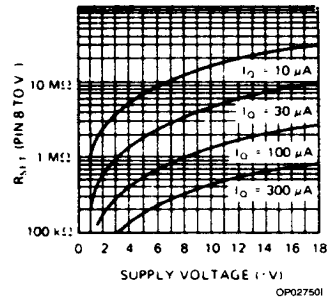

TYPICAL PERFORMANCE CHARACTERISTICS*

(T_A = +25°C, V_S = ±6V, I_Q = 30 μA unless otherwise specified.)

INPUT BIAS CURRENT VS QUIESCENT CURRENT

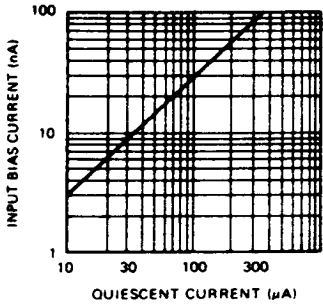

OP027601

INPUT BIAS CURRENT VS AMBIENT TEMPERATURE

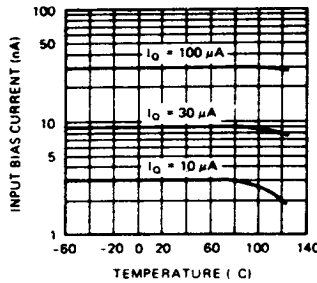

OP027701

DIFFERENTIAL INPUT IMPEDANCE VS QUIESCENT CURRENT

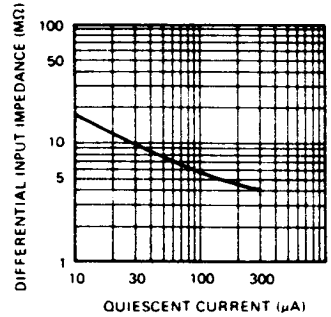

OP027801

SLEW RATE VS QUIESCENT CURRENT

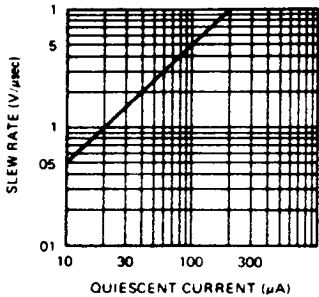

OP027901

FREQUENCY RESPONSE VS QUIESCENT CURRENT

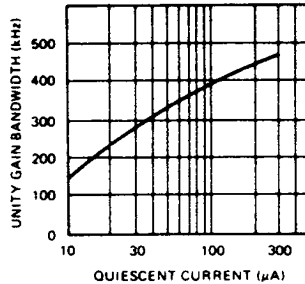

OP028001

PHASE MARGIN VS QUIESCENT CURRENT

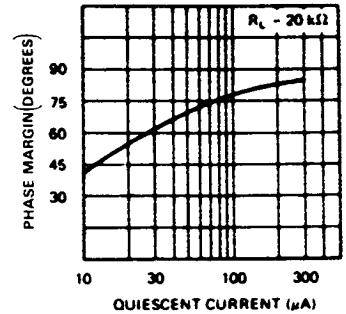

OP028121

Note: All typical values have been guaranteed by characterization and are not tested.

ICL8021/ICL8022/ICL8023



ICL8021/ICL8022/ICL8023

TYPICAL PERFORMANCE CHARACTERISTICS* (CONT.)

OPEN-LOOP FREQUENCY RESPONSE

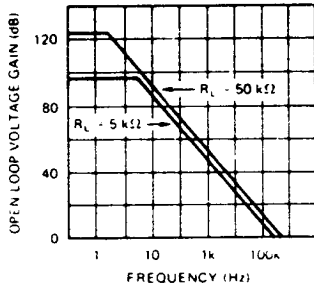

OP028201

TRANSIENT RESPONSE

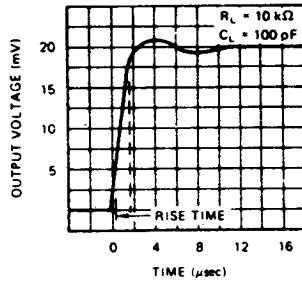

OP028301

MAXIMUM LOAD VS QUIESCENT CURRENT

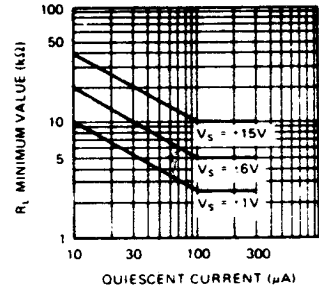

OP028401

OUTPUT VOLTAGE SWING VS SUPPLY VOLTAGE

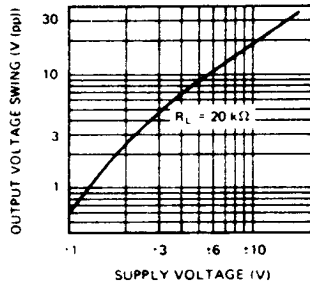

OP028501

EQUIVALENT INPUT NOISE VOLTAGE VS FREQUENCY

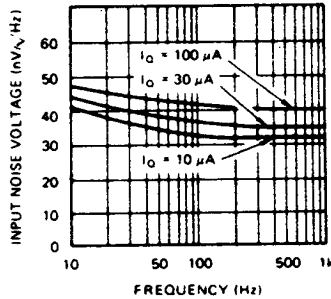

OP028601

EQUIVALENT INPUT NOISE CURRENT VS FREQUENCY

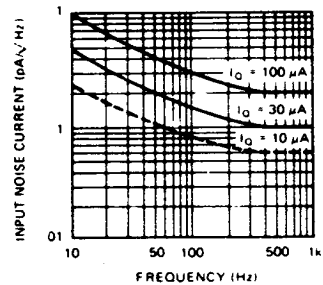

OP028701

*ICL8021C guaranteed only for $0^\circ\text{C} \leq T_A \leq +70^\circ\text{C}$

Note: All typical values have been guaranteed by characterization and are not tested.