

# LM108/A, LM308/A

## Super-Beta Operational Amplifier



### GENERAL DESCRIPTION

These differential input, precision amplifiers provide low input currents and offset voltages comparable to FET and chopper stabilized amplifiers. They feature low power consumption over a supply voltage range of  $> 2V$  to  $\pm 20V$ . The amplifiers may be frequency compensated with a single external capacitor. The LM108A and LM308A are high performance selections from the 108/308 amplifier family.

### FEATURES

- Input Bias Current — 2nA Max to 7nA Max
- Input Offset Current — 0.2nA Max to 1nA Max
- Input Offset Voltage — 0.5mV Max to 7.5mV Max
- $\Delta V_{os}/\Delta T$  —  $5\mu V/^\circ C$  to  $30\mu V/^\circ C$
- $\Delta I_{os}/\Delta T$  — 2.5pA/ $^\circ C$  to 10pA/ $^\circ C$
- Pin for Pin Replacement for 101A/301A

### ORDERING INFORMATION

PART NUMBER	TO-99 CAN	8 PIN MINIDIP	14 PIN CERDIP	10 PIN FLATPAK	** DICE
LM108A LM308A	LM108AH* LM308AH	— LM308AN	LM108AJ LM308AJ	LM108AF LM308AF	
LM108 LM308	LM108H* LM308H	— LM308N	LM108J LM308J	LM108F LM308F	LM308/D

\*If 883C processing is desired add /883C to part number.  
 \*\*Parametric Min/Max Limits guaranteed at 25°C only for DICE orders.

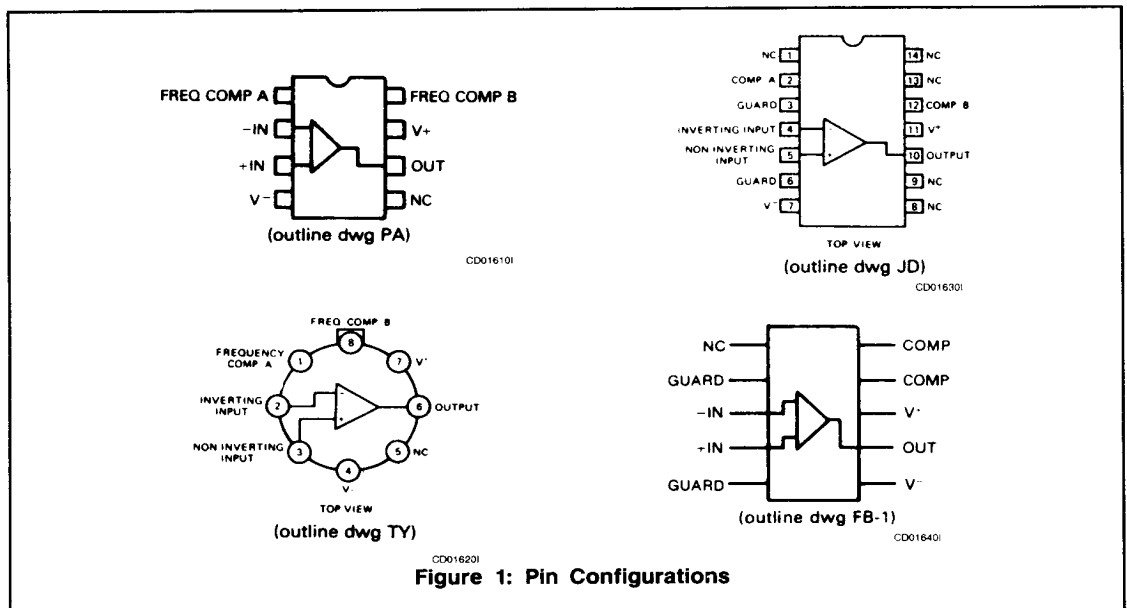

Note: All typical values have been guaranteed by characterization and are not tested.

# LM108/A, LM308/A



LM108/A, LM308/A

## ABSOLUTE MAXIMUM RATINGS

Supply Voltage	
108, 108A	±20V
308, 308A	±18V
Internal Power Dissipation (Note 1)	
Metal Can (TO-99)	500mW
DIP	500mW
Differential Input Current (Note 2)	±10mA

Input Voltage (Note 3)	±15V
Output Short-Circuit Duration	Indefinite
Operating Temperature Range	
108, 108A	-55°C to +125°C
308, 308A	0°C to +70°C
Storage Temperature Range	-65°C to +150°C
Lead Temperature (Soldering, 10sec)	300°C

## ELECTRICAL CHARACTERISTICS (T<sub>A</sub> = 25°C unless otherwise specified) (Note 4)

PARAMETER	TEST CONDITIONS	308			308A			108			108A			UNIT
		MIN	TYP	MAX	MIN	TYP	MAX	MIN	TYP	MAX	MIN	TYP	MAX	
Input Offset Voltage			2.0	7.5		0.3	0.5		0.7	2.0		0.3	0.5	mV
Input Offset Current			0.2	1.0		0.2	1.0		0.05	0.2		0.05	0.2	nA
Input Bias Current			1.5	7		1.5	7		0.8	2.0		0.8	2.0	nA
Input Resistance	Note 5	10	40		10	40		30	70		30	70		MΩ
Supply Current	V <sub>S</sub> = ±20V V <sub>S</sub> = ±15V		0.3	0.8		0.3	0.8		0.3	0.6		0.3	0.6	mA mA
Large Signal Voltage Gain	V <sub>S</sub> = ±15V, V <sub>OUT</sub> = ±10V R <sub>L</sub> > 10kΩ	25	300		80	300		50	300		80	300		V/mV
<b>THE FOLLOWING SPECIFICATIONS APPLY OVER THE OPERATING TEMPERATURE RANGES</b>														
Input Offset Voltage				10			0.73			3.0			1.0	mV
Input Offset Current				1.5			1.5			0.4			0.4	nA
Average Temperature Coefficient of Input Offset Voltage	Note 6		6.0	30		1.0	5.0		3.0	15		1.0	5.0	μV/°C
Average Temperature Coefficient of Input Offset Current	Note 6		2	10		2.0	10		0.5	2.5		0.5	2.5	pA/°C
Input Bias Current				10			10			3.0			3.0	nA
Large Signal Voltage Gain	V <sub>S</sub> = ±15V, V <sub>OUT</sub> = ±10V R <sub>L</sub> ≥ 10kΩ	15			60			25			40			V/mV
Input Voltage Range	V <sub>S</sub> = ±15V	±13.5			±13.5			±13.5			±13.5			V
Common Mode Rejection Ratio	V <sub>S</sub> = ±15V V <sub>CM</sub> = ±13.5V	80	100		96	110		85	100		96	110		dB
Supply Voltage Rejection Ratio	±5V to ±20V	80	96		96	110		80	96		96	110		dB
Output Voltage Swing	V <sub>S</sub> = ±15V, R <sub>L</sub> = 10kΩ	±13	±14		±13	±14		±13	±14		±13	±14		V
Supply Current	T <sub>A</sub> = +125°C, V <sub>S</sub> = ±20V								0.15	0.4		0.15	0.4	mA

- NOTES:**
- Derate Metal Can package at 6.8 mW/°C for operation at ambient temperatures above 75°C and the Dual In-Line package at 9mW/°C for operation at ambient temperatures above 95°C.
  - The inputs are shunted with back-to-back diodes for over-voltage protection. Therefore, excessive current will flow if a differential input voltage in excess of 1V is applied between the inputs unless some limiting resistance is used.
  - For supply voltages less than ±15V, the maximum input voltage is equal to the supply voltage.
  - Unless otherwise specified, these specifications apply for supply voltages from +5V to ±20V for the 108, and 108A and +5V to ±15V for the 308 and 308A.
  - Input resistance is guaranteed by Input Bias Current test.
  - For Design only, not 100% tested.

Note: All typical values have been guaranteed by characterization and are not tested.

TYPICAL PERFORMANCE CHARACTERISTICS

INPUT CURRENTS

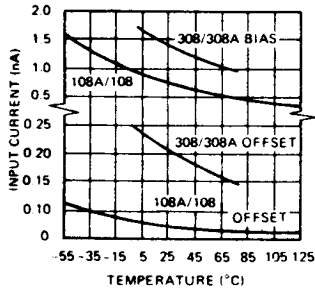

OP022001

MAXIMUM DRIFT ERROR

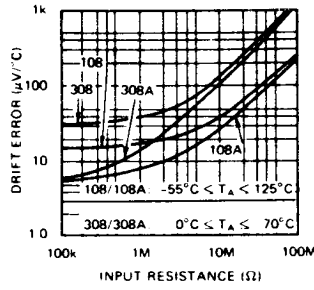

OP022201

MAXIMUM OFFSET ERROR

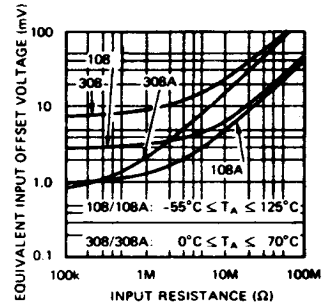

OP022101

POWER SUPPLY REJECTION

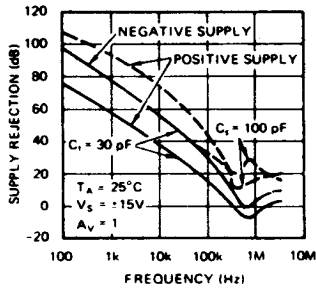

OP022301

INPUT NOISE VOLTAGE

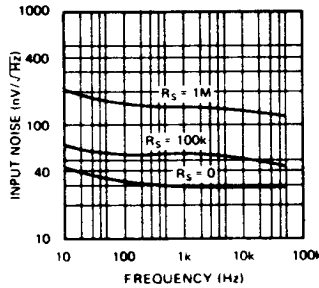

OP022411

OPEN LOOP VOLTAGE GAIN

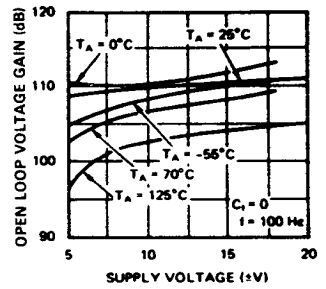

OP022511

OUTPUT SWING

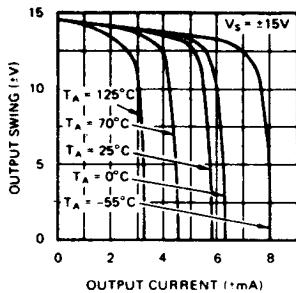

OP022601

SUPPLY CURRENT

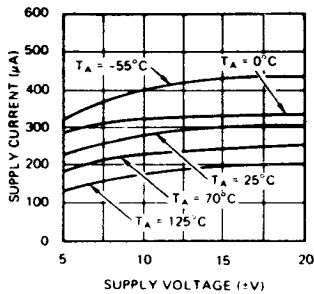

OP022701

OPEN LOOP FREQUENCY RESPONSE

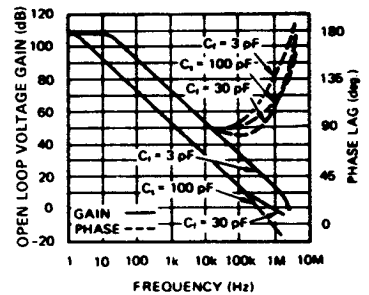

OP022811

Note: All typical values have been guaranteed by characterization and are not tested.

## TYPICAL PERFORMANCE CHARACTERISTICS (CONT.)

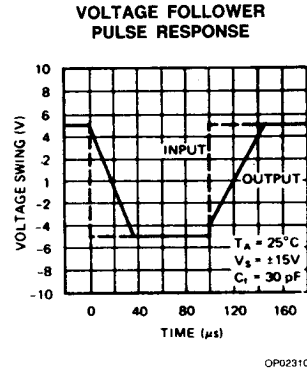
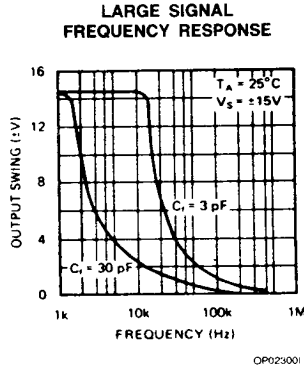
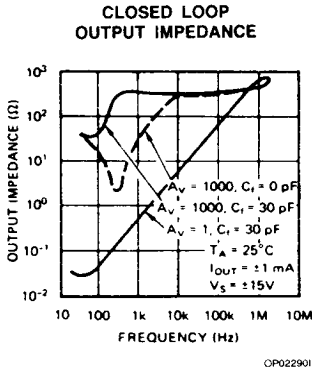

## GUARDING

Extra care must be taken in the assembly of printed circuit boards to take full advantage of the low input currents of the 108 amplifier. Boards must be thoroughly cleaned with TCE or alcohol and blown dry with compressed air. After cleaning, the boards should be coated with epoxy or silicone rubber to prevent contamination.

Even with properly cleaned and coated boards, leakage currents may cause trouble at 125°C, particularly since the input pins are adjacent to pins that are at supply potentials. This leakage can be significantly reduced by using guarding to lower the voltage difference between the inputs and adjacent metal runs. Input guarding of the 8-lead TO-99 package is accomplished by using a 10-lead pin circle, with the leads of the device formed so that the holes adjacent to the inputs are empty when it is inserted in the board. The guard, which is a conductive ring surrounding the inputs, is connected to a low impedance point that is at approximately the same voltage at the inputs. Leakage currents from high-voltage pins are then absorbed by the guard.

The pin configuration of the dual in-line package is designed to facilitate guarding, since the pins adjacent to the inputs are not used (this is different from the standard 741 and 101A pin configuration).

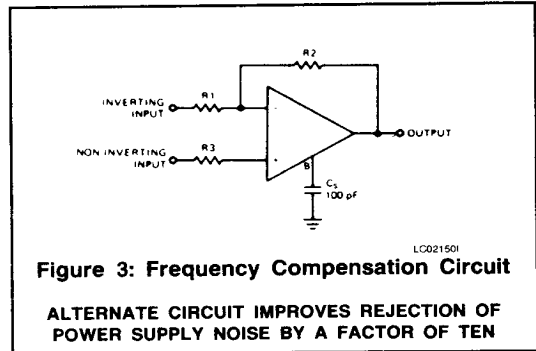

4

