

FEATURES

- *Guaranteed 25 μ V max. Offset Voltage*
- *Guaranteed 0.6 μ V/ $^{\circ}$ C max. Offset Voltage Drift with Temperature*
- *Excellent 1.0 μ V/Month max. Long Term Stability*
- *Guaranteed 0.6 μ V_{p-p} max. Noise*
- *Guaranteed 2.0nA max. Input Bias Current*

APPLICATIONS

- Thermocouple Amplifiers
- Strain Gauge Amplifiers
- Low Level Signal Processing
- Medical Instrumentation

DESCRIPTION

The OP-07 offers excellent performance in applications requiring low offset voltage, low drift with time and temperature and very low noise. Linear's OP-07 is interchangeable with many of the precision op-amp device types. The OP-07 also offers a wide input voltage range, high common mode rejection and low input bias current. These features result in optimum performance for small signal level and low frequency applications. Use of advanced design, processing and testing techniques make Linear's OP-07 a superior choice over similar products. A buffered reference application is shown below. For single op amp applications requiring higher performance, see the LT1001 and for matched dual precision applications see the LT1002.

Precision Buffered Single Supply Reference

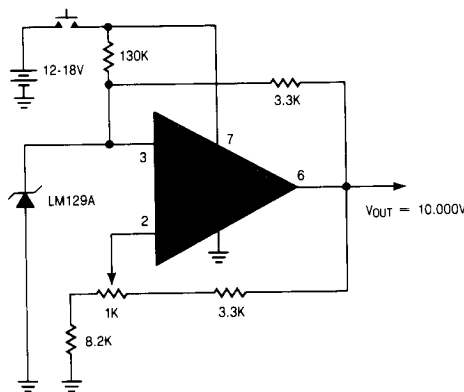

The OP-07 contributes less than 5% of the total drift with temperature, noise and long term drift of the reference application.

**Offset Voltage Drift With Temperature
Of Representative Units**

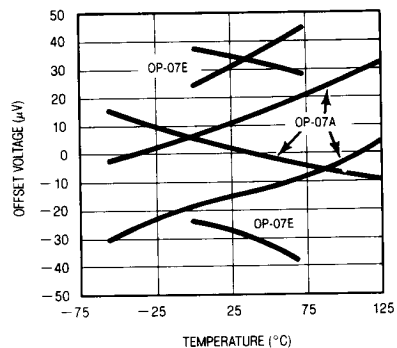

ABSOLUTE MAXIMUM RATINGS

| | |
|---------------------------------------|----------------|
| Supply Voltage | ±22V |
| Differential Input Voltage | ±30V |
| Input Voltage Equal to Supply Voltage | |
| Output Short Circuit Duration | Indefinite |
| Operating Temperature Range | |
| OP-07/OP-07A | −55°C to 125°C |
| OP-07E/OP-07C | 0°C to 70°C |
| Storage Temperature Range | |
| All Devices | −65°C to 150°C |
| Lead Temperature (Soldering, 10 sec.) | 300°C |

PACKAGE/ORDER INFORMATION

| | | |
|---|---|--|
| <p>TOP VIEW OFFSET ADJUST</p> <p>METAL CAN H PACKAGE</p> | ORDER PART NO. | OFFSET VOLTAGE (MAX) |
| | OP-07AH OP-07H OP-07EH OP-07CH | 25µV 75µV 75µV 150µV |
| <p>TOP VIEW</p> <p>HERMETIC DIP J8 PACKAGE PLASTIC DIP N8 PACKAGE</p> | OP-07AJ8 OP-07J8 OP-07EJ8 OP-07CJ8 OP-07EN8 OP-07CN8 | 25µV 75µV 75µV 150µV 75µV 150µV |

ELECTRICAL CHARACTERISTICS $V_S = \pm 15V$, $T_A = 25^\circ C$, unless otherwise noted.

| SYMBOL | PARAMETER | CONDITIONS | MIN | OP-07A TYP | MAX | MIN | OP-07 TYP | MAX | UNITS |
|-------------------------------------|--|---|-----|-------------------------|-------------------------|-----|-------------------------|-------------------------|-------------------|
| V_{OS} | Input Offset Voltage | (Note 1) | | 10 | 25 | | 30 | 75 | µV |
| $\frac{\Delta V_{OS}}{\Delta Time}$ | Long Term Input Offset Voltage Stability | (Notes 2 and 3) | | 0.2 | 1.0 | | 0.2 | 1.0 | µV/Month |
| I_{OS} | Input Offset Current | | | 0.3 | 2.0 | | 0.4 | 2.8 | nA |
| I_B | Input Bias Current | | | ±0.7 | ±2.0 | | ±1.0 | ±3.0 | nA |
| e_n | Input Noise Voltage | 0.1Hz to 10Hz (Note 2) | | 0.35 | 0.6 | | 0.35 | 0.6 | µV _{rms} |
| | Input Noise Voltage Density | $f_o = 10Hz$ $f_o = 100Hz$ (Note 2) $f_o = 1000Hz$ | | 10.3 10.0 9.6 | 18.0 13.0 11.0 | | 10.3 10.0 9.6 | 18.0 13.0 11.0 | nV/√Hz |
| i_n | Input Noise Current | 0.1Hz to 10Hz (Note 2) | | 14 | 30 | | 14 | 30 | pA _{rms} |
| | Input Noise Current Density | $f_o = 10Hz$ $f_o = 100Hz$ (Note 2) $f_o = 1000Hz$ | | 0.32 0.14 0.12 | 0.80 0.23 0.17 | | 0.32 0.14 0.12 | 0.80 0.23 0.17 | pA/√Hz |
| R_{in} | Input Resistance Differential Mode | (Note 4) | | 30 | 80 | | 20 | 60 | MΩ |
| | Input Resistance Common Mode | | | | 200 | | | 200 | GΩ |
| | Input Voltage Range | | | ±13.5 | ±14.0 | | ±13.5 | ±14.0 | V |
| CMRR | Common Mode Rejection Ratio | $V_{CM} = \pm 13V$ | | 110 | 126 | | 110 | 126 | dB |
| PSRR | Power Supply Rejection Ratio | $V_S = \pm 3V$ to $\pm 18V$ | | 100 | 108 | | 100 | 108 | dB |
| A_{VOL} | Large Signal Voltage Gain | $R_L \geq 2k\Omega$, $V_O = \pm 10V$ $R_L \geq 500\Omega$, $V_O = \pm 0.5V$ $V_S = \pm 3V$ (Note 4) | | 300 150 | 500 400 | | 200 150 | 500 400 | V/mV |
| V_{OUT} | Maximum Output Voltage Swing | $R_L \geq 10k\Omega$ $R_L \geq 2k\Omega$ $R_L \geq 1k\Omega$ | | ±12.5 ±12.0 ±10.5 | ±13.0 ±12.8 ±12.0 | | ±12.5 ±12.0 ±10.5 | ±13.0 ±12.8 ±12.0 | V |
| SR | Slew Rate | $R_L \geq 2k\Omega$ (Note 4) | | 0.1 | 0.25 | | 0.1 | 0.25 | V/µS |
| GBW | Closed Loop Bandwidth | $A_{VCL} = +1$ (Note 4) | | 0.4 | 0.6 | | 0.4 | 0.6 | MHz |
| Z_o | Open Loop Output Impedance | $V_O = 0$, $I_O = 0$, $f = 10Hz$ | | | 60 | | | 60 | Ω |
| P_d | Power Dissipation | $V_S = \pm 15V$ $V_S = \pm 3V$ | | 75 4 | 120 6 | | 75 4 | 120 6 | mW |
| | Offset Adjustment Range | Null Pot = 20kΩ | | | ±4 | | | ±4 | mV |

See Notes on page 2-210.

ELECTRICAL CHARACTERISTICS $V_S = \pm 15V$, $-55^\circ C \leq T_A \leq 125^\circ C$, unless otherwise noted.

| SYMBOL | PARAMETER | CONDITIONS | OP-07A | | | OP-07 | | | UNITS |
|-------------------------------------|---|---------------------------------------|--------|------------|------------|------------|------------|------------------|-------|
| | | | MIN | TYP | MAX | MIN | TYP | MAX | |
| V_{OS} | Input Offset Voltage | (Note 1) | ● | 25 | 60 | 60 | 200 | μV | |
| $\frac{\Delta V_{OS}}{\Delta Temp}$ | Average Input Offset Voltage Drift Without External Trim With External Trim | Null Pot = 20k Ω (Note 2) | ● | 0.2 0.2 | 0.6 0.6 | 0.3 0.3 | 1.3 1.3 | $\mu V/^\circ C$ | |
| I_{OS} | Input Offset Current | | ● | 0.8 | 4.0 | 1.2 | 5.6 | nA | |
| $\frac{\Delta I_{OS}}{\Delta Temp}$ | Average Input Offset Current Drift | (Note 2) | ● | 5 | 25 | 8 | 50 | $pA/^\circ C$ | |
| I_B | Input Bias Current | | ● | ± 1.0 | ± 4.0 | ± 2.0 | ± 6.0 | nA | |
| $\frac{\Delta I_B}{\Delta Temp}$ | Average Input Bias Current Drift | (Note 2) | ● | 8 | 25 | 13 | 50 | $pA/^\circ C$ | |
| | Input Voltage Range | | ● | ± 13.0 | ± 13.5 | ± 13.0 | ± 13.5 | V | |
| CMRR | Common Mode Rejection Ratio | $V_{CM} = \pm 13V$ | ● | 106 | 123 | 106 | 123 | dB | |
| PSRR | Power Supply Rejection Ratio | $V_S = \pm 3V$ to $\pm 18V$ | ● | 94 | 106 | 94 | 106 | dB | |
| A_{VOL} | Large Signal Voltage Gain | $R_L \geq 2k\Omega$, $V_O = \pm 10V$ | ● | 200 | 400 | 150 | 400 | V/mV | |
| V_{OUT} | Output Voltage Swing | $R_L \geq 2k\Omega$ | ● | ± 12.0 | ± 12.6 | ± 12.0 | ± 12.6 | V | |

ELECTRICAL CHARACTERISTICS $V_S = \pm 15V$, $T_A = 25^\circ C$, unless otherwise noted.

| SYMBOL | PARAMETER | CONDITIONS | OP-07E | | | OP-07C | | | UNITS |
|-------------------------------------|--|---|--------|--|--|--|--|----------------|-------|
| | | | MIN | TYP | MAX | MIN | TYP | MAX | |
| V_{OS} | Input Offset Voltage | (Note 1) | | 30 | 75 | 60 | 150 | μV | |
| $\frac{\Delta V_{OS}}{\Delta Time}$ | Long Term Input Offset Voltage Stability | (Notes 2 and 3) | | 0.3 | 1.5 | 0.4 | 2.0 | $\mu V/Month$ | |
| I_{OS} | Input Offset Current | | | 0.5 | 3.8 | 0.8 | 6.0 | nA | |
| I_B | Input Bias Current | | | ± 1.2 | ± 4.0 | ± 1.8 | ± 7.0 | nA | |
| e_n | Input Noise Voltage | 0.1Hz to 10Hz (Note 2) | | 0.35 | 0.6 | 0.35 | 0.65 | μV_{P-P} | |
| | Input Noise Voltage Density | $f_o = 10Hz$ $f_o = 100Hz$ (Note 2) $f_o = 1000Hz$ | | 10.3 10.0 9.6 | 18.0 13.0 11.0 | 10.5 10.2 9.8 | 20.0 13.5 11.5 | nV/\sqrt{Hz} | |
| I_n | Input Noise Current | 0.1Hz to 10Hz (Note 2) | | 14 | 30 | 15 | 35 | pA_{P-P} | |
| | Input Noise Current Density | $f_o = 10Hz$ $f_o = 100Hz$ (Note 2) $f_o = 1000Hz$ | | 0.32 0.14 0.12 | 0.80 0.23 0.17 | 0.32 0.15 0.13 | 0.90 0.27 0.18 | pA/\sqrt{Hz} | |
| R_{in} | Input Resistance Differential Mode | (Note 4) | | 15 | 50 | 8 | 33 | M Ω | |
| | Input Resistance Common Mode | | | 160 | | 120 | | G Ω | |
| | Input Voltage Range | | | ± 13.5 | ± 14.0 | ± 13.0 | ± 14.0 | V | |
| CMRR | Common Mode Rejection Ratio | $V_{CM} = \pm 13V$ | | 106 | 123 | 100 | 120 | dB | |
| PSRR | Power Supply Rejection Ratio | $V_S = \pm 3V$ to $\pm 18V$ | | 94 | 106 | 90 | 104 | dB | |
| A_{VOL} | Large Signal Voltage Gain | $R_L \geq 2k\Omega$, $V_O = \pm 10V$ $R_L \geq 500\Omega$, $V_O = \pm 0.5V$ $V_S = \pm 3V$ (Note 4) | | 200 150 | 500 400 | 120 100 | 400 400 | V/mV | |
| V_O | Maximum Output Voltage Swing | $R_L \geq 10k\Omega$ $R_L \geq 2k\Omega$ $R_L \geq 1k\Omega$ | | ± 12.5 ± 12.0 ± 10.5 | ± 13.0 ± 12.8 ± 12.0 | ± 12.5 ± 11.5 ± 12.0 | ± 13.0 ± 12.8 ± 12.0 | V | |
| SR | Slewing Rate | $R_L \geq 2k\Omega$ (Note 2) | | 0.1 | 0.25 | 0.1 | 0.25 | V/ μS | |
| GBW | Closed Loop Bandwidth | $A_{VCL} = +1$ (Note 2) | | 0.4 | 0.6 | 0.4 | 0.6 | MHz | |
| Z_o | Open Loop Output Impedance | $V_O = 0$, $I_O = 0$, $f = 10Hz$ | | 60 | | 60 | | Ω | |
| P_d | Power Dissipation | $V_S = \pm 15V$ $V_S = \pm 3V$ | | 75 4 | 120 6 | 80 4 | 150 8 | mW mW | |
| | Offset Adjustment Range | Null Pot = 20k Ω | | ± 4 | | ± 4 | | mV | |

See Notes on page 2-210.



ELECTRICAL CHARACTERISTICS $V_S = \pm 15V$, $0^\circ C \leq T_A \leq 70^\circ C$, unless otherwise noted.

| SYMBOL | PARAMETER | CONDITIONS | OP-07E | | | OP-07C | | | UNITS |
|-------------------------------------|---|---------------------------------------|--------|------------|------------|--------|------------|------------|------------------|
| | | | MIN | TYP | MAX | MIN | TYP | MAX | |
| V_{OS} | Input Offset Voltage | | ● | 45 | 130 | | 85 | 250 | μV |
| $\frac{\Delta V_{OS}}{\Delta Temp}$ | Average Input Offset Voltage Drift Without External Trim With External Trim | Null Pot = 20k Ω (Note 2) | ● | 0.3 0.3 | 1.3 1.3 | | 0.5 0.4 | 1.8 1.6 | $\mu V/^\circ C$ |
| I_{OS} | Input Offset Current | | ● | 0.9 | 5.3 | | 1.6 | 8.0 | nA |
| $\frac{\Delta I_{OS}}{\Delta Temp}$ | Average Input Offset Current Drift | (Note 2) | ● | 8 | 35 | | 12 | 50 | $\mu A/^\circ C$ |
| I_B | Input Bias Current | | ● | ± 1.5 | ± 5.5 | | ± 2.2 | ± 9.0 | nA |
| $\frac{\Delta I_B}{\Delta Temp}$ | Average Input Bias Current Drift | (Note 2) | ● | 13 | 35 | | 18 | 50 | $\mu A/^\circ C$ |
| | Input Voltage Range | | ● | ± 13.0 | ± 13.5 | | ± 13.0 | ± 13.5 | V |
| CMRR | Common Mode Rejection Ratio | $V_{CM} = \pm 13V$ | ● | 103 | 123 | | 97 | 120 | dB |
| PSRR | Power Supply Rejection Ratio | $V_S = \pm 3V$ to $\pm 18V$ | ● | 90 | 104 | | 86 | 100 | dB |
| A_{VOL} | Large Signal Voltage Gain | $R_L \geq 2k\Omega$, $V_o = \pm 10V$ | ● | 180 | 450 | | 100 | 400 | V/mV |
| V_{OUT} | Output Voltage Swing | $R_L \geq 2k\Omega$ | ● | ± 12.0 | ± 12.6 | | ± 11.0 | ± 12.6 | V |

The ● denotes the specifications which apply over full operating temperature range.

For MIL-STD components, please refer to LTC 883C data sheet for test listing and parameters.

Note 1: Offset voltage for the OP-07A is measured 60 seconds after power is applied. All other grades are measured with high speed test equipment, approximately 1 second after power is applied.

Note 2: This parameter is tested on a sample basis only.

Note 3: Long term Input Offset Voltage Stability refers to the averaged trend line of V_{OS} versus Time over extended periods after the first 30 days of operation. Excluding the initial hour of operation, changes in V_{OS} during the first 30 operating days are typically $2.5\mu V$.

Note 4: This parameter is guaranteed by design.

Note 5: The OP-07D is available by special request.

TYPICAL PERFORMANCE CHARACTERISTICS

Low Frequency Noise
(Closed Loop Gain = 25,000)

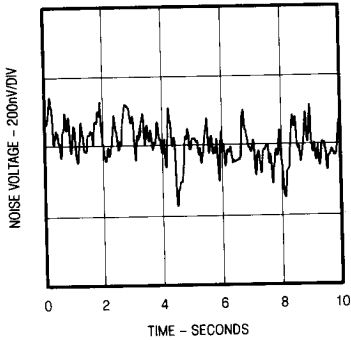

Total Input Noise Voltage vs Frequency

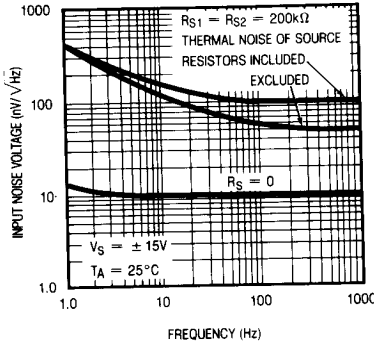

Open-Loop Frequency Response

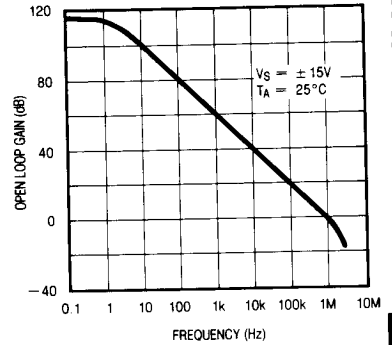

Common Mode Rejection Ratio vs Frequency

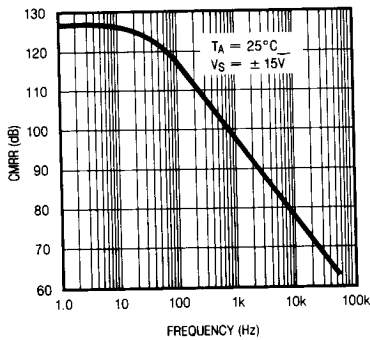

Power Supply Rejection Ratio vs Frequency

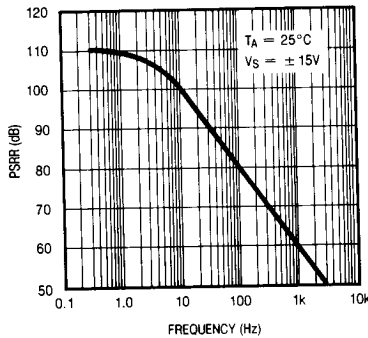

Long Term Stability of Four Representative Units

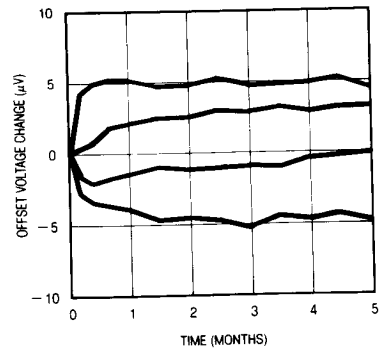

Warm-Up Drift

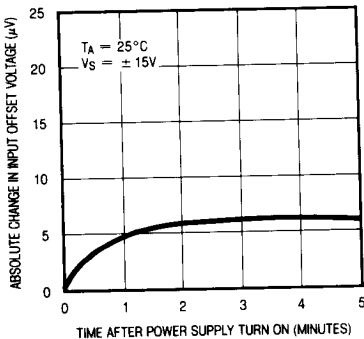

Offset Voltage Change Due to Thermal Shock

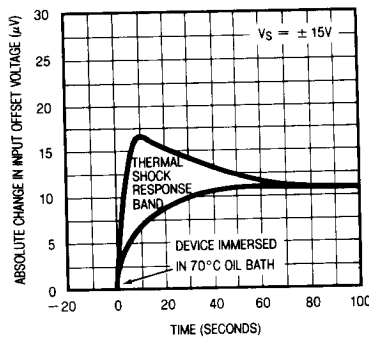

Open-Loop Gain vs Temperature

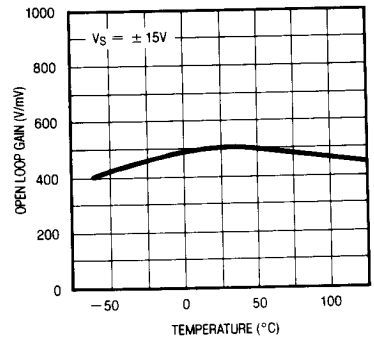

TYPICAL PERFORMANCE CHARACTERISTICS

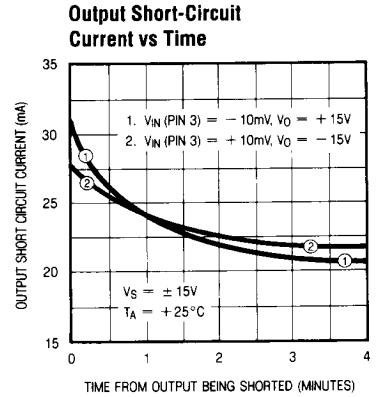
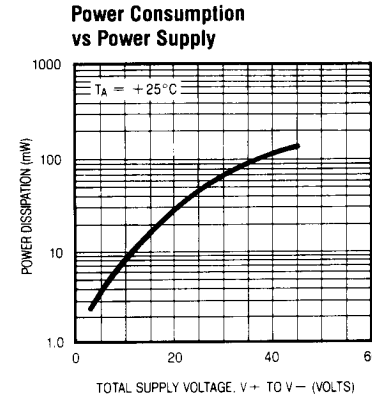
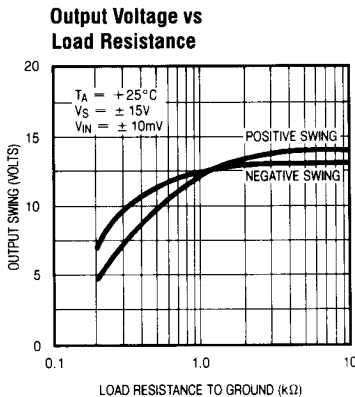
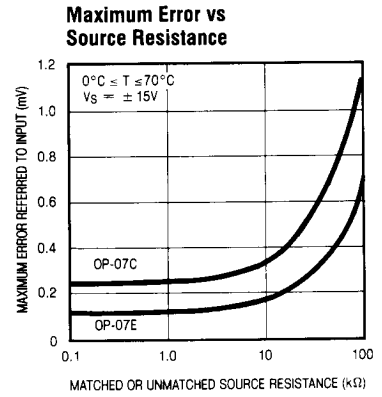
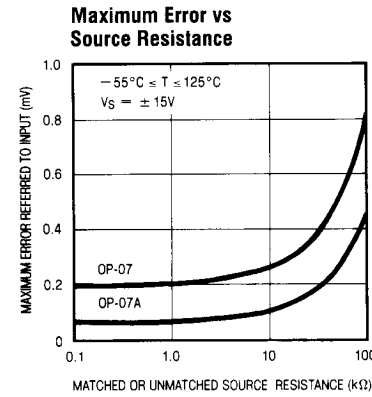
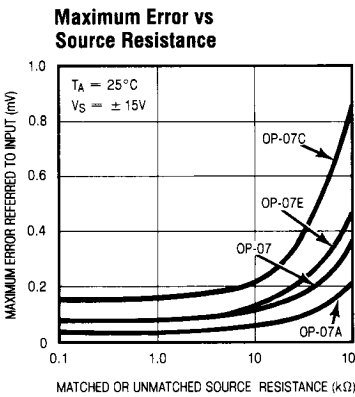
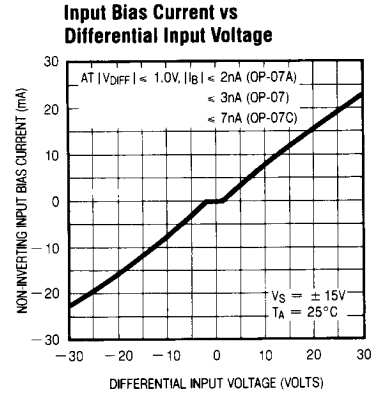
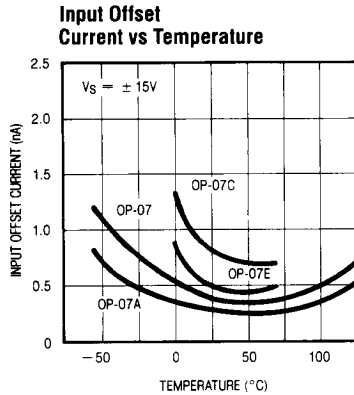
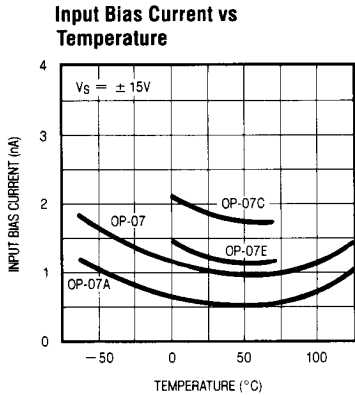

TYPICAL APPLICATIONS

Precision Summing Amplifier

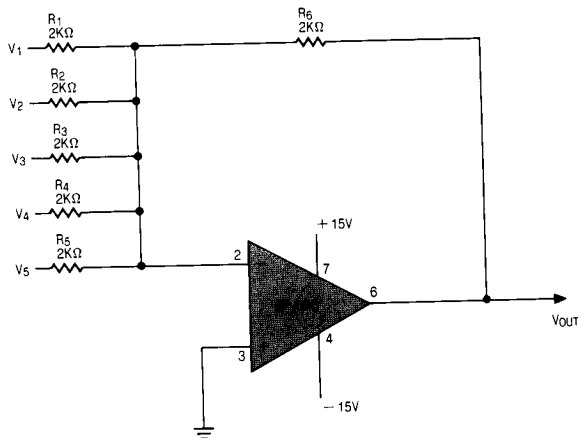

Instrumentation Amplifier

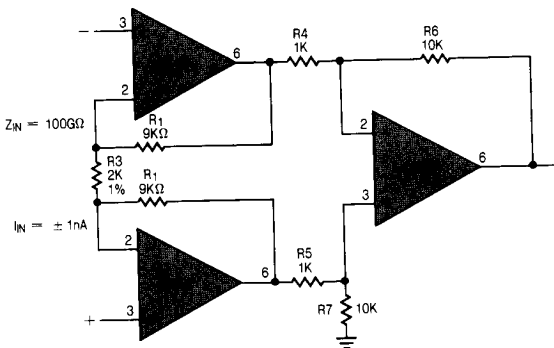

$$A_v = \frac{R6}{R4} \left(\frac{2R1}{R3} + 1 \right)$$

$$A_v = 100$$

TEST CIRCUIT DIAGRAMS

Offset Voltage Test Circuit †

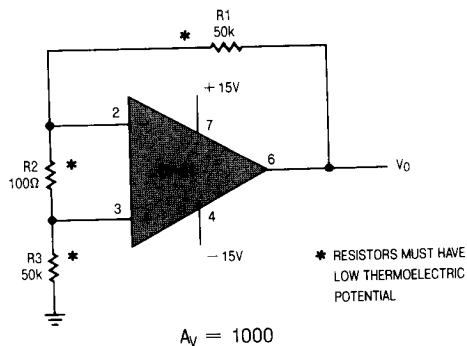

$$A_v = 1000$$

Offset Nulling and Low Frequency Noise Test Circuit

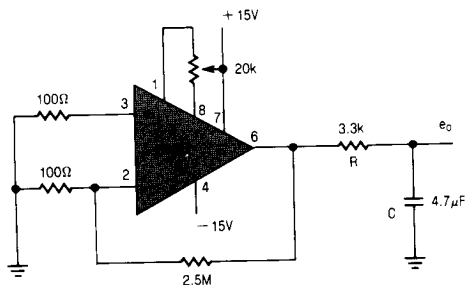

NOTES:

- 1) RC APPROXIMATELY 10Hz FILTER
 - 2) OBSERVE OUTPUT FOR 10 SECONDS
- $$A_v = 25000$$

Application Tip:

When the OP-07 is used as a replacement in 725, 108/108A, 308/308A applications, removal of external compensation is optional. For conventionally nulled 741 type applications, external trimming should be removed. Care should be taken to avoid thermocouple voltages caused by temperature variations between the input terminals or dissimilar metals.

† This circuit is also used as the burn-in configuration with supply voltages changed to ±20V, R1 = R3 = 10k, R2 = 200Ω, Av = 100.

SCHEMATIC DIAGRAM

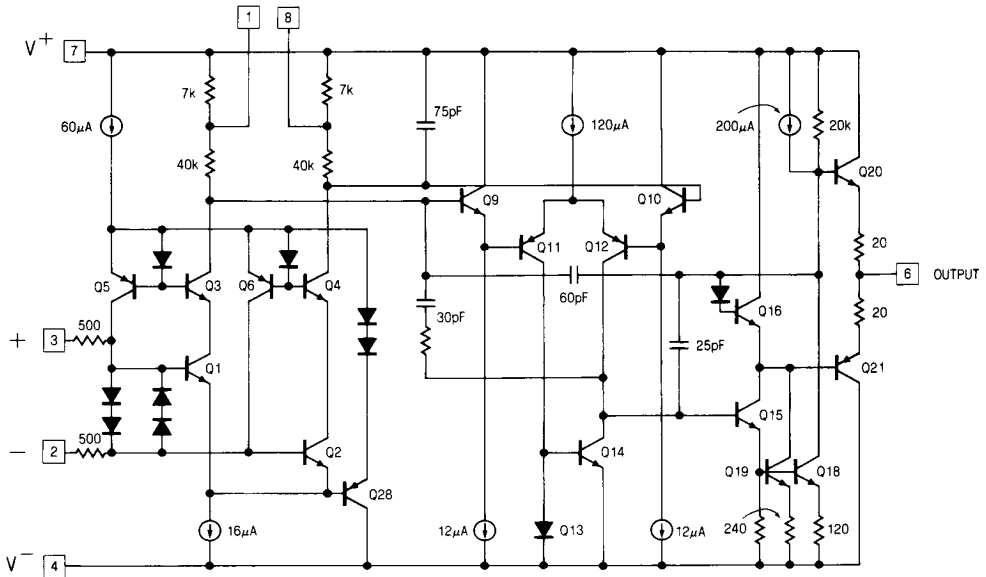

PACKAGE DESCRIPTION

H Package
Metal Can

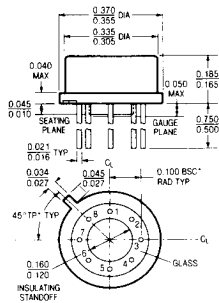

NOTE: DIMENSIONS IN INCHES

| | | |
|-----------|---------------|---------------|
| T_{max} | θ_{ja} | θ_{jc} |
| 150°C | 150°C/W | 45°C/W |

J8 Package
8 Lead Hermetic Dip

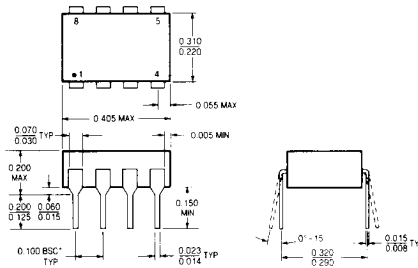

NOTE: DIMENSIONS IN INCHES UNLESS OTHERWISE NOTED
LEADS WITHIN 0.007 OF TRUE POSITION (TPI) AT GAUGE PLANE

| | |
|-----------|---------------|
| T_{max} | θ_{ja} |
| 150°C | 100°C/W |

N8 Package
8 Lead Plastic

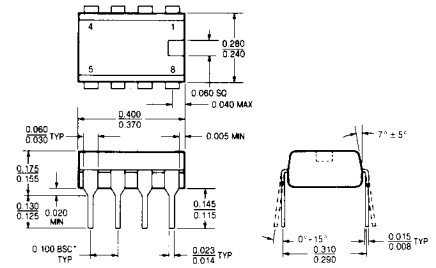

NOTE: DIMENSIONS IN INCHES UNLESS OTHERWISE NOTED
LEADS WITHIN 0.007 OF TRUE POSITION (TPI) AT GAUGE PLANE

| | |
|-----------|---------------|
| T_{max} | θ_{ja} |
| 100°C | 130°C/W |