

The RF MOSFET Line
RF Power Field Effect Transistors
N-Channel Enhancement-Mode Lateral MOSFETs

MRF19045LR3
MRF19045LSR3

Designed for PCN and PCS base station applications with frequencies from 1.9 to 2.0 GHz. Suitable for TDMA, CDMA and multicarrier amplifier applications.

- Typical CDMA Performance @ 1960 MHz, 26 Volts, $I_{DQ} = 550$ mA
 Multi-carrier CDMA Pilot, Sync, Paging, Traffic Codes 8 Through 13
 Output Power — 9.5 Watts Avg.
 Power Gain — 14.9 dB
 Efficiency — 23.5%
 Adjacent Channel Power —
 885 kHz: -50 dBc @ 30 kHz BW
 IM3 — -37 dBc
- 100% Tested Under 2-Carrier N-CDMA
- Internally Matched, Controlled Q, for Ease of Use
- High Gain, High Efficiency and High Linearity
- Integrated ESD Protection
- Designed for Maximum Gain and Insertion Phase Flatness
- Capable of Handling 5:1 VSWR, @ 26 Vdc, 1.93 GHz, 45 Watts CW Output Power
- Excellent Thermal Stability
- Characterized with Series Equivalent Large-Signal Impedance Parameters
- Low Gold Plating Thickness on Leads, 40 μ Nominal.
- In Tape and Reel. R3 Suffix = 250 Units per 32 mm, 13 Inch Reel.

1990 MHz, 45 W, 26 V
LATERAL N-CHANNEL
RF POWER MOSFETS

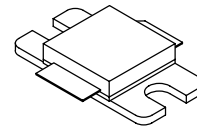

CASE 465E-04, STYLE 1
NI-400
MRF19045LR3

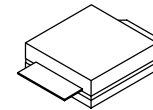

CASE 465F-04, STYLE 1
NI-400S
MRF19045LSR3

MAXIMUM RATINGS

Rating	Symbol	Value	Unit
Drain-Source Voltage	V_{DSS}	65	Vdc
Gate-Source Voltage	V_{GS}	-0.5, +15	Vdc
Total Device Dissipation @ $T_C = 25^\circ\text{C}$ Derate above 25 $^\circ\text{C}$	P_D	105 0.60	Watts W/ $^\circ\text{C}$
Storage Temperature Range	T_{stg}	- 65 to +150	$^\circ\text{C}$
Operating Junction Temperature	T_J	200	$^\circ\text{C}$

THERMAL CHARACTERISTICS

Characteristic	Symbol	Value (1)	Unit
Thermal Resistance, Junction to Case	$R_{\theta JC}$	1.65	$^\circ\text{C}/\text{W}$

ESD PROTECTION CHARACTERISTICS

Test Conditions	Class
Human Body Model	2 (Minimum)
Machine Model	M3 (Minimum)

(1) Refer to AN1955/D, *Thermal Measurement Methodology of RF Power Amplifiers*. Go to <http://www.motorola.com/semiconductors/rf>. Select Documentation/Application Notes - AN1955.

NOTE - CAUTION - MOS devices are susceptible to damage from electrostatic charge. Reasonable precautions in handling and packaging MOS devices should be observed.

Freescale Semiconductor, Inc.

ELECTRICAL CHARACTERISTICS (T_C = 25°C unless otherwise noted)

Characteristic	Symbol	Min	Typ	Max	Unit
OFF CHARACTERISTICS					
Drain-Source Breakdown Voltage (V _{GS} = 0 Vdc, I _D = 100 μAdc)	V _{(BR)DSS}	65	—	—	Vdc
Zero Gate Voltage Drain Current (V _{DS} = 26 Vdc, V _{GS} = 0 Vdc)	I _{DSS}	—	—	10	μAdc
Gate-Source Leakage Current (V _{GS} = 5 Vdc, V _{DS} = 0 Vdc)	I _{GSS}	—	—	1	μAdc
ON CHARACTERISTICS (DC)					
Gate Threshold Voltage (V _{DS} = 10 Vdc, I _D = 100 μAdc)	V _{GS(th)}	2	—	4	Vdc
Gate Quiescent Voltage (V _{DS} = 26 Vdc, I _D = 550 mAdc)	V _{GS(Q)}	3	3.8	5	Vdc
Drain-Source On-Voltage (V _{GS} = 10 Vdc, I _D = 1 Adc)	V _{DS(on)}	—	0.19	0.21	Vdc
Forward Transconductance (V _{DS} = 10 Vdc, I _D = 2 Adc)	g _{fs}	—	4.2	—	S
DYNAMIC CHARACTERISTICS					
Reverse Transfer Capacitance (1) (V _{DS} = 26 Vdc, V _{GS} = 0, f = 1.0 MHz)	C _{rss}	—	1.8	—	pF
FUNCTIONAL TESTS (In Motorola Test Fixture, 50 ohm system) 2-carrier N-CDMA, 1.2288 MHz Channel Bandwidth, IM3 measured in 1.2288 MHz Integrated Bandwidth. ACPR measured in 30 kHz Integrated Bandwidth.					
Common-Source Amplifier Power Gain (V _{DD} = 26 Vdc, P _{out} = 9.5 W Avg, 2-Carrier N-CDMA, I _{DQ} = 550 mA, f ₁ = 1930 MHz, f ₂ = 1932.5 MHz and f ₁ = 1987.5 MHz, f ₂ = 1990 MHz)	G _{ps}	13	14.5	—	dB
Drain Efficiency (V _{DD} = 26 Vdc, P _{out} = 9.5 W Avg, 2-Carrier N-CDMA, I _{DQ} = 550 mA, f ₁ = 1930 MHz, f ₂ = 1932.5 MHz and f ₁ = 1987.5 MHz, f ₂ = 1990 MHz)	η	21	23.5	—	%
3rd Order Intermodulation Distortion (V _{DD} = 26 Vdc, P _{out} = 9.5 W Avg, 2-Carrier N-CDMA, I _{DQ} = 550 mA, f ₁ = 1930 MHz, f ₂ = 1932.5 MHz and f ₁ = 1987.5 MHz, f ₂ = 1990 MHz; IM3 Measured in a 1.2288 MHz Integrated Bandwidth Centered at f ₁ -2.5 Mhz and f ₂ +2.5 MHz, Referenced to the Carrier Channel Power)	IM3	—	-37	-35	dBc
Adjacent Channel Power Ratio (V _{DD} = 26 Vdc, P _{out} = 9.5 W Avg, 2-carrier N-CDMA, I _{DQ} = 550 mA, f ₁ = 1930 MHz, f ₂ = 1932.5 MHz and f ₁ = 1987.5 MHz, f ₂ = 1990 MHz; ACPR measured in a 30 kHz Integrated Bandwidth Centered at f ₁ -885 kHz and f ₂ +885 kHz)	ACPR	—	-51	-45	dBc
Input Return Loss (V _{DD} = 26 Vdc, P _{out} = 9.5 W Avg, 2-Carrier N-CDMA, I _{DQ} = 550 mA, f ₁ = 1930 MHz, f ₂ = 1932.5 MHz and f ₁ = 1987.5 MHz, f ₂ = 1990 MHz)	IRL	—	-16	-9	dB
P _{out} 1 dB Compression Point (V _{DD} = 26 Vdc, I _{DQ} = 550 mA, f = 1990 MHz)	P1dB	—	45	—	W
Output Mismatch Stress (V _{DD} = 26 Vdc, P _{out} = 45 W CW, I _{DQ} = 550 mA, f = 1930 MHz, VSWR = 5:1, All Phase Angles at Frequency of Tests)	Ψ	No Degradation In Output Power Before and After Test			

(1) Part is internally matched both on input and output.

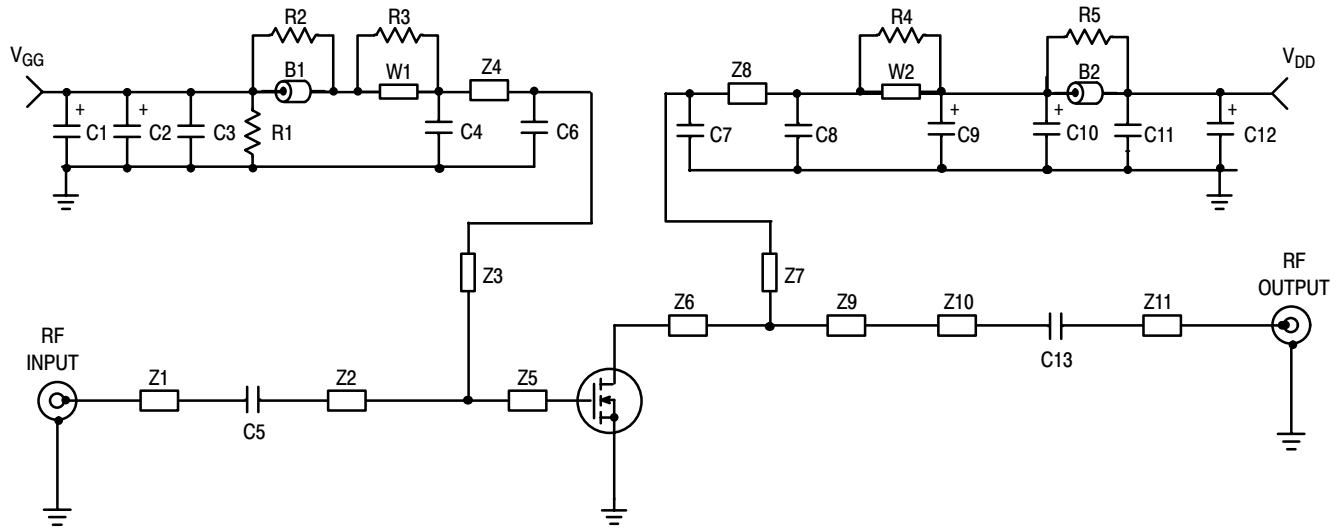

Z1	1.336" x 0.081" Microstrip	Z8	0.216" x 0.047" Microstrip
Z2	0.693" x 0.081" Microstrip	Z9	0.519" x 0.254" Microstrip
Z3	1.033" x 0.047" Microstrip	Z10	0.874" x 0.081" Microstrip
Z4	0.468" x 0.047" Microstrip	Z11	0.645" x 0.081" Microstrip
Z5	0.271" x 0.460" Microstrip	PCB	Arlon GX0300-55-22, 30 mils, $\epsilon_r = 2.55$
Z6	0.263" x 0.930" Microstrip		
Z7	1.165" x 0.047" Microstrip		

NOTE: Z3, Z4, Z7, Z8 lengths and component placement tolerances are $\pm 0.050''$.
 Zx lengths are microstrip lengths between components, center-line to center-line.
 All component and z-length tolerances are $\pm 0.015''$, except as noted.

Figure 1. 1930 - 1990 MHz 2-Carrier N-CDMA Test Circuit Schematic

Table 1. 1930 - 1990 MHz 2-Carrier N-CDMA Test Circuit Component Designations and Values

Designators	Description
B1, B2	0.120" x 0.333" x 0.100", Surface Mount Ferrite Beads, Fair Rite #2743019446
C1, C2	10 μ F, 35 V Tantalum Surface Mount Chip Capacitors, Kemet #T495X106K035AS4394
C3, C11	0.1 μ F Chip Capacitors, Kemet #CDR33BX104AKWS
C4, C8	24 pF Chip Capacitors, B Case, ATC #100B240JP500X
C5	470 pF Chip Capacitor, B Case, ATC #100B471JP200X
C6, C7	11 pF Chip Capacitors, B Case, ATC #100B110JP500X
C9, C10, C12	22 μ F, 35 V Tantalum Surface Mount Chip Capacitors, Kemet #T491X226K035AS4394
C13	8.2 pF Chip Capacitor, B Case, ATC #100B8R2CP500X
R1	560 k Ω , 1/4 W Chip Resistor (0.08" x 0.13")
R2, R3, R4, R5	8.2 Ω , 1/4 W Chip Resistors (0.08" x 0.13"), Garrett Instruments #RM73B2B110JT
W1, W2	Solid Copper Buss Wire, 16 AWG
WS1, WS2	Beryllium Copper Wear Blocks (0.005" x 0.150" x 0.350") Nominal

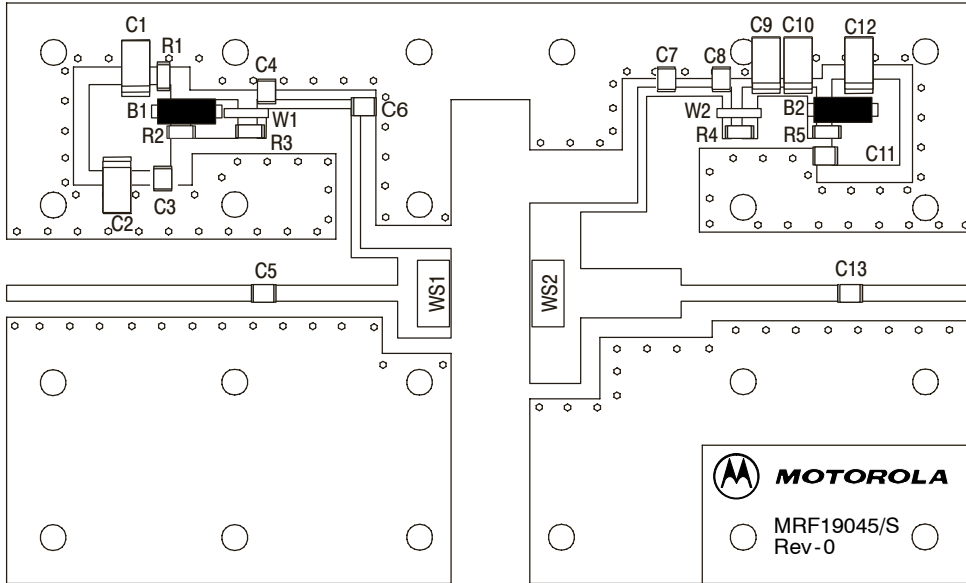

Figure 2. 1930 - 1990 MHz 2-Carrier N-CDMA Test Circuit Component Layout

TYPICAL CHARACTERISTICS

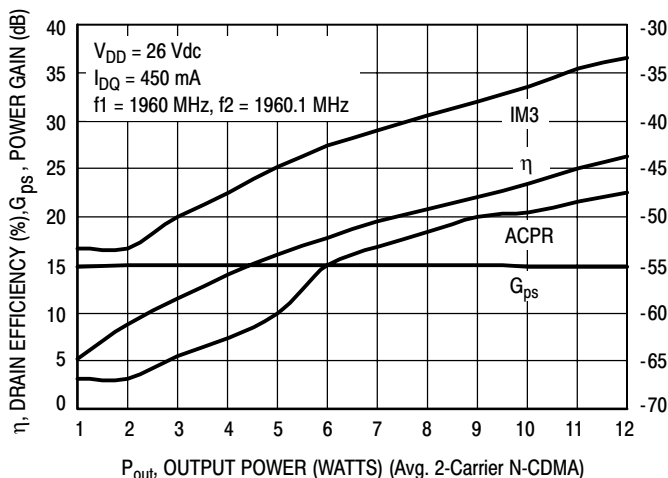

Figure 3. 2-Carrier N-CDMA ACPR, IM3, Power Gain and Drain Efficiency versus Output Power

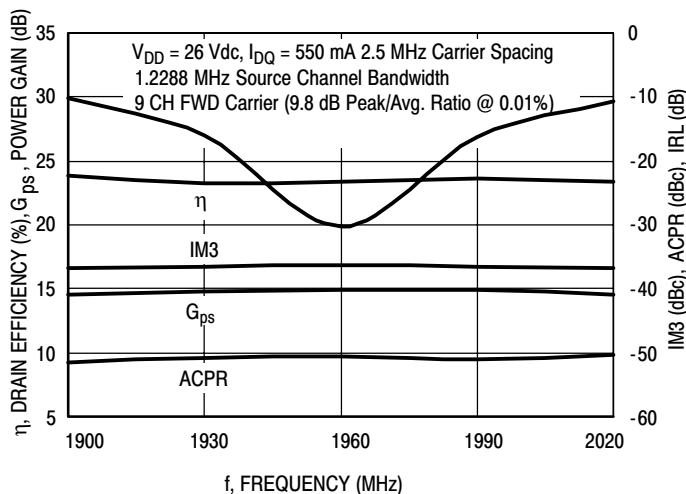

Figure 4. 2-Carrier N-CDMA ACPR, IM3, Power Gain, IRL and Drain Efficiency versus Output Power

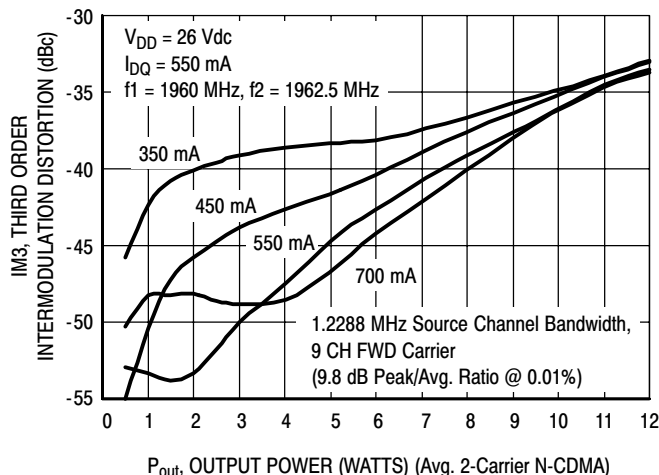

Figure 5. 2-Carrier N-CDMA IM3 versus Output Power

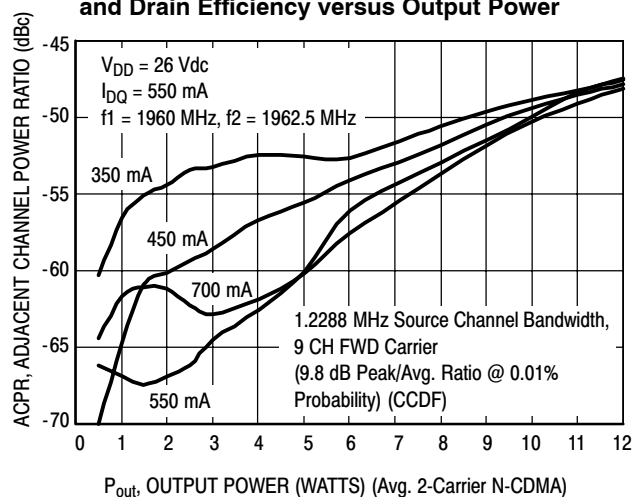

Figure 6. 2-Carrier N-CDMA ACPR versus Output Power

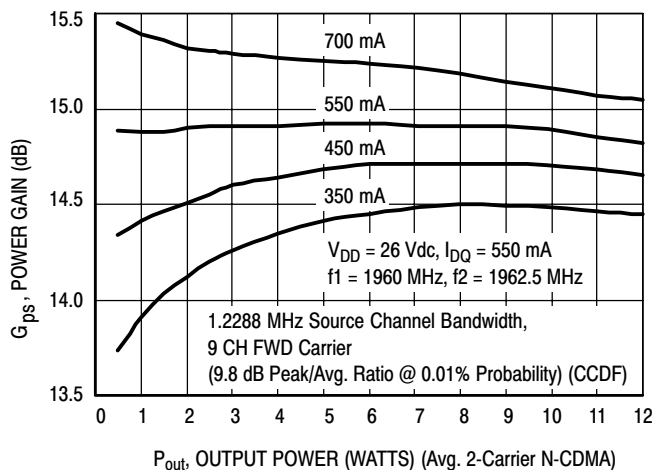

Figure 7. 2-Carrier N-CDMA Power Gain versus Output Power

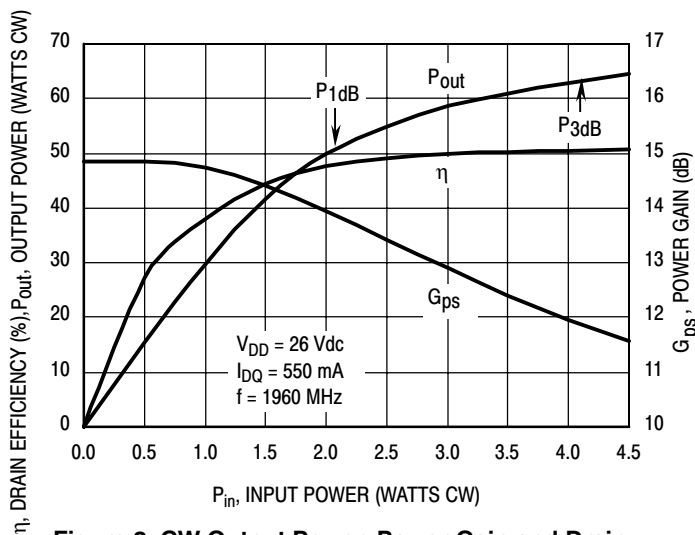

Figure 8. CW Output Power, Power Gain and Drain Efficiency versus Input Power

TYPICAL CHARACTERISTICS

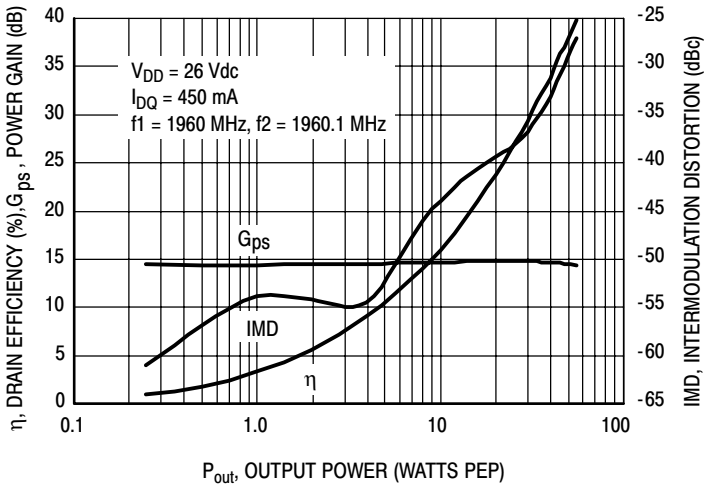

Figure 9. CW Two-Tone Power Gain, IMD and Drain Efficiency versus Output Power

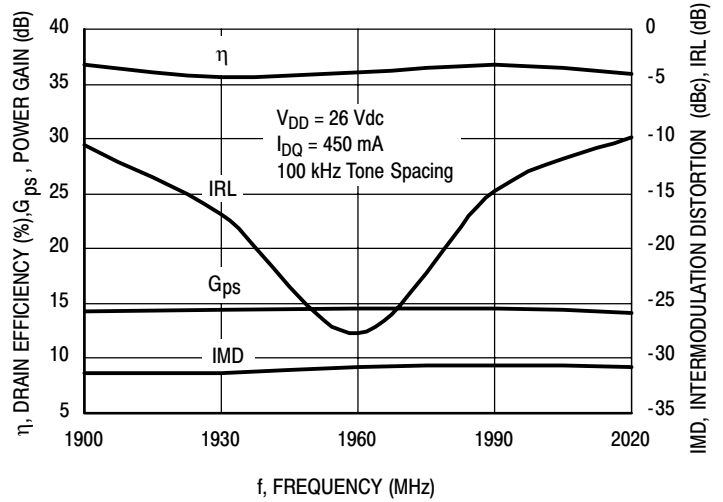

Figure 10. CW Two-Tone Power Gain, Input Return Loss, IMD and Drain Efficiency versus Frequency

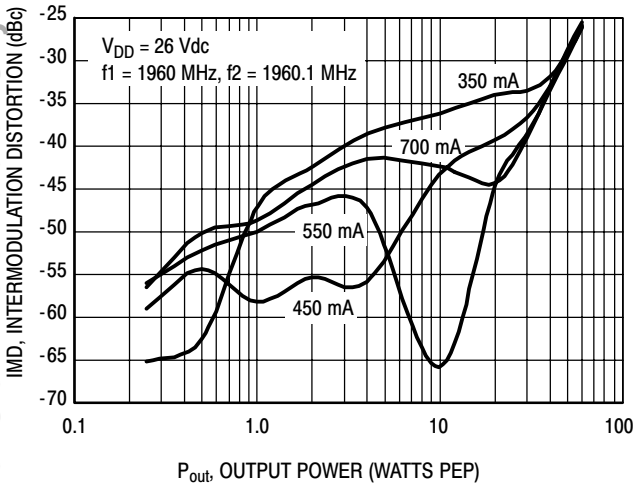

Figure 11. CW Two-Tone Intermodulation Distortion versus Output Power

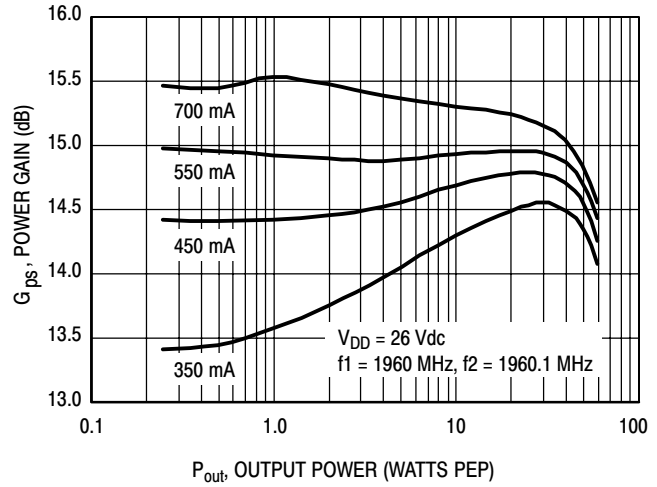

Figure 12. CW Two-Tone Power Gain versus Output Power

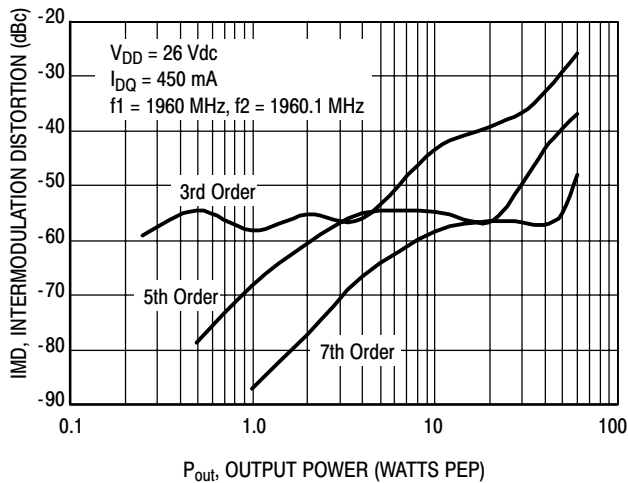

Figure 13. CW Two-Tone Intermodulation Distortion Products versus Output Power

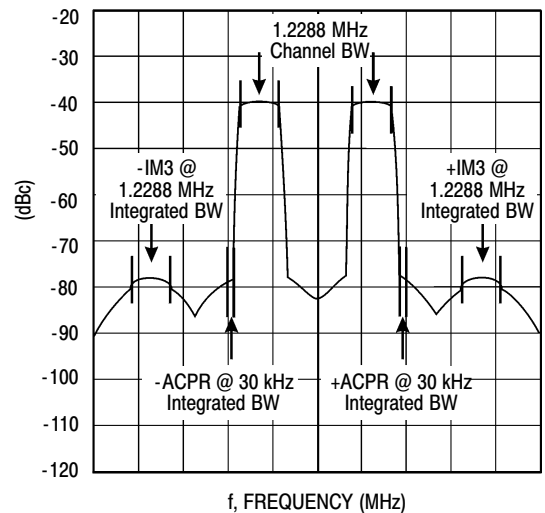
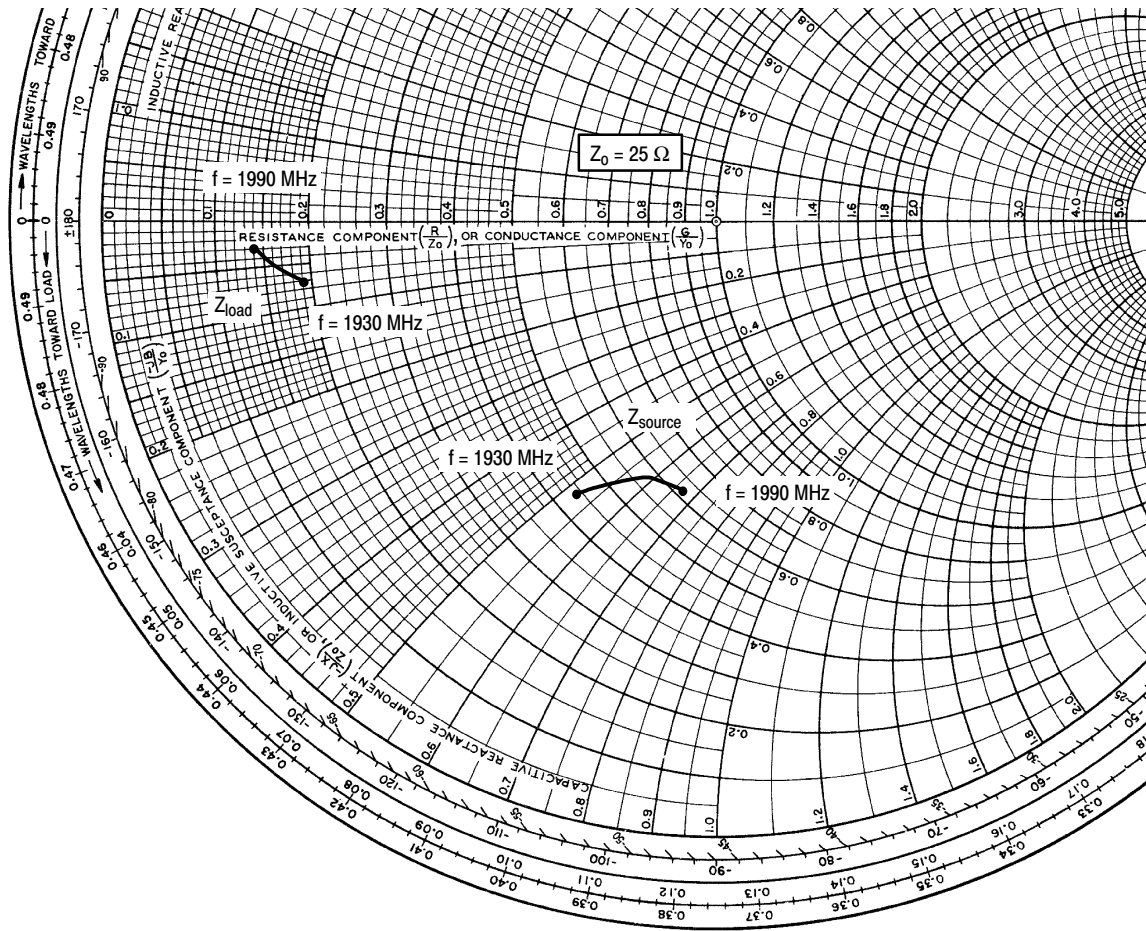

Figure 14. 2-Carrier N-CDMA Spectrum



$V_{DD} = 26\text{ V}$, $I_{DQ} = 550\text{ mA}$, $P_{out} = 9\text{ W Avg.}$, 2-Carrier N-CDMA

f MHz	Z_{source} Ω	Z_{load} Ω
1930	15.52 - j16.5	4.52 - j1.86
1960	14.24 - j14.44	3.85 - j1.04
1990	11.11 - j13.01	3.44 - j0.69

Z_{source} = Test circuit impedance as measured from gate to ground.

Z_{load} = Test circuit impedance as measured from drain to ground.

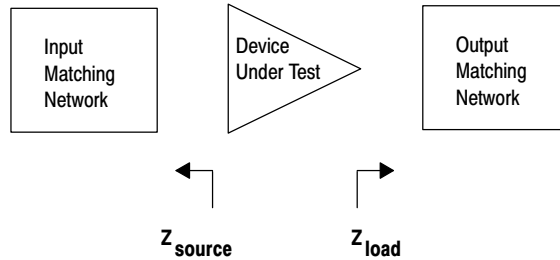

Figure 15. Series Equivalent Source and Load Impedance

NOTES

NOTES

NOTES

Freescale Semiconductor, Inc.

PACKAGE DIMENSIONS

SEE NOTE 4

2X \varnothing Q

2X K

2X D

N (LID)

R (LID)

(INSULATOR)

(INSULATOR)

SEATING PLANE

H

CASE 465E-04
ISSUE E
NI-400
MRF19045LR3

NOTES:

1. CONTROLLING DIMENSION: INCH.
2. INTERPRET DIMENSIONS AND TOLERANCES PER ASME Y14.5M, 1994.
3. DIMENSION H IS MEASURED 0.030 (0.762) AWAY FROM PACKAGE BODY.
4. INFORMATION ONLY: CORNER BREAK (4X) TO BE .060±.005 (1.52±0.13) RADIUS OR .06±.005 (1.52±0.13) x 45° CHAMFER.

DIM	INCHES		MILLIMETERS	
	MIN	MAX	MIN	MAX
A	.795	.805	20.19	20.44
B	.380	.390	9.65	9.9
C	.125	.163	3.17	4.14
D	.275	.285	6.98	7.24
E	.035	.045	0.89	1.14
F	.004	.006	0.10	0.15
G	.600 BSC		15.24 BSC	
H	.057	.067	1.45	1.7
K	.092	.122	2.33	3.1
M	.395	.405	10	10.3
N	.395	.405	10	10.3
Q	\varnothing .120	\varnothing .130	\varnothing 3.05	\varnothing 3.3
R	.395	.405	10	10.3
S	.395	.405	10	10.3
aaa	.005 BSC		0.127 BSC	
bbb	.010 BSC		0.254 BSC	
ccc	.015 BSC		0.381 BSC	

STYLE 1:
 PIN 1. DRAIN
 2. GATE
 3. SOURCE

2X D

2X K

R (LID)

(INSULATOR)

(INSULATOR)

SEATING PLANE

H

CASE 465F-04
ISSUE C
NI-400S
MRF19045LSR3

NOTES:

1. CONTROLLING DIMENSION: INCH.
2. INTERPRET DIMENSIONS AND TOLERANCES PER ASME Y14.5M-1994.
3. DIMENSION H IS MEASURED 0.030 (0.762) AWAY FROM PACKAGE BODY.

DIM	INCHES		MILLIMETERS	
	MIN	MAX	MIN	MAX
A	.395	.405	10.03	10.29
B	.395	.405	10.03	10.29
C	.125	.163	3.18	4.14
D	.275	.285	6.98	7.24
E	.035	.045	0.89	1.14
F	.004	.006	0.10	0.15
H	.057	.067	1.45	1.70
K	.092	.122	2.34	3.10
M	.395	.405	10.03	10.29
N	.395	.405	10.03	10.29
R	.395	.405	10.03	10.29
S	.395	.405	10.03	10.29
aaa	.005 REF		0.127 REF	
bbb	.010 REF		0.254 REF	
ccc	.015 REF		0.38 REF	

STYLE 1:
 PIN 1. DRAIN
 2. GATE
 3. SOURCE

Information in this document is provided solely to enable system and software implementers to use Motorola products. There are no express or implied copyright licenses granted hereunder to design or fabricate any integrated circuits or integrated circuits based on the information in this document.

Motorola reserves the right to make changes without further notice to any products herein. Motorola makes no warranty, representation or guarantee regarding the suitability of its products for any particular purpose, nor does Motorola assume any liability arising out of the application or use of any product or circuit, and specifically disclaims any and all liability, including without limitation consequential or incidental damages. "Typical" parameters that may be provided in Motorola data sheets and/or specifications can and do vary in different applications and actual performance may vary over time. All operating parameters, including "Typicals", must be validated for each customer application by customer's technical experts. Motorola does not convey any license under its patent rights nor the rights of others. Motorola products are not designed, intended, or authorized for use as components in systems intended for surgical implant into the body, or other applications intended to support or sustain life, or for any other application in which the failure of the Motorola product could create a situation where personal injury or death may occur. Should Buyer purchase or use Motorola products for any such unintended or unauthorized application, Buyer shall indemnify and hold Motorola and its officers, employees, subsidiaries, affiliates, and distributors harmless against all claims, costs, damages, and expenses, and reasonable attorney fees arising out of, directly or indirectly, any claim of personal injury or death associated with such unintended or unauthorized use, even if such claim alleges that Motorola was negligent regarding the design or manufacture of the part.

MOTOROLA and the Stylized M Logo are registered in the US Patent and Trademark Office. All other product or service names are the property of their respective owners. Motorola, Inc. is an Equal Opportunity/Affirmative Action Employer.

© Motorola Inc. 2004

HOW TO REACH US:

USA/EUROPE/LOCATIONS NOT LISTED:
Motorola Literature Distribution
P.O. Box 5405, Denver, Colorado 80217
1-800-521-6274 or 480-768-2130

JAPAN: Motorola Japan Ltd.; SPS, Technical Information Center,
3-20-1, Minami-Azabu, Minato-ku, Tokyo 106-8573, Japan
81-3-3440-3569

ASIA/PACIFIC: Motorola Semiconductors H.K. Ltd.; Silicon Harbour Centre,
2 Dai King Street, Tai Po Industrial Estate, Tai Po, N.T., Hong Kong
852-26668334

HOME PAGE: <http://motorola.com/semiconductors>



MOTOROLA

**For More Information On This Product,
Go to: www.freescale.com**

MRF19045/D