

The RF Line
NPN Silicon
RF Power Transistor

MRF858S

CLASS A
800–960 MHz
3.6 W (CW), 24 V
NPN SILICON
RF POWER TRANSISTOR

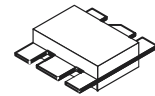

CASE 319A-02, STYLE 2

Designed for 24 Volt UHF large-signal, common emitter, class A linear amplifier applications in industrial and commercial equipment operating in the range of 800–960 MHz.

- Specified for $V_{CE} = 24$ Vdc, $I_C = 0.5$ Adc Characteristics
Output Power = 3.6 Watts CW
Minimum Power Gain = 11 dB
Minimum ITO = +44.5 dBm
Typical Noise Figure = 6 dB
- Characterized with Small-Signal S-Parameters and Series Equivalent Large-Signal Parameters from 800–960 MHz
- Silicon Nitride Passivated
- 100% Tested for Load Mismatch Stress at All Phase Angles with 30:1 VSWR @ 24 Vdc, $I_C = 0.5$ Adc and Rated Output Power
- Will Withstand RF Input Overdrive of 0.85 W CW
- Gold Metallized, Emitter Ballasted for Long Life and Resistance to Metal Migration
- Circuit board photomaster available upon request by contacting RF Tactical Marketing in Phoenix, AZ.

MAXIMUM RATINGS

Rating	Symbol	Value	Unit
Collector–Emitter Voltage	V_{CEO}	30	Vdc
Collector–Base Voltage	V_{CBO}	55	Vdc
Emitter–Base Voltage	V_{EBO}	4	Vdc
Total Device Dissipation @ $T_C = 50^\circ\text{C}$ Derate above 50°C	P_D	20 0.138	Watts W/ $^\circ\text{C}$
Operating Junction Temperature	T_J	200	$^\circ\text{C}$
Storage Temperature Range	T_{stg}	–65 to +150	$^\circ\text{C}$

THERMAL CHARACTERISTICS

Characteristic	Symbol	Max	Unit
Thermal Resistance ($T_J = 150^\circ\text{C}$, $T_C = 50^\circ\text{C}$)	$R_{\theta JC}$	6.9	$^\circ\text{C}/\text{W}$

ELECTRICAL CHARACTERISTICS

Characteristic	Symbol	Min	Typ	Max	Unit
----------------	--------	-----	-----	-----	------

OFF CHARACTERISTICS

Collector–Emitter Breakdown Voltage ($I_C = 20$ mA, $I_B = 0$)	$V_{(BR)CEO}$	28	35	—	Vdc
Collector–Emitter Breakdown Voltage ($I_C = 20$ mA, $V_{BE} = 0$)	$V_{(BR)CES}$	55	85	—	Vdc
Collector–Base Breakdown Voltage ($I_C = 20$ mA, $I_E = 0$)	$V_{(BR)CBO}$	55	85	—	Vdc
Emitter–Base Breakdown Voltage ($I_E = 1$ mA, $I_C = 0$)	$V_{(BR)EBO}$	4	5	—	Vdc
Collector Cutoff Current ($V_{CB} = 24$ V, $I_E = 0$)	I_{CES}	—	—	1	mA

Teflon is a registered trademark of du Pont de Nemours & Co., Inc.



ELECTRICAL CHARACTERISTICS — continued

Characteristic	Symbol	Min	Typ	Max	Unit
ON CHARACTERISTICS					
DC Current Gain ($I_C = 0.1\text{ A}$, $V_{CE} = 5\text{ V}$)	h_{FE}	30	60	120	—
DYNAMIC CHARACTERISTICS					
Output Capacitance ($V_{CB} = 24\text{ V}$, $f = 1\text{ MHz}$)	C_{ob}	—	6.5	8	pF
FUNCTIONAL CHARACTERISTICS					
Common-Emitter Power Gain ($V_{CE} = 24\text{ V}$, $I_C = 0.5\text{ A}$, $f = 840\text{--}900\text{ MHz}$, Power Output = 3.6 W)	P_g	11	12	—	dB
Load Mismatch ($P_o = 3.6\text{ W}$) ($V_{CE} = 24\text{ V}$, $I_C = 0.5\text{ A}$, $f = 840\text{ MHz}$, Load VSWR = 30:1, All Phase Angles)	ψ	No Degradation in Output Power			
RF Input Overdrive ($V_{CE} = 24\text{ V}$, $I_C = 0.5\text{ A}$, $f = 840\text{ MHz}$) No degradation	$P_{in(over)}$	—	—	0.85	W
Third Order Intercept Point ($V_{CE} = 24\text{ V}$, $I_C = 0.5\text{ A}$) ($f_1 = 900\text{ MHz}$, $f_2 = 900.1\text{ MHz}$, Meas. @ IMD 3rd Order = -40 dBc)	ITO	+44.5	+45.5	—	dBm
Noise Figure ($V_{CE} = 24\text{ V}$, $I_C = 0.5\text{ A}$, $f = 900\text{ MHz}$)	NF	—	6	—	dB
Input Return Loss ($V_{CE} = 24\text{ V}$, $I_C = 0.5\text{ A}$, $f = 840\text{--}900\text{ MHz}$, Power Output = 3.6 W)	IRL	—	-12	-9	dB

Table 1. Common Emitter S-Parameters

V_{CE} (V)	I_C (A)	f (MHz)	S_{11}		S_{21}		S_{12}		S_{22}	
			$ S_{11} $	$\angle \phi$	$ S_{21} $	$\angle \phi$	$ S_{12} $	$\angle \phi$	$ S_{22} $	$\angle \phi$
24	0.5	800	0.942	167	1.493	50	0.027	58	0.538	-165
		820	0.942	166	1.453	50	0.027	58	0.541	-164
		840	0.941	166	1.415	49	0.028	59	0.545	-165
		860	0.940	166	1.379	48	0.028	59	0.550	-165
		880	0.941	165	1.351	47	0.029	59	0.553	-165
		900	0.940	165	1.320	46	0.030	59	0.557	-165
		920	0.940	165	1.289	45	0.030	59	0.562	-165
		940	0.940	164	1.252	44	0.031	59	0.566	-165
		960	0.940	164	1.222	43	0.031	59	0.570	-165

Table 2. Z_{in} and Z_{OL}^* versus Frequency

f (MHz)	Z_{in} (Ohms)		Z_{OL}^* (Ohms)	
840	1.1	2.9	9.9	-14.4
870	1.1	3.5	9.5	-14.6
900	1.2	3.5	9	-14.5

$V_{CE} = 24\text{ V}$, $I_C = 0.5\text{ A}$, $P_o = 3.6\text{ W}$

Z_{OL}^* = Conjugate of optimum load impedance into which the device operates at a given output power, voltage and frequency.

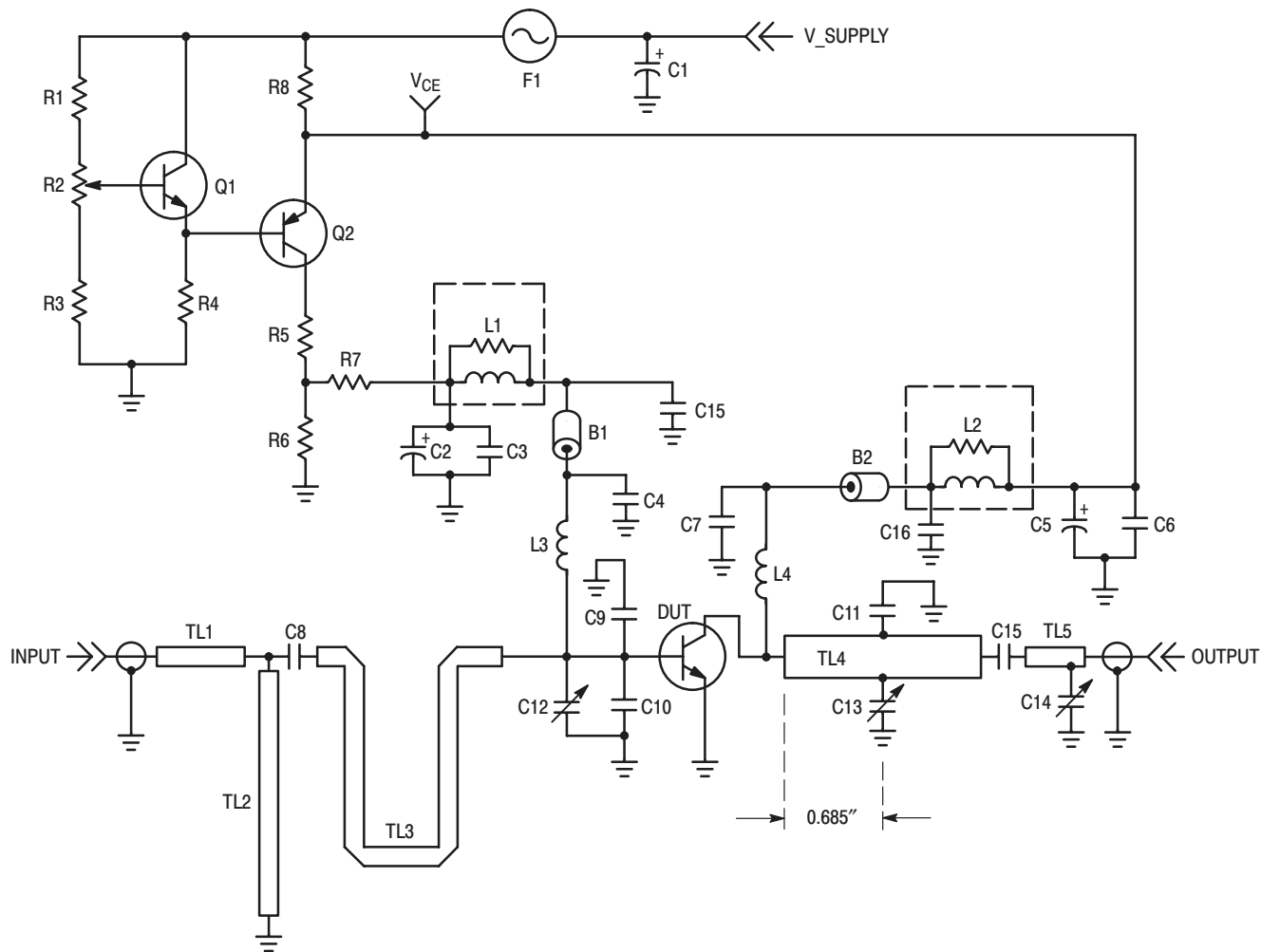

B1, B2	Short Ferrite Bead, Fair Rite (2743021447)	R1	390 Ω, 1/4 W
C1	250 μF, 50 Vdc Electrolytic Capacitor	R2	500 Ω Potentiometer, 1/4 W
C2, C5	10 μF, 50 Vdc Electrolytic Capacitor	R3	7.5K Ω, 1/4 W
C3, C6	0.1 μF, Chip Capacitor	R4	2 x 4.7K Ω, 1/4 W
C4, C7	100 pF, Chip Capacitor	R5	56 Ω, 2 W
C8, C15	43 pF, 100 Mil Chip Capacitor	R6	75 Ω, 1/4 W
C9, C10	10 pF, Mini-Unelco	R7	4.7 Ω, 1/4 W
C11	5 pF, Mini-Unelco	R8	4 Ω, 10 W
C12, C13, C14	0.8–8.0 pF, Johanson Gigatrim	TL1, TL5	50 Ω, Microstrip Transmission Line
C15, C16	1000 pF, Chip Capacitor	TL2	Microstrip Transmission Line
F1	1 A Micro-Fuse	TL3	Microstrip Transmission Line
L1, L2	10 Turns, 20 AWG, 0.150" ID (10 Ω 1/2 W Resistor)	TL4	Microstrip Transmission Line
L3	4 Turns, 16 AWG, 0.101" ID	V_Supply	+26 Vdc ±0.5 Vdc Due to Resistor Tolerance
L4	0.5" 18 AWG Wire	V_CE	+24 Vdc @ 0.5 A
Q1	MMBT2222ALT1, NPN Transistor	Board	0.030" Glass-Teflon® 2 oz. Cu, ε _r = 2.55
Q2	BD136, PNP Transistor		

Figure 1. MRF858S Class A RF Test Fixture Schematic

TYPICAL CHARACTERISTICS

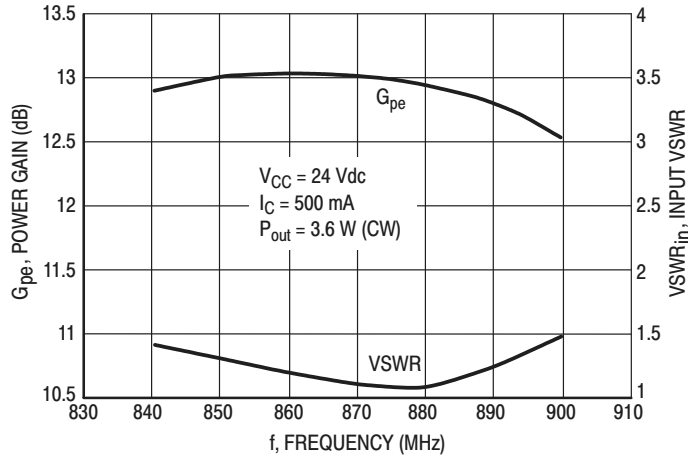

Figure 2. Performance in Broadband Circuit

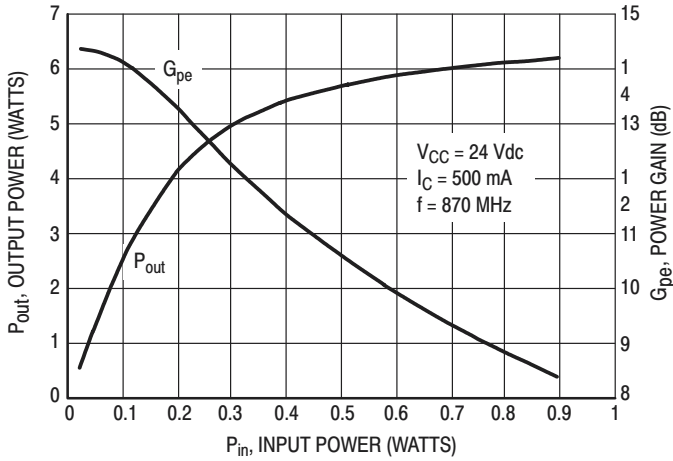

Figure 3. Output Power & Power Gain versus Input Power

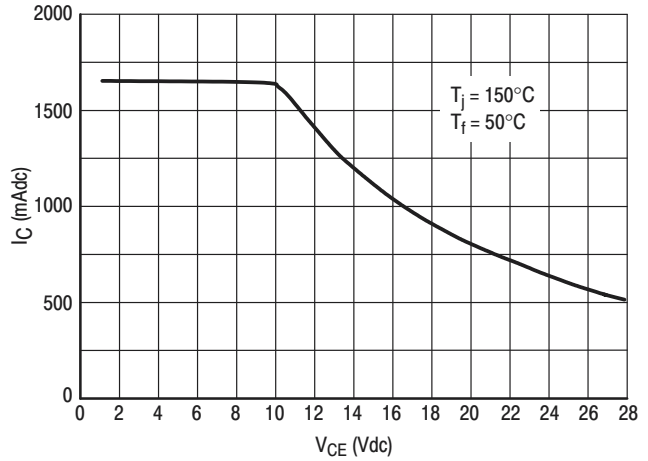

Figure 4. DC SOA

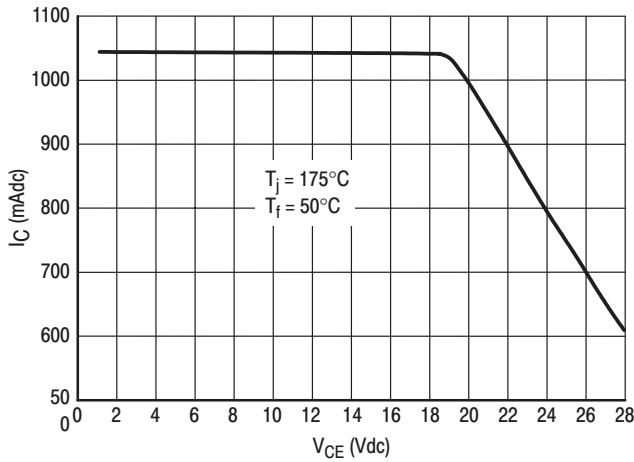

Figure 5. DC SOA
(This device is MTBF limited for $V_{CE} < 20$ Vdc.)

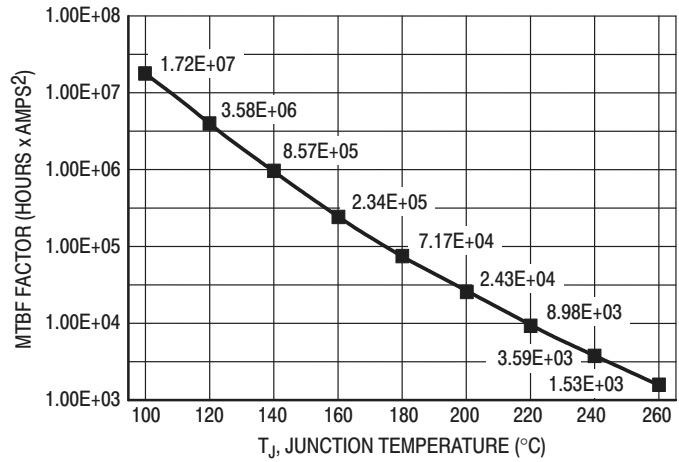

Figure 6. MTBF Factor versus Junction Temperature

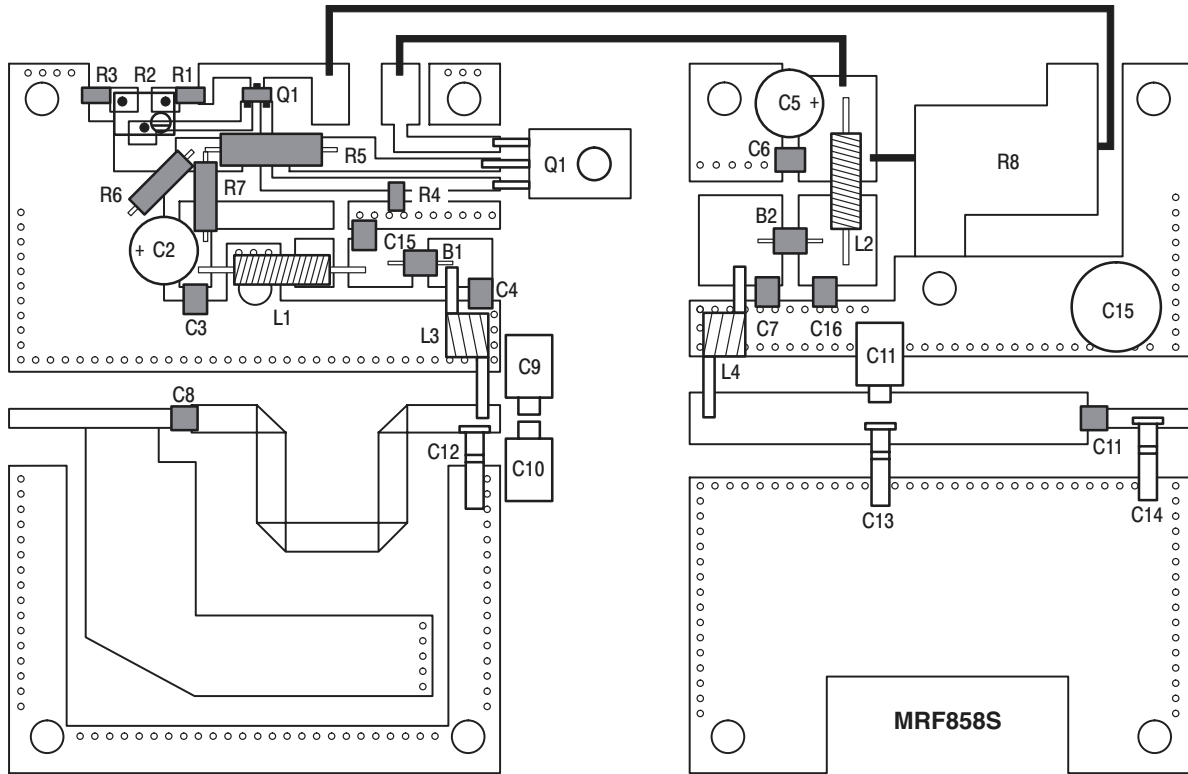
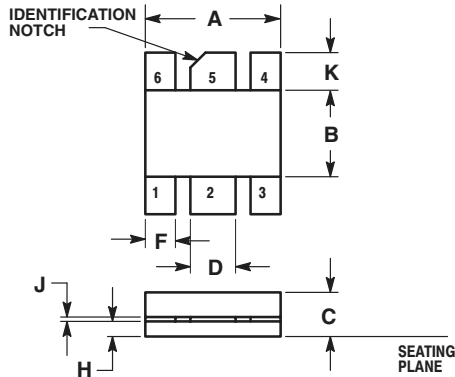

Figure 7. MRF858S Test Fixture Component Layout

PACKAGE DIMENSIONS



- NOTES:
1. DIMENSIONING AND TOLERANCING PER ANSI Y14.5M, 1982.
 2. CONTROLLING DIMENSION: INCH.

DIM	INCHES		MILLIMETERS	
	MIN	MAX	MIN	MAX
A	0.355	0.365	9.02	9.27
B	0.225	0.235	5.72	5.96
C	0.110	0.125	2.80	3.17
D	0.115	0.125	2.93	3.17
F	0.075	0.085	1.91	2.15
H	0.035	0.045	0.89	1.14
J	0.004	0.006	0.11	0.15
K	0.090	0.110	2.29	2.79

- STYLE 2:
- PIN 1. EMITTER
 2. BASE
 3. EMITTER
 4. EMITTER
 5. COLLECTOR
 6. EMITTER

CASE 319A-02 ISSUE B

Motorola reserves the right to make changes without further notice to any products herein. Motorola makes no warranty, representation or guarantee regarding the suitability of its products for any particular purpose, nor does Motorola assume any liability arising out of the application or use of any product or circuit, and specifically disclaims any and all liability, including without limitation consequential or incidental damages. "Typical" parameters which may be provided in Motorola data sheets and/or specifications can and do vary in different applications and actual performance may vary over time. All operating parameters, including "Typicals" must be validated for each customer application by customer's technical experts. Motorola does not convey any license under its patent rights nor the rights of others. Motorola products are not designed, intended, or authorized for use as components in systems intended for surgical implant into the body, or other applications intended to support or sustain life, or for any other application in which the failure of the Motorola product could create a situation where personal injury or death may occur. Should Buyer purchase or use Motorola products for any such unintended or unauthorized application, Buyer shall indemnify and hold Motorola and its officers, employees, subsidiaries, affiliates, and distributors harmless against all claims, costs, damages, and expenses, and reasonable attorney fees arising out of, directly or indirectly, any claim of personal injury or death associated with such unintended or unauthorized use, even if such claim alleges that Motorola was negligent regarding the design or manufacture of the part. Motorola and  are registered trademarks of Motorola, Inc. Motorola, Inc. is an Equal Opportunity/Affirmative Action Employer.

Mfax is a trademark of Motorola, Inc.

How to reach us:

USA/EUROPE/Locations Not Listed: Motorola Literature Distribution;
P.O. Box 5405, Denver, Colorado 80217. 1-303-675-2140 or 1-800-441-2447

JAPAN: Nippon Motorola Ltd.; SPD, Strategic Planning Office, 141,
4-32-1 Nishi-Gotanda, Shinagawa-ku, Tokyo, Japan. 81-3-5487-8488

Customer Focus Center: 1-800-521-6274

Mfax™: RMFAX0@email.sps.mot.com – TOUCHTONE 1-602-244-6609
Motorola Fax Back System – US & Canada ONLY 1-800-774-1848
– http://sps.motorola.com/mfax/

ASIA/PACIFIC: Motorola Semiconductors H.K. Ltd.; 8B Tai Ping Industrial Park,
51 Ting Kok Road, Tai Po, N.T., Hong Kong. 852-26629298

HOME PAGE: <http://motorola.com/sps/>

