

---

# HA12215F

Audio Signal Processor for Cassette Deck  
(Dolby B-type NR with Recording System)

## HITACHI

ADE-207-253D (Z)

Target Specification  
5th Edition  
Oct. 1999

---

### Description

HA12215F is silicon monolithic bipolar IC providing Dolby noise reduction system\*<sup>1</sup>, music sensor system, REC equalizer system and each electronic control switch in one chip.

Note: 1. Dolby is a trademark of Dolby Laboratories Licensing Corporation.

A license from Dolby Laboratories Licensing Corporation is required for the use of this IC.

### Functions

- Dolby B-NR × 2 channel
- REC equalizer × 2 channel
- Music sensor × 1 channel
- Pass amp. × 2 channel
- Each electronic control switch to change REC equalizer, bias, etc.

### Features

- REC equalizer is very small number of external parts and have 6 types of frequency characteristics built-in.
- 2 types of input for PB, 1 type of input for REC.
- 70 $\mu$  - PB equalizer changing system built-in.
- Dolby NR with dubbing double cassette decks.  
Unprocessed signal output available from recording out terminals during PB mode.
- Provide stable music sensor system, available to design music sensing time and level.
- Controllable from direct micro-computer output.
- Bias oscillator control switch built-in.
- NR ON / OFF and REC / PB fully electronic control switching built-in.
- Normal-speed / high-speed, Normal / Crom / Metal and PB equalizer fully electronic control switching built-in.
- Available to reduce substrate-area because of high integration and small external parts.

---

# HA12215F

---

## Ordering Information

### Operating Voltage

Product	V <sub>CC</sub> (V)	V <sub>EE</sub> (V)	Note
HA12215F	+6.0 to +7.5	-7.5 to -6.0	V <sub>CC</sub> + V <sub>EE</sub>   < 1.0 V

### Standard Level

Product	Package	PB-OUT Level	REC-OUT Level	Dolby Level
HA12215F	FP-56	580 mVrms	300 mVrms	300 mVrms

### Function

Product	Dolby B-NR	REC-EQ	Music Sensor	Pass Amp.	REC / PB Selection	ALC
HA12215F	○	○	○	○	○	○

Note: Depending on the employed REC / PB head and test tape characteristics, there is a rare case that the REC-EQ characteristics of this LSI can not be matched to the required characteristics because of built-in resistors which determined the REC-EQ parameters in this case, please inquire the responsible agent because the adjustment built-in resistor is necessary.

**Pin Description, Equivalent Circuit** ( $V_{CC} = \pm 7\text{ V}$ , A system of split supply voltage,  $T_a = 25^\circ\text{C}$ , No Signal, The value in the show typical value.)

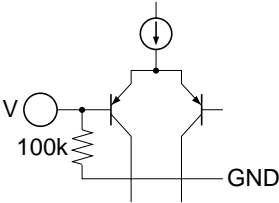
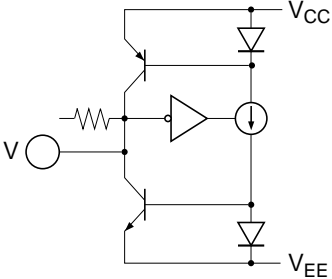
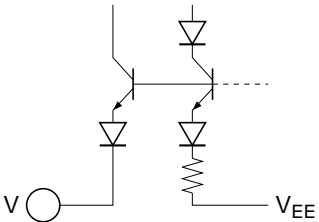
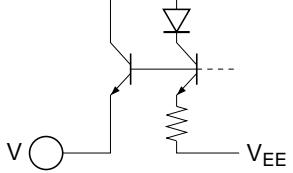
Pin No.	Terminal Name	Note	Equivalent Circuit	Pin Description
51	AIN (R)	$V = \text{GND}$		PB A Deck input
48	AIN (L)			
53	BIN (R)	$V = \text{GND}$		PB B Deck input
46	BIN (L)			
56	RIN (R)	$V = \text{GND}$		REC input
43	RIN (L)			
5	EQIN (R)	$V = \text{GND}$		REC equalizer input
38	EQIN (L)			
1	DET (R)	$V = V_{EE} + 2.7\text{V}$		Time constant pin for Dolby-NR
42	DET (L)			
2	BIAS1	$V = V_{EE} + 0.6\text{V}$		Dolby bias current input
41	BIAS2	$V = V_{EE} + 1.3\text{V}$		REC equalizer bias current input

# HA12215F

**Pin Description, Equivalent Circuit** ( $V_{CC} = \pm 7\text{ V}$ , A system of split supply voltage,  $T_a = 25^\circ\text{C}$ , No Signal, The value in the show typical value.) (cont)

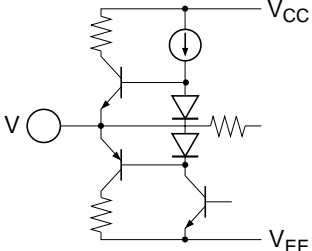
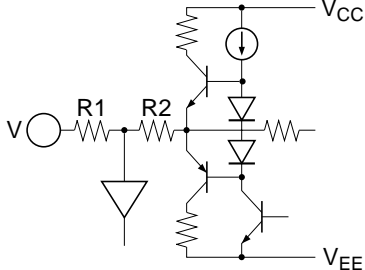
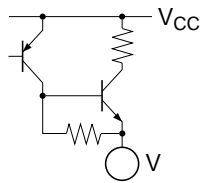
Pin No.	Terminal Name	Note	Equivalent Circuit	Pin Description
3	PBOUT (R)	$V = \text{GND}$		PB output
40	PBOUT (L)			
4	RECOUT (R)	$V = \text{GND}$		REC output
39	RECOUT (L)			
7	EQOUT (R)	$V = \text{GND}$		REC equalizer output
36	EQOUT (L)			
28	MAOUT	$V = \text{GND}$		MS Amp. output *1
8	ROUT (R)	$V = \text{GND}$		Input Amp. output
35	ROUT (L)			
52	ABO (R)	$R1 = 15\text{ k}$ $R2 = 12\text{ k}$		Time constant pin for PB equalizer ( $70\mu$ )
47	ABO (L)			
6	BOOST (R)	$R1 = 4.8\text{ k}$ $R2 = 4.8\text{ k}$		Time constant pin for low boost
37	BOOST (L)			
31	BIAS (M)	$V = V_{CC} - 0.7\text{V}$		REC bias current output
32	BIAS (C)			
33	BIAS (N)			

Note: 1. MS: Music Sensor

**Pin Description, Equivalent Circuit** ( $V_{CC} = \pm 7\text{ V}$ , A system of split supply voltage,  $T_a = 25^\circ\text{C}$ , No Signal, The value in the show typical value.) (cont)

Pin No.	Terminal Name	Note	Equivalent Circuit	Pin Description
21	$V_{CC}$	$V = V_{CC}$		Power supply
49	GND	$V = 0\text{V}$		GND pin
50	$V_{EE}$	$V = V_{EE}$		Negative power supply
45, 54	NC	No connection		No connection
15	ALC $\overline{\text{ON/OFF}}$	$I = 50\ \mu\text{A}$		Mode control input
16	PB $\overline{\text{A/B}}$			
17	A $\overline{120/70}$			
18	$\overline{\text{NORM/HIGH}}$			
19	B $\overline{\text{NORM/CROM/METAL}}$			
20	BIAS $\overline{\text{ON/OFF}}$			
22	RM $\overline{\text{ON/OFF}}$			
23	NR $\overline{\text{ON/OFF}}$			
25	LM $\overline{\text{ON/OFF}}$			
24	$\overline{\text{REC/PB/PASS}}$			Mode control input
26	MSOUT	$I = 0\ \mu\text{A}$		MS output (to MPU) *1

Note: 1. MS: Music Sensor

# HA12215F

**Pin Description, Equivalent Circuit** ( $V_{CC} = \pm 7\text{ V}$ , A system of split supply voltage,  $T_a = 25^\circ\text{C}$ , No Signal, The value in the show typical value.) (cont)

Pin No.	Terminal Name	Note	Equivalent Circuit	Pin Description
10	GPCAL	$R = 110\text{ k}\Omega$		GP gain calibration terminal
11	RECCAL	$R = 110\text{ k}\Omega$		REC gain calibration terminal
12	ALCCAL	$R = 140\text{ k}\Omega$		ALC operation level calibration terminal
14	MSDET	$n = 6$		Time constant pin for MS *1
13	ALCDET	$n = 2$		
27	MSIN	$R = 50\text{ k}\Omega$		MS input *1
9	ALCIN (R)	$R = 100\text{ k}\Omega$		
34	ALCIN (L)			
30	MAI	$V = \text{GND}$		MS Amp. input *1
29	MS GND	$I = \pm 100\text{ }\mu\text{A}$		MS output voltage level control pin *1
55	ALC (R)	$V = \text{GND}$		Variable impedance for attenuation
44	ALC (L)			

Note: 1. MS: Music Sensor

Block Diagram

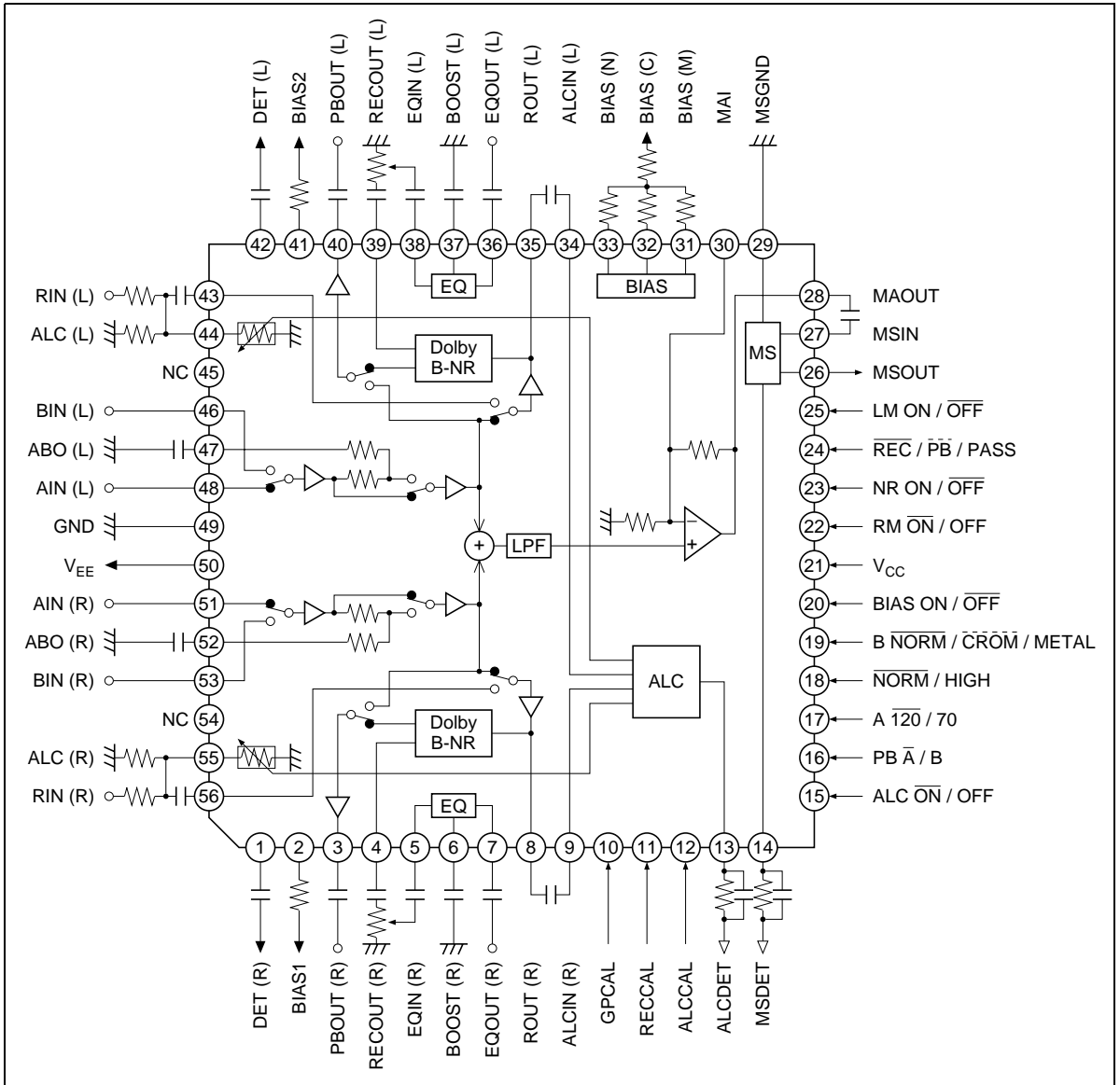

# HA12215F

## Parallel-Data Format

Pin No.	Pin Name	Lo	Mid	Hi	MODE "Pin Open"
15	ALC $\overline{\text{ON}}$ /OFF	ALC ON	—	ALC OFF	Lo
16	PB $\overline{\text{A}}$ /B	Ain * <sup>1</sup>	—	Bin * <sup>1</sup>	Lo
17	A $\overline{\text{120/70}}$	*1	—	*1	Lo
22	RM $\overline{\text{ON}}$ /OFF	REC MUTE ON	—	REC MUTE OFF	Lo
20	BIAS ON/ $\overline{\text{OFF}}$	BIAS OFF	—	BIAS ON	Lo
23	NR ON/ $\overline{\text{OFF}}$	NR OFF	—	NR ON	Lo
24	$\overline{\text{REC}}$ /PB/PASS	REC MODE	PB MODE	REC MODE PASS	Mid
25	LM ON/ $\overline{\text{OFF}}$	LINE MUTE OFF	—	LINE MUTE ON	Lo
18	$\overline{\text{NORM}}$ /HIGH	Normal speed	—	High speed	Lo
19	B $\overline{\text{NORM}}$ /CROM/ METAL	REC EQ Normal * <sup>1</sup> Bias Normal	REC EQ CROM * <sup>1</sup> Bias CROM	REC EQ METAL * <sup>1</sup> Bias METAL	Lo

Note: 1. PB EQ logic

## PB EQ Logic

A $\overline{\text{120/70}}$	B $\overline{\text{NORM}}$ / CROM / METAL	PB	
		Lo	Hi
Lo	Lo	FLAT	FLAT
Lo	Hi or Mid	FLAT	70 $\mu$
Hi	Lo	70 $\mu$	FLAT
Hi	Hi or Mid	70 $\mu$	70 $\mu$



## Functional Description

### Power Supply Range

HA12215F is designed to operate on split supply.

**Table 1 Supply Voltage**

Product	V <sub>CC</sub> (V)	V <sub>EE</sub> (V)	Note
HA12215F	+6.0 to +7.5	-7.5 to -6.0	V <sub>CC</sub> + V <sub>EE</sub>   < 1.0 V

Note: The lower limit of supply voltage depends on the line output reference level.  
The minimum value of the overload margin is specified as 12 dB by Dolby Laboratories.

### Reference Voltage

The reference voltage are provided for the left channel and the right channel separately. The block diagram is shown as figure 1.

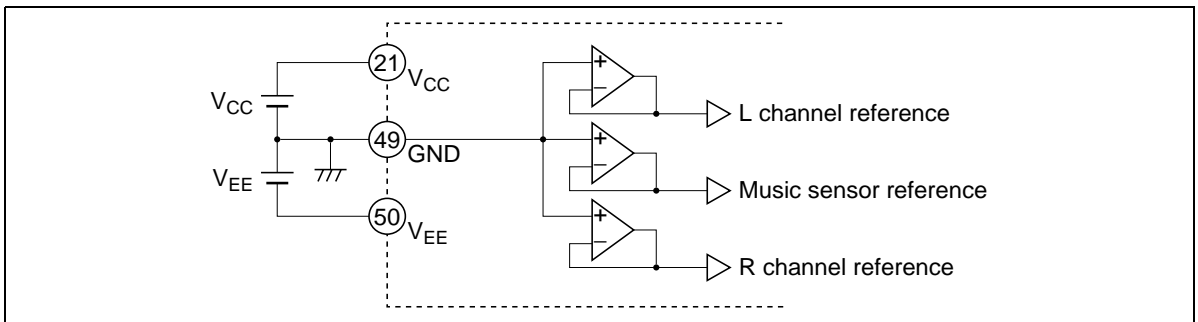

**Figure 1 Reference Voltage**

# HA12215F

## Operating Mode Control

HA12215F provide fully electronic switching circuits. And each operating mode control is controlled by parallel data (DC voltage).

**Table 2 Control Voltage**

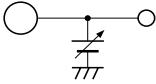
Pin No.	Lo	Mid	Hi	Unit	Test Condition
15, 16, 17, 18, 20, 22, 23, 25	-0.2 to 1.0	—	4.0 to $V_{CC}$	V	Input Pin Measure 
19, 24	-0.2 to 1.0	2.0 to 3.0	4.0 to $V_{CC}$	V	

- Notes:
- Each pins are on pulled down with 100 k $\Omega$  internal resistor. Therefore, it will be low-level when each pins are open. But pin 24 is mid-level when it is open.
  - Over shoot level and under shoot level of input signal must be the standardized (High:  $V_{CC}$ , Low: -0.2 V).
  - For reduction of pop noise, connect 1  $\mu$ F to 22  $\mu$ F capacitor with mode control pins. But it is impossible to reduce completely in regard to Line mute, therefore, use external mute at the same time.

## Input Block Diagram and Level Diagram

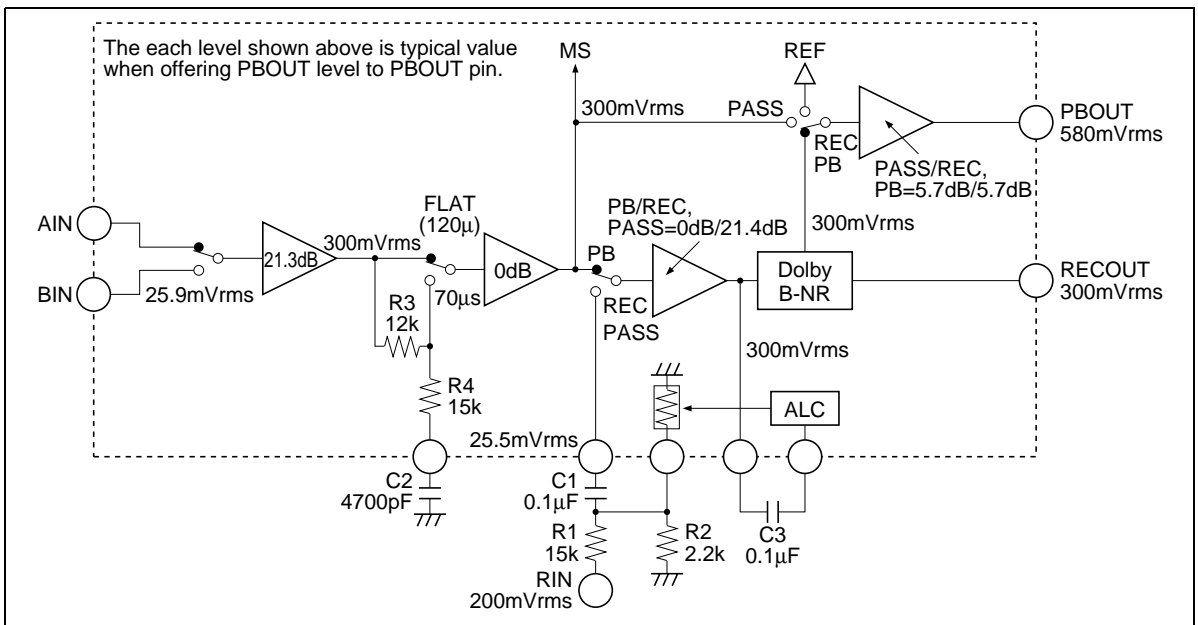
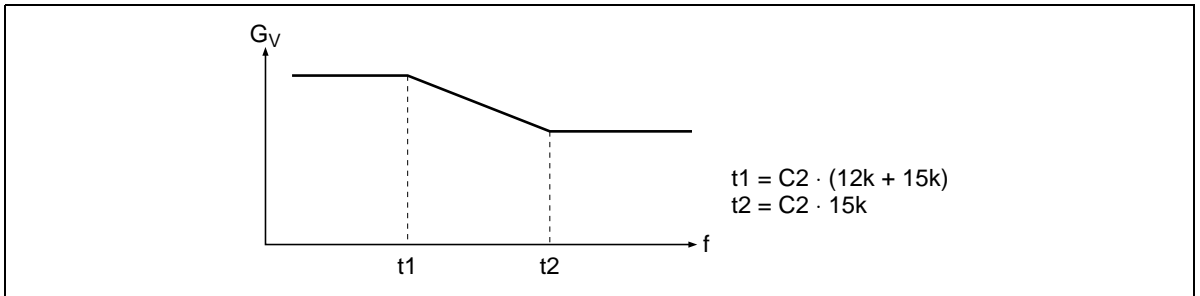

**Figure 2 Input Block Diagram**

**PB Equalizer**

By switching logical input level of pin 17 (for Ain) and pin 19 (for Bin), you can equalize corresponding to tape position at play back mode.

With the capacity C2 capacitance that we showed for figure 2 70 μs by the way figure seem to 3 they are decided.



**Figure 3 Frequency Characteristic of PB Equalizer**

**The Sensitivity Adjustment of Music Sensor**

Adjusting MS Amp gain by external resistor, the sensitivity of music sensor can set up.

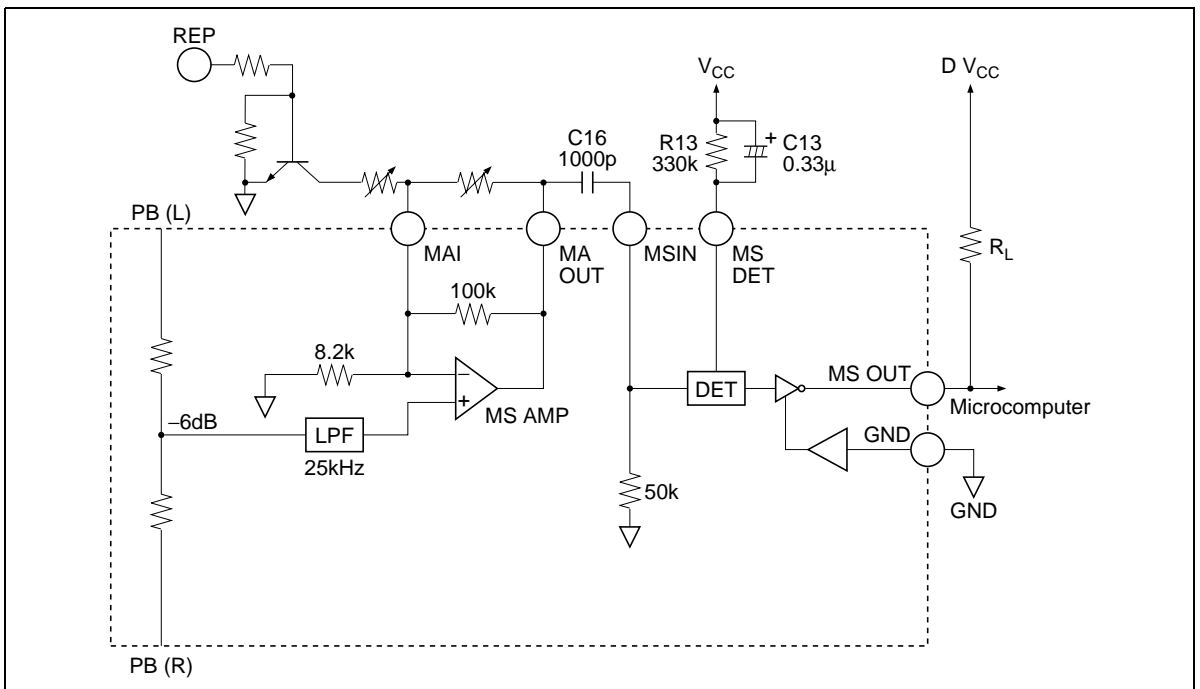

**Figure 4 Music Sensor Block Diagram**

## The Sensitivity of Music Sensor

A standard level of MS input pin 25.9 mVrms, therefore, the sensitivity of music sensor (S) can request it, by lower formulas.

$$\begin{aligned}
 A &= \text{MS Amp Gain} \times 1 \\
 B &= \text{PB input Gain} \times (1/2)^2 & S &= 20 \log \frac{C}{25.9 \cdot A \cdot B} \text{ [dB]} \\
 C &= \text{Sensed voltage} \\
 20 \log (A \times B) &= D \text{ [dB]} & S &= 14 - D \text{ [dB]} \\
 C &= 130 \text{ [mVrms]} \text{ (Intenally voltage in a standard)} \\
 \text{PB input Gain} &= 21.3 \text{ [dB]}
 \end{aligned}$$

Notes: 1. When there is not a regulation outside.

2. Case of one-sided channel input.

But necessary to consider the same attenuation quantity practically, on account of A(B) have made frequency response.

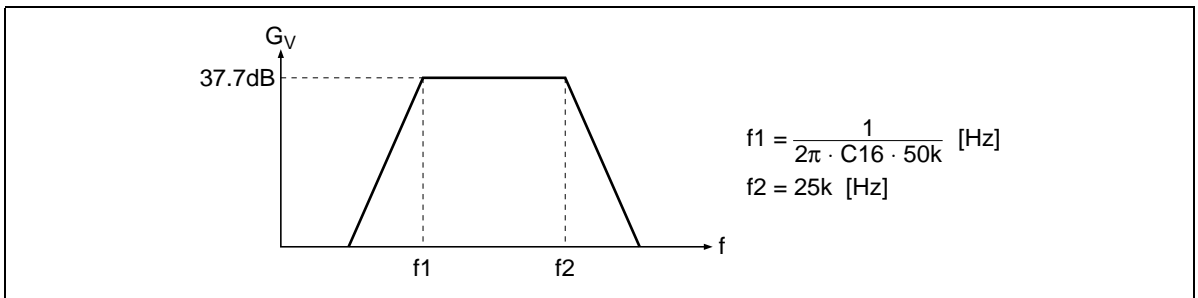

**Figure 5 Frequency Characteristic of MSIN**

Occasion of the external component of figure 4, f1 is 3.18 kHz.

## Time constant of detection

Figure 6(1) generally shows that detection time is in proportion to value of capacitor C13. But, with Attack\*<sup>2</sup> and Recovery\*<sup>3</sup> the detection time differs exceptionally.

Notes 2. Attack : Non- music to Music

3. Recovery : Music to Non-music

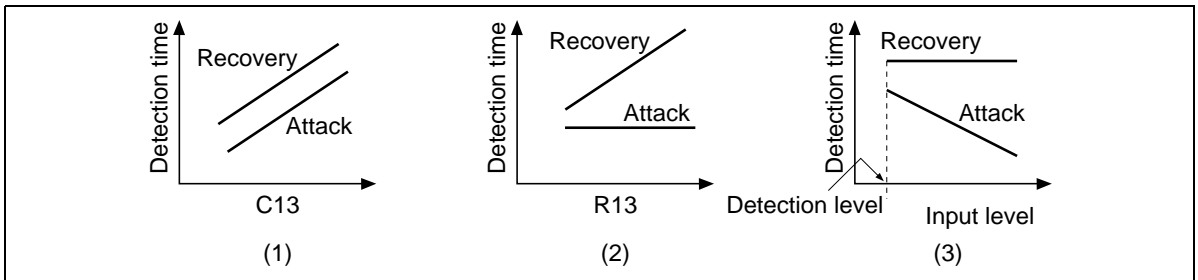

**Figure 6 Function Characteristic of MS**

Like the figure 6(2), Recovery time is variably possible by value of resistor R13. But Attack time gets about fixed value. Attack time has dependence by input level. When a large signal is inputted, Attack time is short tendency.

**Music Sensor Output (MSOUT)**

As for internal circuit of music sensor block, music sensor output pin is connected to the collector of NPN type directly, output level will be “high” when sensing no signal. And output level will be “low” when sensing signal.

Connection with microcomputer, it is requested to use external pull up resistor ( $R_L = 10\text{ k}\Omega$  to  $22\text{ k}\Omega$ )

Note: Supply voltage of MSOUT pin must be less than  $V_{CC}$  voltage.

**The Tolerances of External Components**

For Dolby NR precision securing, please use external components shown at figure 7. If leak-current are a few electrolytic-capacitor, it can be applicable to C5 and C23.

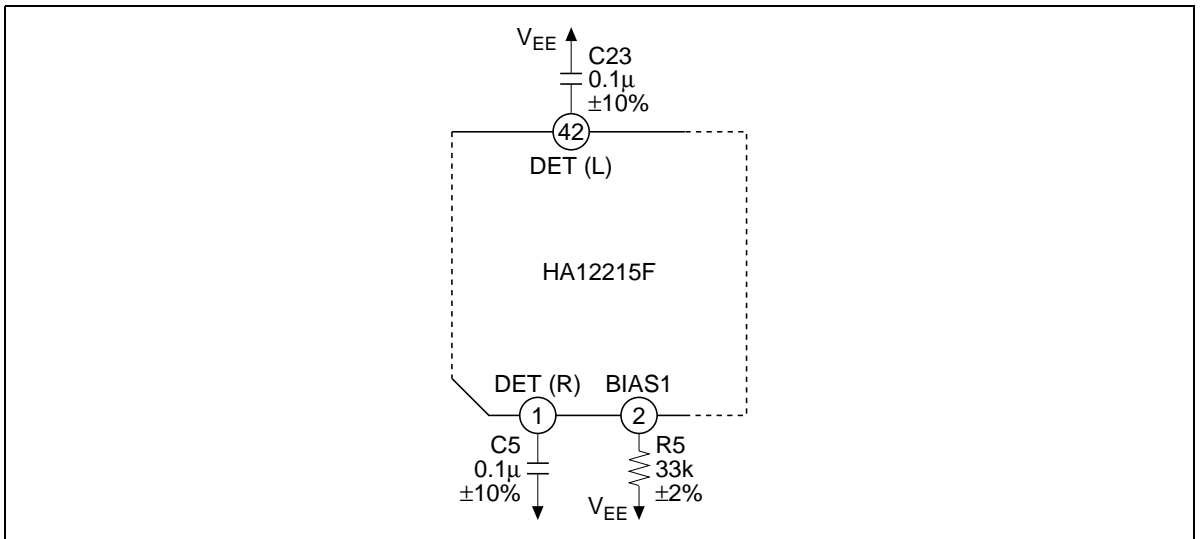

**Figure 7 Tolerance of External Components**

**Low-Boost**

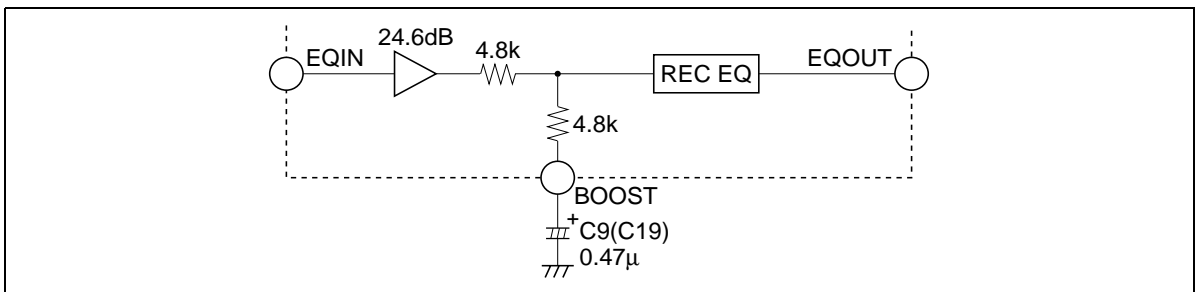

**Figure 8 Example of Low Boost Circuit**

External components shown figure 8 gives frequency response to take 6 dB boost. And cut off frequency can request it, by C9 (C19).

# HA12215F

## REC Equalizer

The outlines of REC Equalizing frequency characteristics are shown by figure 9. Those peak level can be set up by supplying voltage. (0 V to 5 V, GND = 0 V) to pin 10 (GPCAL).

And whole band gain can be set up by supplying voltage (0 V to 5 V, GND = 0 V) to pin 11 (RECCAL).

Both setting up range are  $\pm 4.5$  dB. In case that you do not need setting up, pin 10, pin 11 should be open bias.

Note: Depending on the employed REC/PB head and test tape characteristics, there is a rare case that the REC-EQ characteristics of this LSI can not be matched to the required characteristics because of built-in resistors which determined the REC-EQ parameters in this case, please inquire the responsible agent because of the adjustment of built-in resistor is necessary.

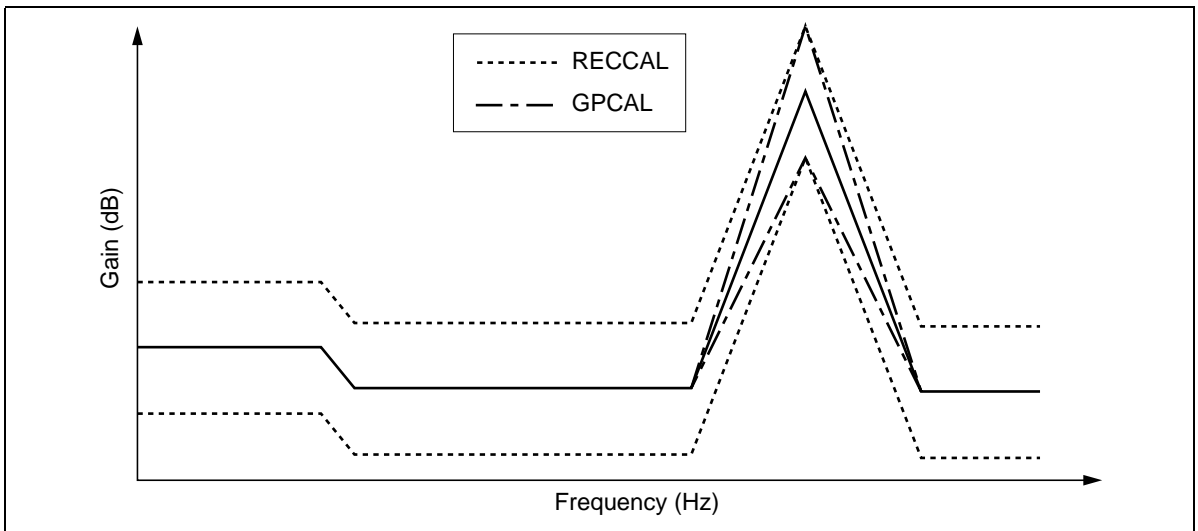

**Figure 9 Frequency Characteristics of REC Equalizer**

## Bias Switch

HA12215F built-in DC voltage generator for bias oscillator and its bias switches.

External resistor R19, R20, R21 which corresponded with tape positions and bias out voltage are related with below.

$$V_{\text{bias}} \cong \left( \frac{R22}{(R19 \text{ or } R20 \text{ or } R21) + R22} \right) \times (V_{\text{CC}} - V_{\text{EE}} - 0.7) + V_{\text{EE}} \quad [\text{V}]$$

Bias switch follows to a logic of pin 19 (B / Norm / Crom / Metal).

Note: A current that flows at bias out pin, please use it less than 5 mA.

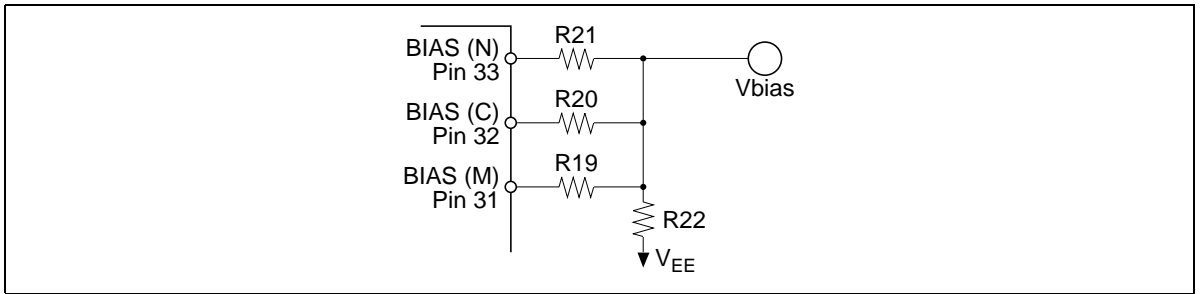

**Figure 10 External Components of Bias Block**

**Automatic Level Control**

ALC is the input decay rate variable system. It has internal variable resistors of pin 55 (pin 44) by RECOUT signal that is inputted to pin 9 (pin 34).

The operation is similitude to MS, detected by pin 13.

The signal input pin is pin 56 (pin 43). Resistor R1, R2 and capacitor C2, external components, for the input circuit are commended as figure 12. There are requested to use value of the block diagram figure for performance maintenance of S/N, T.H.D. etc.

Figure 11 shows the relation with R1 front RIN point and ROUT.

ALC operation level acts for the center of +4.5 dB at tape position TYPE I, IV and the center of +2.5 dB at tape position TYPE II, to standard level (300 mVrms).

Then, adopted maximum value circuit, ALC is operated by a large channel of a signal.

ALC ON/OFF can switch it by pin 15. Please do ALC ON, after it does for one time ALC OFF inevitably, for ALC time to start usefully (when switching PB → PASS, when switching PB → PASS), in order to reset ALC circuit.

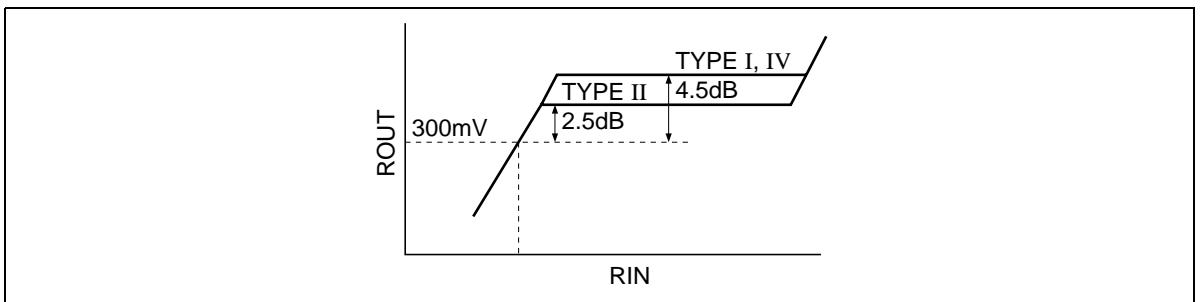

**Figure 11 ALC Operation Level**

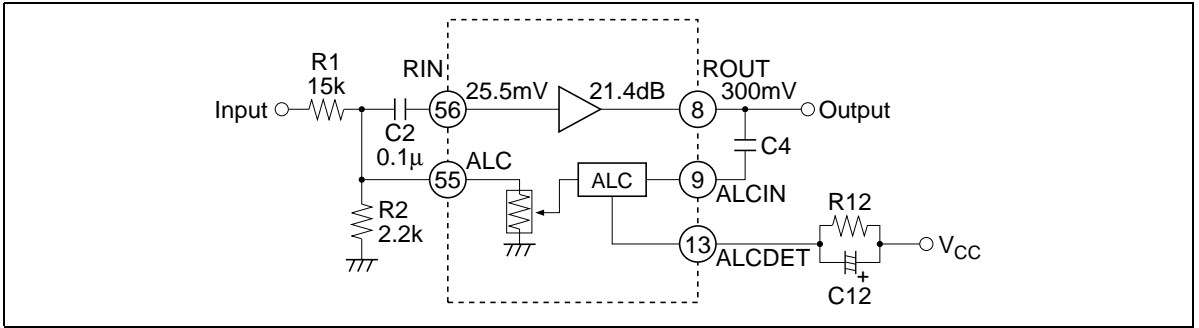
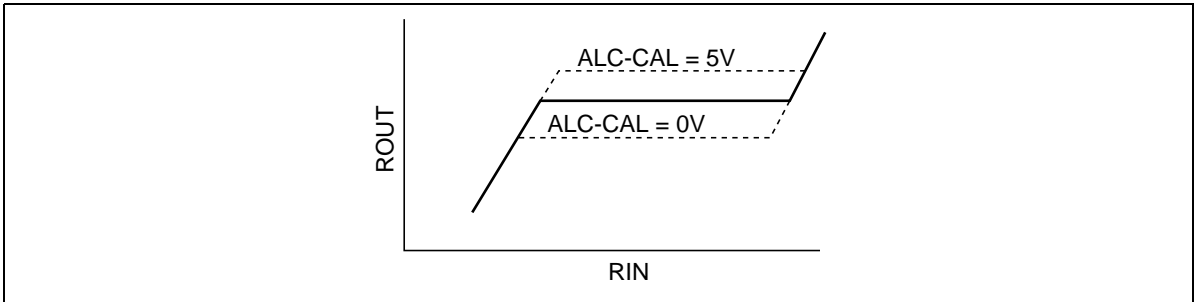

**Figure 12 ALC Block Diagram**

**ALC Operation Level Necessary**

ALC operation level is variable to pin 12 bias (ALC-CAL: 0 to 5 V), and its range is  $\pm 4.0$  dB.

Unnecessary, pin 12 is unforced.



**Figure 13 ALC-CAL Characteristics**



**Absolute Maximum Ratings**

<b>Item</b>	<b>Symbol</b>	<b>Rating</b>	<b>Unit</b>	<b>Note</b>
Max supply voltage	$V_{cc}$ max	16	V	
Power dissipation	Pd	625	mW	$T_a \leq 75^\circ\text{C}$
Operating temperature	Topr	-40 to +75	°C	
Storage temperature	Tstg	-55 to +125	°C	

## Electrical Characteristics

(Ta = 25°C, V<sub>CC</sub> = ±7 V, Dolby Level = REC-OUT Level = 300 mVrms = 0 dB)

Item	Symbol	Test Condition										Application Terminal									
		IC Condition *1					Other					Input		Output		COM Remark					
		NR ON/OFF	REC/PB /PASS	A/B	120µ/70µ	MUTE	LINE N/C/M	B N/C/M	fin (Hz)	RECOU level (dB)	No signal	Min	Typ	Max	Unit		R	L	R	L	
Quiescent current	I <sub>Q</sub>	OFF	PB	A	120	OFF	NORM	1k	0	—	—	—	35.0	mA	—	—	—	—	—		
Input AMP. gain	G <sub>V</sub> PB	OFF	PB	A/B	120	OFF	NORM	1k	0	—	—	—	25.5	27.0	28.5	dB	51/53	48/46	3	40	—
	G <sub>V</sub> REC	OFF	REC	A	120	OFF	NORM	1k	0	—	—	—	25.0	26.5	28.0	dB	56	43	3	40	—
	B-type Encode boost	ENC 2k (1)	ON	REC	A	120	OFF	NORM	2k	-20	—	—	2.8	4.3	5.8	dB	56	43	4	39	—
	ENC 2k (2)	ON	REC	A	120	OFF	NORM	2k	-30	—	—	7.0	8.5	10.0	dB	56	43	4	39	—	
	ENC 5k (1)	ON	REC	A	120	OFF	NORM	5k	-20	—	—	1.7	3.2	4.7	dB	56	43	4	39	—	
	ENC 5k (2)	ON	REC	A	120	OFF	NORM	5k	-30	—	—	6.7	8.2	9.7	dB	56	43	4	39	—	
Signal handling	V <sub>o</sub> max	ON	REC	A	120	OFF	NORM	1k	—	—	—	12.0	13.0	—	dB	56	43	4	39	—	
Signal to noise ratio	S/N	ON	REC	A	120	OFF	NORM	1k	—	—	—	64.0	70.0	—	dB	56	43	4	39	—	
Total Harmonic Distortion	THD	ON	REC	A	120	OFF	NORM	1k	0	—	—	—	0.05	0.3	%	56	43	4	39	—	
Channel separation	CTRL (1)	OFF	PB	A/B	120	OFF	NORM	1k	+12	—	—	70.0	80.0	—	dB	51/53	48/46	3	40	—	
	CTRL (2)	OFF	REC	A	120	OFF	NORM	1k	+12	—	—	70.0	85.0	—	dB	56	43	3	40	—	
Crosstalk	CT A/B	OFF	PB	A/B	120	OFF	NORM	1k	+12	—	—	70.0	80.0	—	dB	51/53	48/46	3	40	—	
	CT R/P	OFF	REC/PB	A	120	OFF	NORM	1k	+12	—	—	70.0	80.0	—	dB	51/56	48/43	3	40	—	
Pass AMP. gain	G <sub>V</sub> PA	OFF	PASS	A/B	120	OFF	NORM	1k	0	—	—	25.5	27.0	28.5	dB	51/53	48/46	3	40	—	
Gain deviation	ΔG <sub>V</sub>	OFF	PASS	A/B	120	OFF	NORM	1k	0	—	—	-1.0	0.0	1.0	dB	51/53	48/46	3	40	—	
MUTE ATT.	MUTE	OFF	PB	A	120	ON	NORM	1k	+12	—	—	70.0	80.0	—	dB	51	48	3	40	—	
70µ EQ gain	G <sub>V</sub> EQ 1k	OFF	PB	A/B	70	OFF	NORM	1k	0	—	—	24.0	25.5	27.0	dB	51/53	48/46	3	40	—	
	G <sub>V</sub> EQ 10k	OFF	PB	A/B	70	OFF	NORM/CROM	10k	0	—	—	20.8	22.3	23.8	dB	51/53	48/46	3	40	—	
MS sensing level	V <sub>ON</sub>	OFF	PB	A	120	OFF	NORM	5k	—	—	—	-26.0	-22.0	-18.0	dB	51	48	—	—	3	
MS output low level	V <sub>OL</sub>	OFF	PB	A	120	OFF	NORM	—	—	—	—	—	1.0	1.5	V	51	48	—	—	—	
MS output leak current	I <sub>OH</sub>	OFF	PB	A	120	OFF	NORM	—	—	—	—	—	—	2.0	µA	—	—	—	—	—	
ALC operate level	ALC (1)	OFF	REC	A	120	OFF	NORM	1k	+12	—	—	2.0	4.5	7.0	dB	56	43	4	39	—	
	ALC (2)	OFF	REC	A	120	OFF	CROM	1k	+12	—	—	0.0	2.5	5.0	dB	56	43	4	39	—	

Notes: 1. Other IC-condition : REC-MUTE OFF, Normal tape, Normal speed, Bias OFF

2. V<sub>CC</sub> = ±6.0 V

3. For inputting signal to one side channel

Electrical Characteristics (cont)

(Ta = 25°C, Vcc = ±7 V)

Item	Symbol	TAPE SPEED		Test Condition										Application Terminal			Remark
		S/N (EQ)	NORM	NORM	f = 5.1kHz, A-WTG Filter (0dB = -5dBs at EQOUT) Vin = -26dBs = 0dB	SW22 (L), SW23 (R) OFF	Min	Typ	Max	Unit	Input			Output			
											R	L	R	L	R	L	
Equalizer S/N	S/N (EQ)	NORM	NORM	NORM	Rg = 5.1kHz, A-WTG Filter (0dB = -5dBs at EQOUT) Vin = -26dBs = 0dB	SW22 (L), SW23 (R) OFF	55	58	—	dB	5	38	7	36	—	—	—
Equalizer maximum input	Vin max (EQ)	NORM	NORM	NORM	f = 1kHz, Vin = -26dBs	SW22 (L), SW23 (R) OFF	10.5	12.5	—	dB	5	38	7	36	—	—	—
Equalizer total harmonic distortion	T.H.D.1 (EQ) T.H.D.2 (EQ)	NORM	NORM	NORM	f = 1kHz, Vin = -26dBs	SW22 (L), SW23 (R) OFF	—	0.2	0.5	%	5	38	7	36	—	—	—
Equalizer offset voltage	Vofs (EQ)	NORM	NORM	NORM	No-Signal	SW22 (L), SW23 (R) OFF	-500	0	500	mV	5	38	7	36	—	—	—
Equalizer frequency response (NORM - NORM)	GVEQ-NN1	NORM	NORM	NORM	f = 3kHz, Vin = -46dBs	SW22 (L), SW23 (R) OFF	18.8	20.3	21.8	dB	5	38	7	36	—	—	—
	GVEQ-NN2	NORM	NORM	NORM	f = 8kHz, Vin = -46dBs	SW22 (L), SW23 (R) OFF	23.9	25.9	27.9	dB	5	38	7	36	—	—	—
	GVEQ-NN3	NORM	NORM	NORM	f = 12kHz, Vin = -46dBs	SW22 (L), SW23 (R) OFF	30.1	32.6	35.1	dB	5	38	7	36	—	—	—
	GVEQ-CN1	CROM	NORM	NORM	f = 3kHz, Vin = -46dBs	SW22 (L), SW23 (R) OFF	23.3	24.8	26.3	dB	5	38	7	36	—	—	—
Equalizer frequency response (CROM - NORM)	GVEQ-CN2	CROM	NORM	NORM	f = 8kHz, Vin = -46dBs	SW22 (L), SW23 (R) OFF	28.5	30.5	32.5	dB	5	38	7	36	—	—	—
	GVEQ-CN3	CROM	NORM	NORM	f = 12kHz, Vin = -46dBs	SW22 (L), SW23 (R) OFF	34.0	36.5	39.0	dB	5	38	7	36	—	—	—
	GVEQ-MN1	METAL	NORM	NORM	f = 3kHz, Vin = -46dBs	SW22 (L), SW23 (R) OFF	24.1	25.6	27.1	dB	5	38	7	36	—	—	—
	GVEQ-MN2	METAL	NORM	NORM	f = 8kHz, Vin = -46dBs	SW22 (L), SW23 (R) OFF	25.9	27.9	29.9	dB	5	38	7	36	—	—	—
Equalizer frequency response (METAL - NORM)	GVEQ-MN3	METAL	NORM	NORM	f = 12kHz, Vin = -46dBs	SW22 (L), SW23 (R) OFF	28.3	30.8	33.3	dB	5	38	7	36	—	—	—
	GVEQ-NH1	NORM	HIGH	HIGH	f = 5kHz, Vin = -46dBs	SW22 (L), SW23 (R) OFF	15.0	16.5	18.0	dB	5	38	7	36	—	—	—
	GVEQ-NH2	NORM	HIGH	HIGH	f = 15kHz, Vin = -46dBs	SW22 (L), SW23 (R) OFF	19.9	21.9	23.9	dB	5	38	7	36	—	—	—
	GVEQ-NH3	NORM	HIGH	HIGH	f = 20kHz, Vin = -46dBs	SW22 (L), SW23 (R) OFF	23.4	25.9	28.4	dB	5	38	7	36	—	—	—
Equalizer frequency Response (CROM - High)	GVEQ-CH1	CROM	HIGH	HIGH	f = 5kHz, Vin = -46dBs	SW22 (L), SW23 (R) OFF	19.9	21.4	22.9	dB	5	38	7	36	—	—	—
	GVEQ-CH2	CROM	HIGH	HIGH	f = 15kHz, Vin = -46dBs	SW22 (L), SW23 (R) OFF	23.7	25.7	27.7	dB	5	38	7	36	—	—	—
	GVEQ-CH3	CROM	HIGH	HIGH	f = 20kHz, Vin = -46dBs	SW22 (L), SW23 (R) OFF	26.9	29.4	31.9	dB	5	38	7	36	—	—	—
	GVEQ-MH1	METAL	HIGH	HIGH	f = 5kHz, Vin = -46dBs	SW22 (L), SW23 (R) OFF	21.4	22.9	24.4	dB	5	38	7	36	—	—	—
Equalizer frequency response (METAL - High)	GVEQ-MH2	METAL	HIGH	HIGH	f = 15kHz, Vin = -46dBs	SW22 (L), SW23 (R) OFF	22.0	24.0	26.0	dB	5	38	7	36	—	—	—
	GVEQ-MH3	METAL	HIGH	HIGH	f = 20kHz, Vin = -46dBs	SW22 (L), SW23 (R) OFF	23.5	26.0	28.5	dB	5	38	7	36	—	—	—
	REC-MUTE attenuation	REC-MUTE	NORM	NORM	f = 1kHz, Vin = -14dBs	SW22 (L), SW23 (R) OFF	60	70	—	dB	5	38	7	36	—	—	—

## Electrical Characteristics (cont)

(T<sub>a</sub> = 25°C, V<sub>CC</sub> = ±7 V)

Item	Symbol	TAPE SPEED		Test Condition		Min	Typ	Max	Unit	Application Terminal							
		NORM	SPEED							Input		Output		COM		Remark	
REC CAL response	R-CAL1	NORM	NORM	f = 3kHz, Vin = -46dBs, V <sub>REC-CAL</sub> = 5V	G <sub>V<sub>EQ-NN1</sub></sub> = 0dB	3.0	4.5	6.0	dB	R	L	R	L	36	7		36
	R-CAL2	NORM	NORM	f = 3kHz, Vin = -46dBs, V <sub>REC-CAL</sub> = 0V	G <sub>V<sub>EQ-NN1</sub></sub> = 0dB	-6.0	-4.5	-3.0	dB	R	L	R	L	36	7	36	—
GP CAL response	GP-CAL1	NORM	NORM	f = 12kHz, Vin = -46dBs, V <sub>GP-CAL</sub> = 0V	G <sub>V<sub>EQ-NN3</sub></sub> = 0dB	3.0	4.5	6.0	dB	R	L	R	L	36	7	36	—
	GP-CAL2	NORM	NORM	f = 12kHz, Vin = -46dBs, V <sub>GP-CAL</sub> = 5V	G <sub>V<sub>EQ-NN3</sub></sub> = 0dB	-6.0	-4.5	-3.0	dB	R	L	R	L	36	7	36	—
ALC CAL response	ALC-CAL1	NORM	NORM	f = 1kHz, V <sub>ALC-CAL</sub> = 0V	ALC (1) = 0dB	—	-4.0	-3.0	dB	R	L	R	L	36	7	36	—
	ALC-CAL2	NORM	NORM	f = 1kHz, V <sub>ALC-CAL</sub> = 5V	ALC (1) = 0dB	—	-4.0	-3.0	dB	R	L	R	L	36	7	36	—
Bias out maximum level	Bias on	R <sub>L</sub> = 2.4kΩ + 270Ω				V <sub>CC</sub> -1.4	V <sub>CC</sub> -0.7	—	V	—	—	—	—	—	—	—	31 to 33
Bias out offset	Bias off	R <sub>L</sub> = 2.4kΩ + 270Ω				V <sub>EE</sub> -0.1	V <sub>EE</sub> +0.1	—	V	—	—	—	—	—	—	—	31 to 33
Control voltage	V <sub>IL</sub>					-0.2	—	1.0	V	—	—	—	—	—	—	—	15 to 20 22 to 25
	V <sub>IM</sub>					2.0	—	3.0	V	—	—	—	—	—	—	—	19, 24
	V <sub>IH</sub>					4.0	—	5.3	V	—	—	—	—	—	—	—	15 to 20 22 to 25

Test Circuit

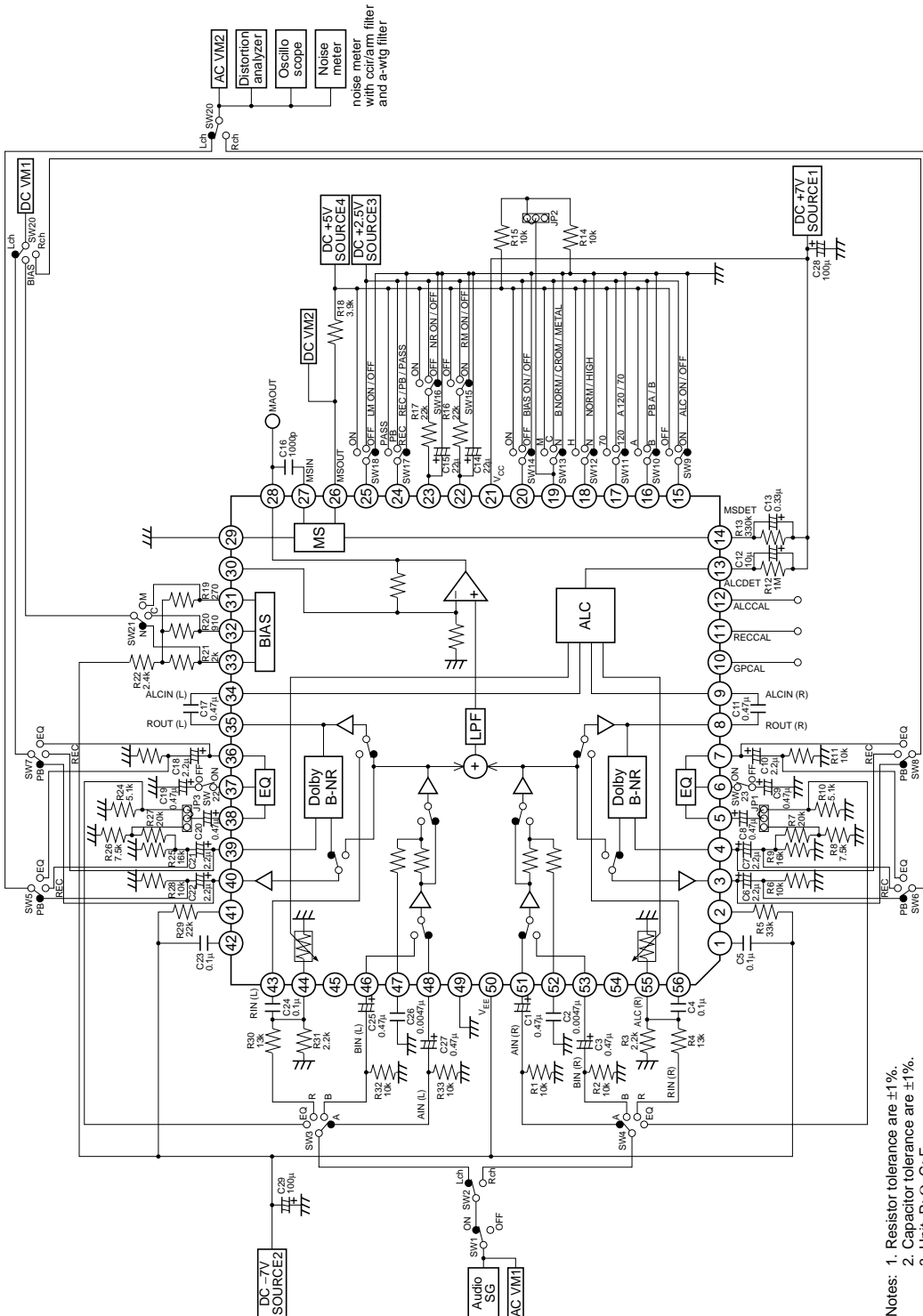

Notes: 1. Resistor tolerance are  $\pm 1\%$ .  
 2. Capacitor tolerance are  $\pm 1\%$ .  
 3. Unit R:  $\Omega$ , C: F.

## Characteristic Curves

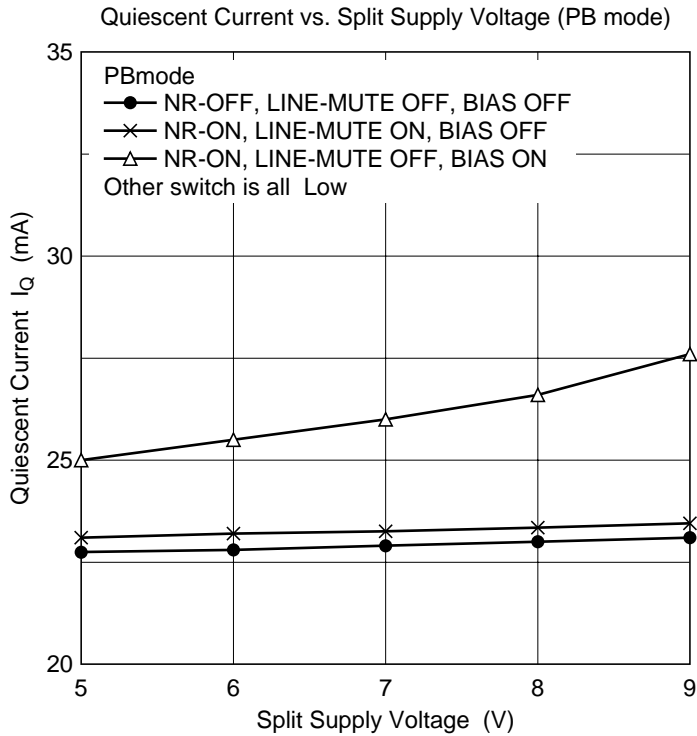
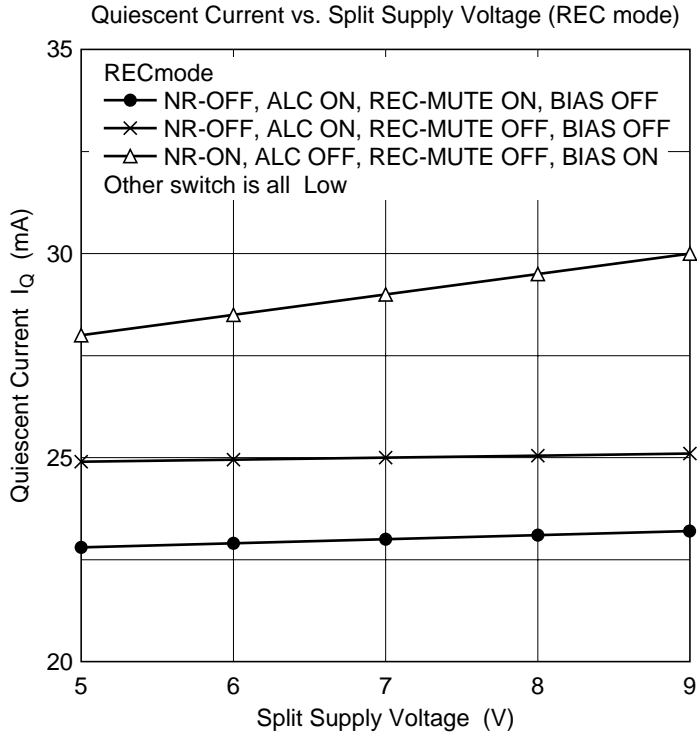

Input Amp. Gain vs. Frequency (1)

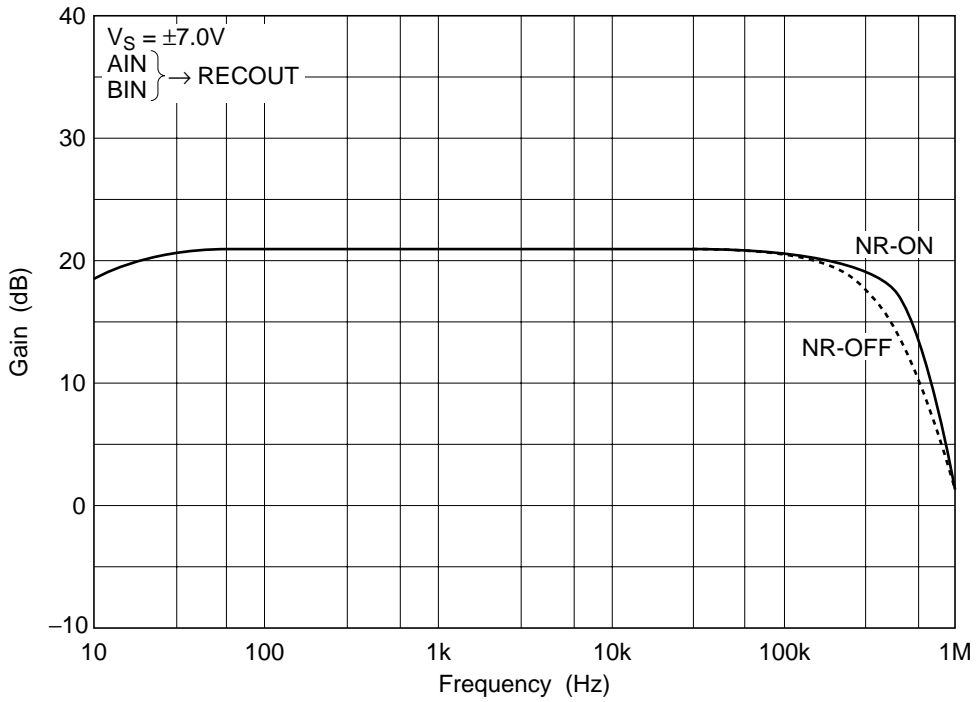

Input Amp. Gain vs. Frequency (2)

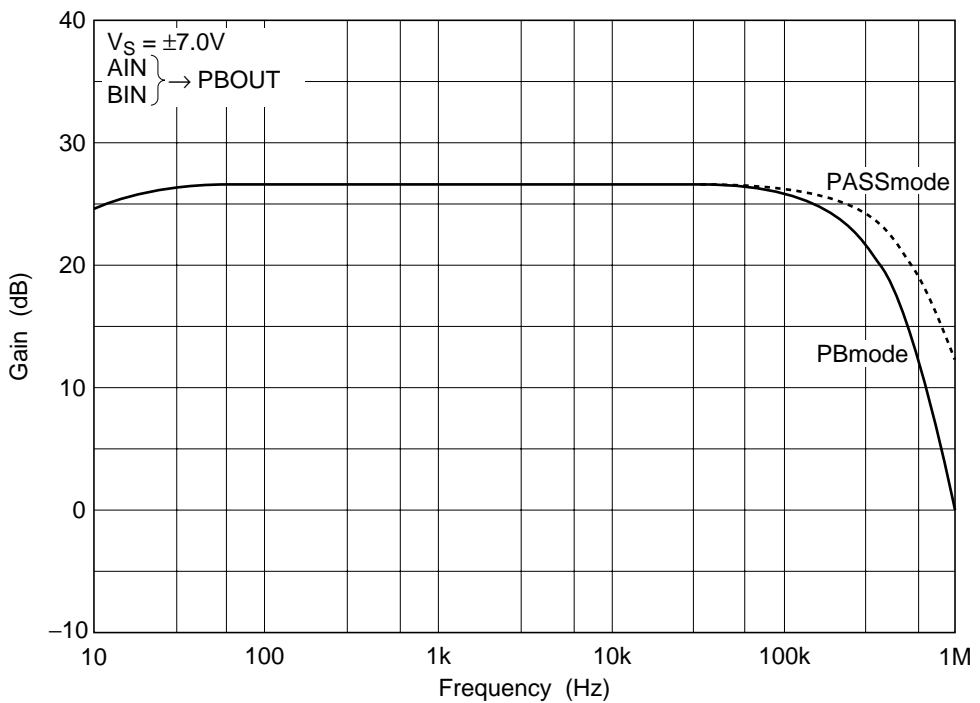

### Input Amp. Gain vs. Frequency (3)

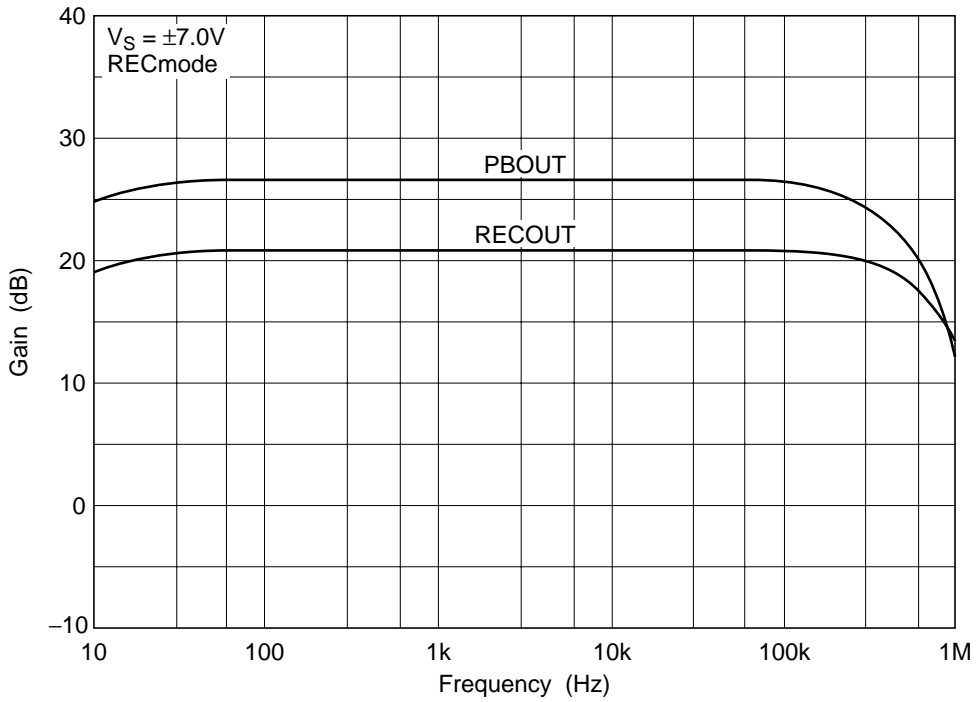

### Input Amp. Gain vs. Frequency (4)

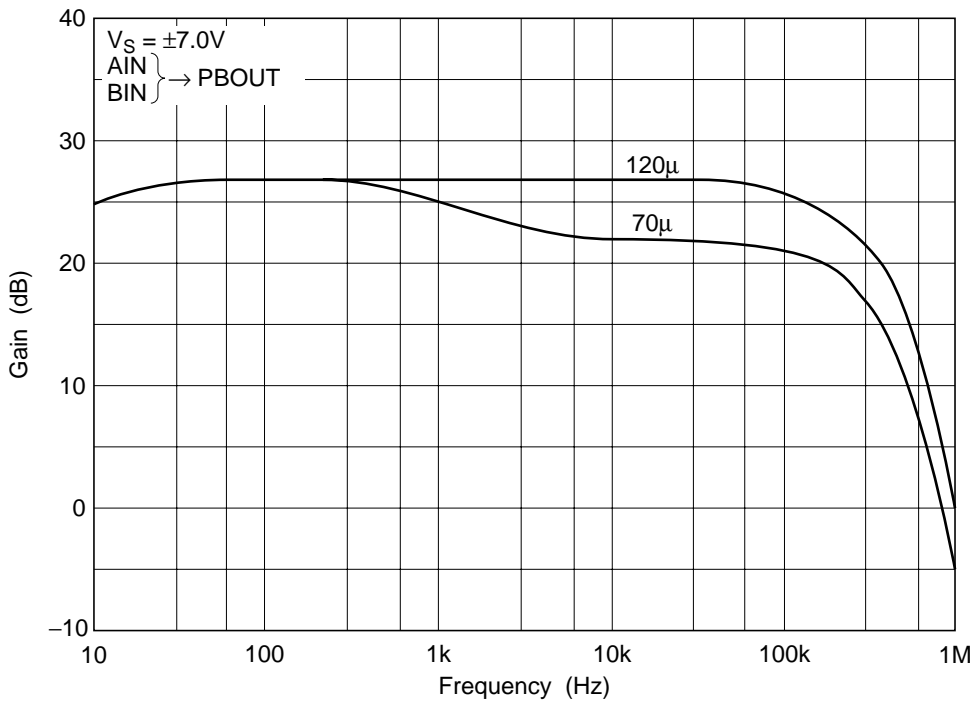



Encode Boost vs. Frequency

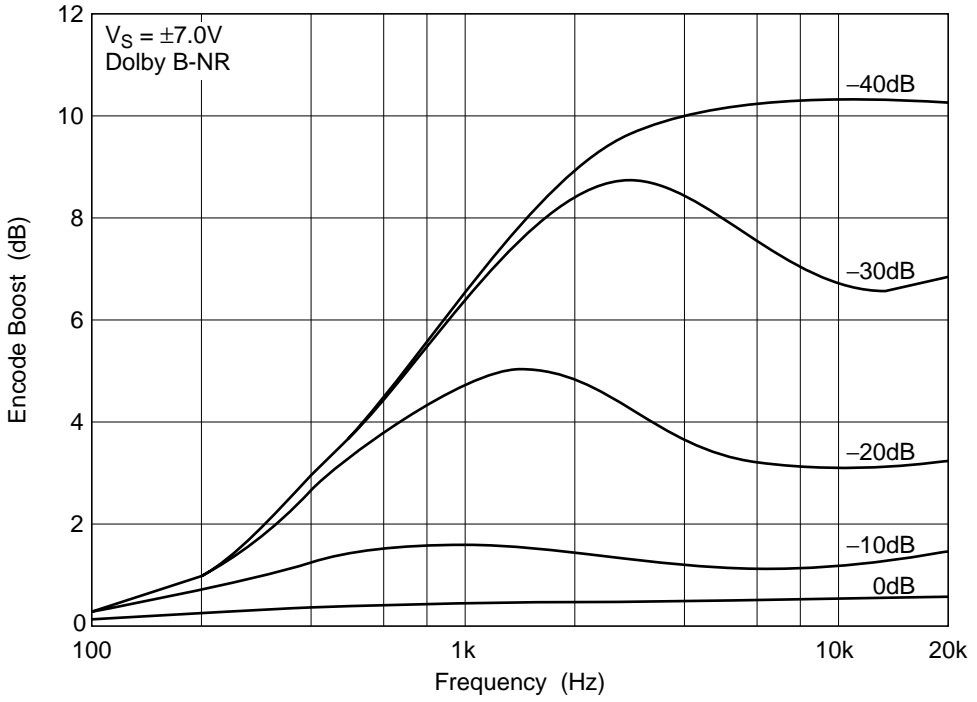

Decode Cut vs. Frequency

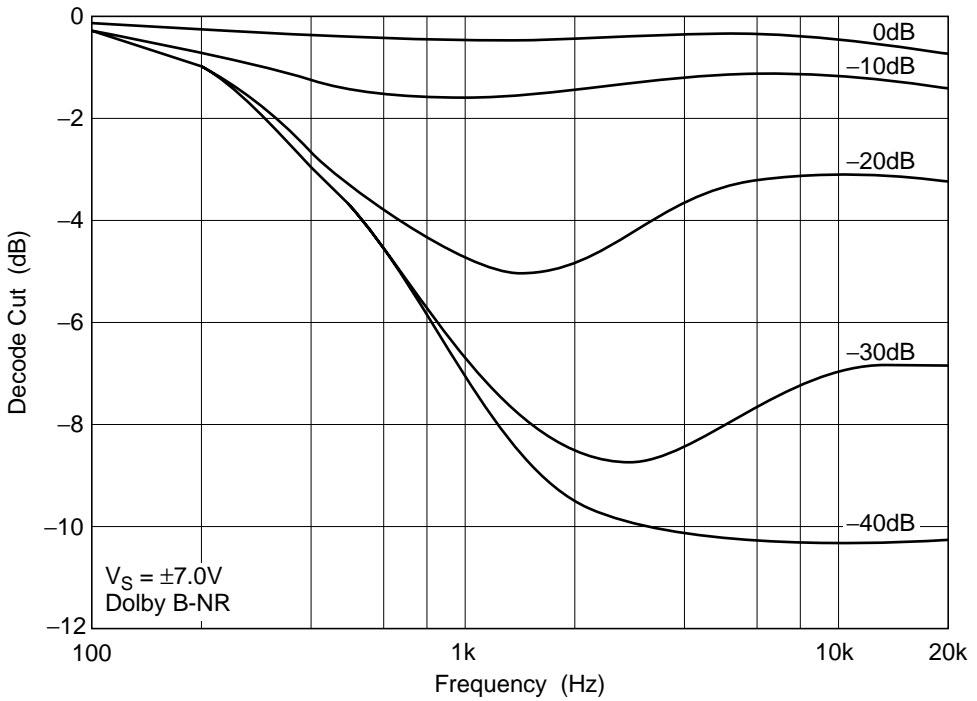

Signal Handling (1)

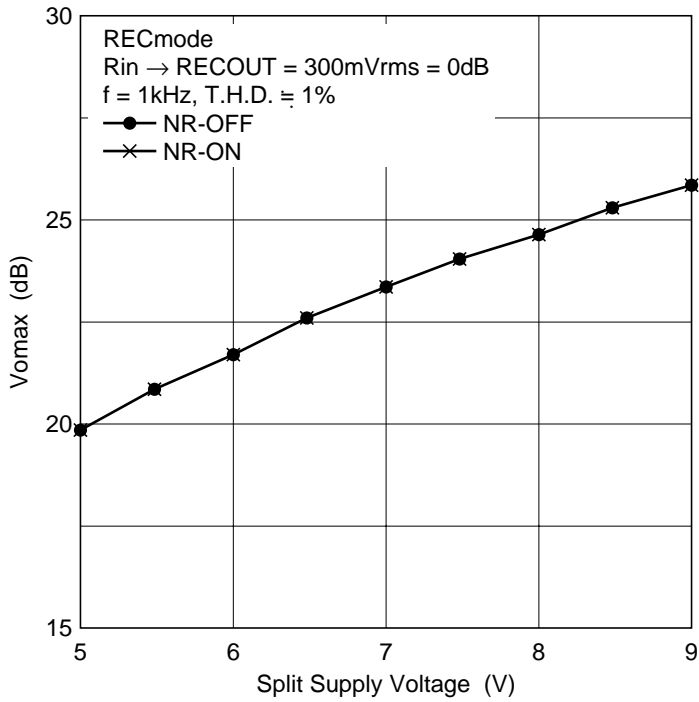

Signal Handling (2)

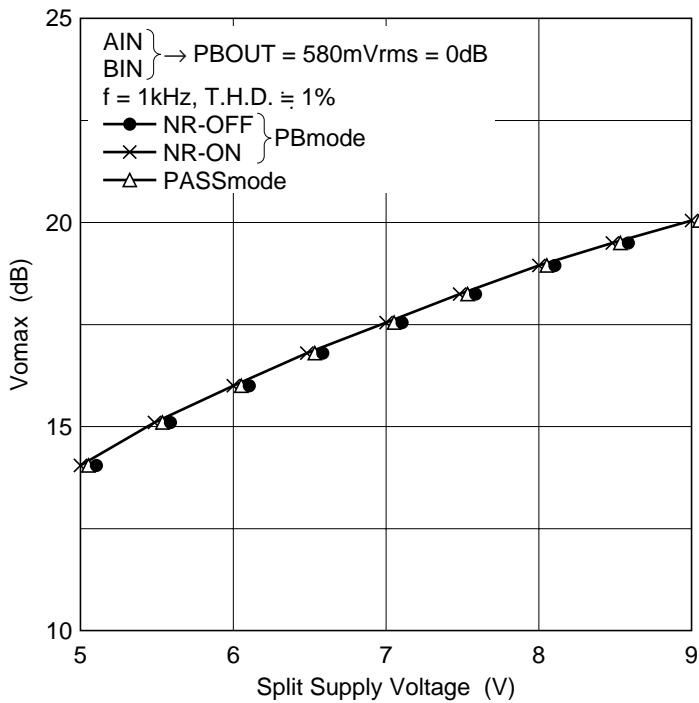

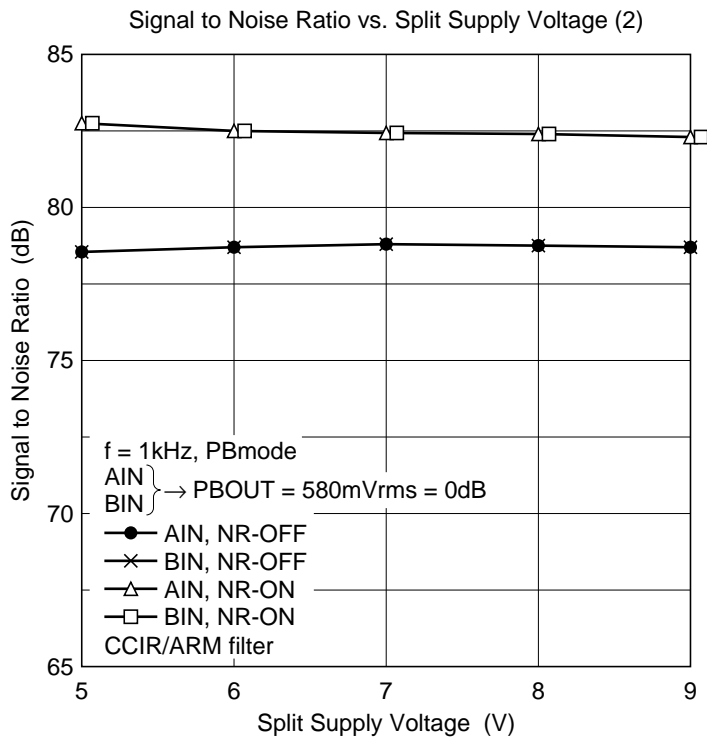
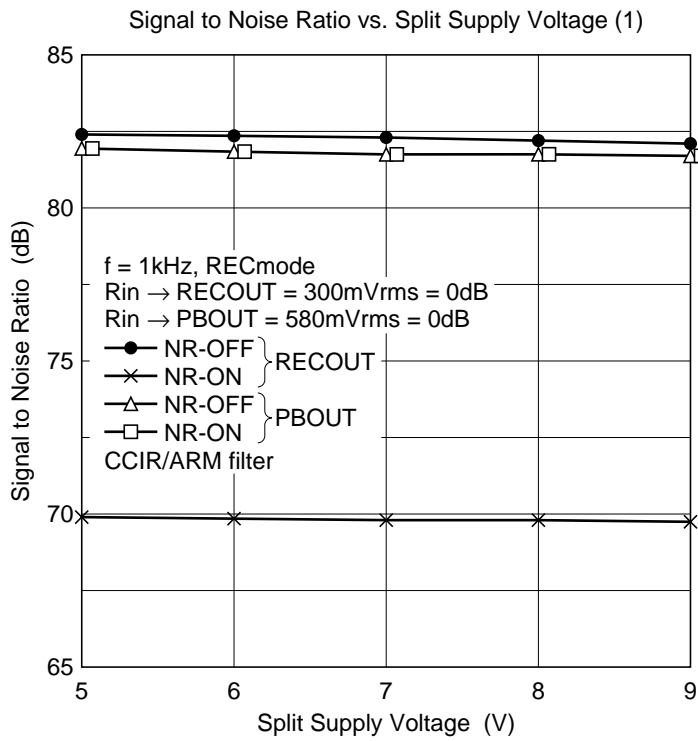

Signal to Noise Ratio vs. Split Supply Voltage (3)

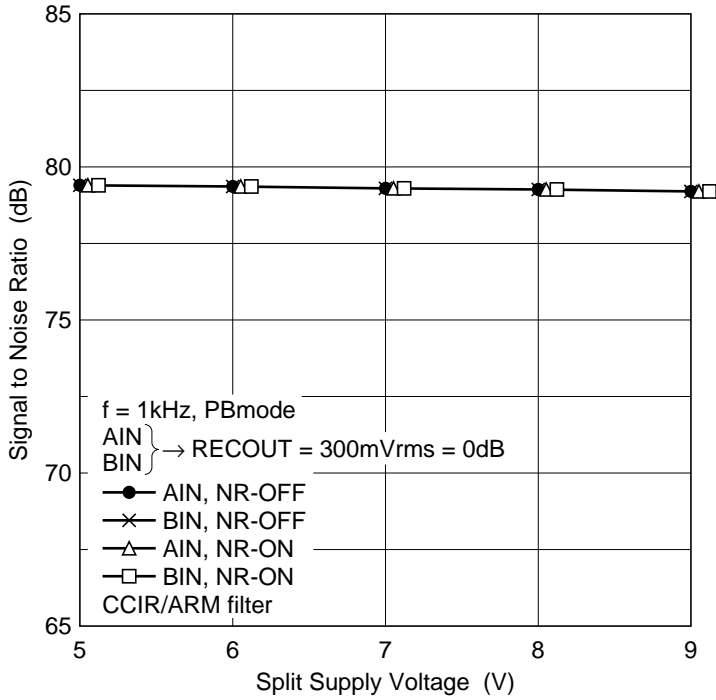

Signal to Noise Ratio vs. Split Supply Voltage (4)

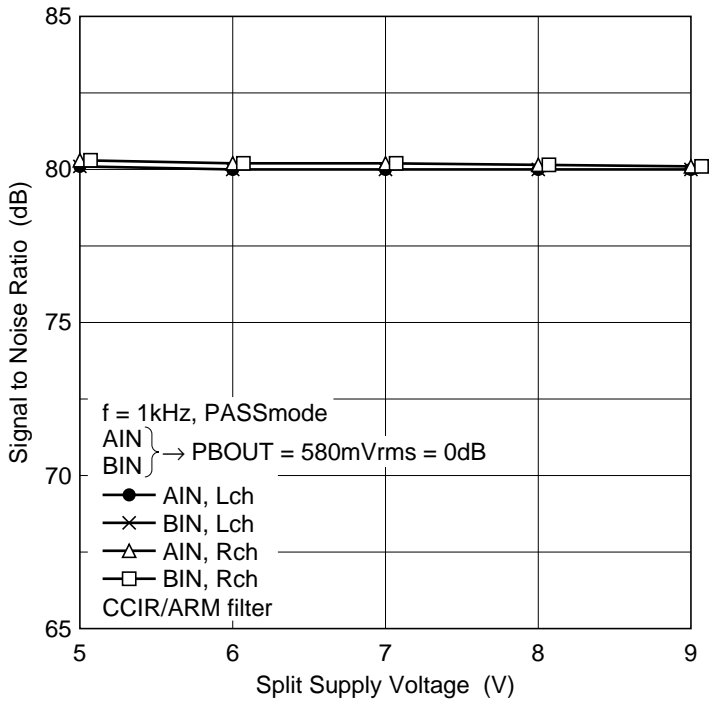

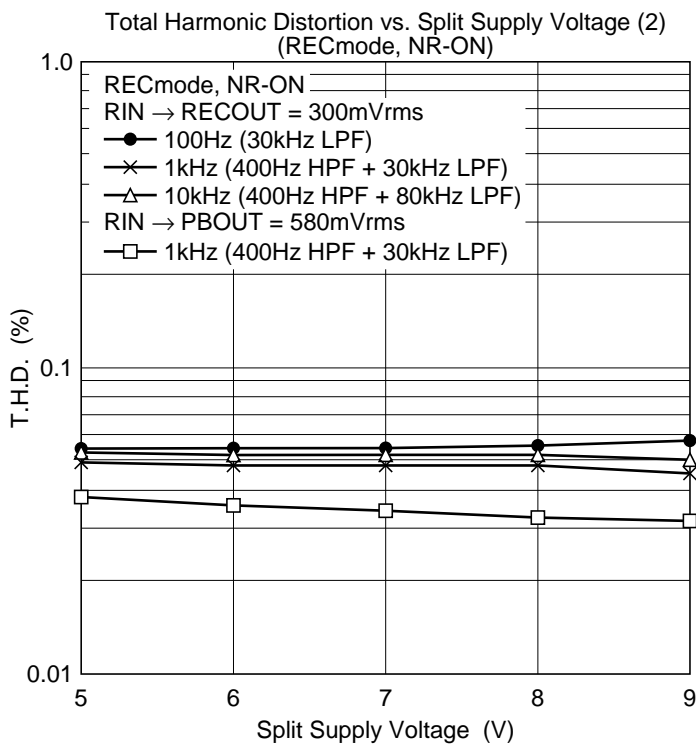
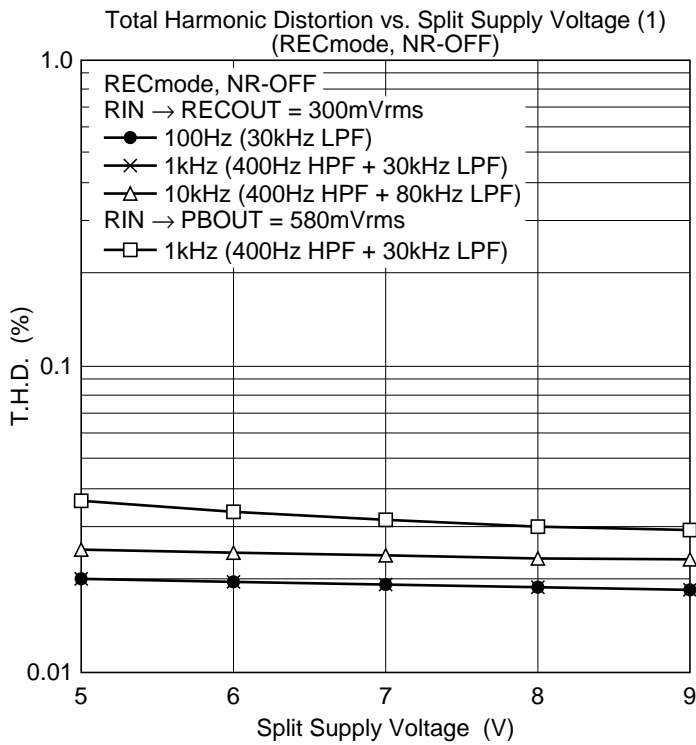

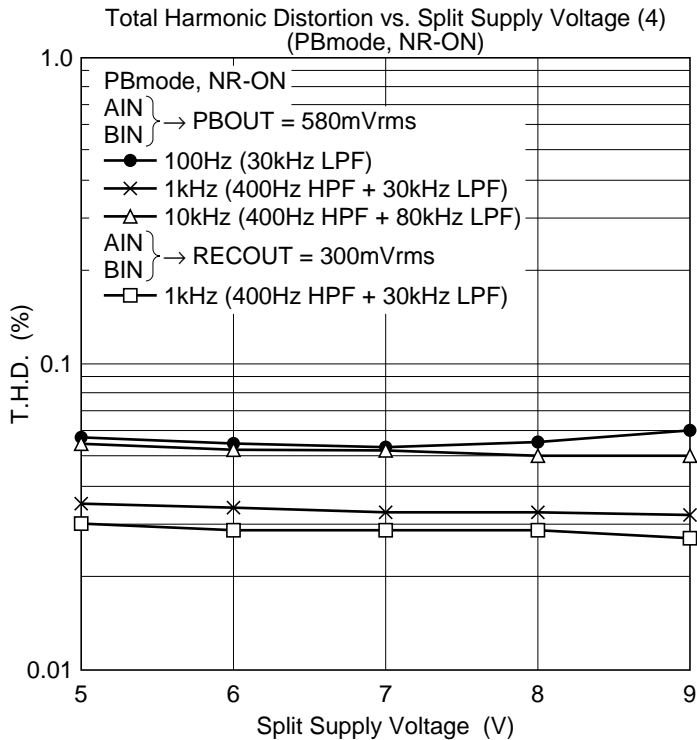
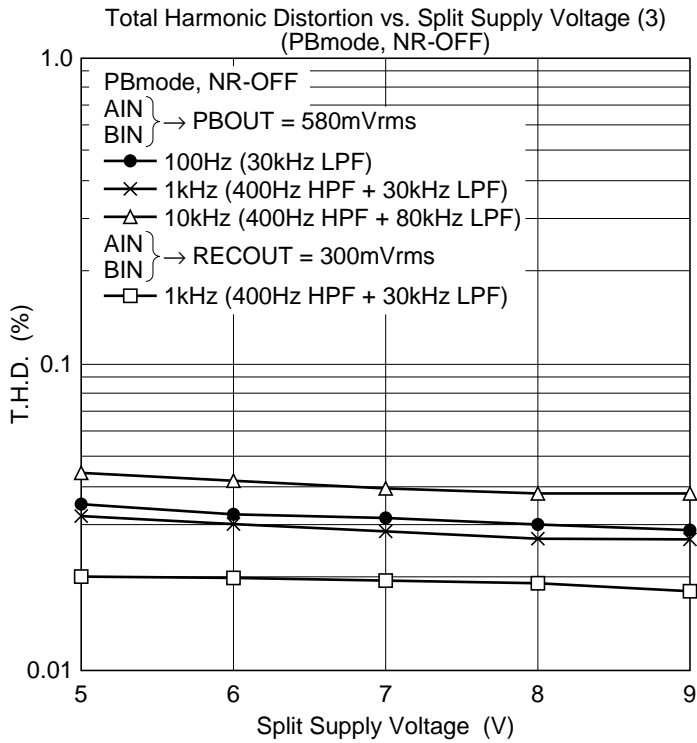

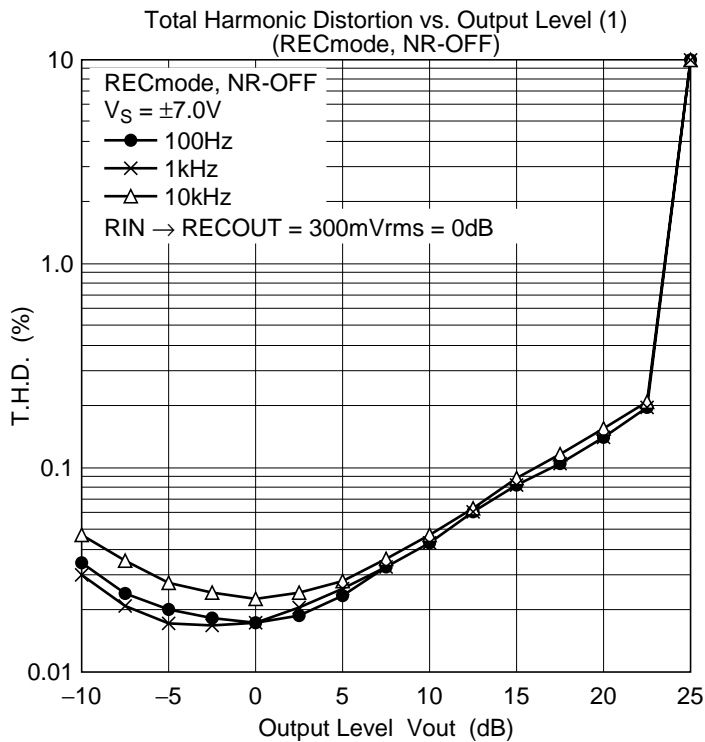
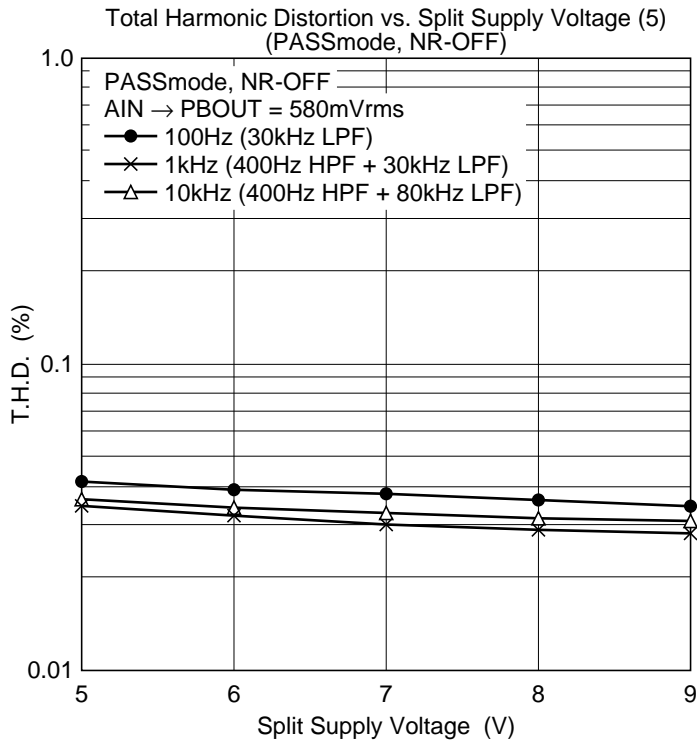

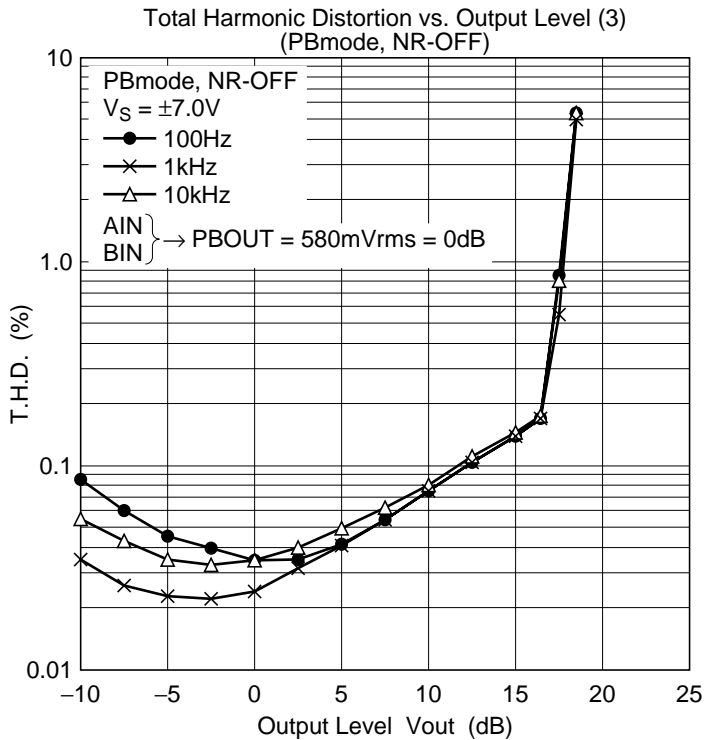
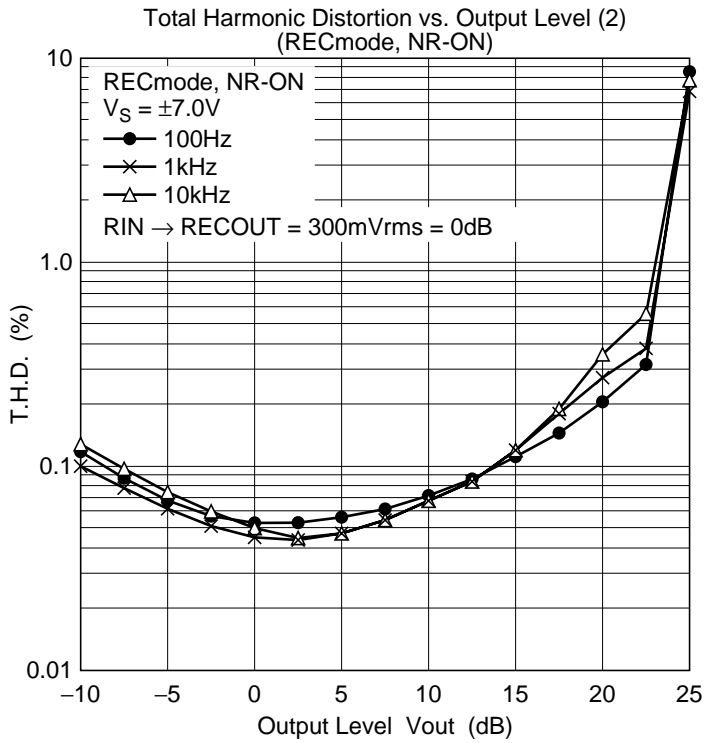



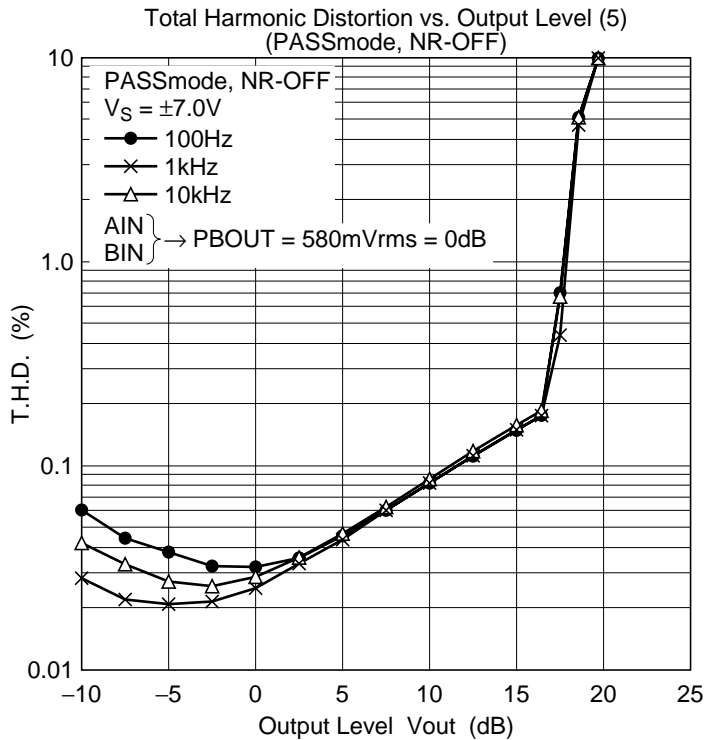
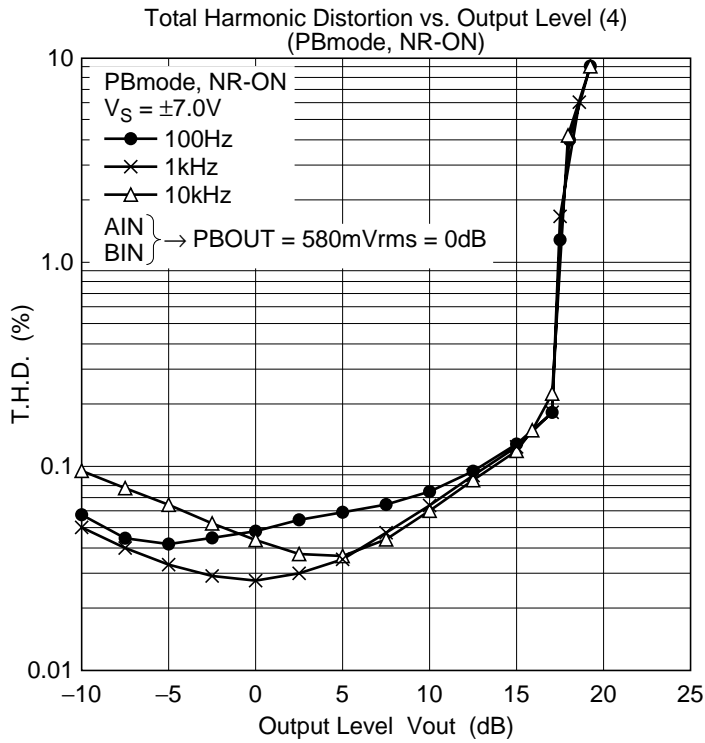

Total Harmonic Distortion vs. Frequency (1)

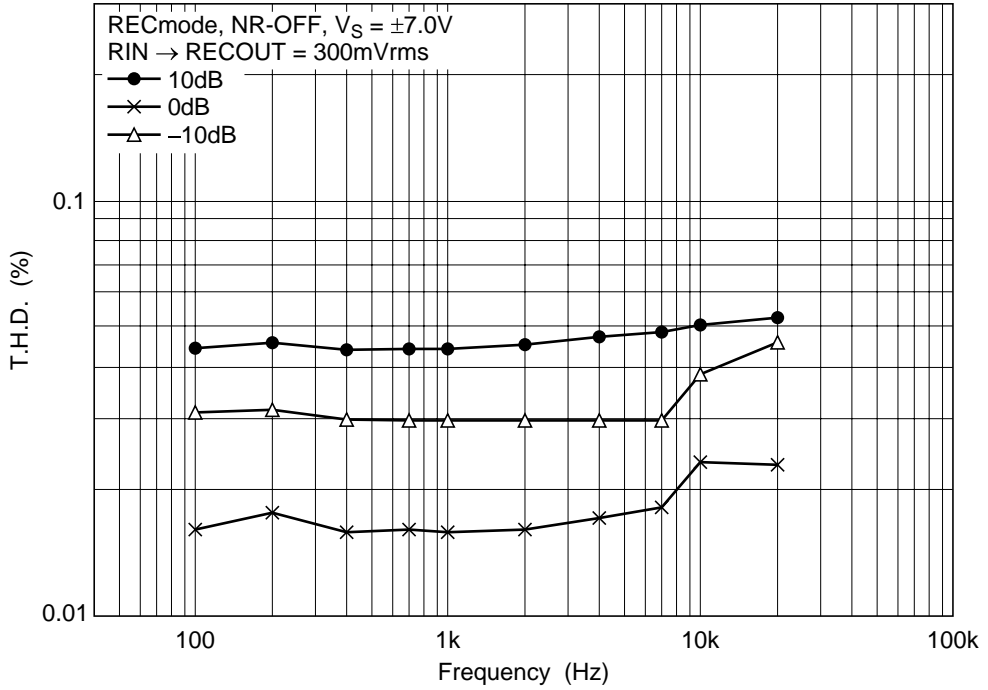

Total Harmonic Distortion vs. Frequency (2)

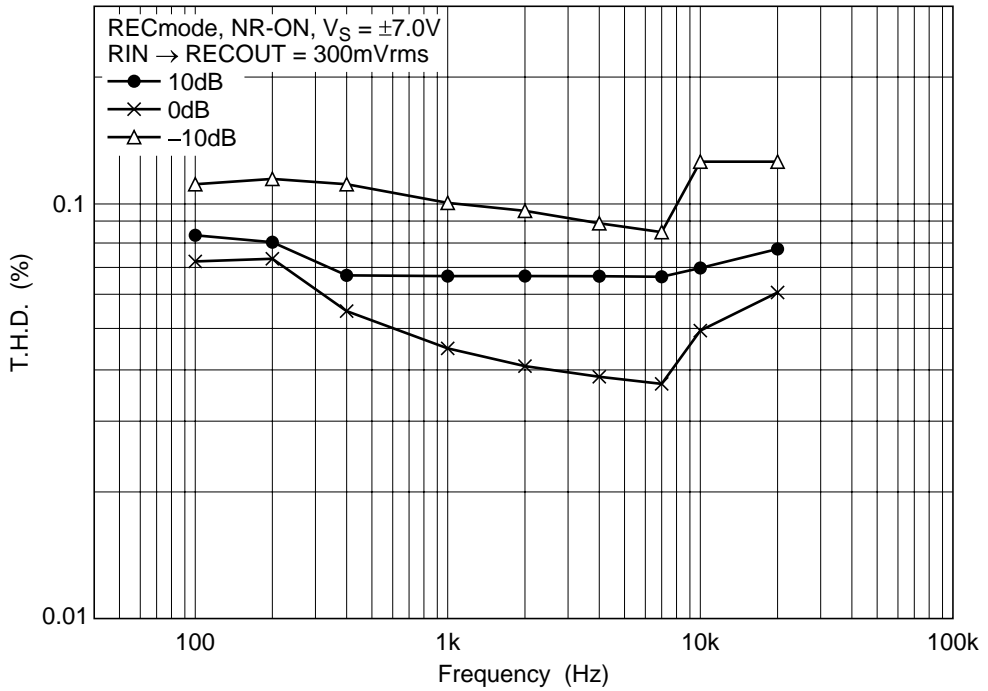

Total Harmonic Distortion vs. Frequency (3)

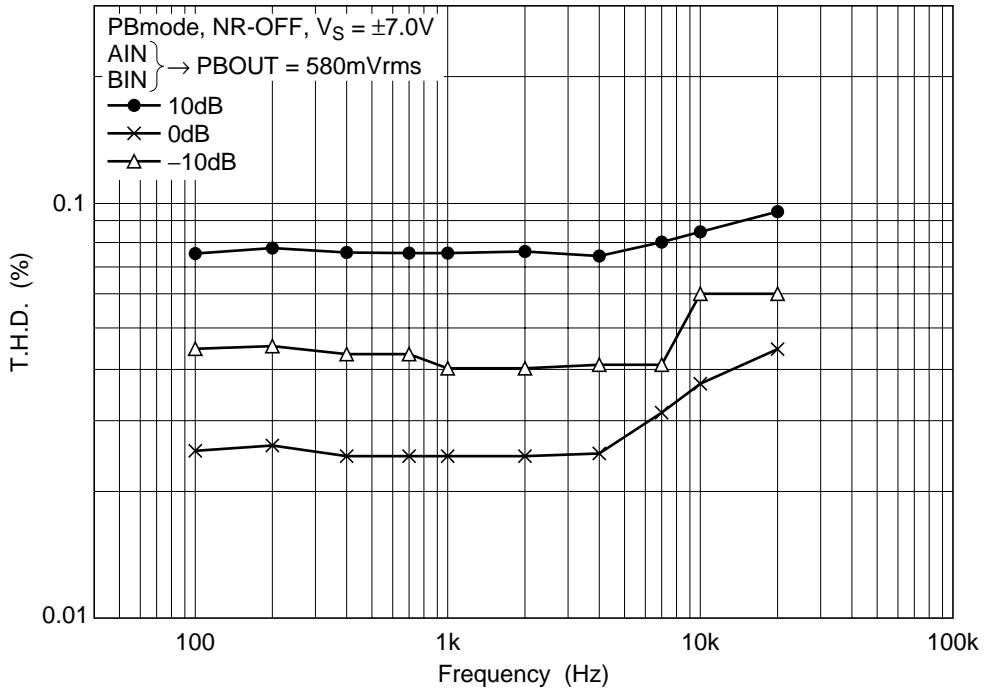

Total Harmonic Distortion vs. Frequency (4)

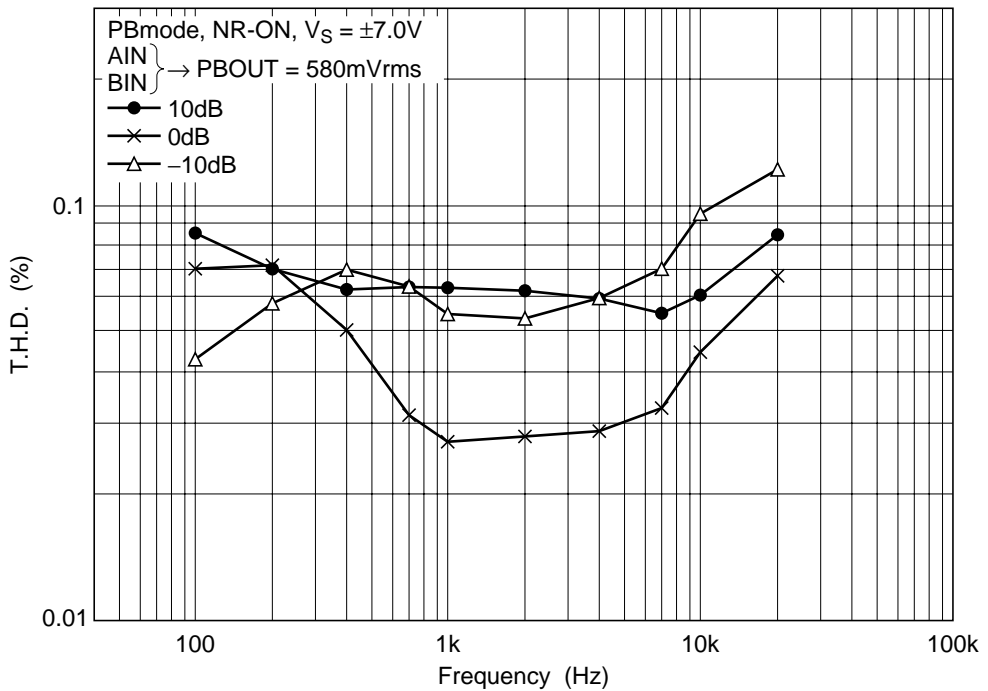

Total Harmonic Distortion vs. Frequency (5)

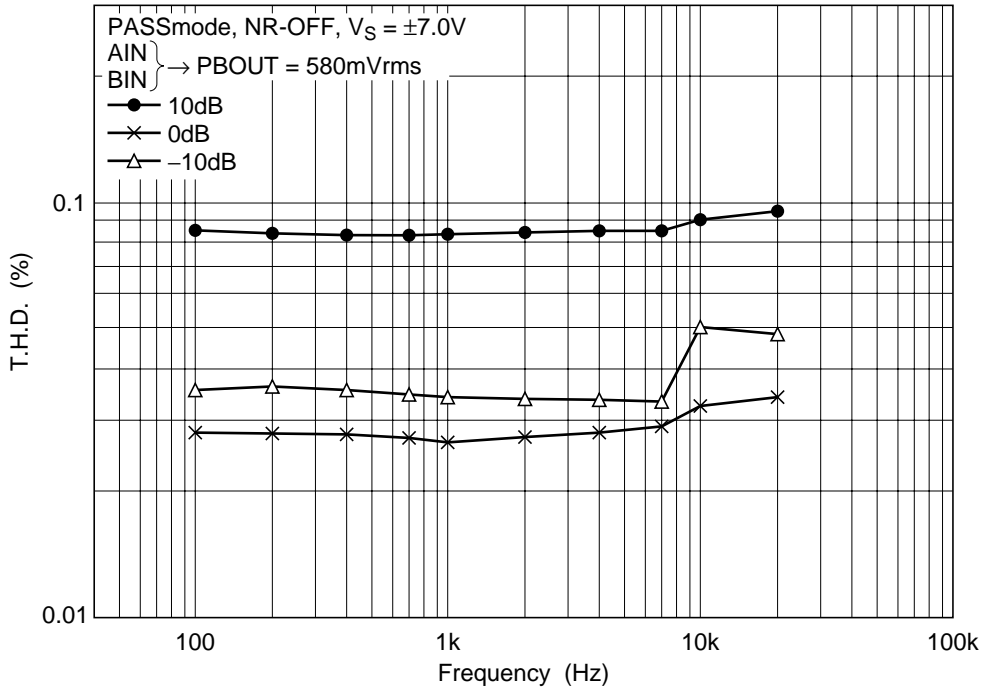

Channel Separation vs. Frequency (R→L) (1)

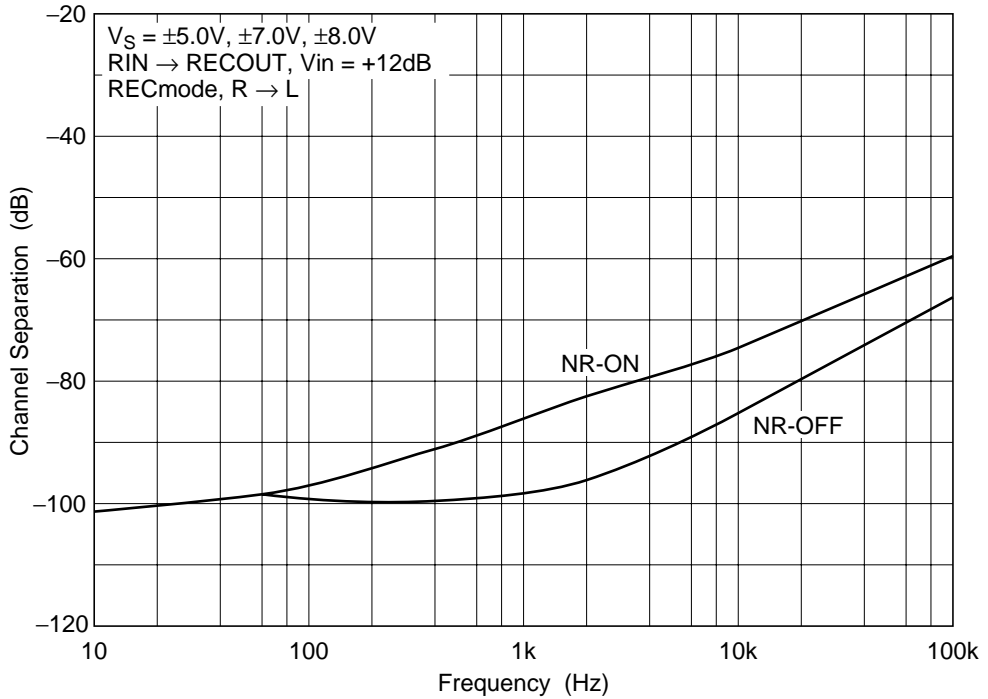

Channel Separation vs. Frequency (R→L) (2)

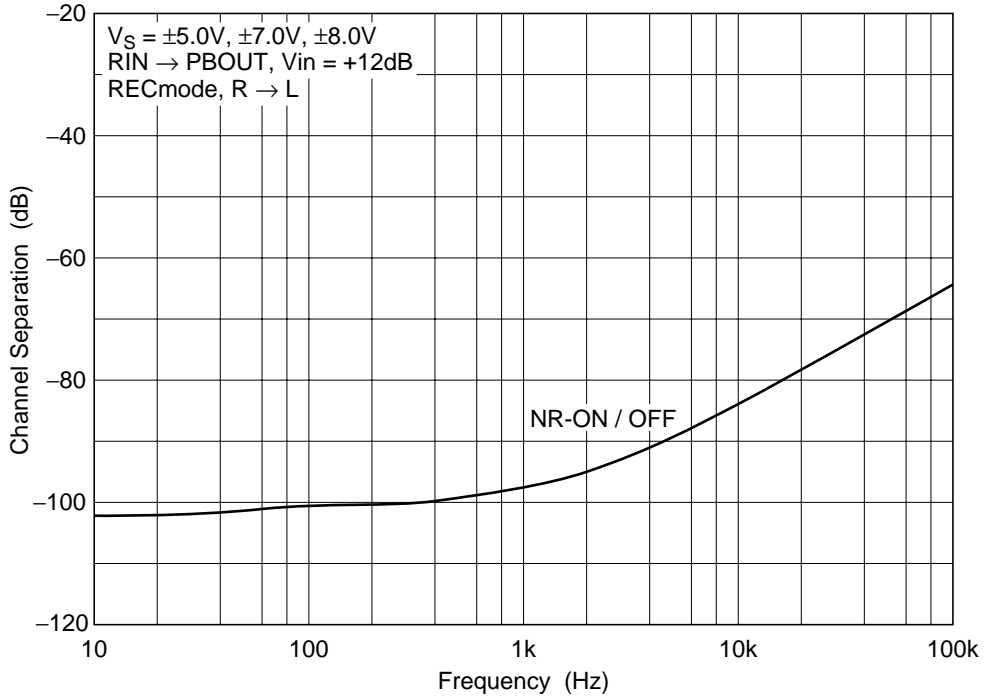

Channel Separation vs. Frequency (L→R) (3)

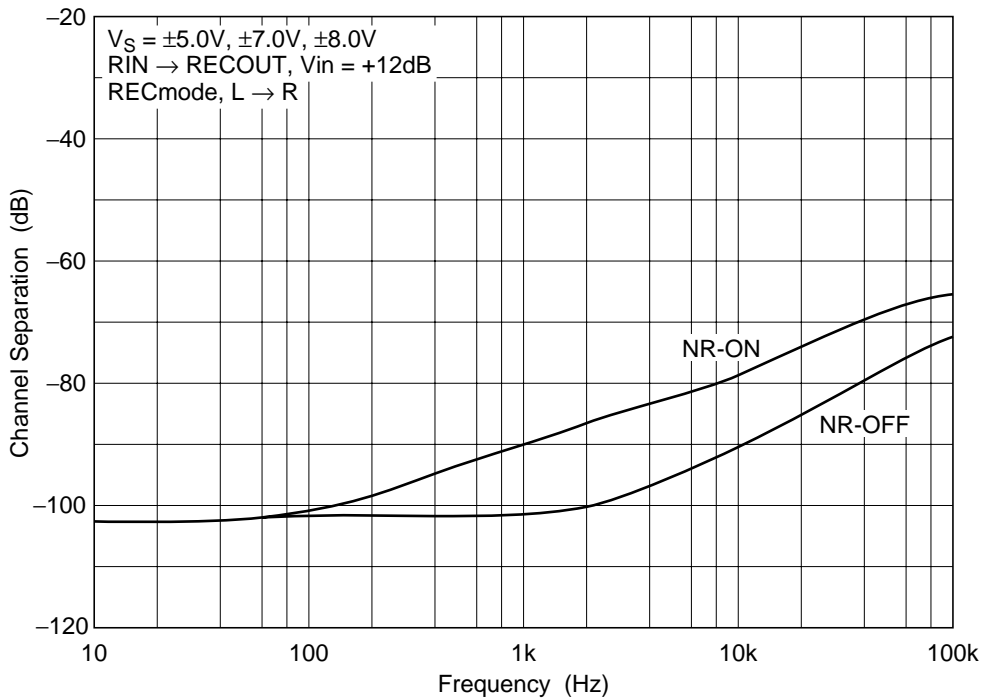

### Channel Separation vs. Frequency (L→R) (4)

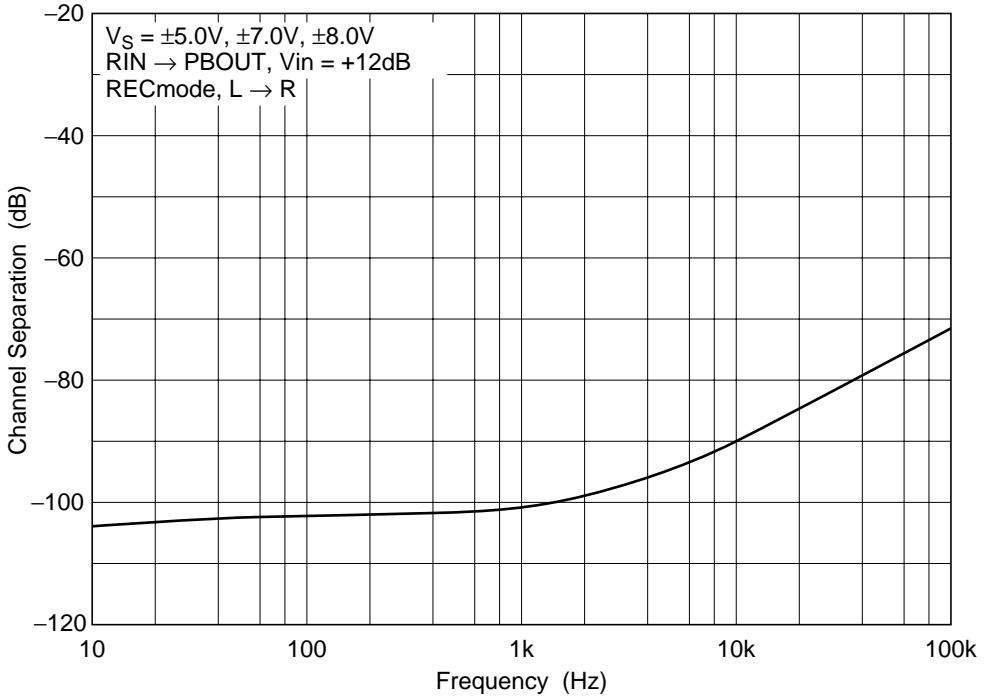

### Channel Separation vs. Frequency (R→L) (1)

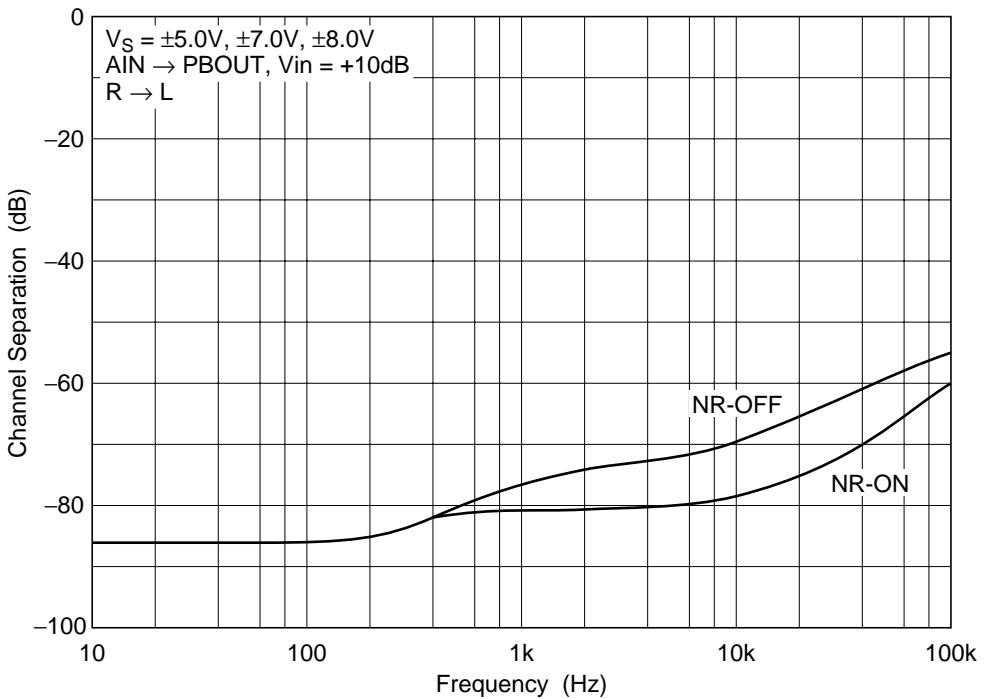

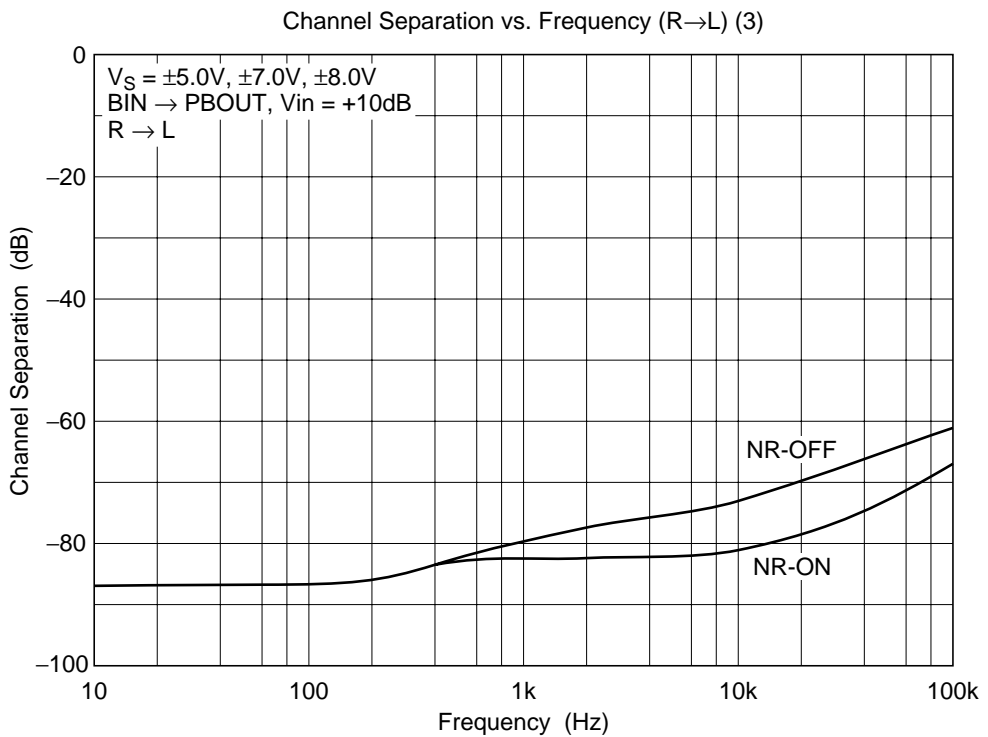
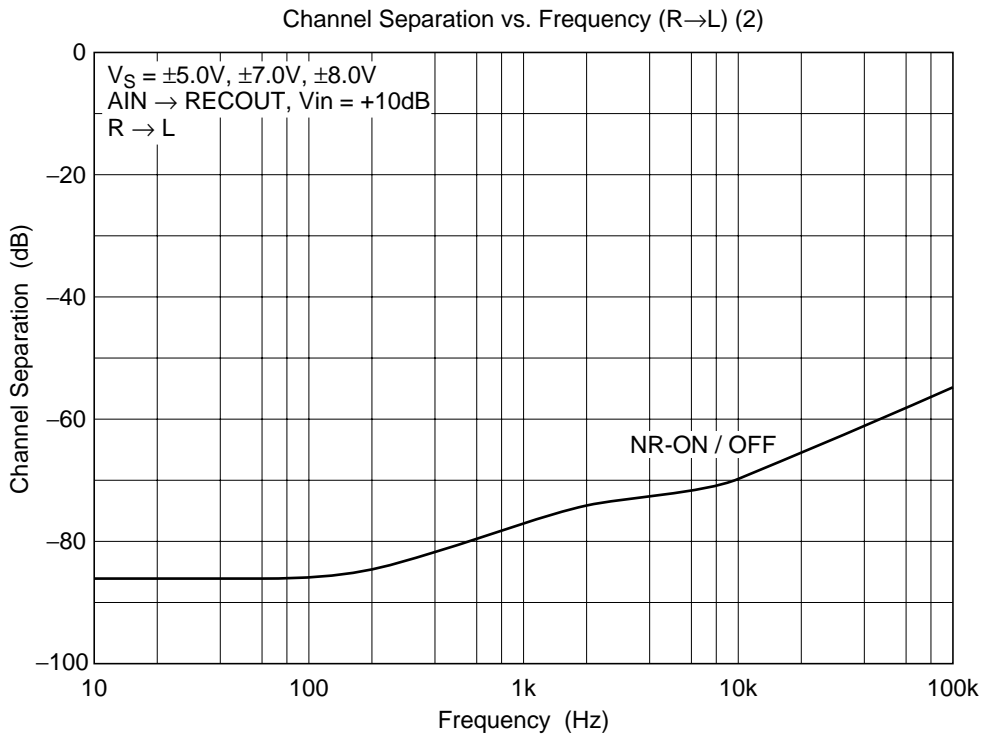

Channel Separation vs. Frequency (R→L) (4)

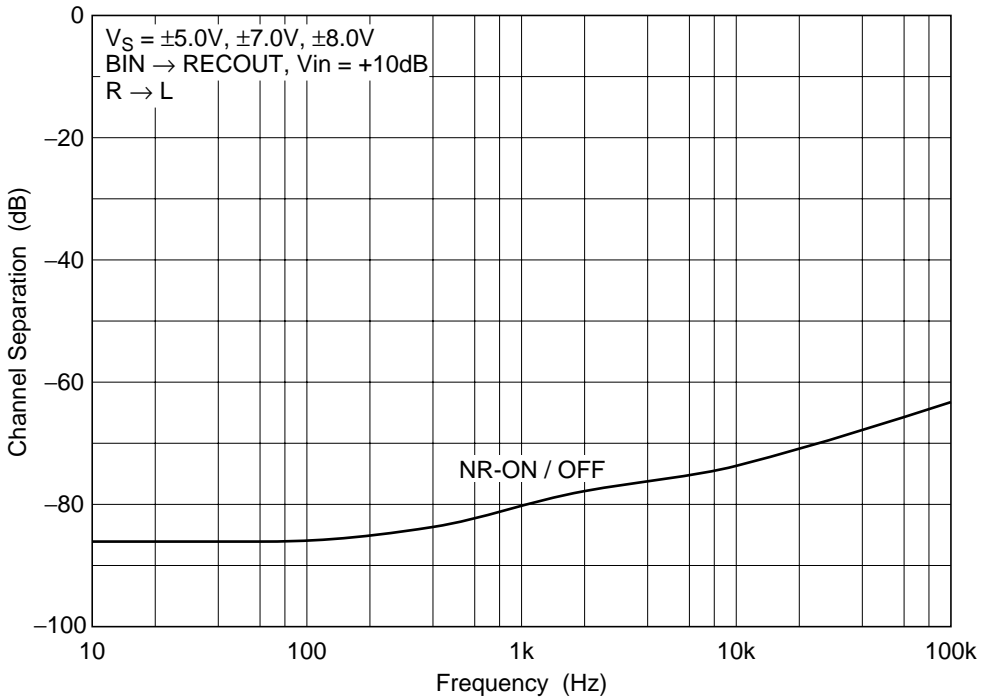

Channel Separation vs. Frequency (L→R) (5)

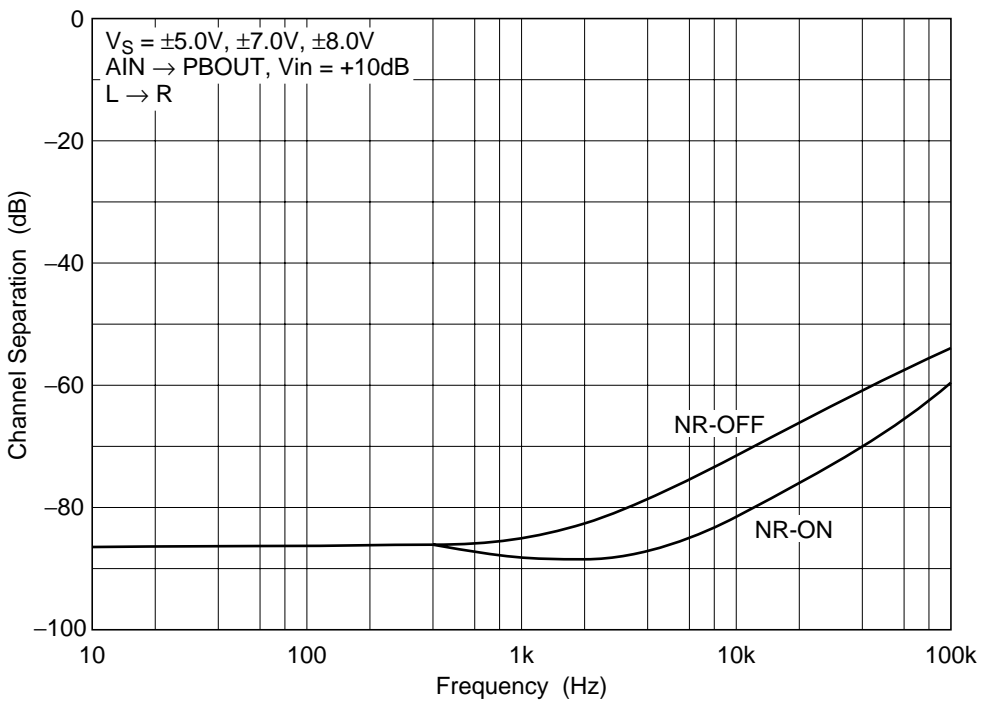



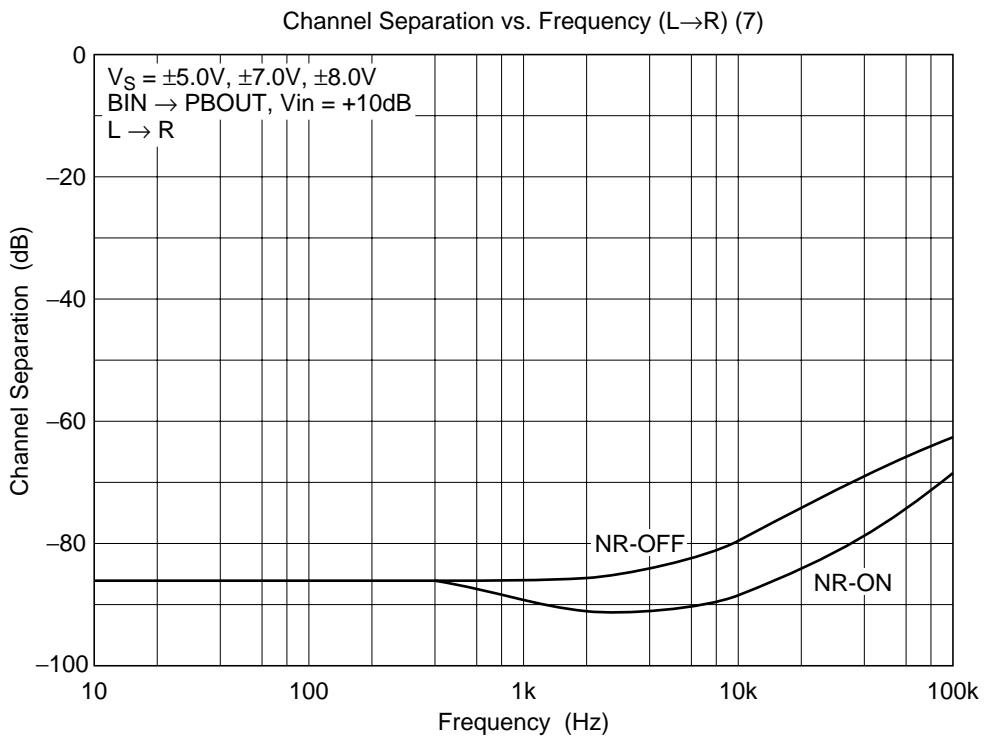
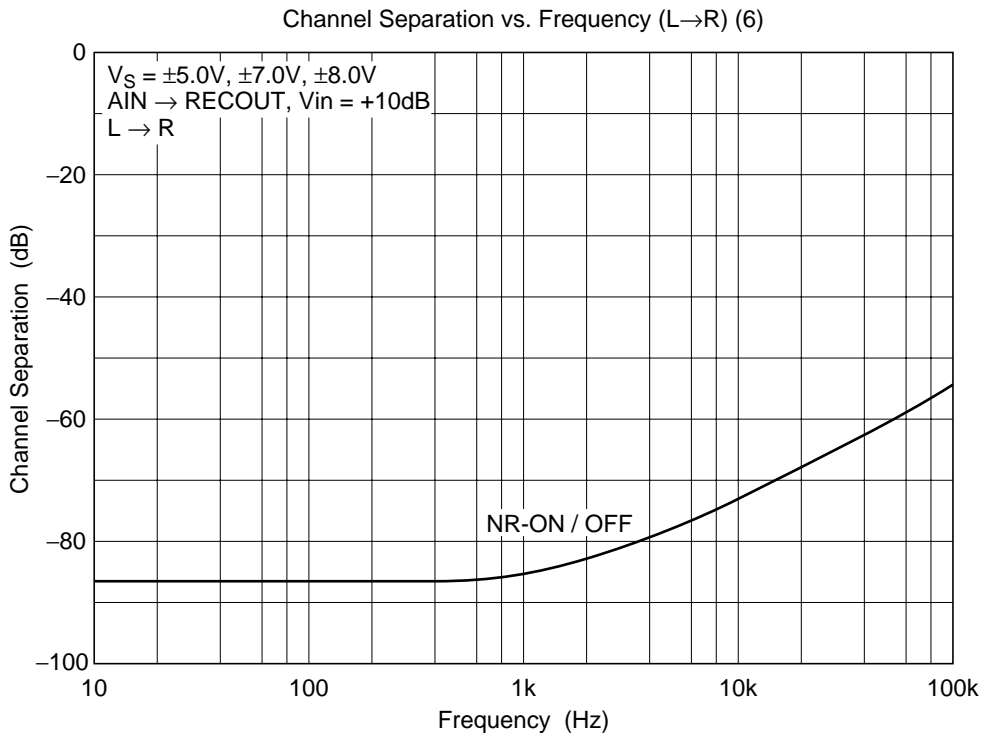

### Channel Separation vs. Frequency (L→R) (8)

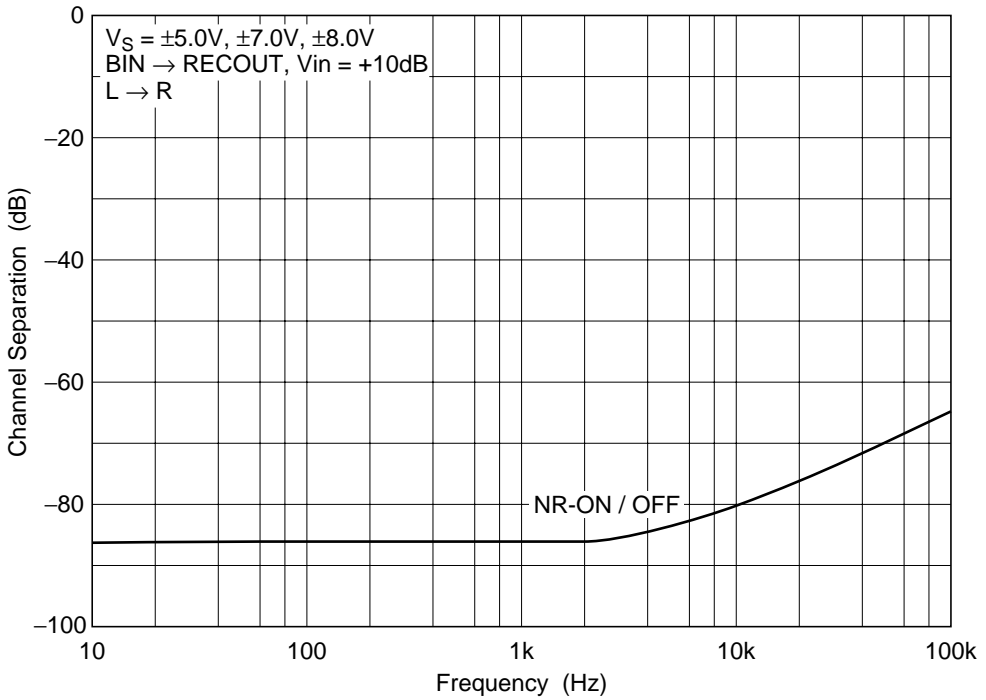

### Channel Separation vs. Frequency (R→L) (1)

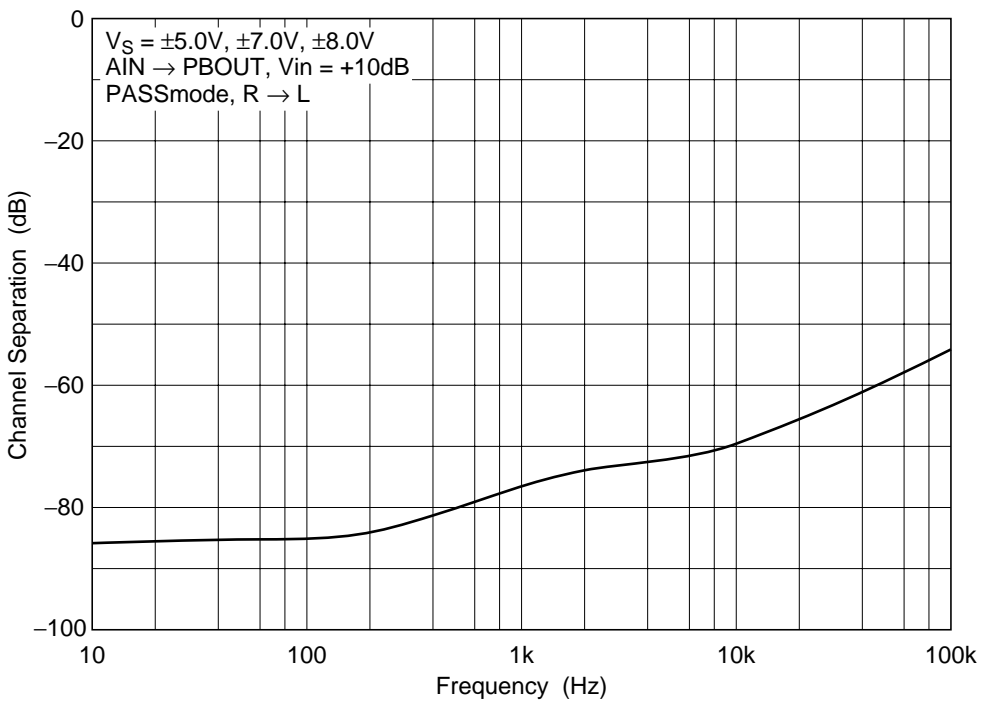

Channel Separation vs. Frequency (R→L) (2)

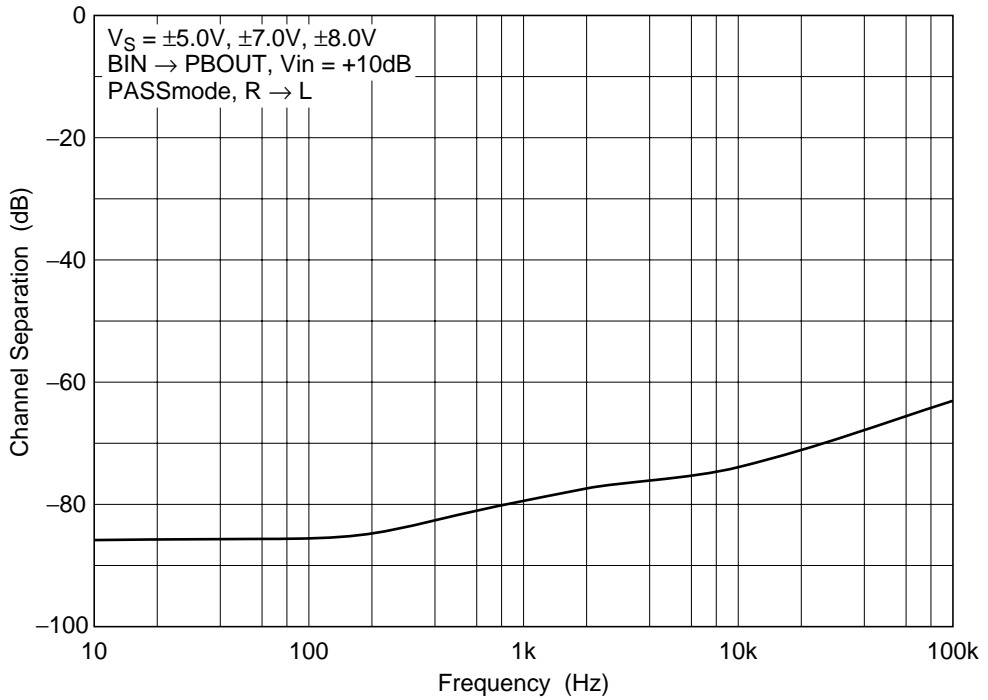

Channel Separation vs. Frequency (L→R) (3)

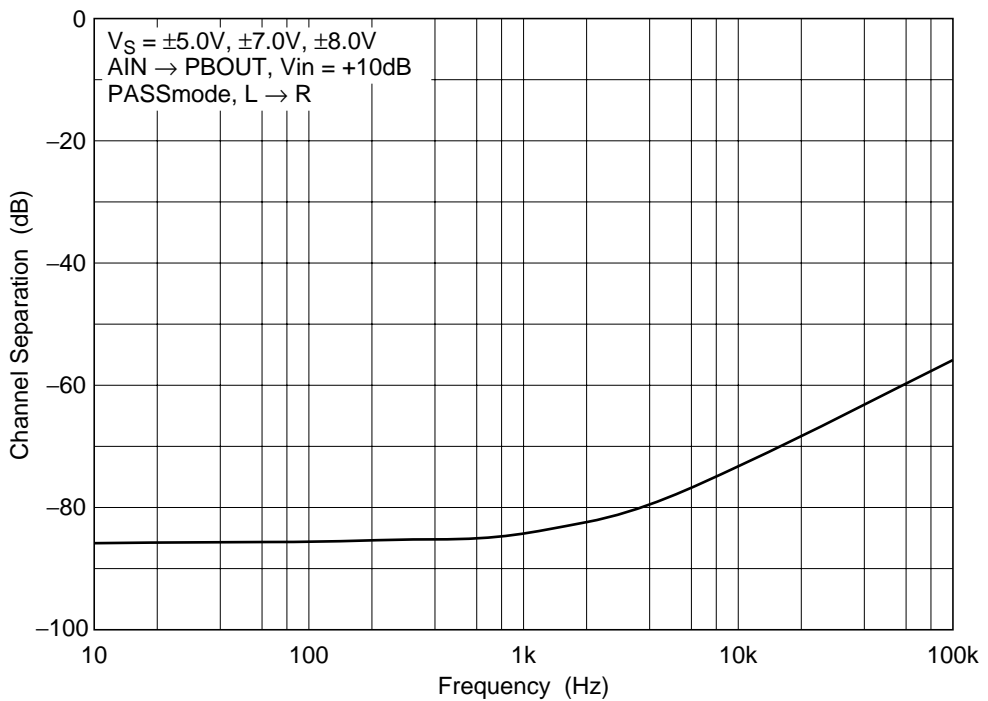

### Channel Separation vs. Frequency (L→R) (4)

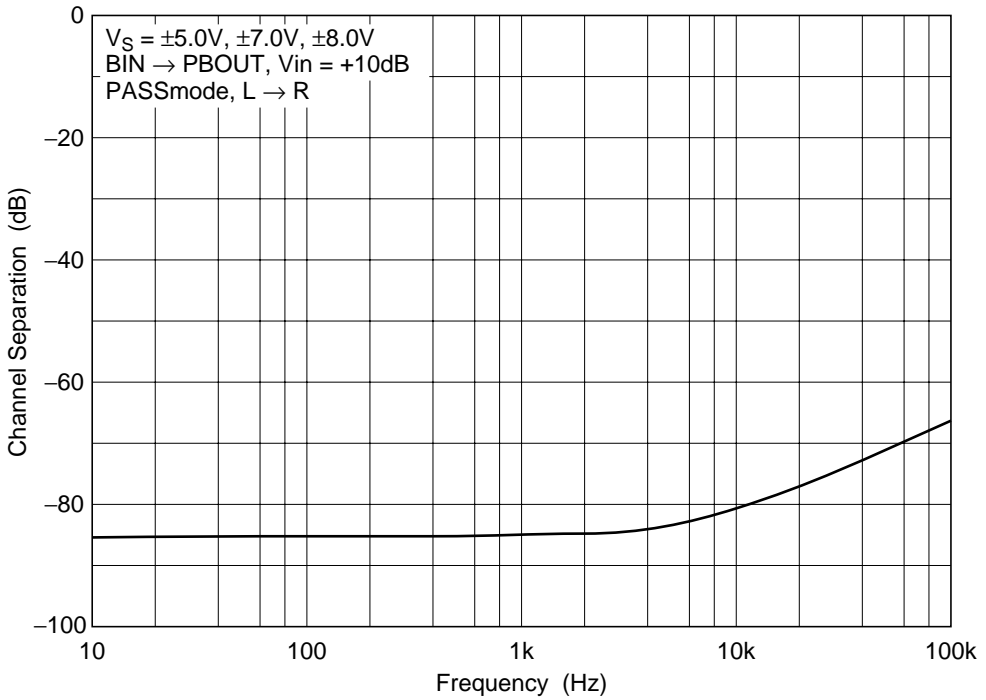

### Crosstalk vs. Frequency (AIN→BIN) (1)

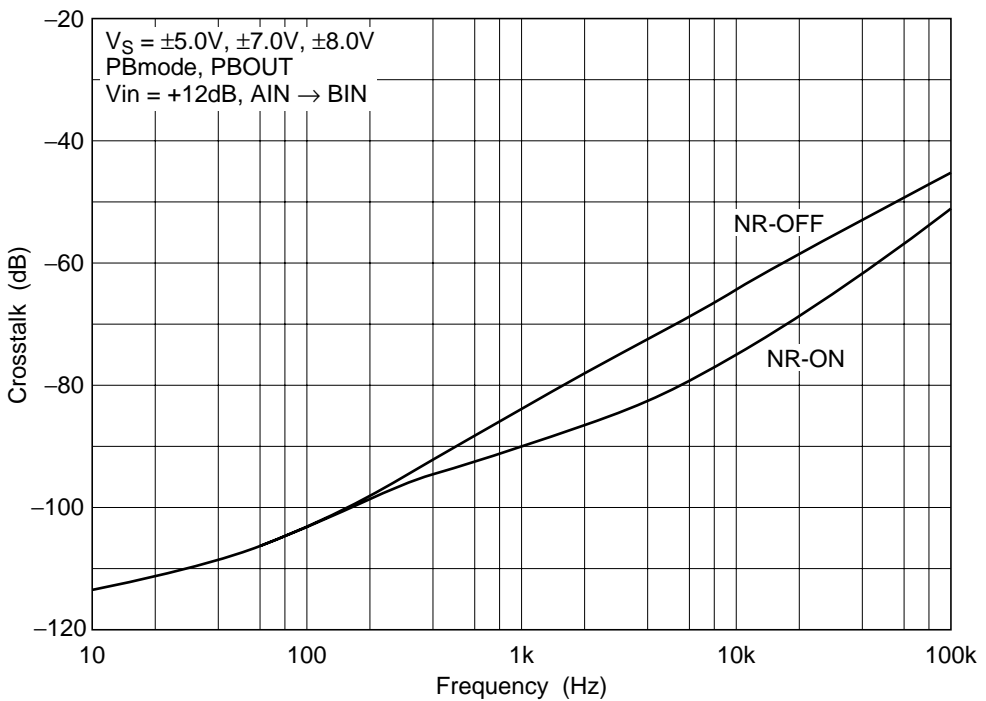

Crosstalk vs. Frequency (BIN→AIN) (2)

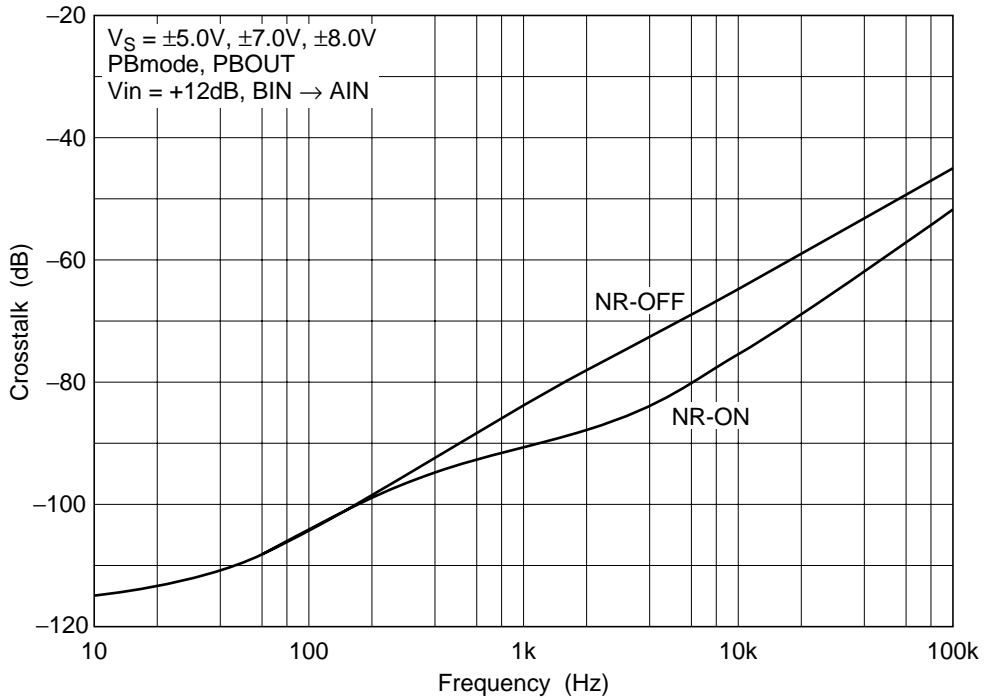

Crosstalk vs. Frequency (AIN→BIN) (3)

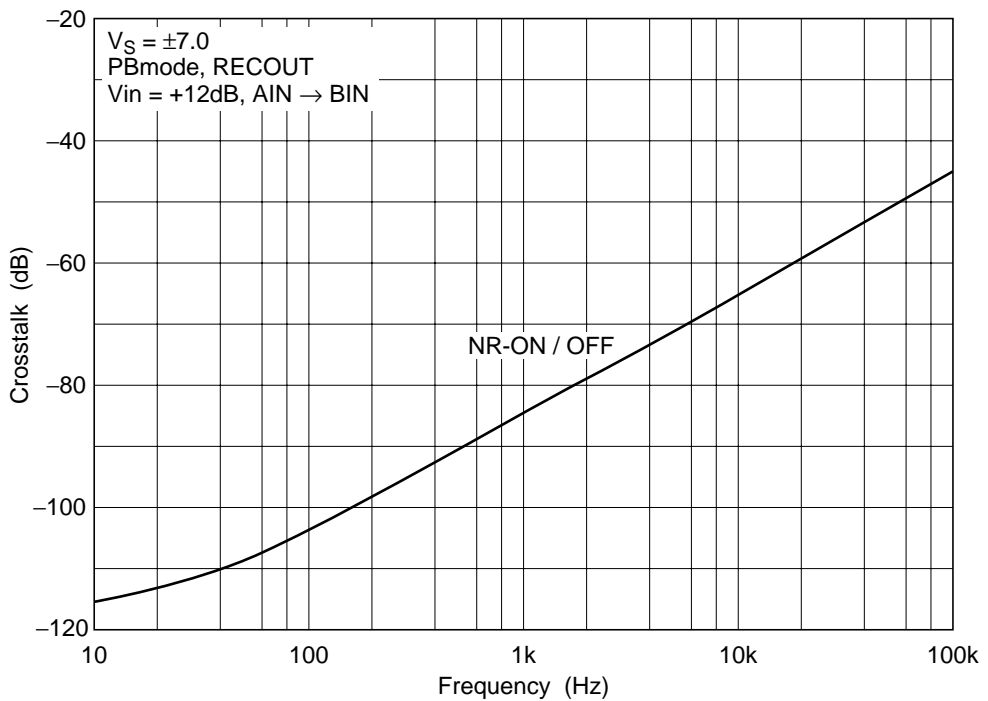

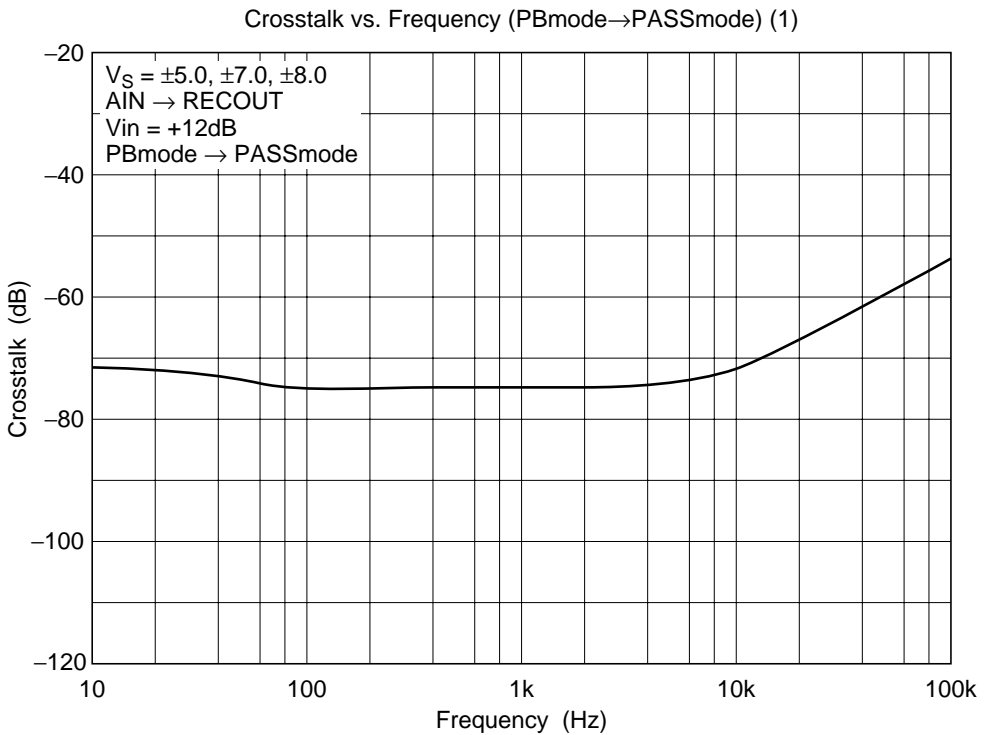
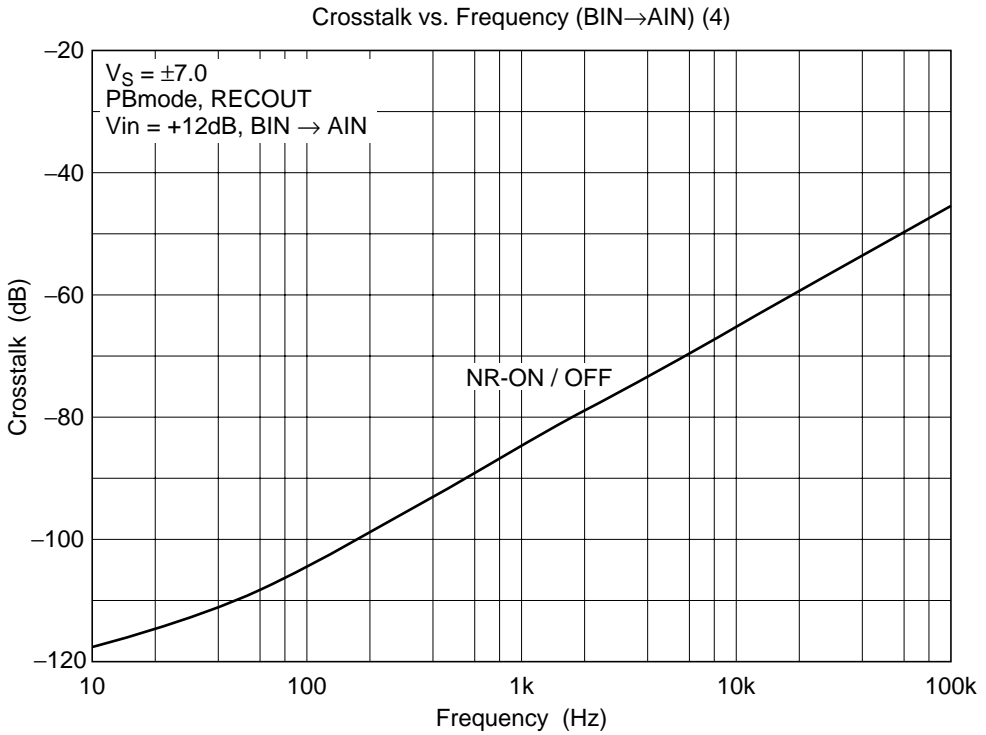

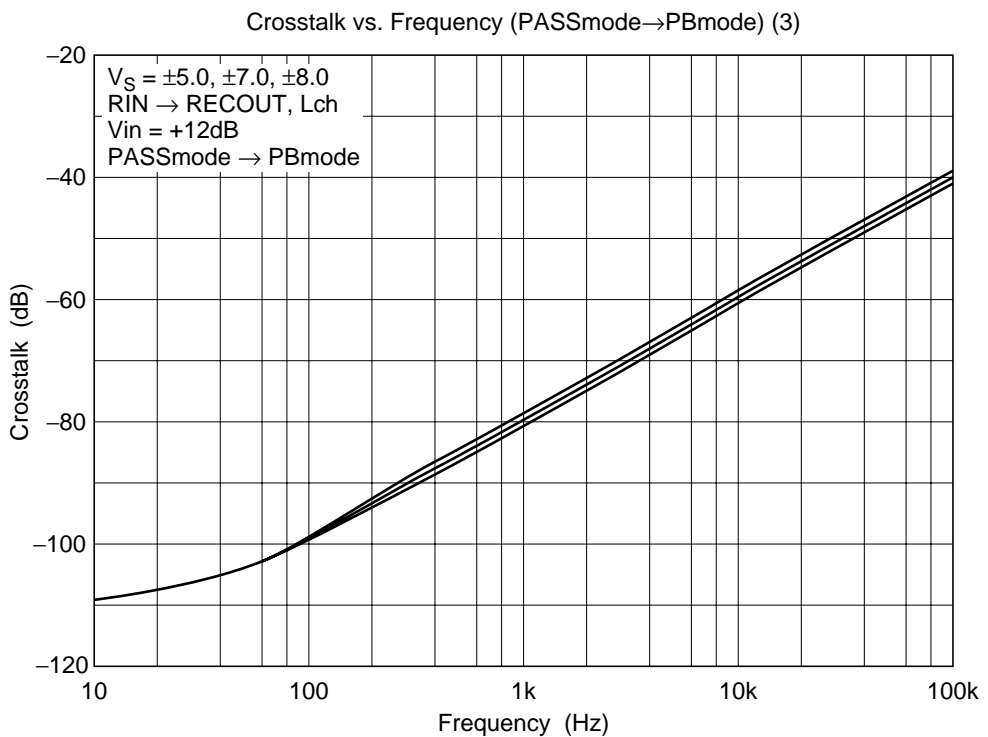
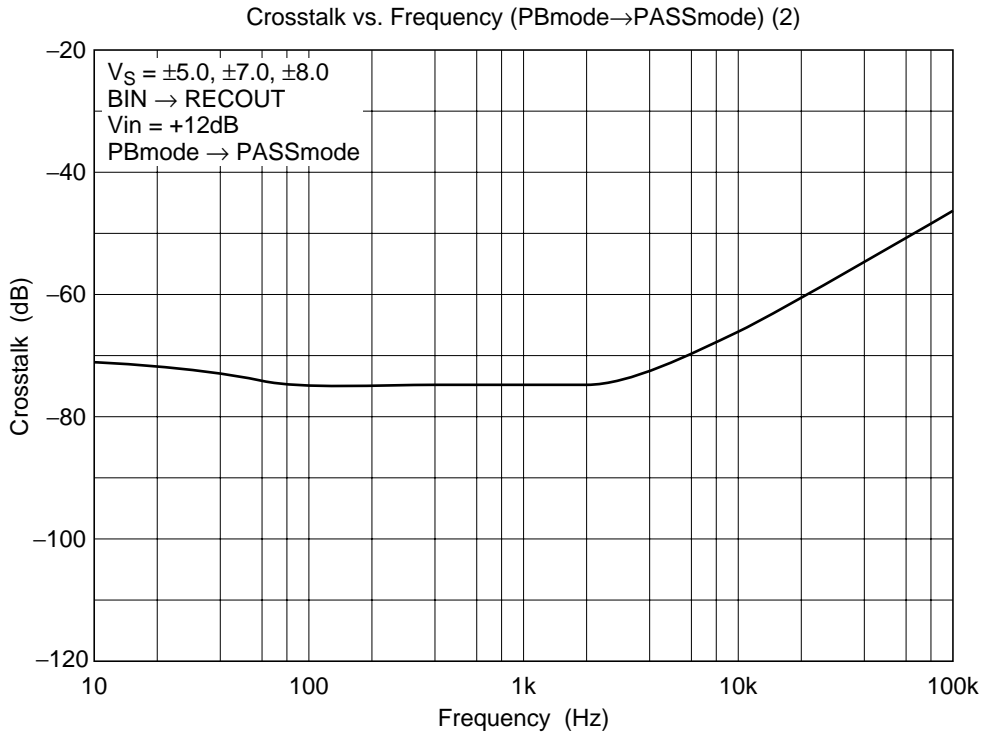

Crosstalk vs. Frequency (RECmode→PASSmode) (Rch) (1)

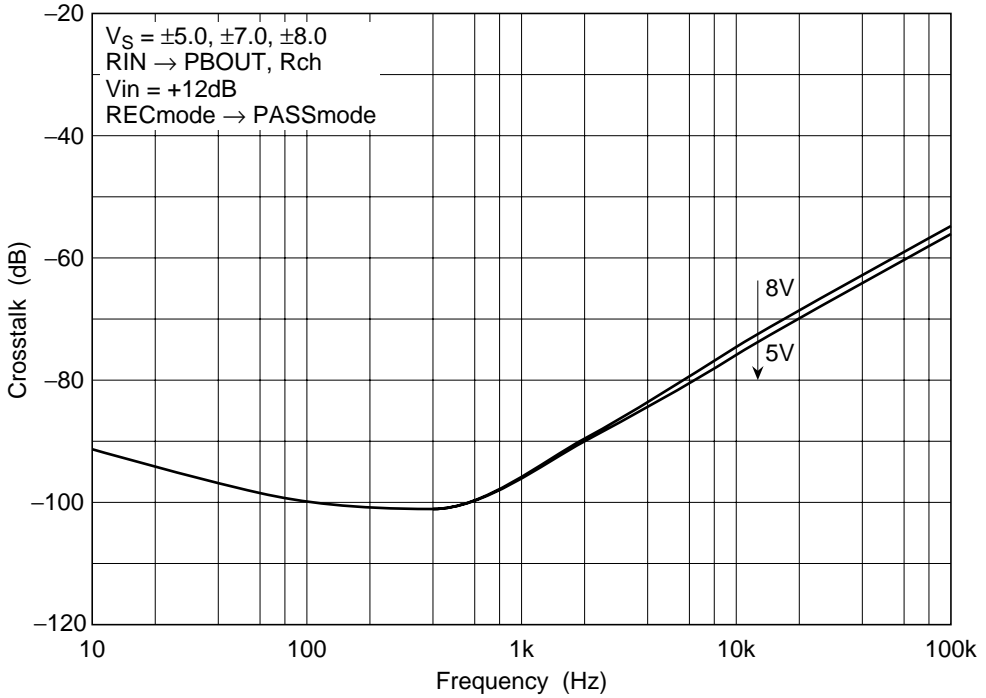

Crosstalk vs. Frequency (RECmode→PASSmode) (Lch) (2)

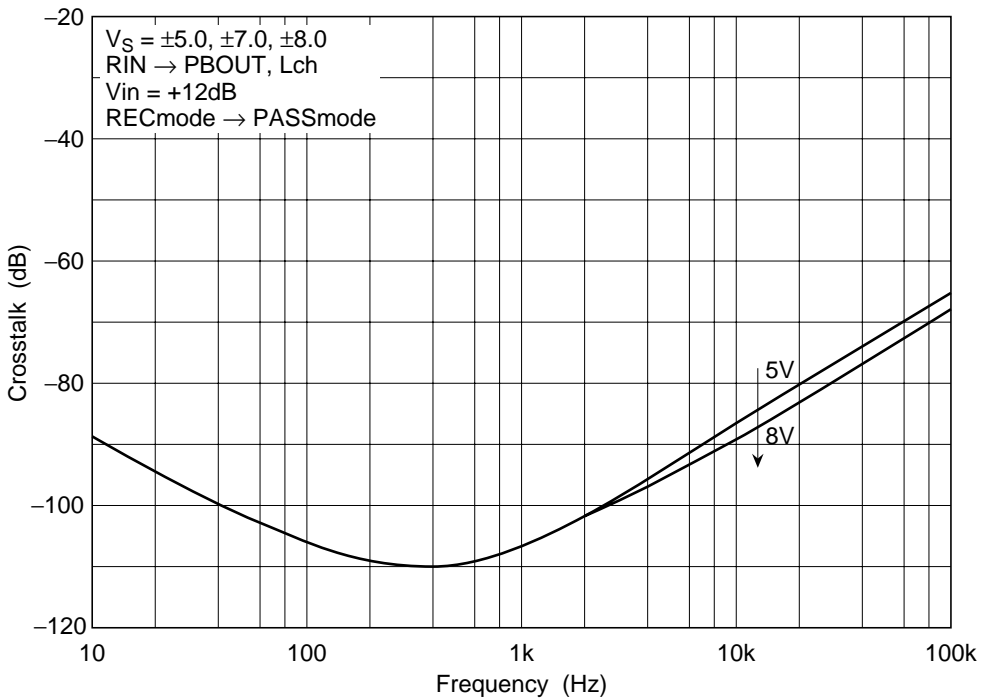



Crosstalk vs. Frequency (PASSmode→RECmode) (Rch) (1)

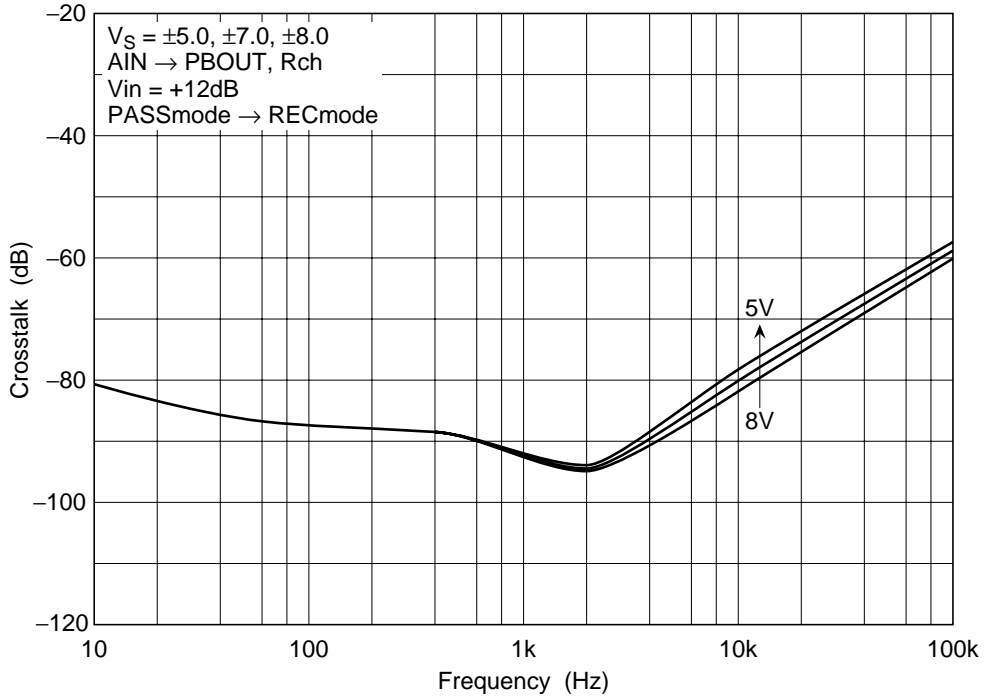

Crosstalk vs. Frequency (PASSmode→RECmode) (Rch) (2)

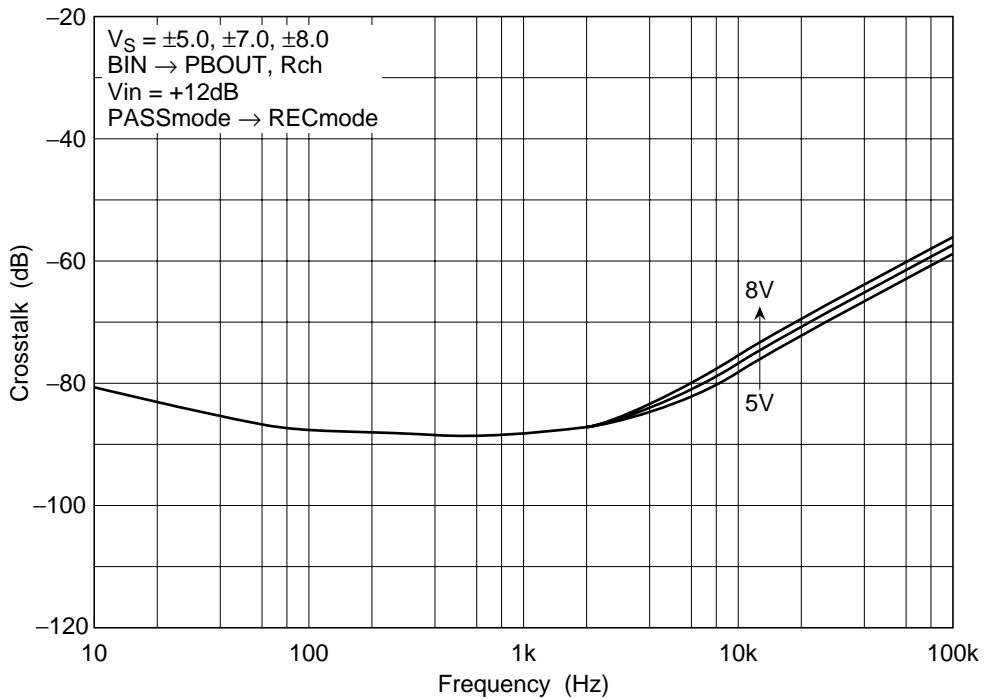

Crosstalk vs. Frequency (PASSmode→RECmode) (Lch) (3)

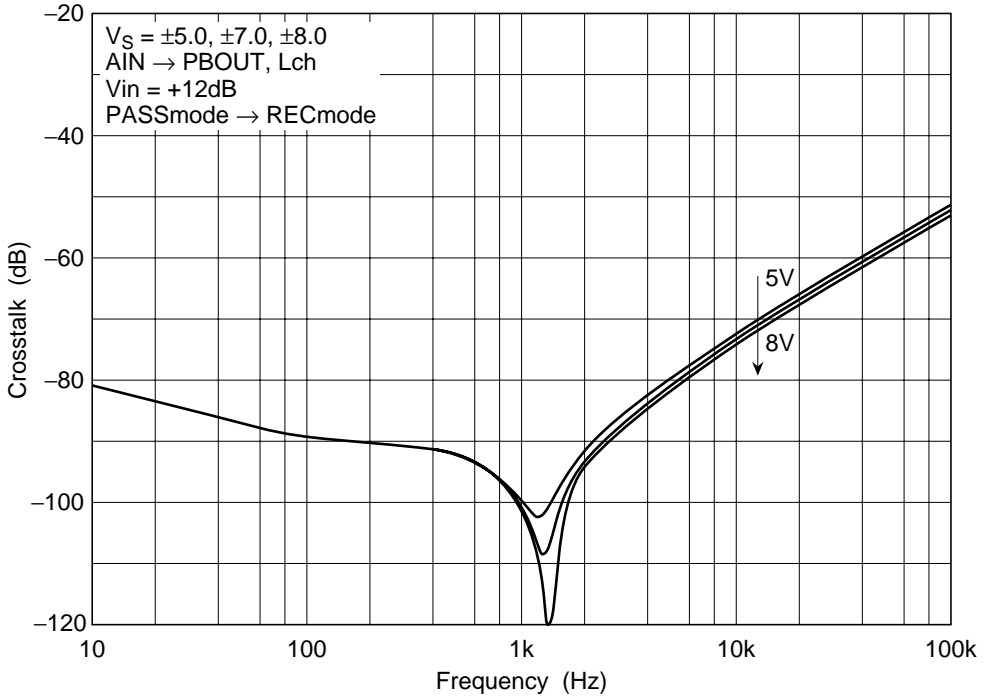

Crosstalk vs. Frequency (PASSmode→RECmode) (Lch) (4)

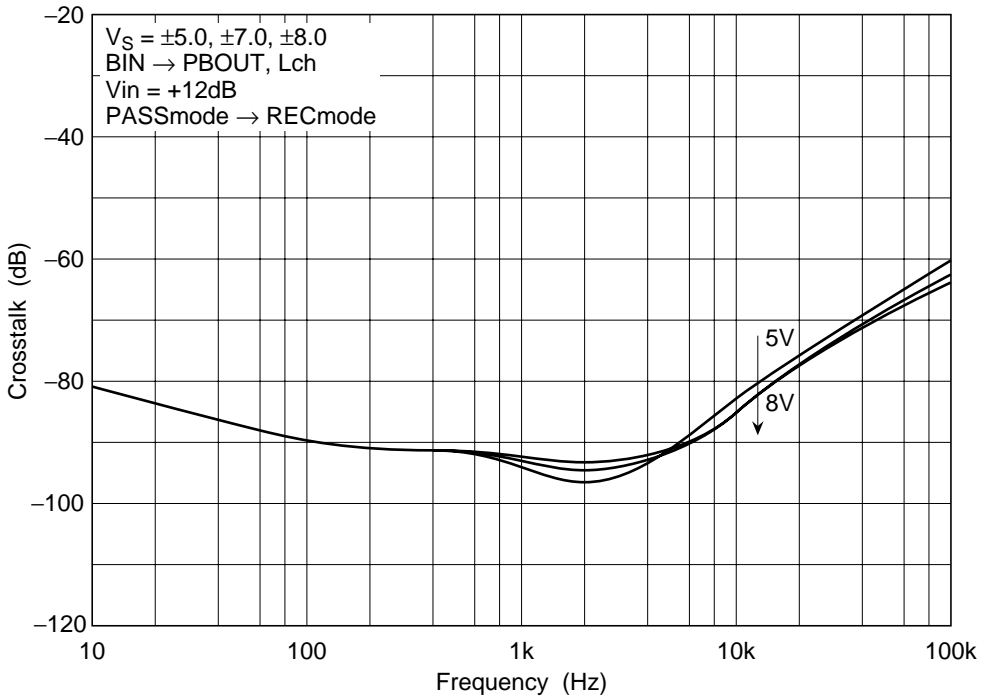

Line Mute vs. Frequency

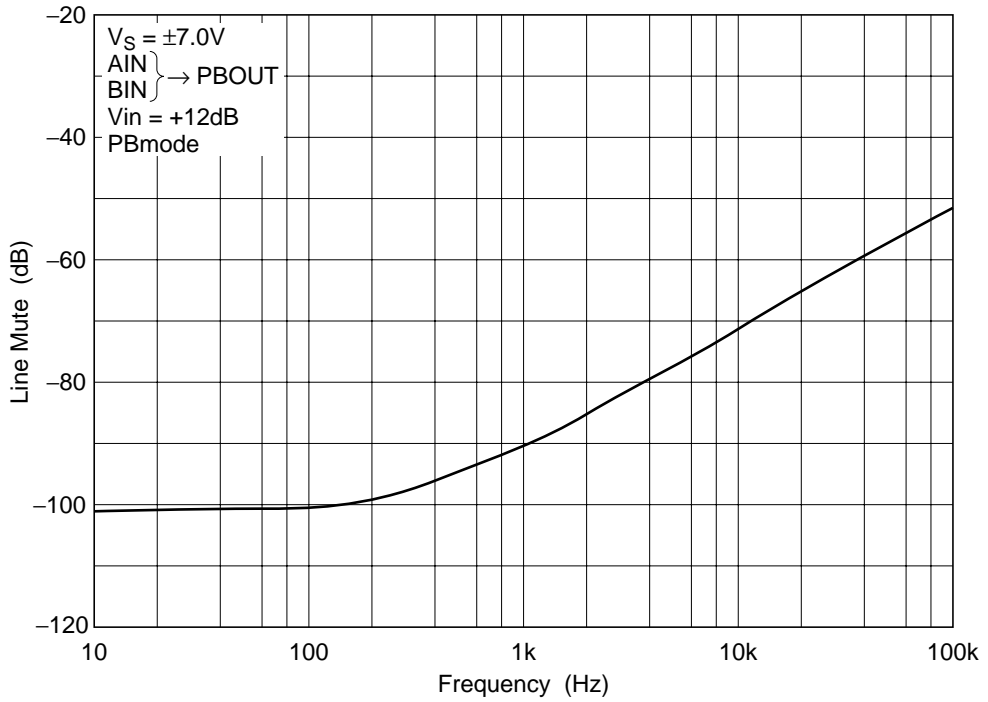

REC Mute Attenuation vs. Frequency

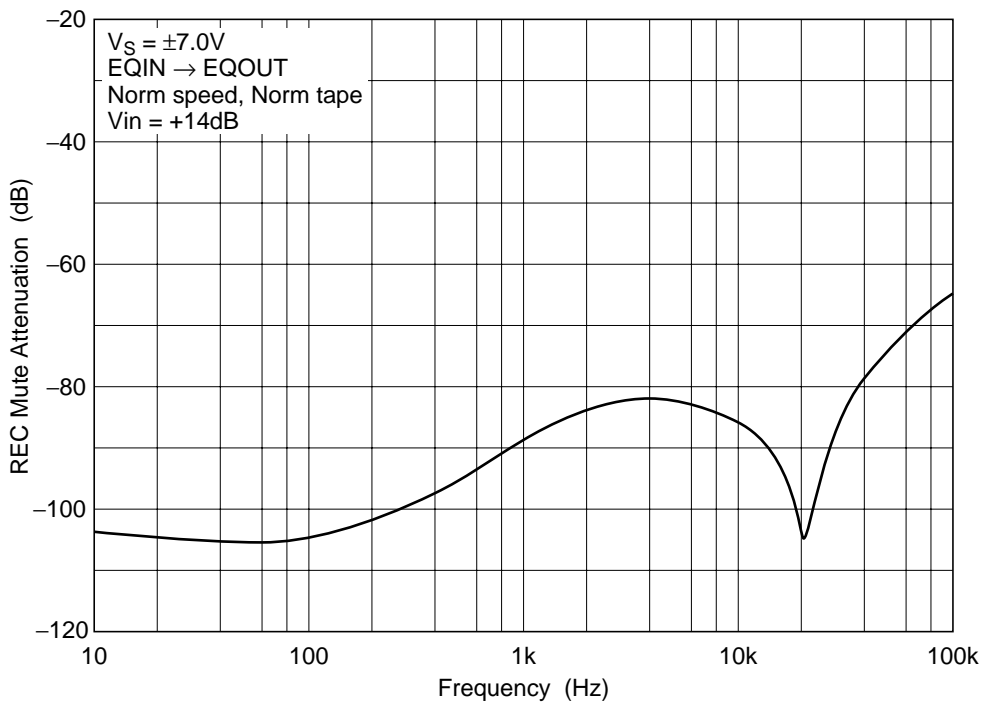

Ripple Rejection Ratio vs. Frequency (RECmode) (1)

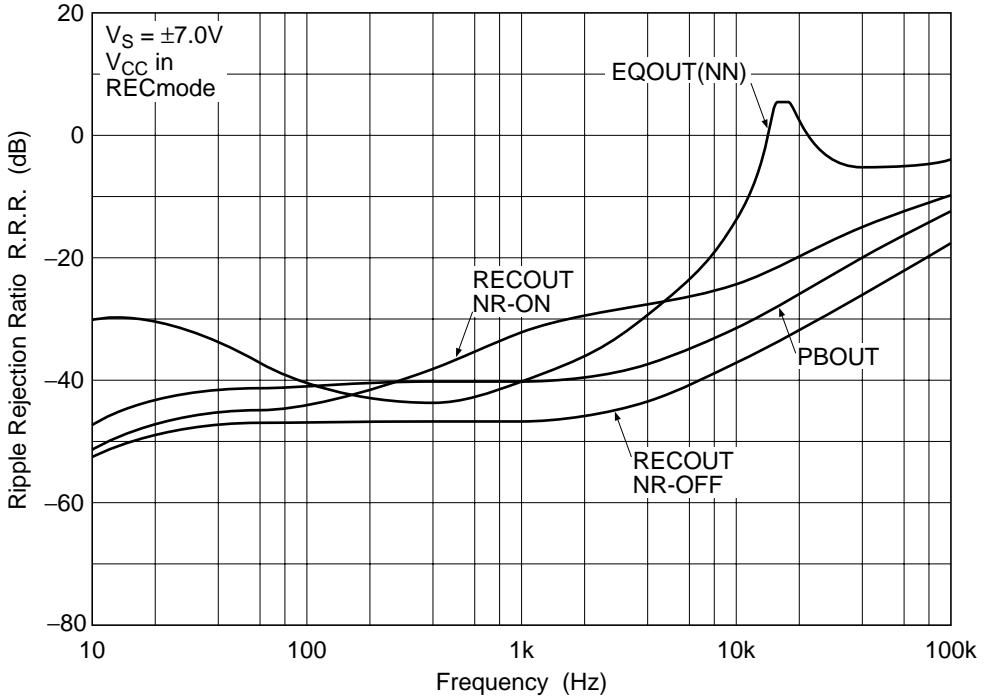

Ripple Rejection Ratio vs. Frequency (RECmode) (2)

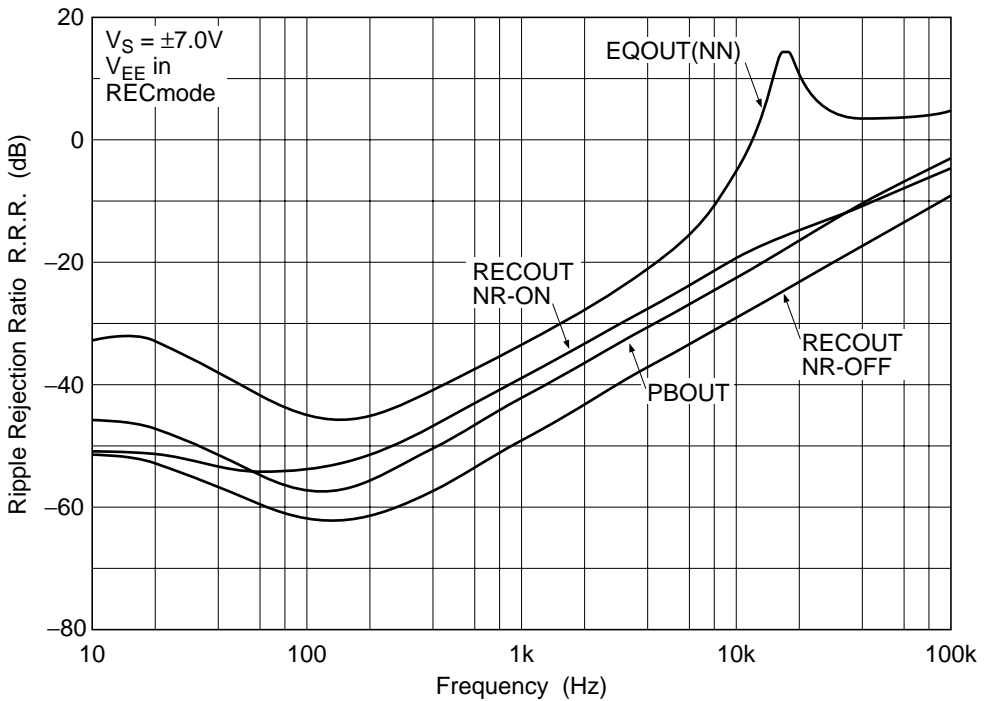

Ripple Rejection Ratio vs. Frequency (PBmode) (1)

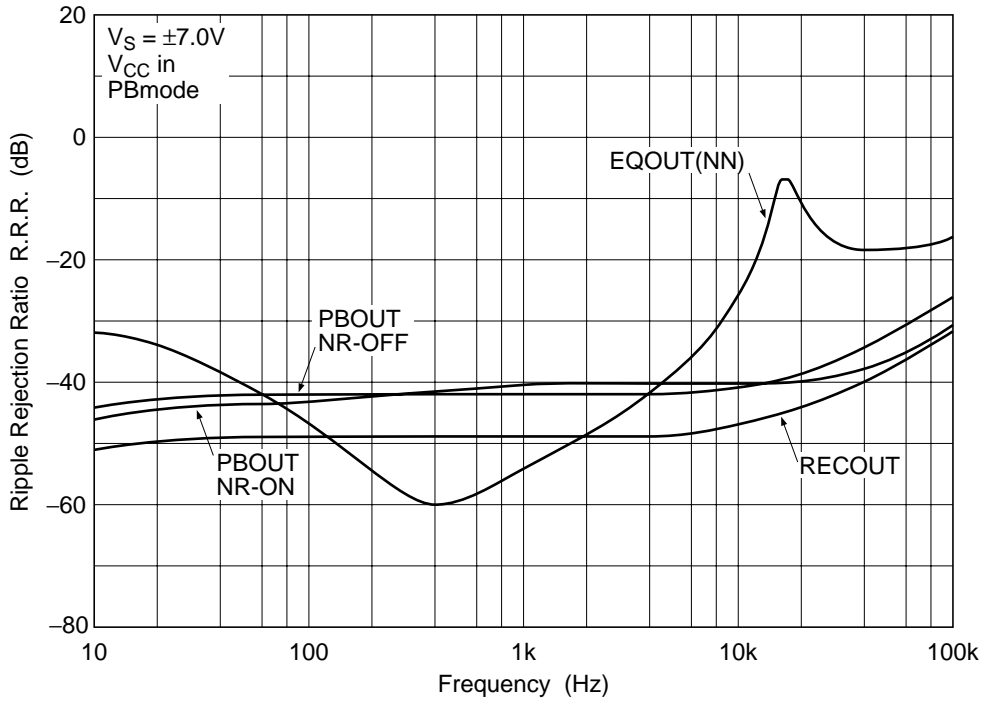

Ripple Rejection Ratio vs. Frequency (PBmode) (2)

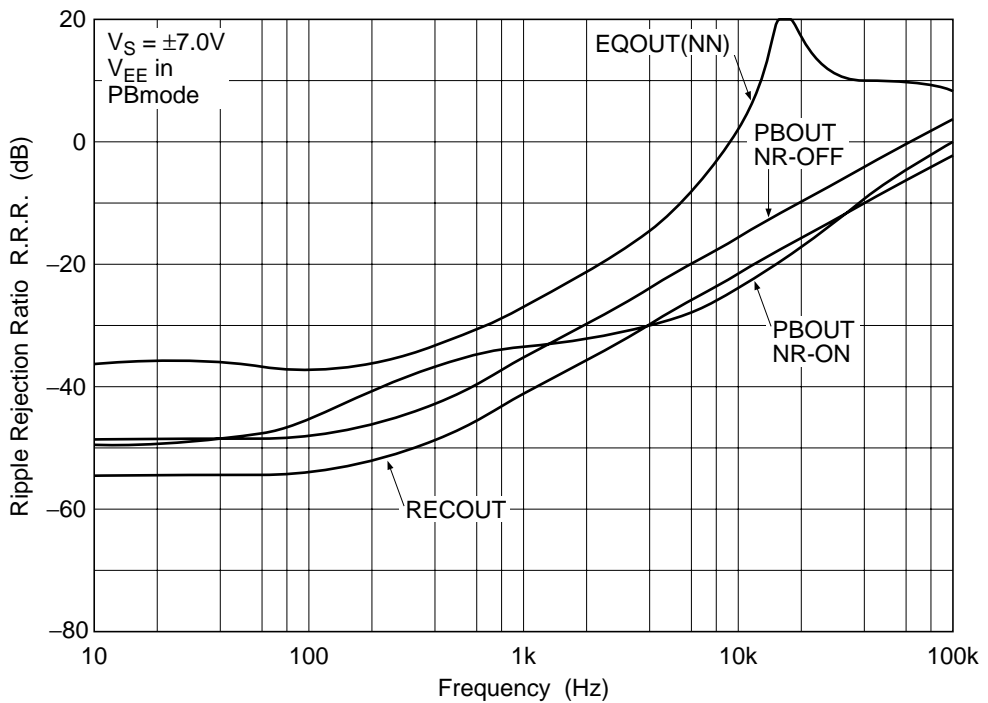

Ripple Rejection Ratio vs. Frequency (PASSmode) (1)

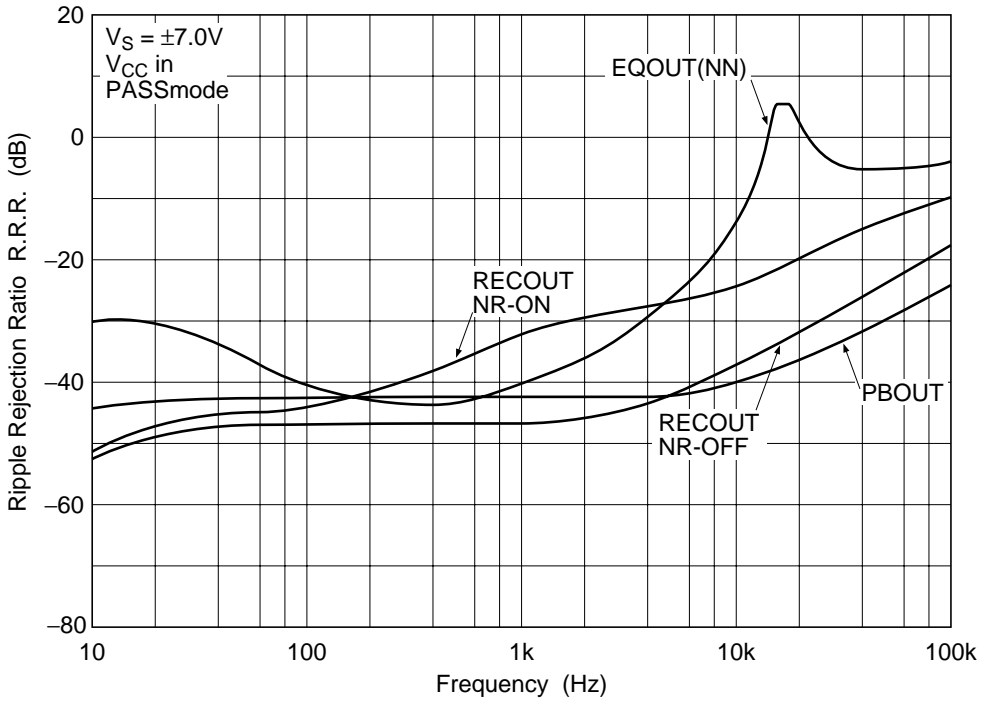

Ripple Rejection Ratio vs. Frequency (PASSmode) (2)

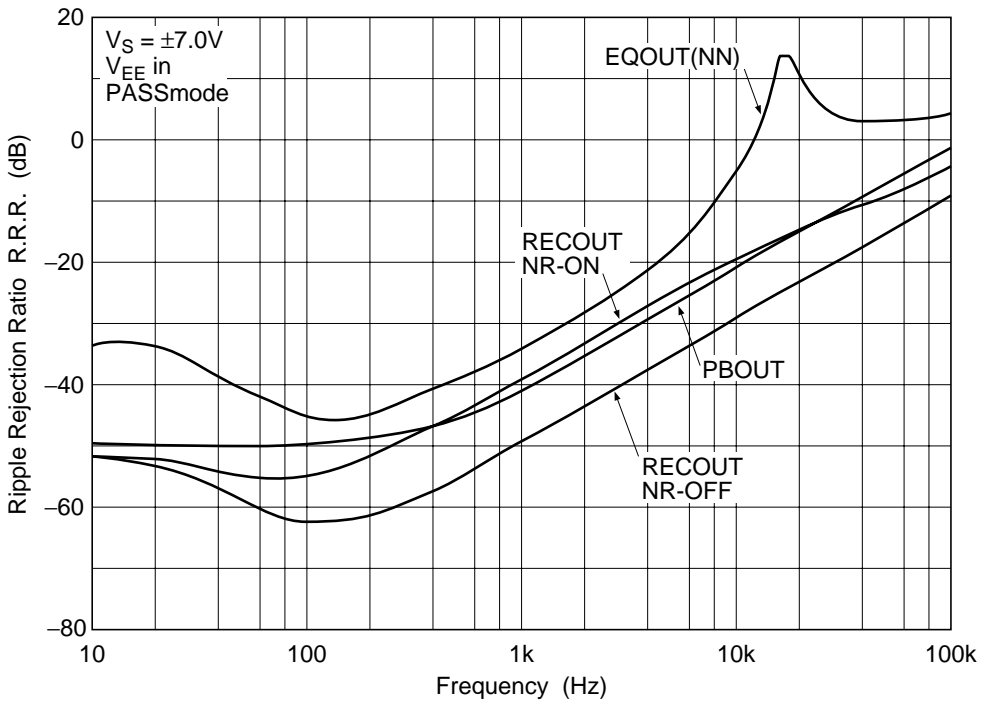

Equalizer Amp. Gain vs. Frequency (1)

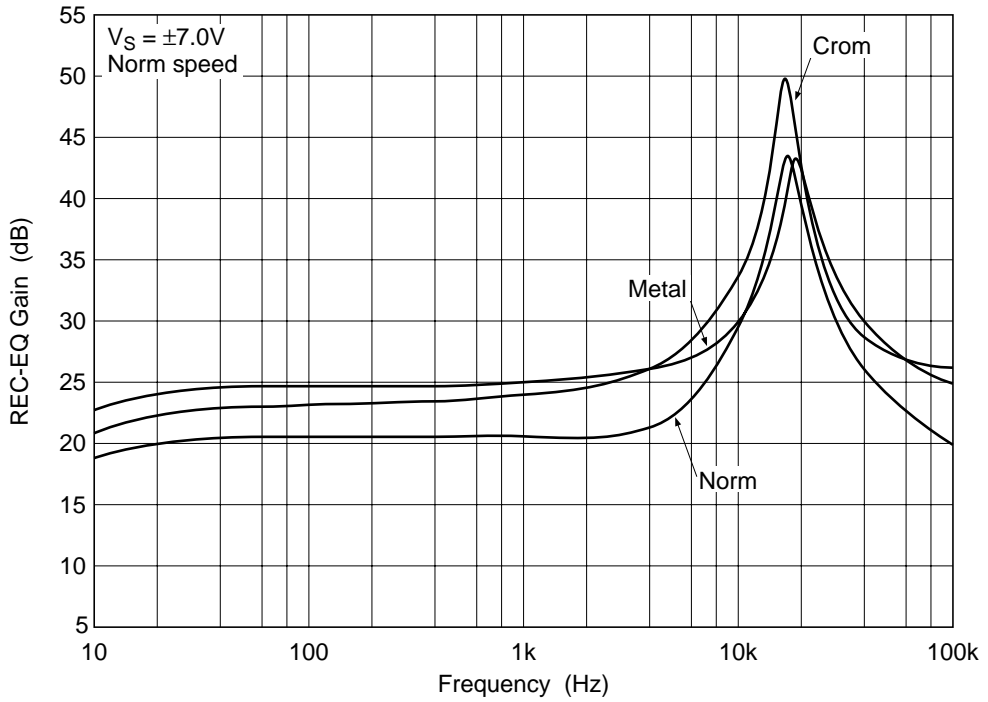

Equalizer Amp. Gain vs. Frequency (2)

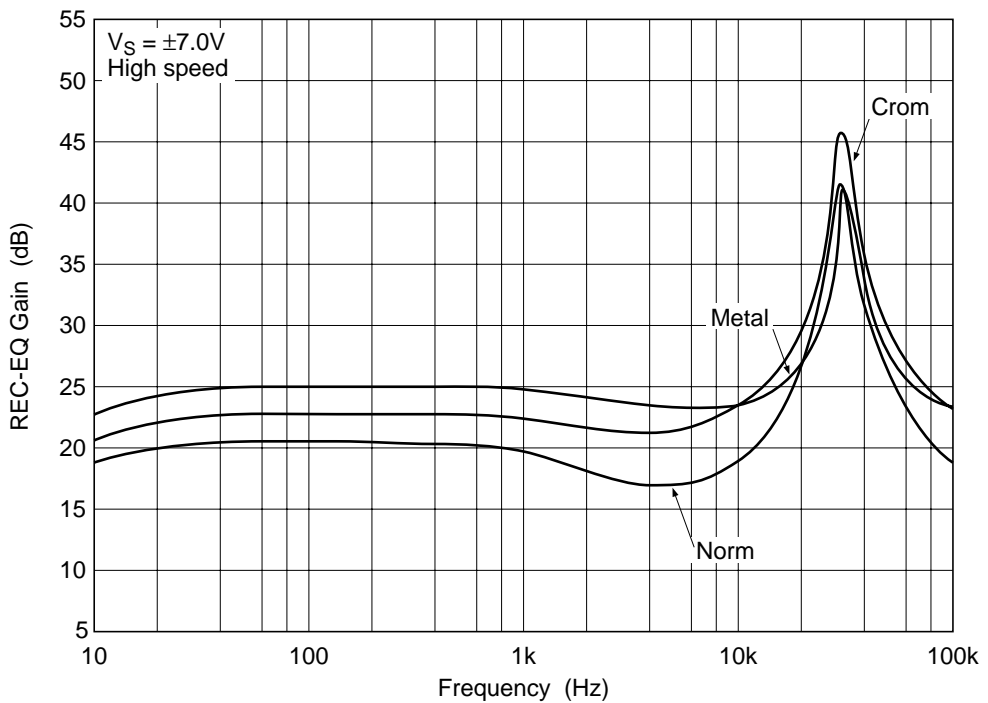

### Equalizer Amp. Gain vs. Frequency (RECcal)

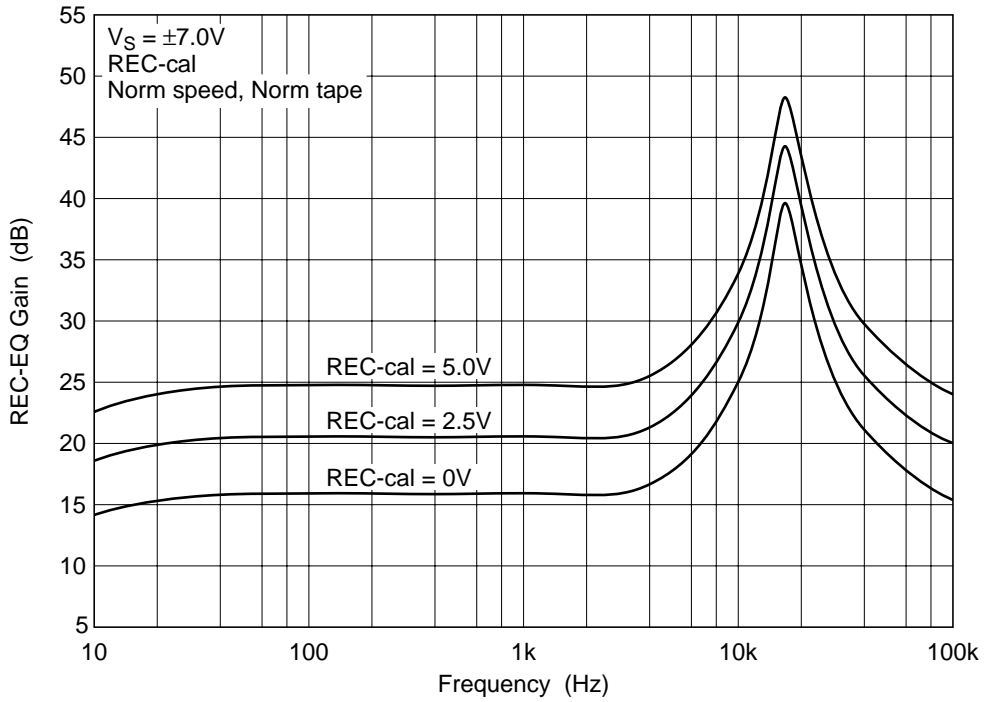

### Equalizer Amp. Gain vs. Frequency (GPcal)

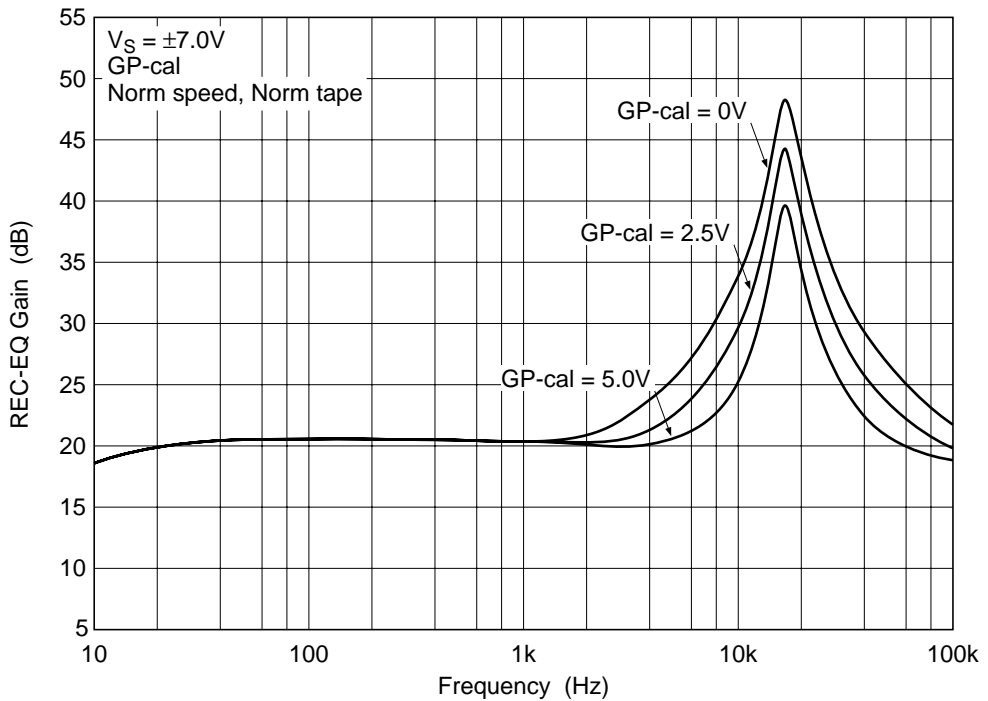



Equalizer Total Harmonic Distortion vs. Output Level (1)

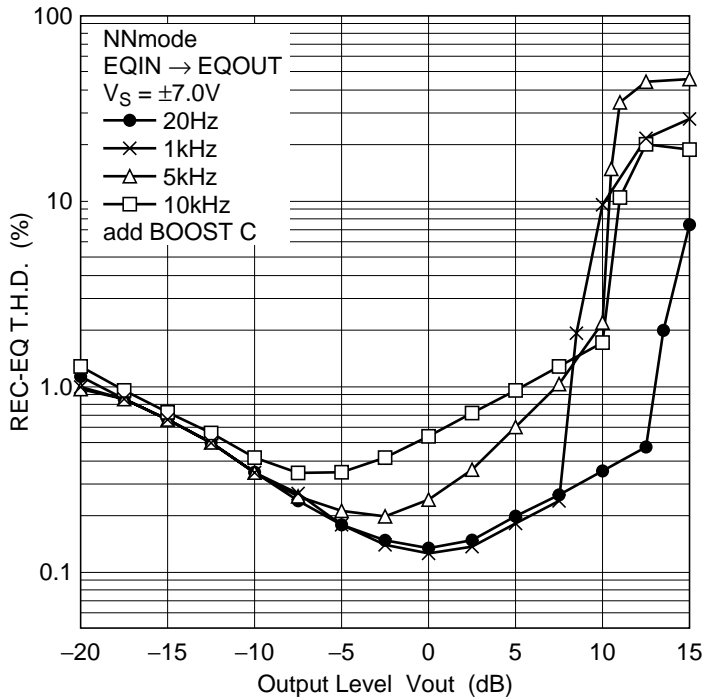

Equalizer Total Harmonic Distortion vs. Output Level (2)

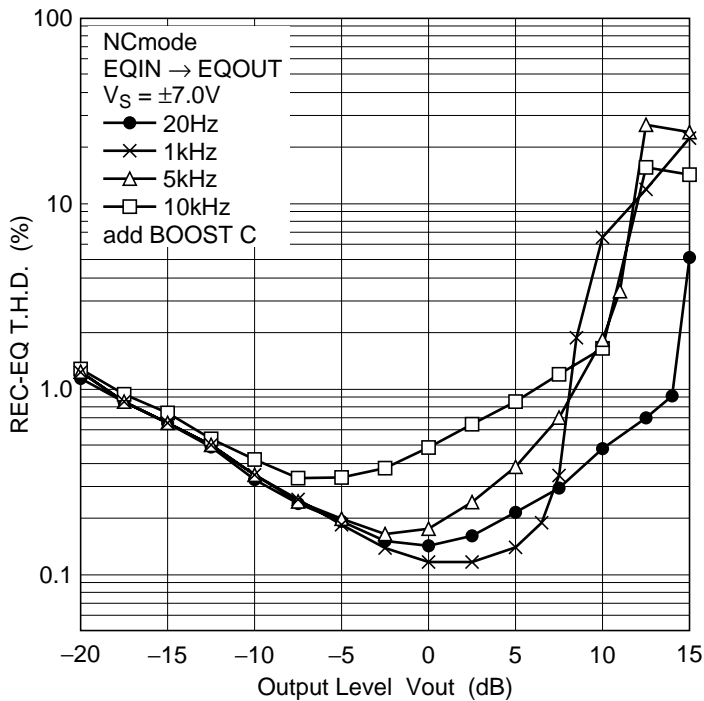

Equalizer Total Harmonic Distortion vs. Output Level (3)

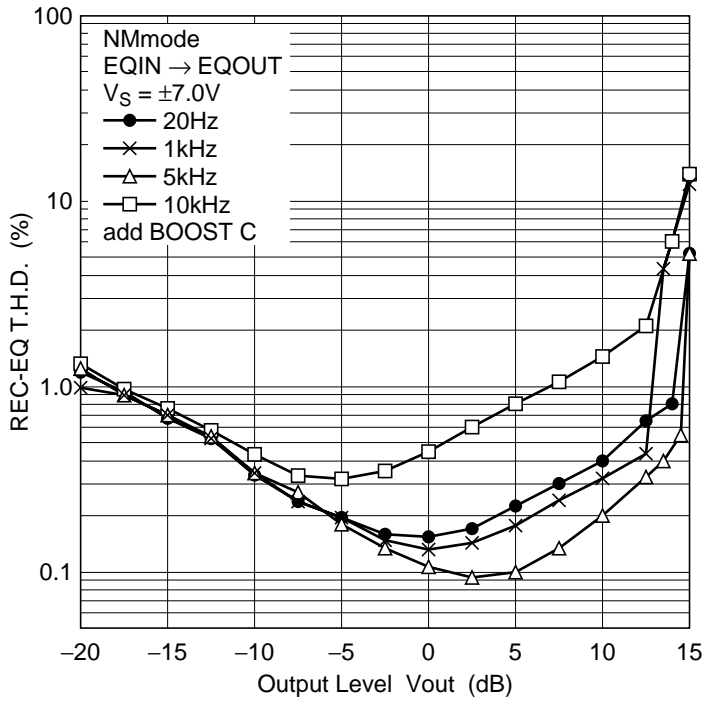

Equalizer Total Harmonic Distortion vs. Output Level (4)

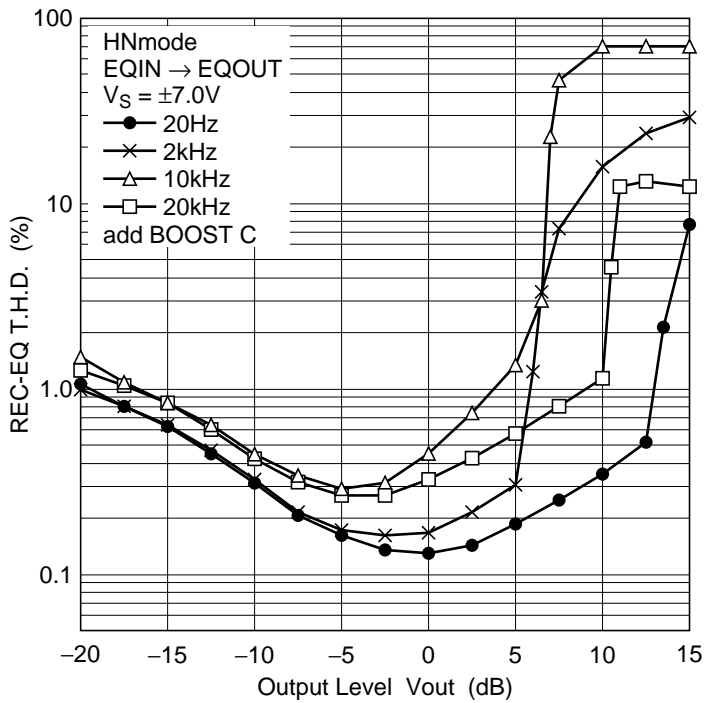

Equalizer Total Harmonic Distortion vs. Output Level (5)

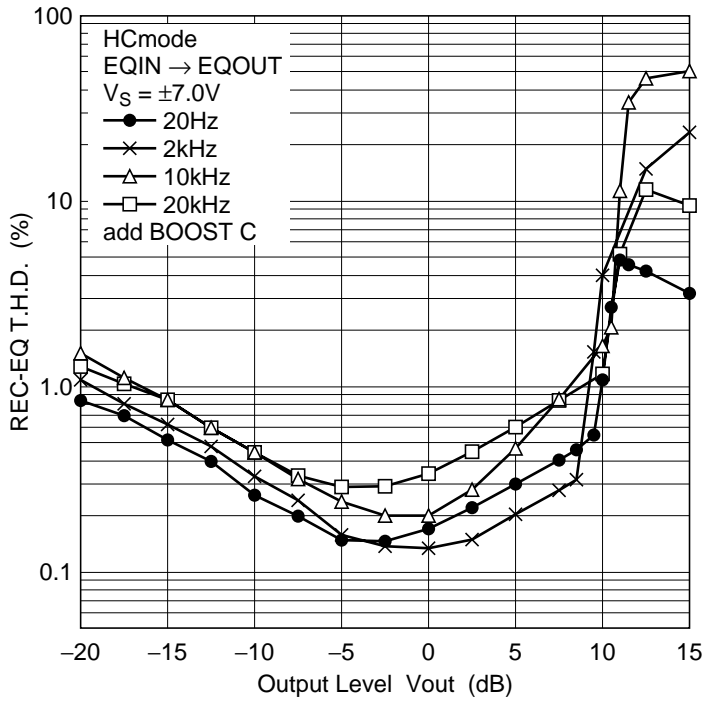

Equalizer Total Harmonic Distortion vs. Output Level (6)

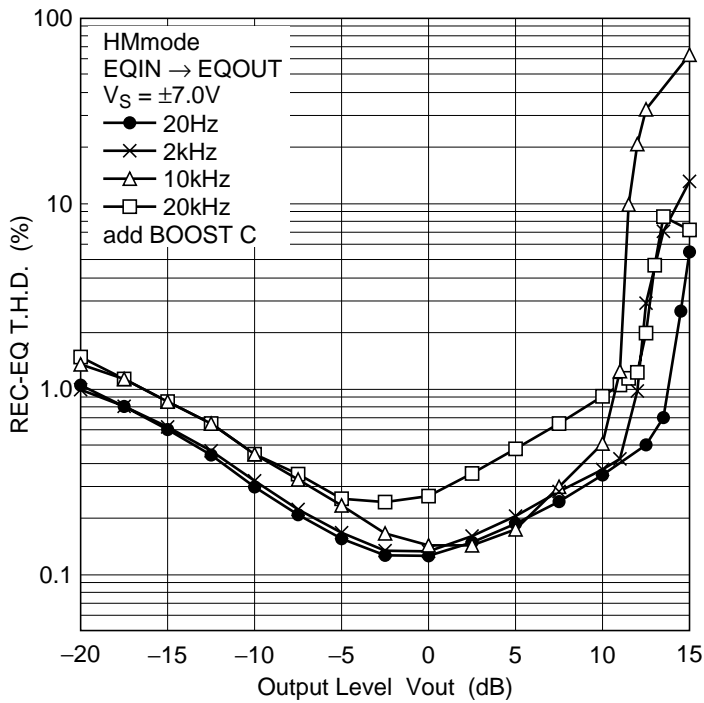

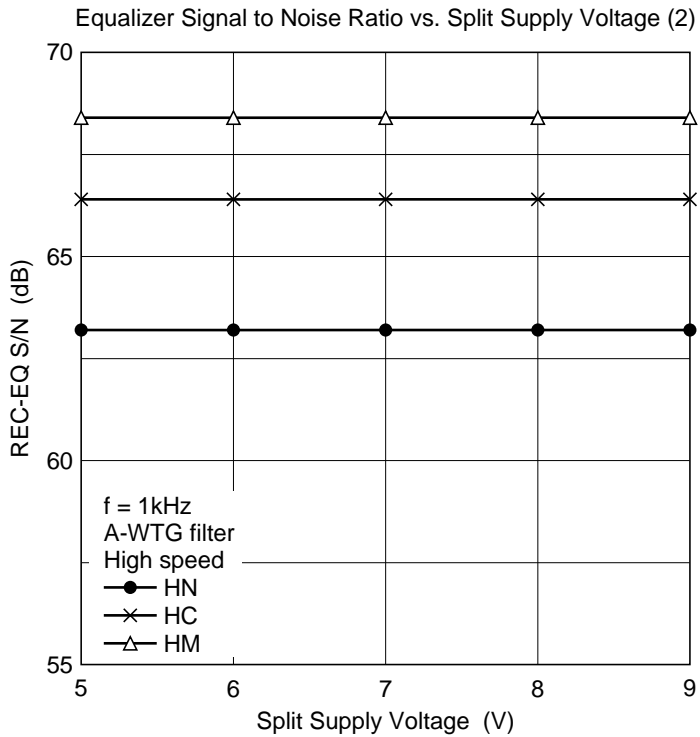
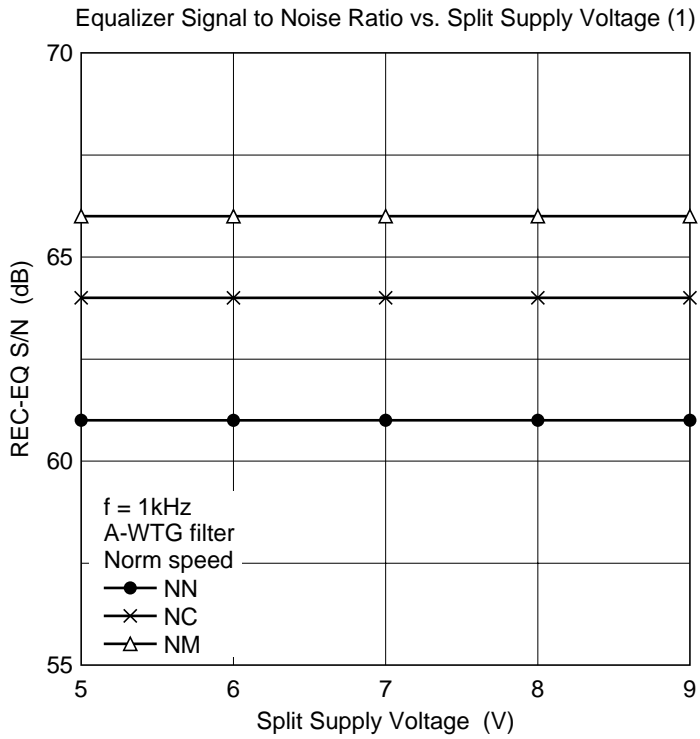

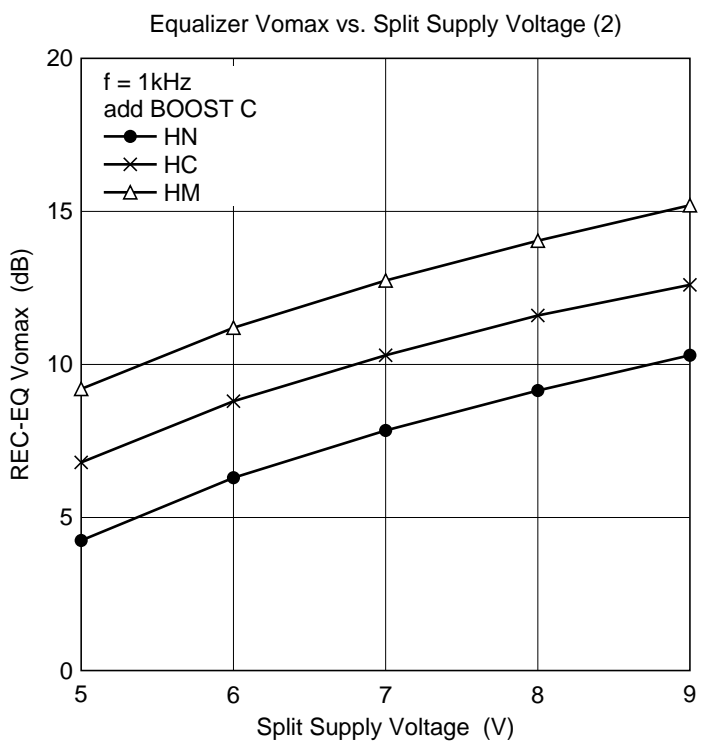
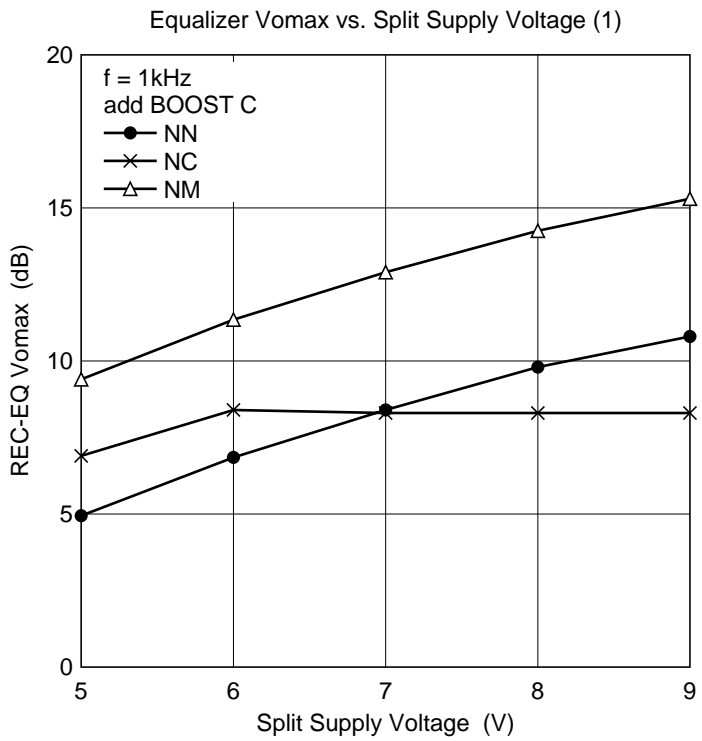

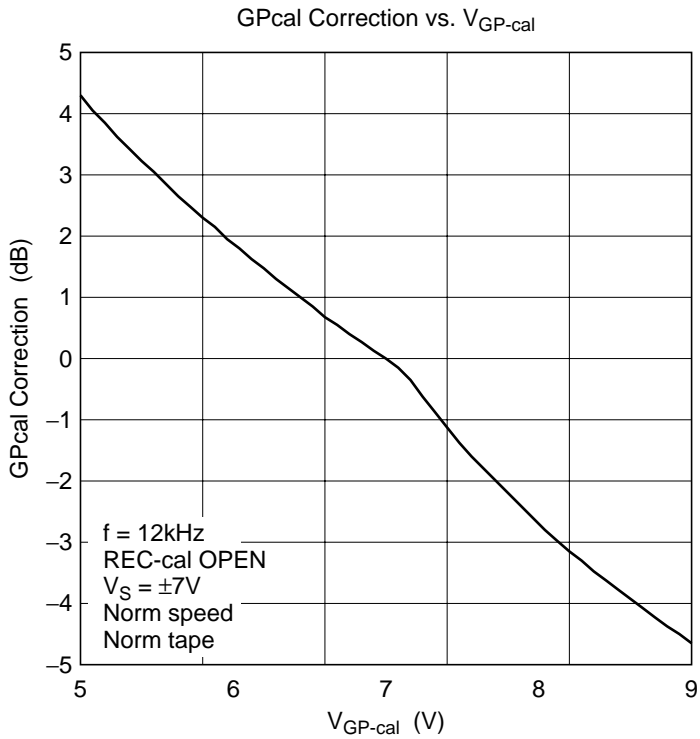
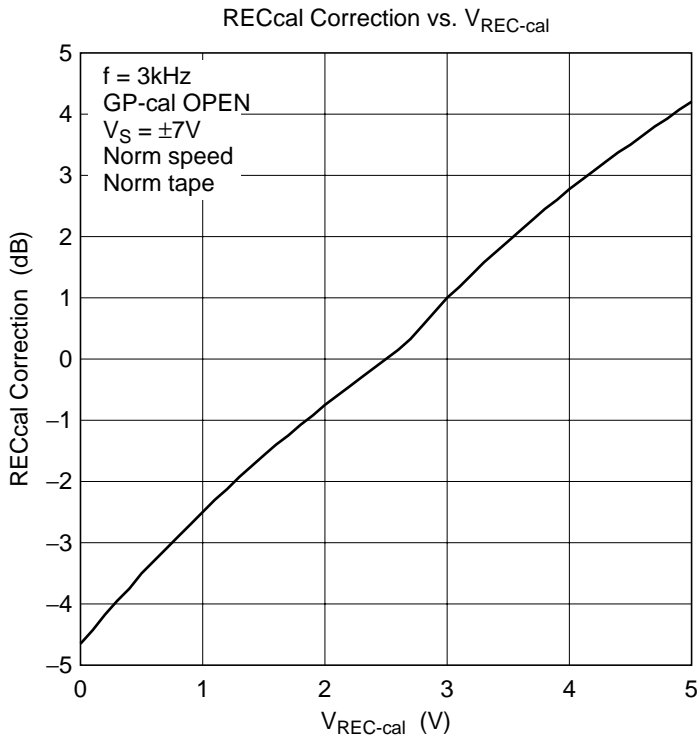

ALC Operate Level vs. Input Level

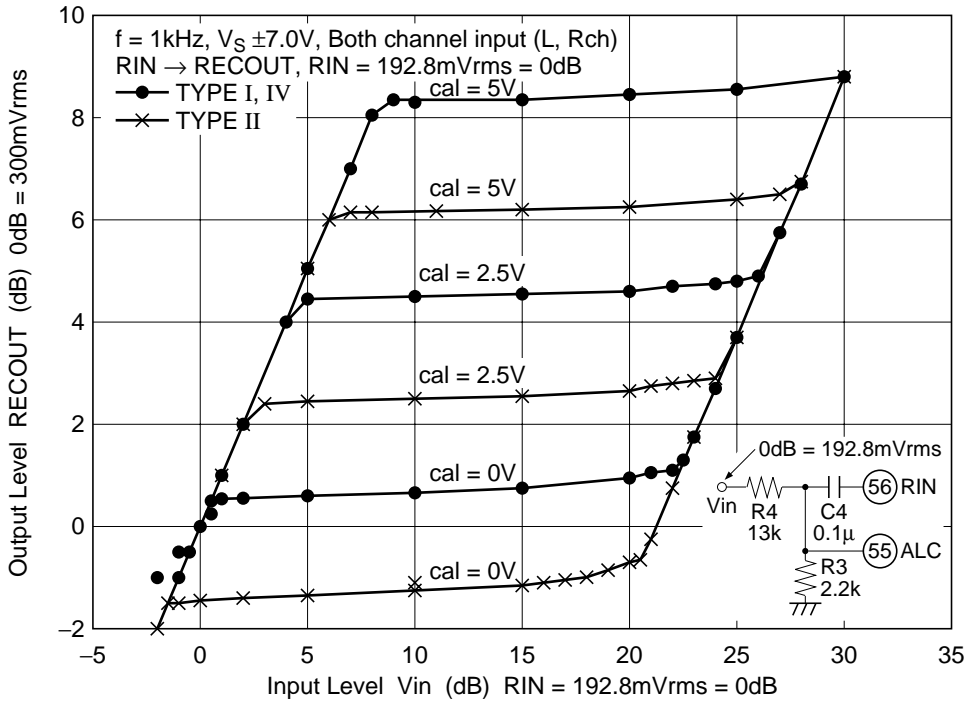

ALC Total Harmonic Distortion vs. Input Level (1)

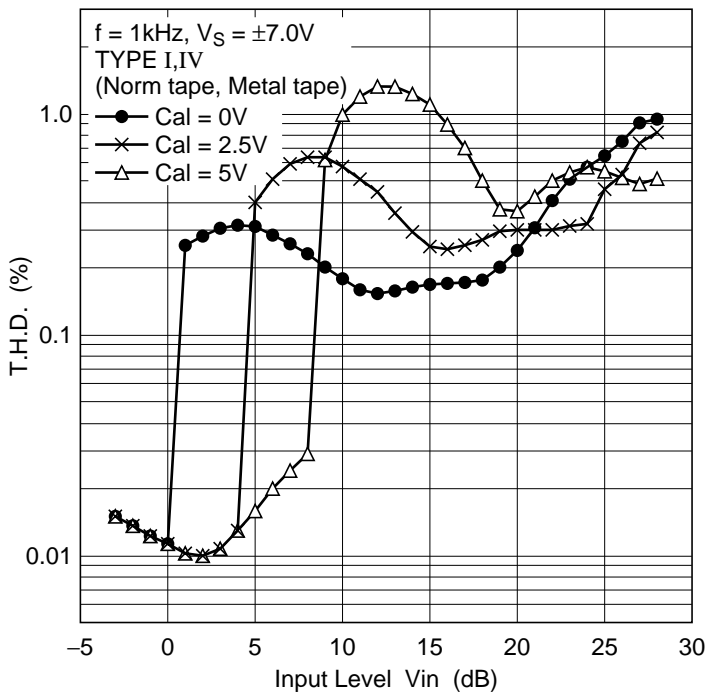

ALC Total Harmonic Distortion vs. Input Level (2)

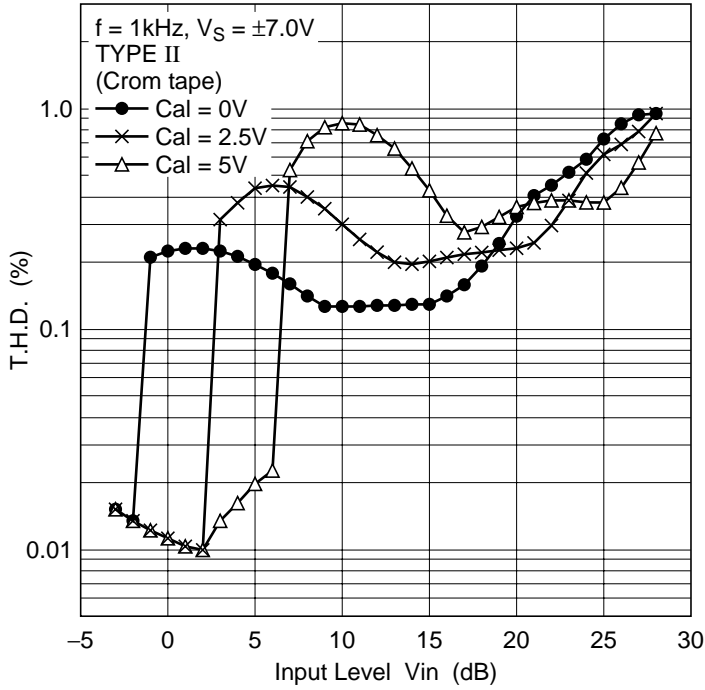

ALC Operate Level vs. Frequency

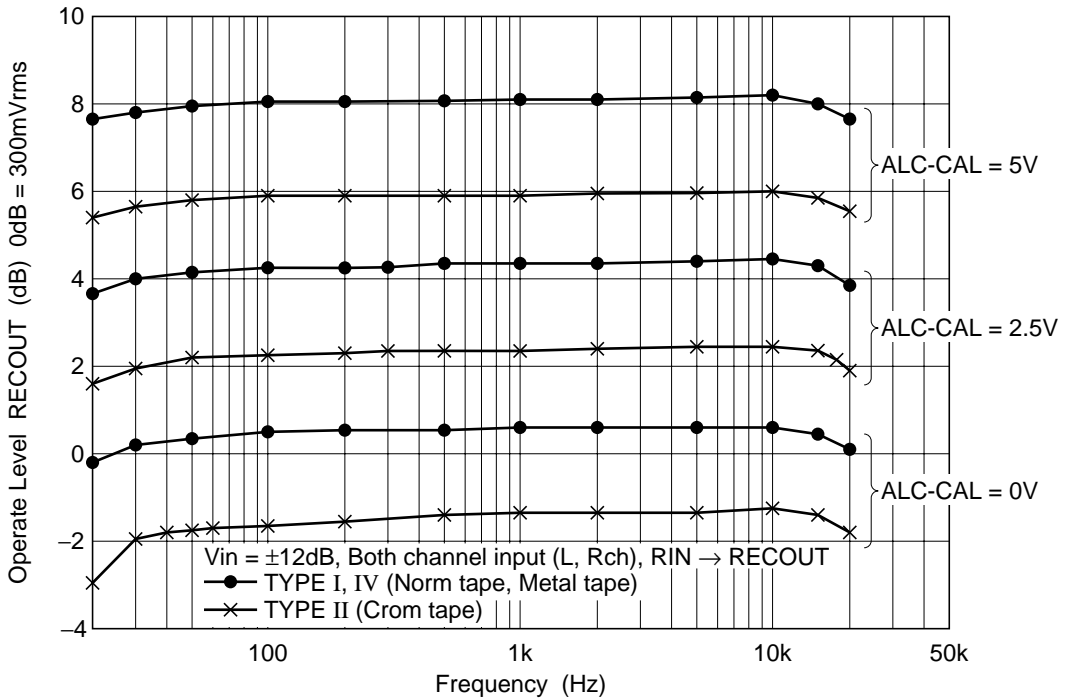



Bias Output Voltage vs. Load Current

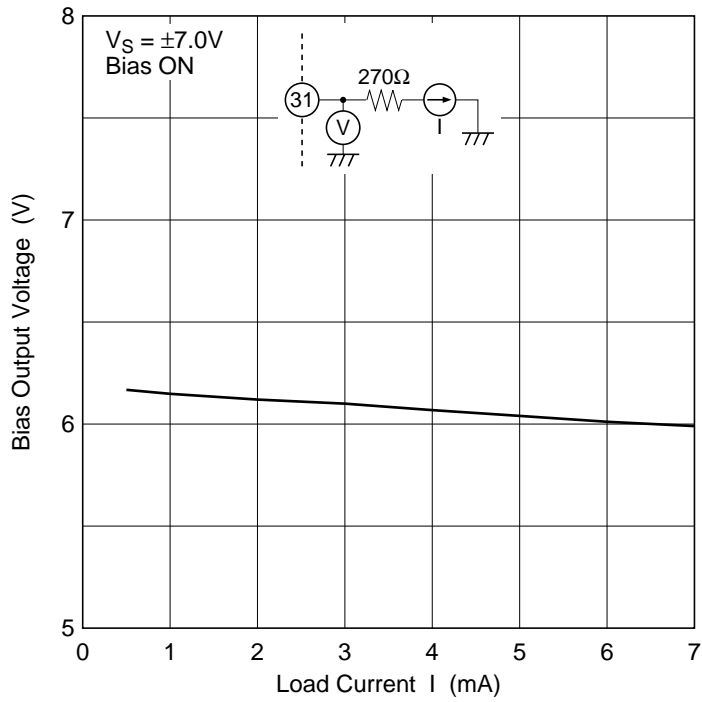

MS Sensing Level vs. Frequency

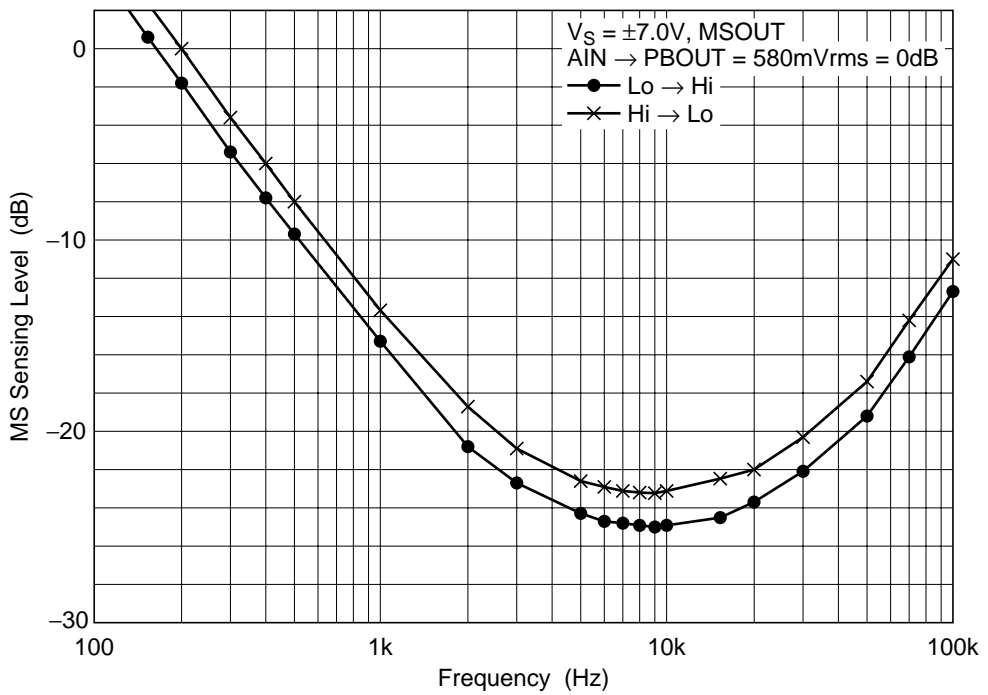

MS Amp. Gain vs. Frequency

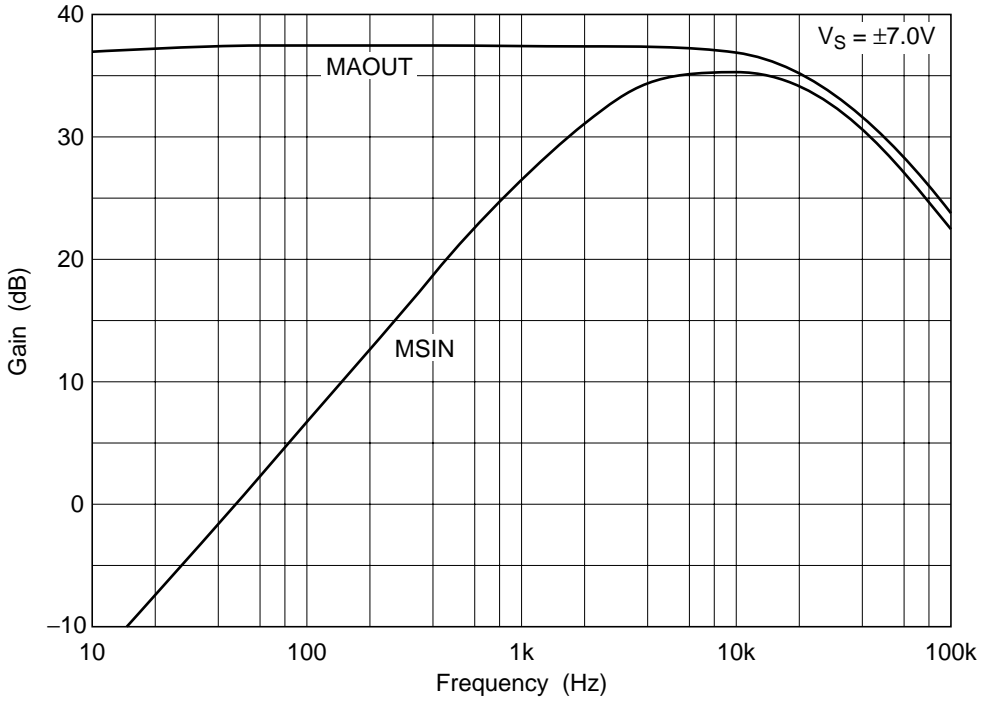

No-Signal Sensing Time vs. Resistance

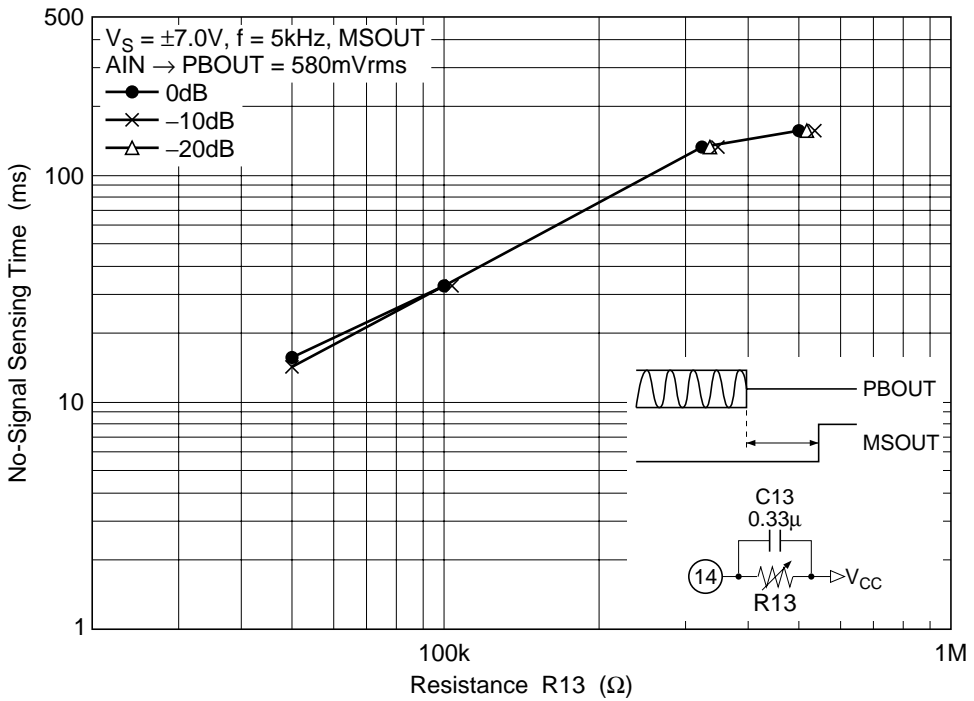

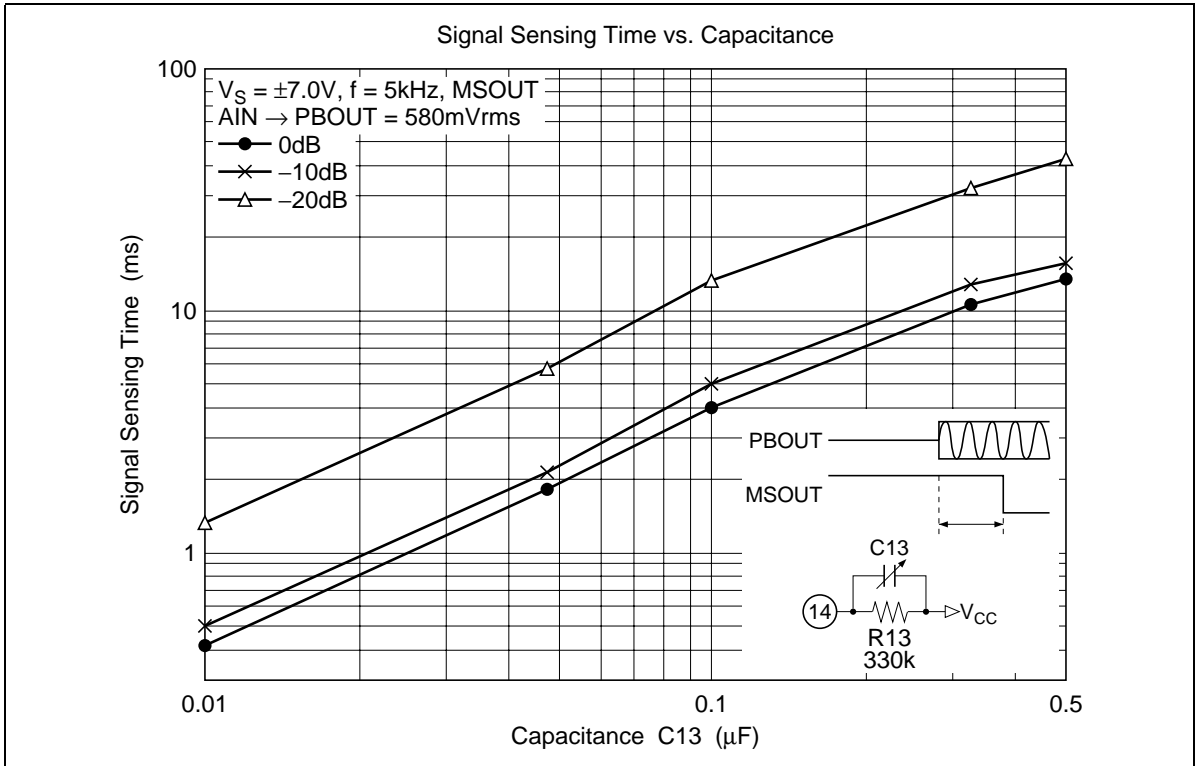

# HA12215F

## Package Dimensions

Unit: mm

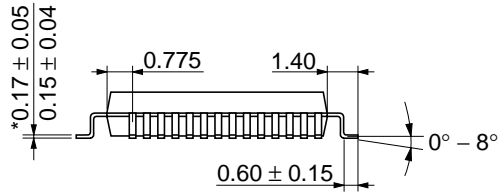
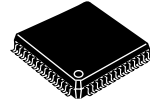
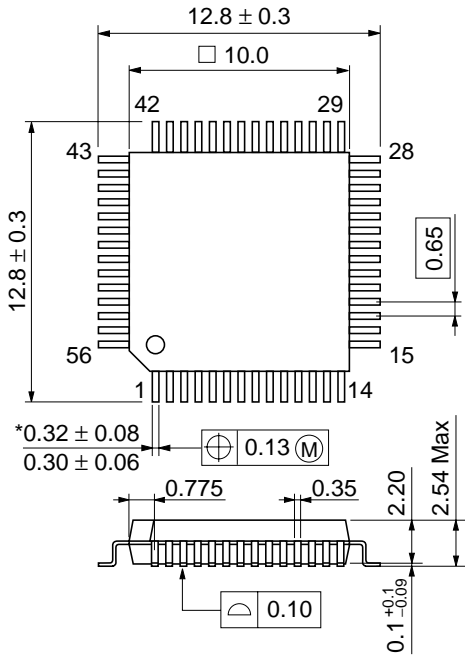

\*Dimension including the plating thickness  
Base material dimension

Hitachi Code	FP-56
JEDEC	—
EIAJ	—
Weight (reference value)	0.5 g

**Disclaimer**

1. Hitachi neither warrants nor grants licenses of any rights of Hitachi's or any third party's patent, copyright, trademark, or other intellectual property rights for information contained in this document. Hitachi bears no responsibility for problems that may arise with third party's rights, including intellectual property rights, in connection with use of the information contained in this document.
2. Products and product specifications may be subject to change without notice. Confirm that you have received the latest product standards or specifications before final design, purchase or use.
3. Hitachi makes every attempt to ensure that its products are of high quality and reliability. However, contact Hitachi's sales office before using the product in an application that demands especially high quality and reliability or where its failure or malfunction may directly threaten human life or cause risk of bodily injury, such as aerospace, aeronautics, nuclear power, combustion control, transportation, traffic, safety equipment or medical equipment for life support.
4. Design your application so that the product is used within the ranges guaranteed by Hitachi particularly for maximum rating, operating supply voltage range, heat radiation characteristics, installation conditions and other characteristics. Hitachi bears no responsibility for failure or damage when used beyond the guaranteed ranges. Even within the guaranteed ranges, consider normally foreseeable failure rates or failure modes in semiconductor devices and employ systemic measures such as fail-safes, so that the equipment incorporating Hitachi product does not cause bodily injury, fire or other consequential damage due to operation of the Hitachi product.
5. This product is not designed to be radiation resistant.
6. No one is permitted to reproduce or duplicate, in any form, the whole or part of this document without written approval from Hitachi.
7. Contact Hitachi's sales office for any questions regarding this document or Hitachi semiconductor products.

**Sales Offices**

**HITACHI**

**Hitachi, Ltd.**

Semiconductor & Integrated Circuits.  
Nippon Bldg., 2-6-2, Ohte-machi, Chiyoda-ku, Tokyo 100-0004, Japan  
Tel: Tokyo (03) 3270-2111 Fax: (03) 3270-5109

URL           NorthAmerica       : <http://semiconductor.hitachi.com/>  
                  Europe                 : <http://www.hitachi-eu.com/hel/ecg>  
                  Asia                      : <http://sicapac.hitachi-asia.com>  
                  Japan                     : <http://www.hitachi.co.jp/Sicd/indx.htm>

**For further information write to:**

Hitachi Semiconductor  
(America) Inc.  
179 East Tasman Drive,  
San Jose, CA 95134  
Tel: <1>(408) 433-1990  
Fax: <1>(408) 433-0223

Hitachi Europe GmbH  
Electronic Components Group  
Dornacher Straße 3  
D-85622 Feldkirchen, Munich  
Germany  
Tel: <49> (89) 9 9180-0  
Fax: <49> (89) 9 29 30 00  
  
Hitachi Europe Ltd.  
Electronic Components Group.  
Whitebrook Park  
Lower Cookham Road  
Maidenhead  
Berkshire SL6 8YA, United Kingdom  
Tel: <44> (1628) 585000  
Fax: <44> (1628) 585160

Hitachi Asia Ltd.  
Hitachi Tower  
16 Collyer Quay #20-00,  
Singapore 049318  
Tel : <65>-538-6533/538-8577  
Fax : <65>-538-6933/538-3877  
URL : <http://www.hitachi.com.sg>

Hitachi Asia Ltd.  
(Taipei Branch Office)  
4/F, No. 167, Tun Hwa North Road,  
Hung-Kuo Building,  
Taipei (105), Taiwan  
Tel : <886>-(2)-2718-3666  
Fax : <886>-(2)-2718-8180  
Telex : 23222 HAS-TP  
URL : <http://www.hitachi.com.tw>

Hitachi Asia (Hong Kong) Ltd.  
Group III (Electronic Components)  
7/F., North Tower,  
World Finance Centre,  
Harbour City, Canton Road  
Tsim Sha Tsui, Kowloon,  
Hong Kong  
Tel : <852>-(2)-735-9218  
Fax : <852>-(2)-730-0281  
URL : <http://www.hitachi.com.hk>

Copyright © Hitachi, Ltd., 2000. All rights reserved. Printed in Japan.  
Colophon 2.0