HA12155NT/HA12157NT

Audio Signal Processor for Cassette Deck (Dolby B/C-type NR
with Recording System)

HITACHI

ADE-207-115C (Z)

4th Edition
June 1997

Description

HA12155NT/HA12157NT is silicon monolithic bipolar IC providing Dolby noise reduction system*, electrical volume system, REC equalizer system and level meter system in one chip.

Functions

- REC equalizer × 2 channel
- Dolby B/C NR × 2 channel
- Electronic volume × 2 channel
- Level Meter × 2 channel

Features

- Inductor less REC equalizer is adjustable of its characteristics by external resistor
- Rec level is adjustable automatically with electrical volume which is built-in
- 3 type of input selection is available (one is by way of electrical volume)
- Separate input selection SW and REC/PB SW
- Dolby noise reduction with dubbing cassette decks
(Unprocessed signal output available from recording out terminals during PB mode)
- Log-compressed level meter output is range from 0 V to 5 V
(Usable as music search switchable gain of 0 dB and 20 dB respectively)
- Normal-speed/high-speed (Double), normal/metal/chrome fully electronic control switching built-in
- NR-ON/OFF, Dolby B/C, MPX ON/OFF fully electronic control switching built-in
(Controllable from micro-controller directly)
- Reduction of number of pin by transfered serial data to electronic volume control switching and another control switching
(Controllable from micro-controller directly)
- Low external parts count

HA12155NT/HA12157NT

* Dolby is a trademark of Dolby Laboratories Licensing Corporation.
A license from Dolby Laboratories Licensing Corporation is required for the use of this IC.

Ordering Information

Type	Package	Dolby Level	REC-OUT Level	PB-OUT Level	Operating voltage	
					Min	Max
HA12155NT	DP-64S	300 mVrms	300 mVrms	580 mVrms	9.5 V	16 V
HA12157NT				775 mVrms	12 V	16 V

Block Diagram

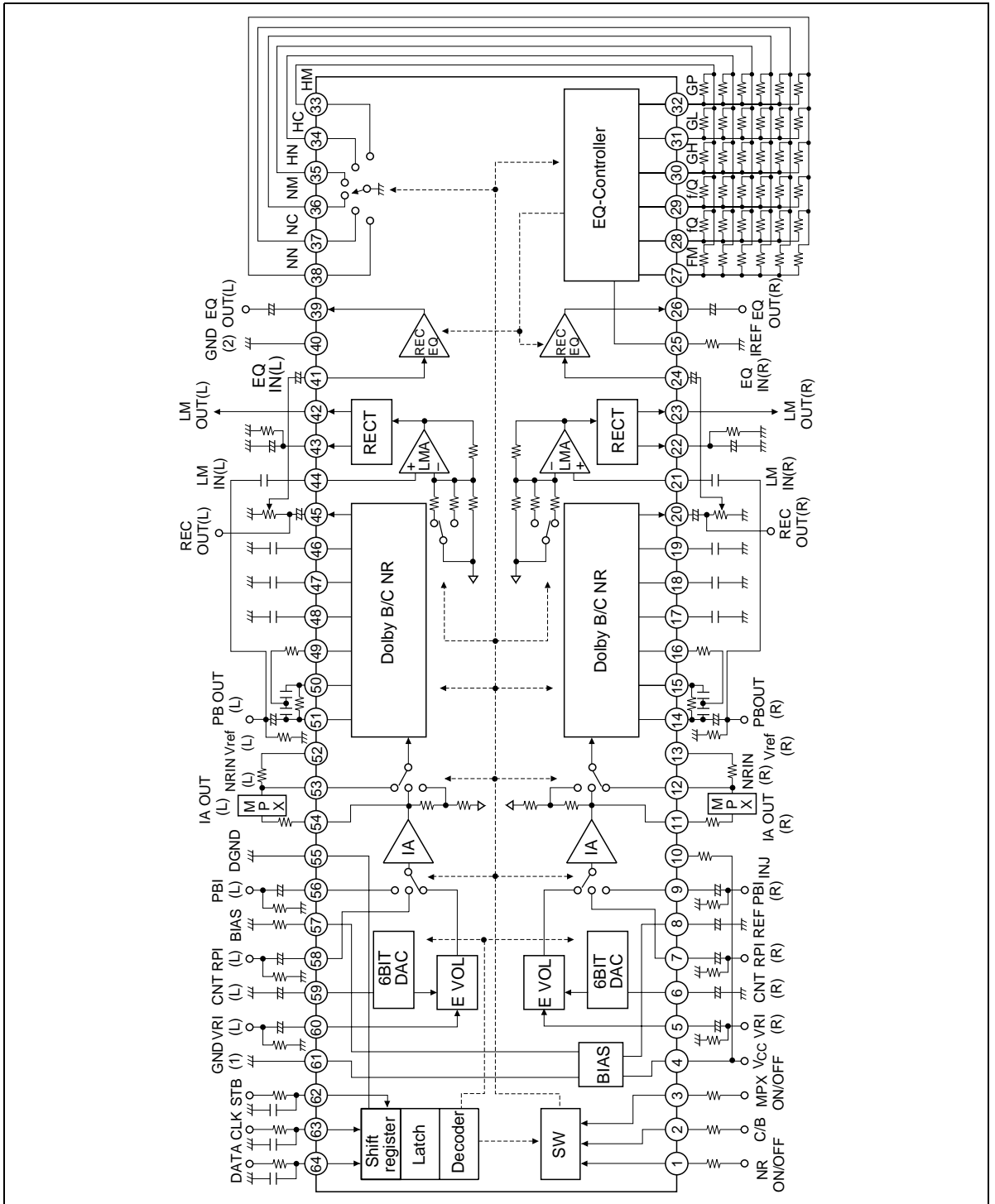

HA12155NT/HA12157NT

Absolute Maximum Ratings

Item	Symbol	Ratings	Unit
Supply voltage	V_{CC}	16	V
Power dissipation*1	P_d	770	mW
Operating temperature	T_{opr}	-30 to +75	°C
Storage temperature	T_{stg}	-55 to +125	°C

Note: 1. Value at $T_a \leq 75^\circ\text{C}$

Electrical Characteristics ($T_a = 25^\circ\text{C}$ $V_{CC} = 14\text{ V}$ Dolby level 300 mVrms)

Item	Symbol	Min	Typ	Max	Unit	Test conditions	Notes
Quiescent current	I_Q	—	29.0	37.0	mA	no signal	
Input amp gain	G_{VIA} RPI	18.5	20.0	21.5	dB	$V_{in} = 0\text{ dB}$, $f = 1\text{ kHz}$	
	G_{VIA} PBI	18.5	20.0	21.5			
B-type NR Encode Boost	B-ENC-2K	2.8	4.3	5.8	dB	$V_{in} = -20\text{ dB}$, $f = 2\text{ kHz}$	
	B-ENC-5K	1.7	3.2	4.7		$V_{in} = -20\text{ dB}$, $f = 5\text{ kHz}$	
C-type NR Encode Boost	C-ENC-1K(1)	3.9	5.9	7.9	dB	$V_{in} = -20\text{ dB}$, $f = 1\text{ kHz}$	
	C-ENC-1K(2)	18.1	19.6	21.6		$V_{in} = -60\text{ dB}$, $f = 1\text{ kHz}$	
	C-ENC-700	9.8	11.8	13.8		$V_{in} = -30\text{ dB}$, $f = 700\text{ Hz}$	
Signal handling	V_{omax}	12.0	13.0	—	dB	$f = 1\text{ kHz}$, THD = 1%, $V_{CC} = 12\text{ V}$	*1
Signal to noise ratio	S/N	60.0	63.0	—	dB	$R_g = 5.1\text{ k}\Omega$, CCIR/ARM	
Total harmonic distortion	THD	—	0.08	0.3	%	$V_{in} = 0\text{ dB}$, $f = 1\text{ kHz}$	
Crosstalk	C_T (R \leftrightarrow L)	—	-85.0	-79.0	dB	$V_{in} = 0\text{ dB}$, $f = 1\text{ kHz}$	
	C_T (RPI \leftrightarrow PBI)	—	-80.0	-74.0			
	C_T (VRI \leftrightarrow RPI)	—	-77.0	-71.0			
Control voltage	Hi level	V_{cH}	3.5	—	5.3	V	MPX ON/OFF, NR
	Lo level	V_{cL}	-0.2	—	1.0		
Serial data voltage	Hi level	V_{sH}	3.5	—	5.3	V	CLK, DATA, STB
	Lo level	V_{sL}	-0.2	—	1.0		
PB-out level	HA12155	V_{out}	500	580	670	mVrms	$V_{in} = 0\text{ dB}$, $f = 1\text{ kHz}$
	HA12157		665	775	900		
PB-offset	V_{ofs}	-100	0.0	+100	mV	no signal	
Channel balance	ΔG_V	-1.0	0.0	1.0	dB	$V_{in} = 0\text{ dB}$, $f = 1\text{ kHz}$	
Volume gain	$G_{VVR(MAX)}$	17.5	19.3	21.5	dB	$V_{in} = 100\text{ mVrms}$, $f = 1\text{ kHz}$	
	$G_{VVR(MIN)}$	—	—	-55.0		$V_{in} = 3\text{ Vrms}$, $f = 1\text{ kHz}$	

Electrical Characteristics ($T_a = 25^\circ\text{C}$ $V_{cc} = 14\text{ V}$ Dolby level 300 mVrms) (cont)

Item	Symbol	Min	Typ	Max	Unit	Test conditions	Notes
Volume mute	$G_{VVR(MUT)}$	—	—	-80.0	dB	$V_{in} = 3\text{ Vrms}$, $f = 1\text{ kHz}$	
Max-input level to volume	$V_{in\ max}\ (VR)$	11.0	12.6	—	dBs	$f = 1\text{ kHz}$, THD = 1%, $V_{cc} = 12\text{ V}$	
Volume S/N	S/N (VR)	78.0	84.0	—	dB	$V_{in} = 100\text{ mVrms}$, $f = 1\text{ kHz}$, A-WTG	
Volume THD	THD (VR)	—	0.04	0.3	%	$V_{in} = 100\text{ mVrms}$, $f = 1\text{ kHz}$	
Equalizer gain	$G_{VEQ(500)}$	13.0	15.0	17.0	dB	$V_{in} = 77.5\text{ mVrms}$, $f = 500\text{ Hz}$	
	$G_{VEQ(1K)}$	13.0	15.0	17.0		$V_{in} = 77.5\text{ mVrms}$, $f = 1\text{ kHz}$	
	$G_{VEQ(5K)}$	14.5	16.5	18.5		$V_{in} = 77.5\text{ mVrms}$, $f = 5\text{ kHz}$	
	$G_{VEQ(10K)}$	18.5	20.5	22.5		$V_{in} = 77.5\text{ mVrms}$, $f = 10\text{ kHz}$	
	$G_{VEQ(20K)}$	29.5	32.0	34.5		$V_{in} = 77.5\text{ mVrms}$, $f = 20\text{ kHz}$	
Equalizer maximum input	$V_{in\ max}\ (EQ)$	-8.0	-7.0	—	dBs	$f = 1\text{ kHz}$, THD = 1%, $V_{cc} = 12\text{ V}$	*1
Equalizer S/N	S/N (EQ)	57.0	62.0	—	dB	$R_g = 5.1\text{ k}\Omega$, A-WTG	
Equalizer THD	THD (EQ)	—	0.2	0.5	%	$V_{in} = 77.5\text{ mVrms}$, $f = 1\text{ kHz}$	
Equalizer offset	Vofs (EQ)	-400	0.0	+400	mV	no signal	
Level meter output	LM (0 dB)	2.60	2.85	3.10	V	$V_{in} = 0\text{ dB}$, $f = 1\text{ kHz}$	*2
	LM (12 dB)	3.60	3.90	4.20	V	$V_{in} = 12\text{ dB}$, $f = 1\text{ kHz}$	
Level meter output	LM (-20 dB)1	0.80	1.10	1.40	V	$V_{in} = -20\text{ dB}$, $f = 1\text{ kHz}$	*2
	LM (-20 dB)2	2.55	3.0	3.15	V	$V_{in} = -20\text{ dB}$, $f = 1\text{ kHz}$, -20 dB range	
Level meter offset	LMofs 1	—	150	300	mV	no signal	
	LMofs 2	—	200	350		no signal, -20 dB range	

 Notes: 1. HA12155 $V_{cc} = 9.5\text{ V}$, HA12157 $V_{cc} = 12\text{ V}$

2. 0 dB = PB-OUT level

Pin Description ($V_{CC} = 14\text{ V}$, $T_a = 25^\circ\text{C}$, No signal, the value in the table show typical value)

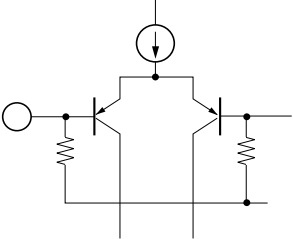
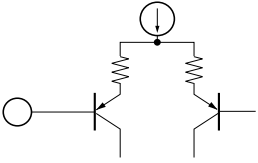
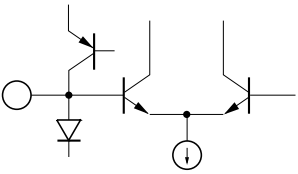
Pin No.	Terminal	DC	Equivalent circuit	Description
7	RPI	$100\text{ k}\Omega$	$V_{CC}/2$	Recording input
58				
9	PBI			Play back input
56				
21	LM IN	HA12155 ---75 k Ω		Level meter input
44		HA12157 ---100 k Ω		
24	EQ IN	100 k Ω		Equalyzer input
41				
5	VRI	100 k Ω	$V_{CC}/2$	Volume input
60			+0.7 V	
4	V_{CC}	—	V_{CC}	Power supply
8	REF	—	$V_{CC}/2$	Ripple filter
12	NR IN	—	$V_{CC}/2$	NR processor input
53				
15	SS 1	—	$V_{CC}/2$	Spectral skewing amp input
50				

HA12155NT/HA12157NT

Pin Description ($V_{CC} = 14\text{ V}$, $T_a = 25^\circ\text{C}$, No signal, the value in the table show typical value) (cont)

Pin No.	Terminal	DC	Equivalent circuit	Description
DP-64S	name	Zin	voltage	
17	CCR	—	$V_{CC}/2$	Current controlled resistor output
48				
11	IA OUT	—	$V_{CC}/2$	Input amp output
54				
13	VREF			Reference voltage
52				buffer output
14	PB OUT			Play back (Decode) output
51				output
16	SS 2			Spectral skewing amp. output
49				amp. output
20	REC OUT			Recording (Encode) output
45				output
26	EQ OUT			Equalizer output
39				

Pin Description ($V_{CC} = 14\text{ V}$, $T_a = 25^\circ\text{C}$, No signal, the value in the table show typical value) (cont)

Pin No.	Terminal	DC	Equivalent circuit	Description
DP-64S	name	Zin	voltage	
18 47	HLS DET	—	2.3 V	Time constant pin for rectifier
19 46	LLS DET			
57	BIAS	—	0.28 V	Dolby NR Reference current input
25	IREF	—	1.2 V	EQ Reference current input
27	FM			EQ Parameter current
28	fQ			input
29	f/Q			
30	GH			
31	GL			
32	GP			

HA12155NT/HA12157NT

Pin Description ($V_{CC} = 14\text{ V}$, $T_a = 25^\circ\text{C}$, No signal, the value in the table show typical value) (cont)

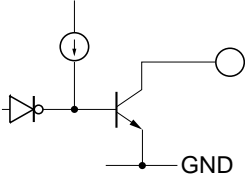
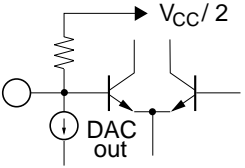
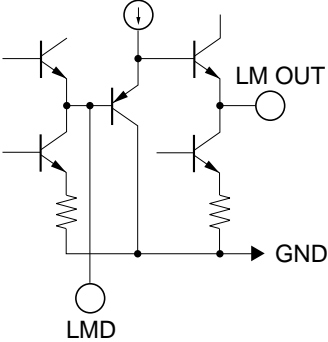
Pin No.	Terminal name	Zin	DC voltage	Equivalent circuit	Description
33	HM	—	—		EQ Parameter selector
34	HC				
35	HN				
36	NM				
37	NC				
38	NN				
6	CNT	5.2 kΩ	$V_{CC}/2$ - 1.5 V to $V_{CC}/2$		DAC output Volume control input
22	LMD	—	0.2 V		Time constant Pin for level meter
43					
23	LM OUT	—	0.2 V		Level meter output
42					

Pin Description ($V_{CC} = 14\text{ V}$, $T_a = 25^\circ\text{C}$, No signal, the value in the table show typical value) (cont)

Pin No.	Terminal name	Zin	DC voltage	Equivalent circuit	Description
1	NR ON/OFF	100 k Ω	—		Mode control input
2	C/B				
3	MPX ON/OFF				
62	STB				
63	CLK				
64	DATA				
10	INJ	—	0.7 V	—	Injection current input for I ² L
55	D-GND	—	0.0 V	—	Digital (Logic) ground
40	GND	—	0.0 V	—	Ground
61					

Application Note

Power Supply Range

HA12155NT/HA12157NT are designed to operate on either single supply or split supply.

The operating range of the supply voltage is shown in table 1.

Table 1 Supply Voltage

Type No.	Single supply	Split supply
HA12155NT	9.5 V to 16 V	$\pm 6\text{ V}$ to 8 V
HA12157NT	12 V to 16 V	$\pm 6\text{ V}$ to 8 V

The lower limit of supply voltage depends on the line output reference level.

HA12155NT/HA12157NT

The minimum value of the headroom margin is specified as 12 dB by Dolby Laboratories. HA12155 series are provided with two line output level, which will permit an optimum headroom margin for power supply conditions.

Reference Voltage

For the single supply operation these devices provide the reference voltage of half the supply voltage that is the signal grounds. As the peculiarity of these devices, the capacitor for the ripple filter is very small about 1/100 compared with their usual value. The Reference voltage are provided for the left channel and the right channel separately. The block diagram is shown as figure 1.

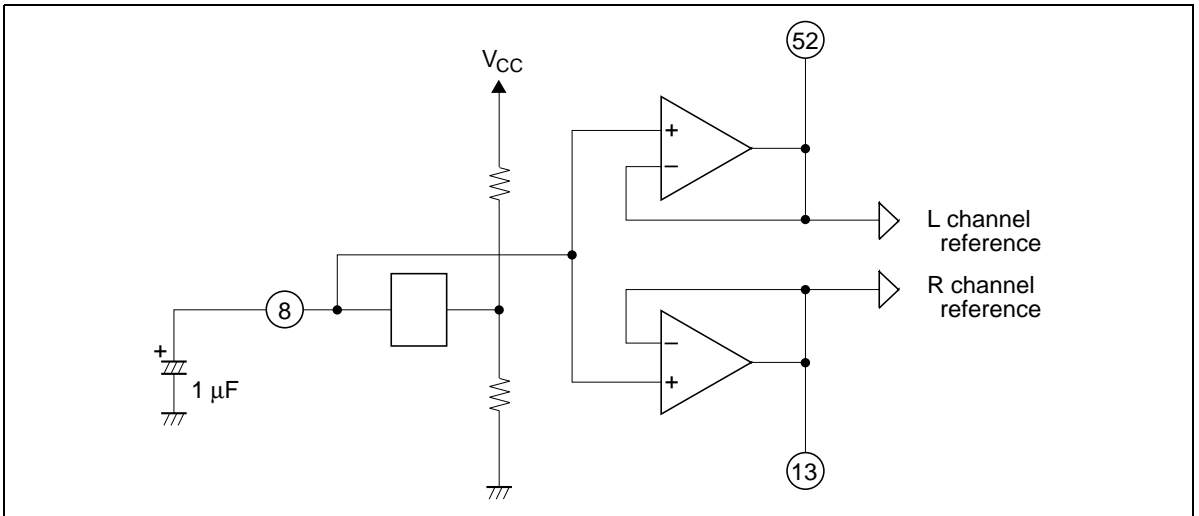

Figure 1 The Block Diagram of Reference Voltage Supply

Operating Mode Control

HA12155NT/HA12157NT provides fully electronic switching circuits. NR-ON/OFF, C/B, and MPX ON/OFF switches are controlled by parallel data (DC voltage) and other switches are controlled by serial data.

Table 2 Threshold Voltage (V_{TH})

Pin No.	Lo	Hi	Unit
1, 2, 3	-0.2 to 1.0	3.5 to 5.3	V
62, 63, 64	-0.2 to 1.0	3.5 to 5.3	V

Notes: 1. Voltages shown above are determined by internal circuits of LSI when take pin 55 (DGND pin) as reference pin. On split supply use, same V_{TH} can be offered by connecting DGND pin to GND pin.

This means that it can be controlled directly by micro processor.

2. Each pins are on pulled down with 100 k Ω internal resistor.

Therefore, it will be low-level when each pins ar open.

3. Note on serial data inputting

(a) The clock frequency on CLK must be less than 500 kHz.

(b) Over shoot level and under shoot level of input signal must be the value shown below.

(c) The serial input pins (pins 62, 63, and 64) are extremely sensitive to undershoot, overshoot, ringing, and noise. This can result in malfunctions due to problems with the wiring pattern. We recommend attaching capacitors in parallel with the serial input pins to ameliorate this problem.

Figure 2-b shows an example of this circuit appropriate when the clock frequency is 500 kHz. The value of the capacitor should be set in accordance with the clock frequency actually used.

4. NR Mode Switching

In actual use, pop noises may accompany NR on/off switching in C mode. To avoid these noises, use the following sequences to turn NR on and off.

From C mode NR off to C mode NR on:

(C mode, NR off) \rightarrow (B mode, NR off) \rightarrow (B mode, NR on) \rightarrow (C mode, NR on).

From C mode NR on to C mode NR off:

(C mode, NR on) \rightarrow (B mode, NR on) \rightarrow (B mode, NR off) \rightarrow (C mode, NR off).

Table 3 Switching Truth Table

Pin No.	Lo	Hi
1	NR-OFF	NR-ON
2	B-NR	C-NR
3	MPX-ON	MPX-OFF

Notes: 1. Low level will be offered when each pins are open.

2. Please refer to next term as for the serial data for formatting.

When connecting microcomputer or Logic-IC with HA12155NT/HA12157NT directly, there is apprehension of rash-current under some transition timming of raising voltage or falling voltage at V_{CC} ON/OFF.

For this countermeasure, connect 10 k Ω to 20 k Ω resistor with each pins. It is shown in test circuit.

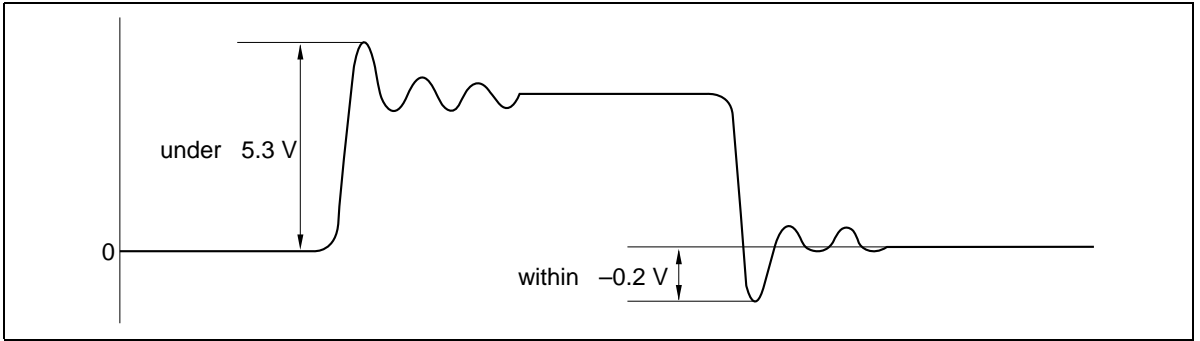

Figure 2 Input Level

Serial Data Formatting

8 bit shift register is employed. CLK and DATA are stored during STB being high and data is latched when STB goes high to low. The clock frequency on CLK must be less than 500 kHz.

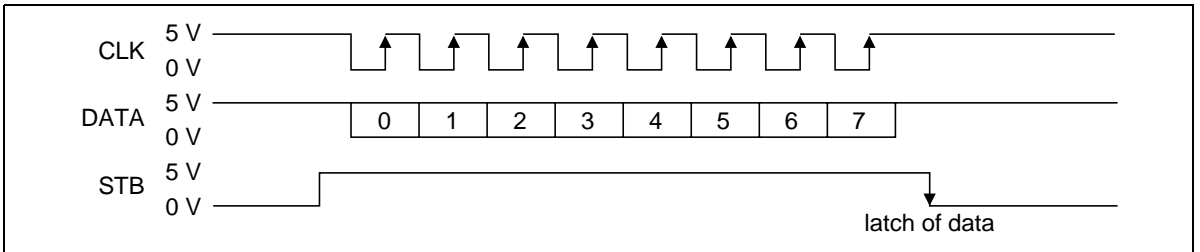

Figure 3 Serial Data Timing Chart

Table 4 Serial Data Formatting

Bit No.	Control register	Volume register																																																																																												
0	TAPE SELECT 1	H L	DAC0																																																																																											
		<table border="1"> <tr> <td>TS1 \ TS2</td> <td>H</td> <td>L</td> </tr> <tr> <td>H</td> <td>TAPE IV</td> <td>TAPE I</td> </tr> <tr> <td>L</td> <td>TAPE II</td> <td>TAPE I</td> </tr> </table>	TS1 \ TS2	H	L	H	TAPE IV	TAPE I	L	TAPE II	TAPE I	<table border="1"> <tr> <th colspan="6">bit No.</th> <th></th> </tr> <tr> <td>5</td> <td>4</td> <td>3</td> <td>2</td> <td>1</td> <td>0</td> <td>gain</td> </tr> <tr> <td>L</td> <td>L</td> <td>L</td> <td>L</td> <td>L</td> <td>L</td> <td>increase</td> </tr> <tr> <td>L</td> <td>L</td> <td>L</td> <td>L</td> <td>L</td> <td>H</td> <td rowspan="2">↑</td> </tr> <tr> <td>L</td> <td>L</td> <td>L</td> <td>L</td> <td>H</td> <td>L</td> </tr> <tr> <td>L</td> <td>L</td> <td>L</td> <td>L</td> <td>H</td> <td>H</td> <td rowspan="2">↓</td> </tr> <tr> <td colspan="6">-----</td> <td></td> </tr> <tr> <td colspan="6">-----</td> <td></td> </tr> <tr> <td colspan="6">-----</td> <td></td> </tr> <tr> <td>H</td> <td>H</td> <td>H</td> <td>H</td> <td>L</td> <td>H</td> <td rowspan="2">decrease</td> </tr> <tr> <td>H</td> <td>H</td> <td>H</td> <td>H</td> <td>H</td> <td>L</td> </tr> <tr> <td>H</td> <td>H</td> <td>H</td> <td>H</td> <td>H</td> <td>H</td> <td>mute</td> </tr> </table>	bit No.							5	4	3	2	1	0	gain	L	L	L	L	L	L	increase	L	L	L	L	L	H	↑	L	L	L	L	H	L	L	L	L	L	H	H	↓	-----							-----							-----							H	H	H	H	L	H	decrease	H	H	H	H	H	L	H	H	H	H	H	H	mute
TS1 \ TS2	H	L																																																																																												
H	TAPE IV	TAPE I																																																																																												
L	TAPE II	TAPE I																																																																																												
bit No.																																																																																														
5	4	3	2	1	0	gain																																																																																								
L	L	L	L	L	L	increase																																																																																								
L	L	L	L	L	H	↑																																																																																								
L	L	L	L	H	L																																																																																									
L	L	L	L	H	H	↓																																																																																								

H	H	H	H	L	H	decrease																																																																																								
H	H	H	H	H	L																																																																																									
H	H	H	H	H	H	mute																																																																																								
1	TAPE SELECT 2	H L	DAC1																																																																																											
2	TAPE SPEED	H L	High (double) speed selection Normal speed selection																																																																																											
3	METER SENSITIVITY	H L	Meter sensitivity 20 dB up Meter sensitivity normal																																																																																											
4	INPUT SELECT 1	H L	DAC4																																																																																											
		<table border="1"> <tr> <td>IS1 \ IS2</td> <td>H</td> <td>L</td> </tr> <tr> <td>H</td> <td>PB I</td> <td>VR I</td> </tr> <tr> <td>L</td> <td>RP I</td> <td>VR I</td> </tr> </table>	IS1 \ IS2	H	L	H	PB I	VR I	L	RP I	VR I																																																																																			
IS1 \ IS2	H	L																																																																																												
H	PB I	VR I																																																																																												
L	RP I	VR I																																																																																												
5	INPUT SELECT 2	H L	DAC 5																																																																																											
6	REC/PB	H L	PB mode selection REC mode selection																																																																																											
			R/L SELECT H Rch register selection L Lch register selection																																																																																											
7	REGISTER SELECT	H L	Control register selection Volume register selection																																																																																											
			REGISTER SELECT L																																																																																											

*mute is implemented when all bits are high.

Note: TAPE I: Normal tape, TAPE II: Chrome tape, TAPE IV: Metal tape

HA12155NT/HA12157NT

Input Block Diagram and Level Diagram

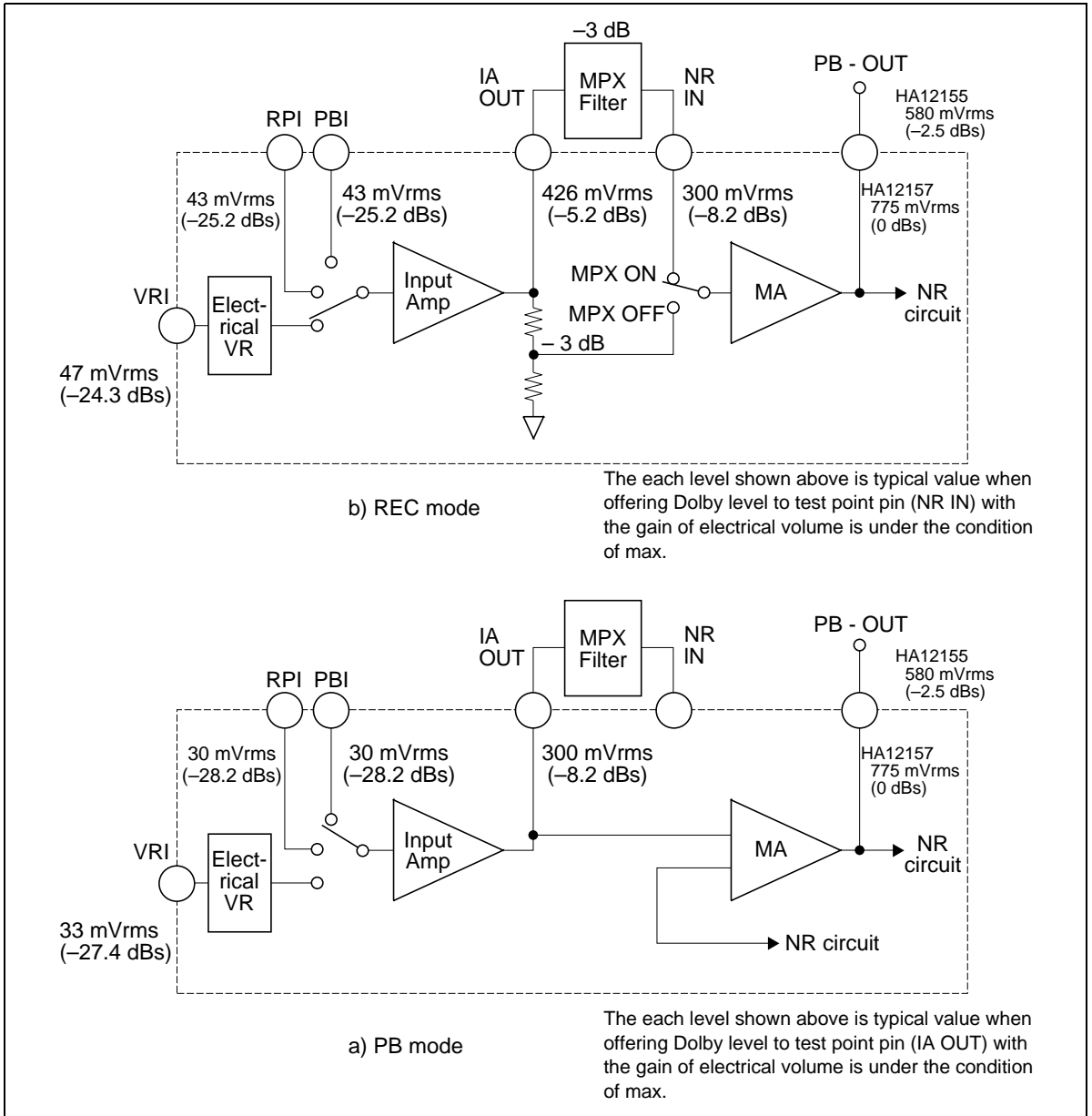

Figure 4 Input Block Diagram

MPX ON/OFF Switch

MPX-OFF mode means that signal from input amp doesn't go through the MPX filter, but signal goes through the SS circuit after being attenuated 3 dB by internal resistor. Refer to figure 5. For not cause any level difference between MPX-ON mode and MPX-OFF mode, it is requested to use MPX-filter which has definitely 3 dB attenuated. MPX-OFF mode offer totally flat frequency response and no bias-trap effect. And when applying other usage except figure 5, take consideration to give bias voltage to NR-IN terminal by resistor or so on because internal of NR-IN terminal has no bias resistor.

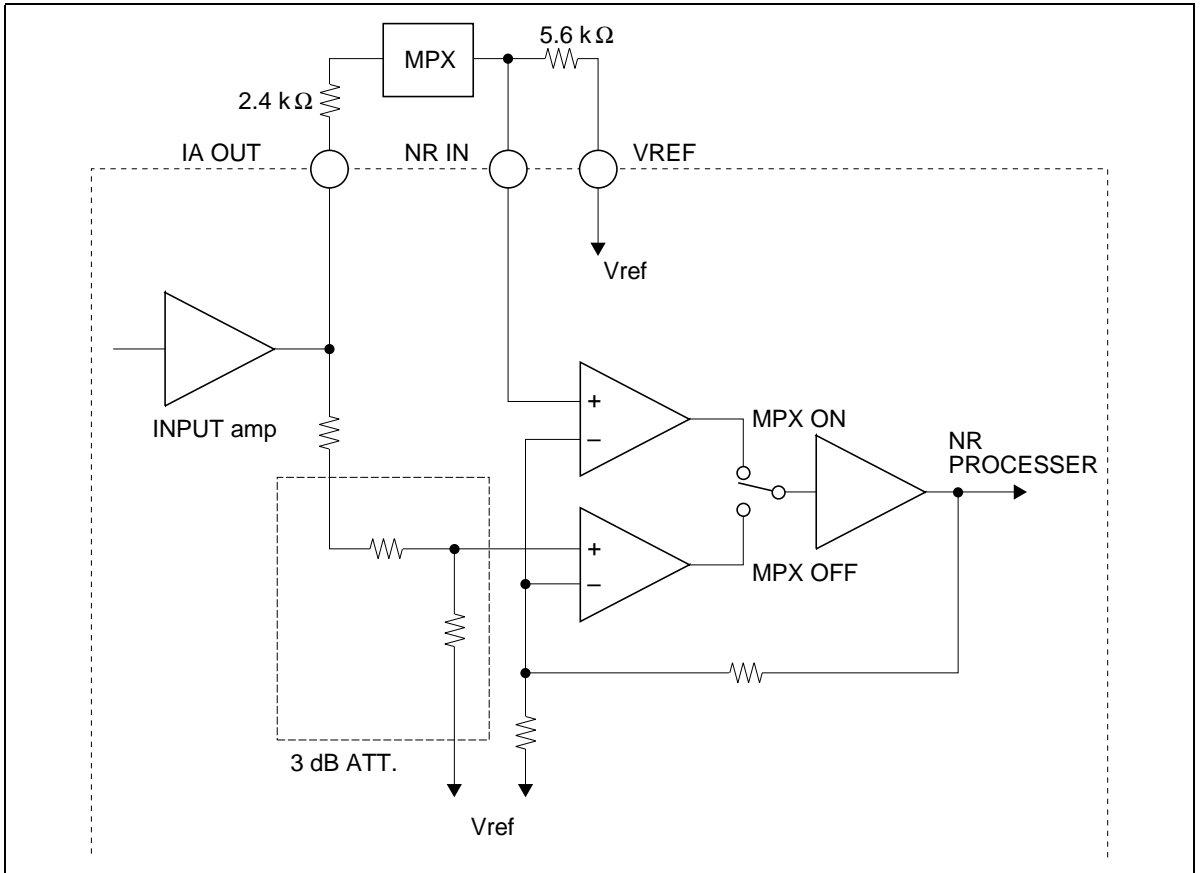

Figure 5 MPX ON/OFF Switch Block Diagram

Application as for the Dubbing Cassette Deck

HA12155NT/HA12157NT series has unprocessor signal from recording out terminals during playback mode. So, it is simply applied for dubbing cassette decks.

And HA12155NT/HA12157NT has three input terminal. So, it is applicable to switch the signal from PB-EQ as shown below.

HA12155NT/HA12157NT

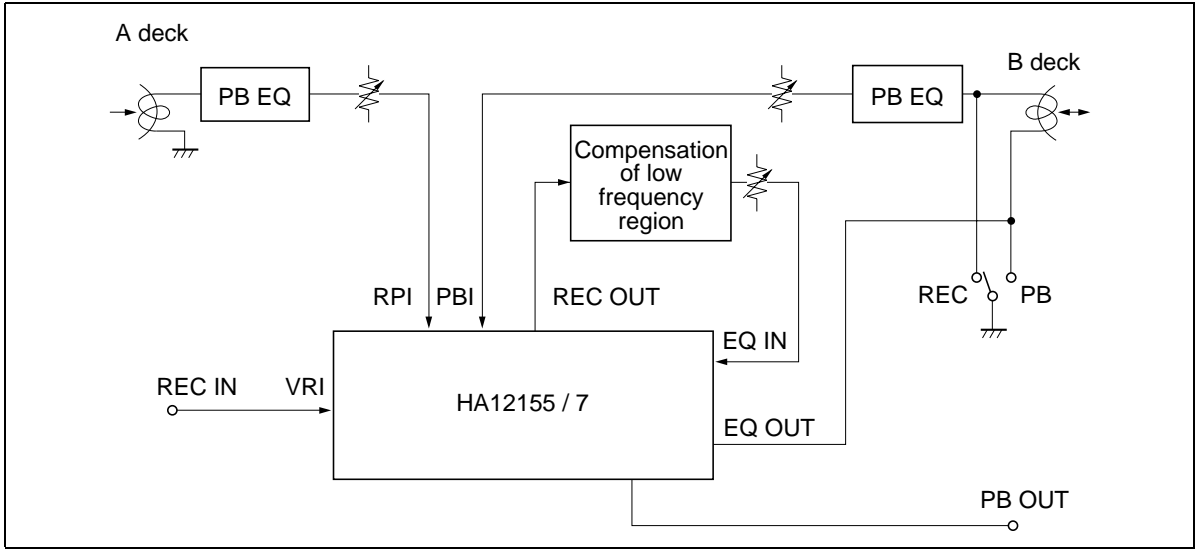

Figure 6 Application for Dubbing Deck

Injector Current

HA12155NT/HA12157NT has logic circuit which is fabricated by I²L into IC. To operate this circuit, it is required enough injector current. Injector current goes into from the INJ pin (pin 10) and external resistor is required to connect to this pin for adequate current. The value of external resistor is obtained by using following equations. And put them with $\pm 10\%$ tolerance value which is calculated. V_{INJ} can allow to connect to V_{CC} shown below. Under the condition of high temperature, the mis-operation of logic is caused by large injector current. Also, under the condition of low temperature, the stop of logic is caused by small injector current. Therefore, pay attention to have good stability of V_{INJ} .

$$R_{INJ} = \frac{V_{INJ} - 0.7}{3.6} \quad [\text{k}\Omega] \text{ ---- Single supply}$$

$$R_{INJ} = \frac{V_{INJ} + V_{EE} - 0.7}{3.6} \quad [\text{k}\Omega] \text{ ---- Split supply}$$

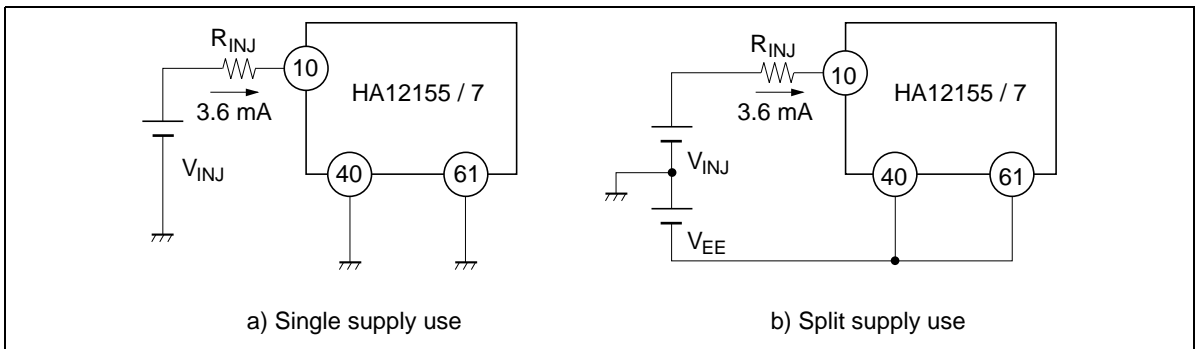

Figure 7 Injector Current Application

Gain Control of Electronic Volume

HA12155NT/HA12157NT is designed in order to change the gain by 6 bit DAC fabricated into IC. To reduce the click noise when changing volume gain instantaneously, required to connect the capacitor (CR time constant) to CNT pin (pin 6,59). These terminals are also be used as output pin of DAC. Therefore, by forcing voltage or current to these terminals, it is applicable to control volume gain directly. But, voltage forced to these terminals must be from $V_{cc}/2 - 2\text{ V}$ to $V_{cc}/2$ (for split supply use, -2 V to 0 V) in this case. In case of forcing the current these pins, voltage must be the value mentioned above even it is $\pm 20\%$ distributed of internal resistor ($5.2\text{ k}\Omega$) of CNT pin. And, these case, change of a gain depending on a temperature gets large.

The Tolerances of External Components for Dolby NR-Block

For adequate Dolby NR tracking response, take external components shown below.

For smooth capacitors of C13, C14, C25 and C26, please employ a few object of the leak, though you can be useful for an electrolytic capacitor.

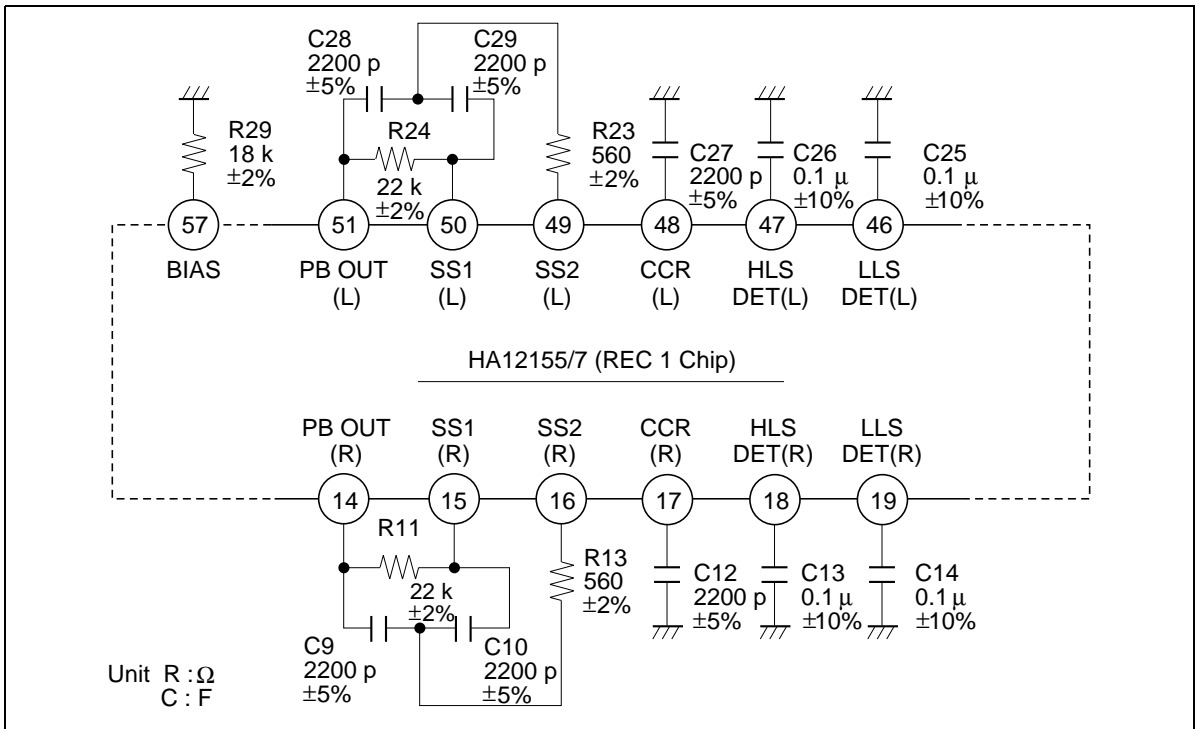

Figure 8 Tolerances of External Components

Level Meter

The coupling capacitor of LMIN pin (21 pin and 44 pin).

For these capacitors please employ a small object of the leak.

HA12155NT/HA12157NT

The Application of Equalizer Frequency Response

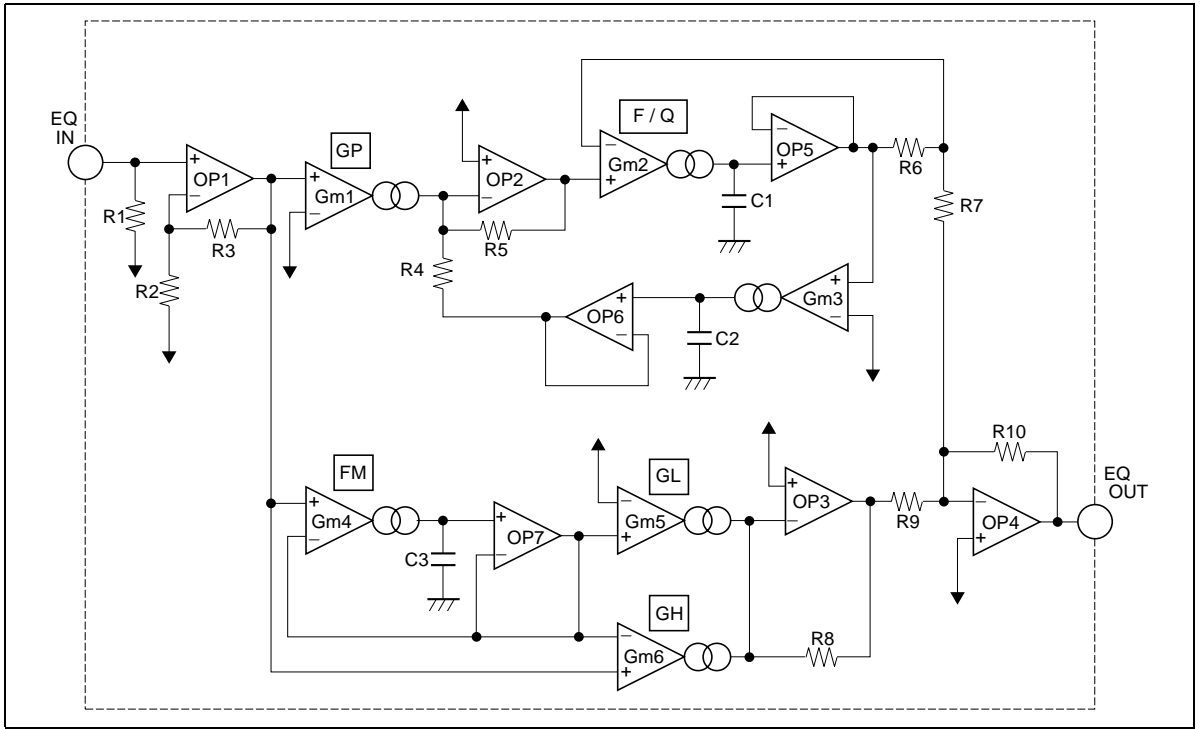

Figure 9 REC Equalizer Block Diagram

Transfer Function:

$$\frac{V_{out}}{V_{in}} = \frac{R_2 + R_3}{R_2} \left(G_{m5} \frac{R_8 \cdot R_{10}}{R_9} \frac{1 + \frac{C_3 \cdot G_{m6}}{G_{m4} \cdot G_{m5}} S}{1 + \frac{C_3}{G_{m4}} S} + G_{m1} \frac{R_4 \cdot R_{10}}{R_6 + R_7} \frac{\frac{C_2}{G_{m3}} S}{1 + \frac{R_4}{R_5} \frac{R_7}{R_6 + R_7} \frac{C_2}{G_{m3}} S + \frac{R_4}{R_5} \frac{C_1}{G_{m2}} \frac{C_2}{G_{m3}} S^2} \right)$$

$$= \frac{4.16}{R_{REF}} \left(R_{GL} \frac{1 + 6.67 \times 10^{-10} \frac{R_{FM} \cdot R_{GH}}{R_{GL}} \cdot S}{1 + 6.67 \times 10^{-10} R_{FM} \cdot S} + R_{GP} \frac{3.0 \times 10^{-10} \cdot R_{FQ} \cdot S}{1 + 4.5 \times 10^{-11} \cdot R_{FQ} \cdot S + 2.5 \times 10^{-20} \cdot R_{FQ} \cdot R_{F/Q} S^2} \right)$$

*R_{REF}-----25 pin bias resistance

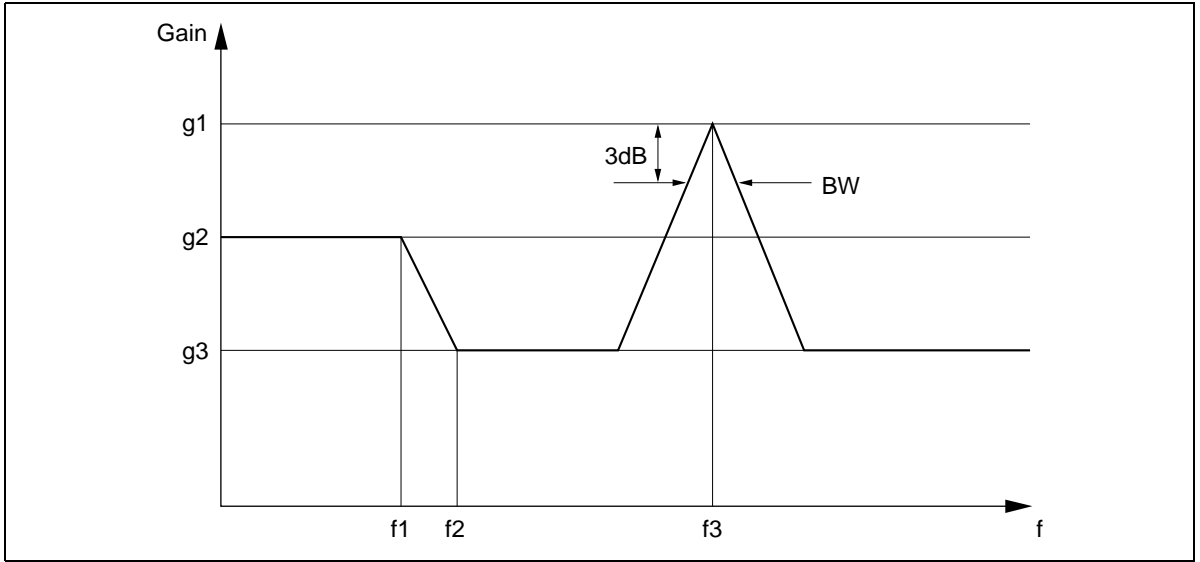

Figure 10 REC Equalizer Frequency Response

$$g1 = \frac{4.16}{R_{REF}} (6.67 \times R_{GP} + R_{GH})$$

$$g2 = \frac{4.16 \times R_{GL}}{R_{REF}}$$

$$g3 = \frac{4.16 \times R_{GH}}{R_{REF}}$$

$$f1 = \frac{1}{2\pi \times 6.67 \times 10^{-10} \times R_{FM}}$$

$$f2 = \frac{R_{GL}}{2\pi \times 6.67 \times 10^{-10} \times R_{FM} \times R_{GH}}$$

$$f3 = \frac{1}{2\pi} \cdot \frac{0.3}{\sqrt{2.25 \times 10^{-21} \times R_{FQ} \times R_{F/Q}}}$$

$$BW = \frac{1}{4\pi \times 2.78 \times 10^{-10} \times R_{F/Q}}$$

$$Q = \frac{f3}{BW} = 3.51 \times \sqrt{\frac{R_{F/Q}}{R_{F/Q}}}$$

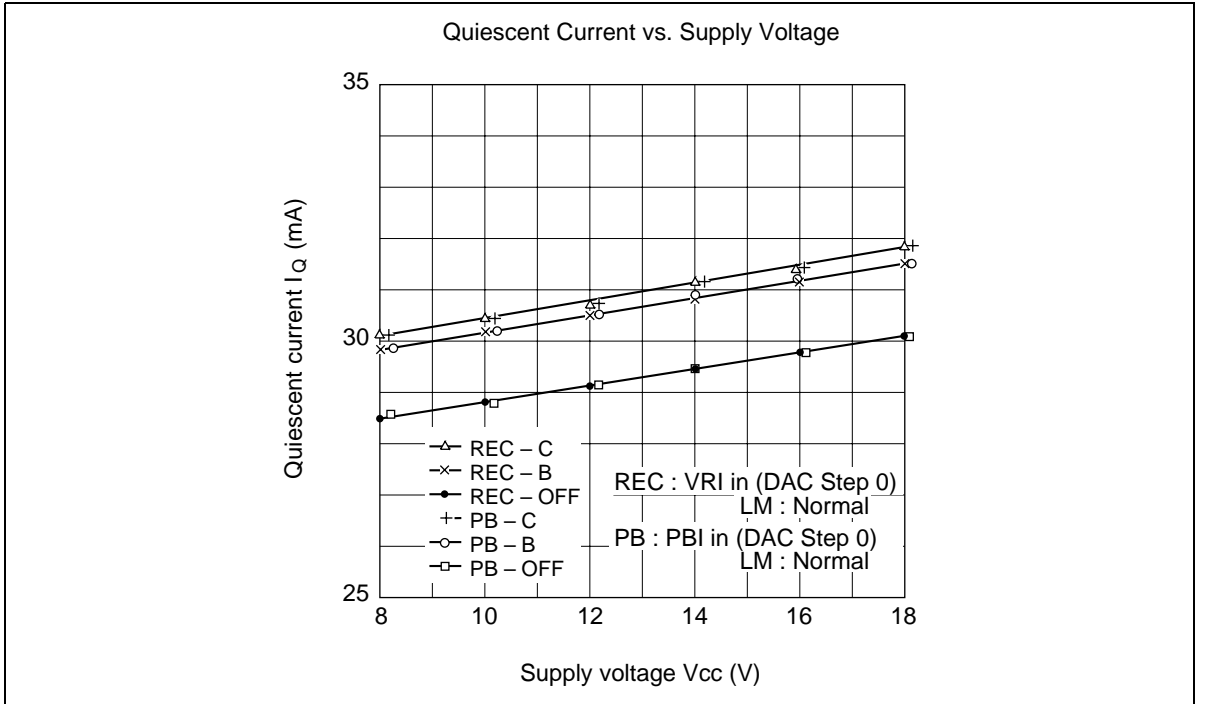

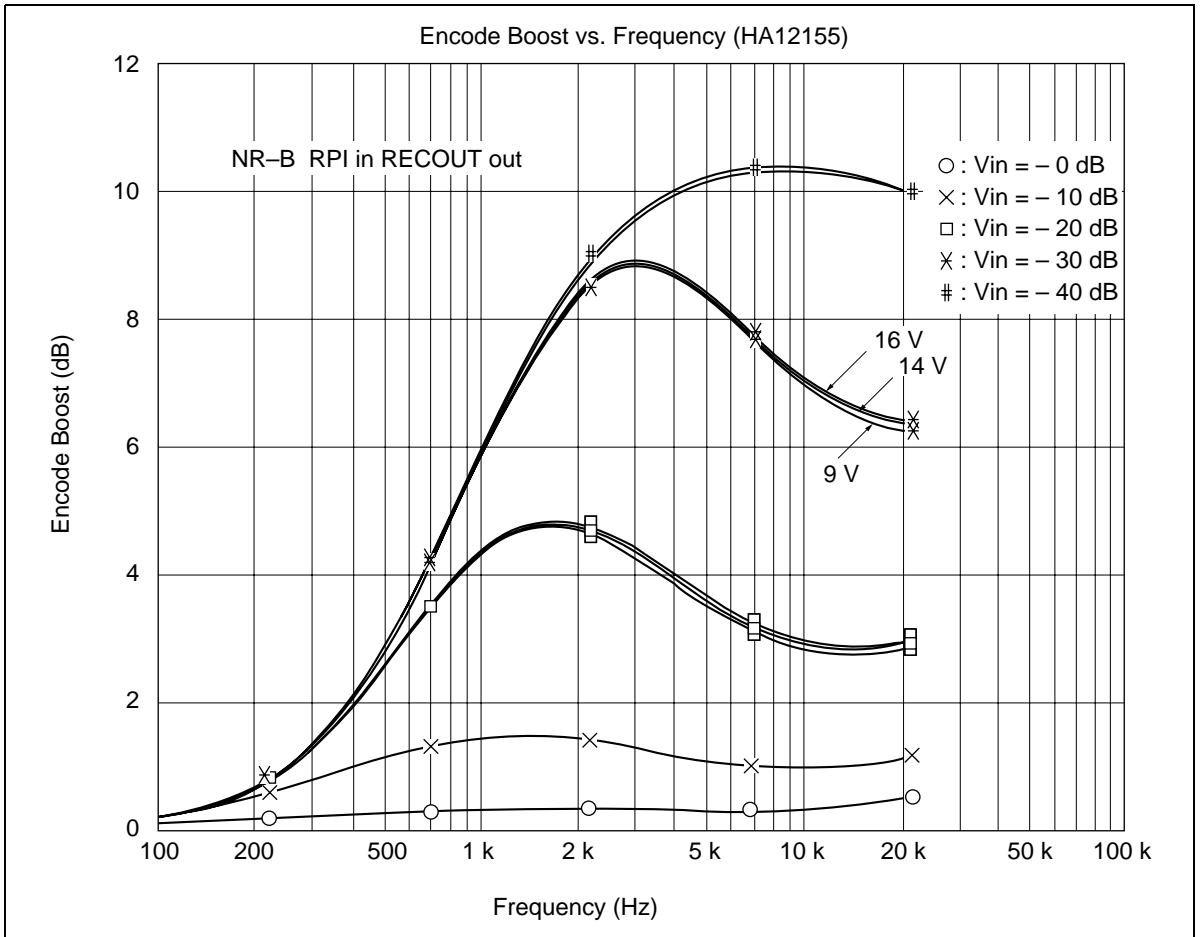

HA12155NT/HA12157NT

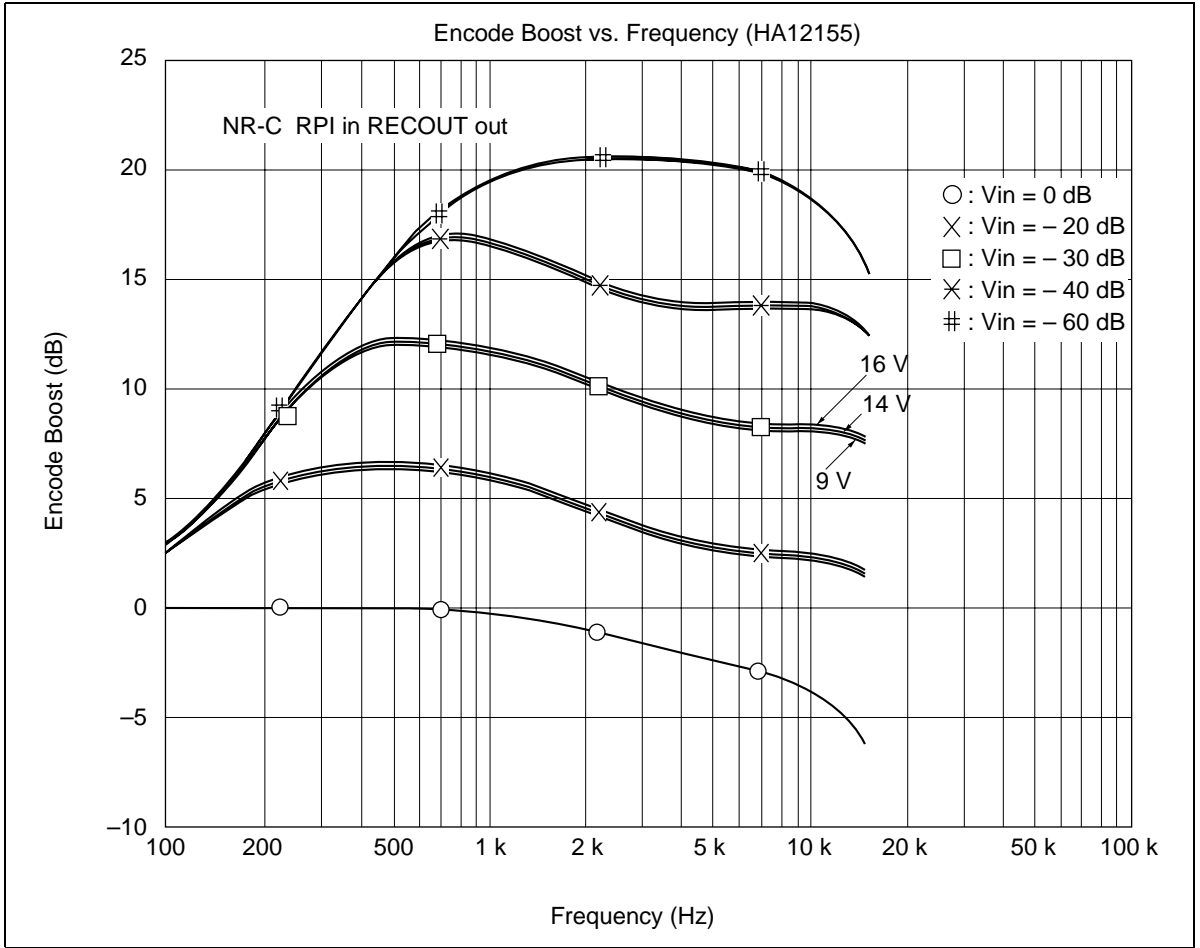

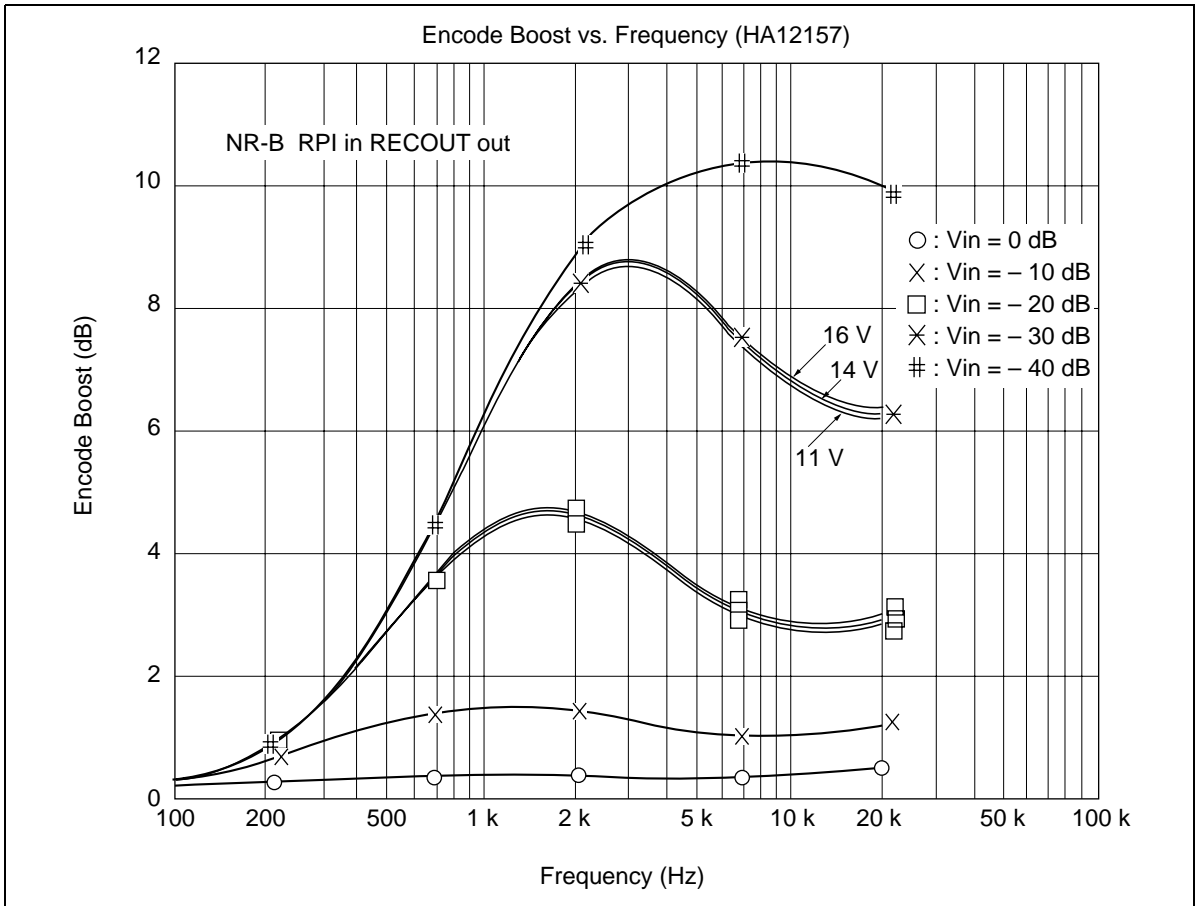

HA12155NT/HA12157NT

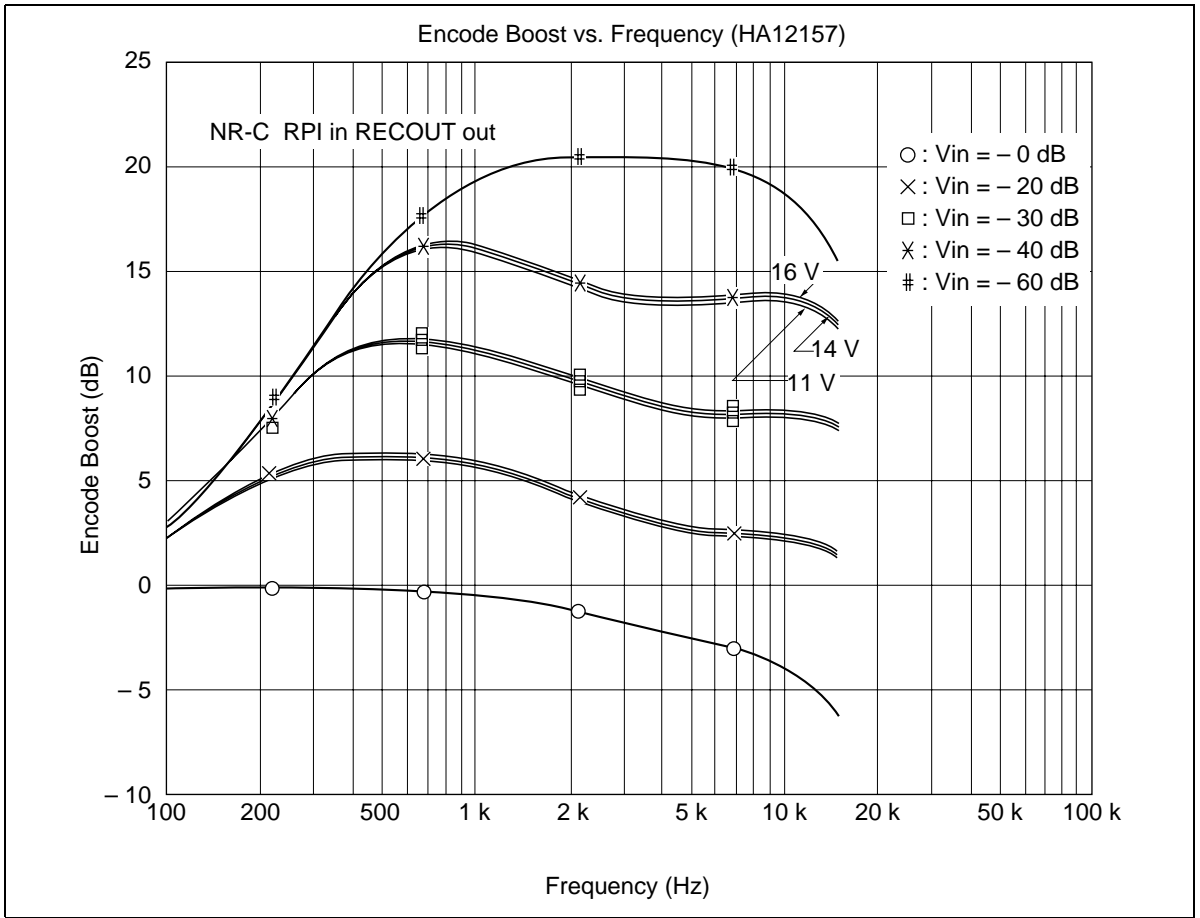

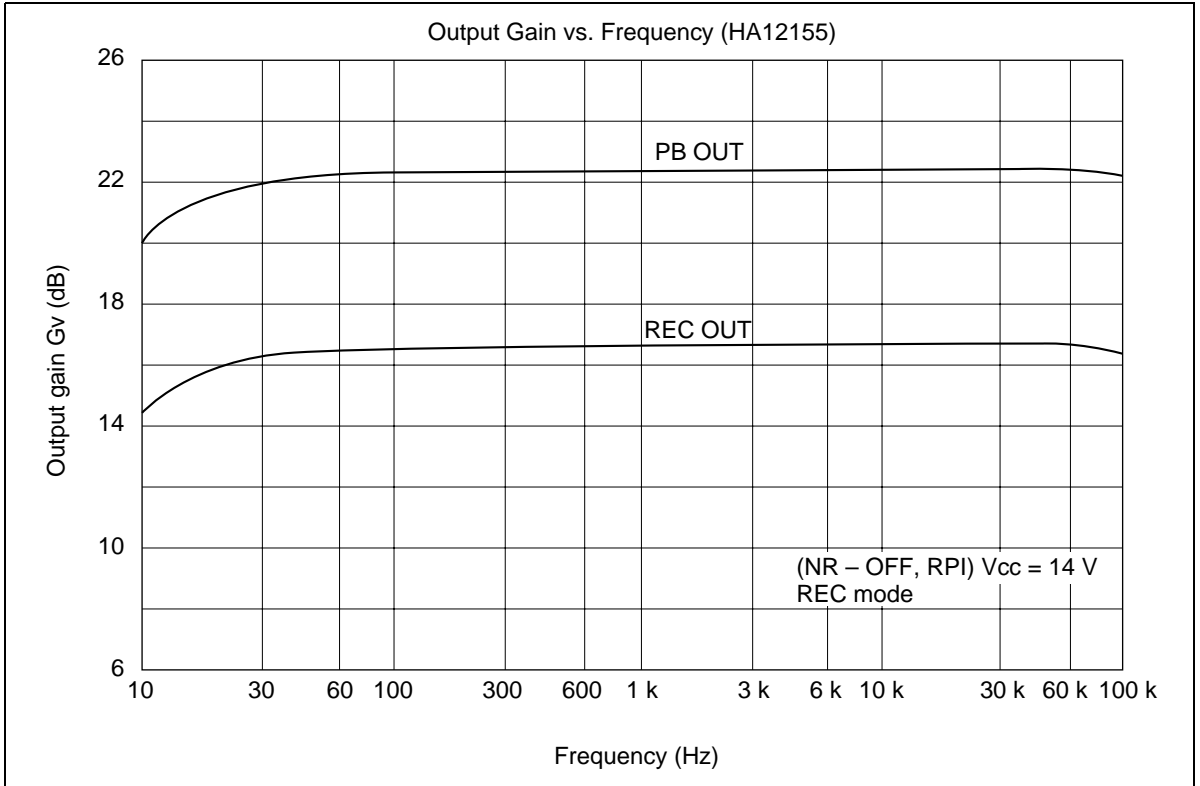

HA12155NT/HA12157NT

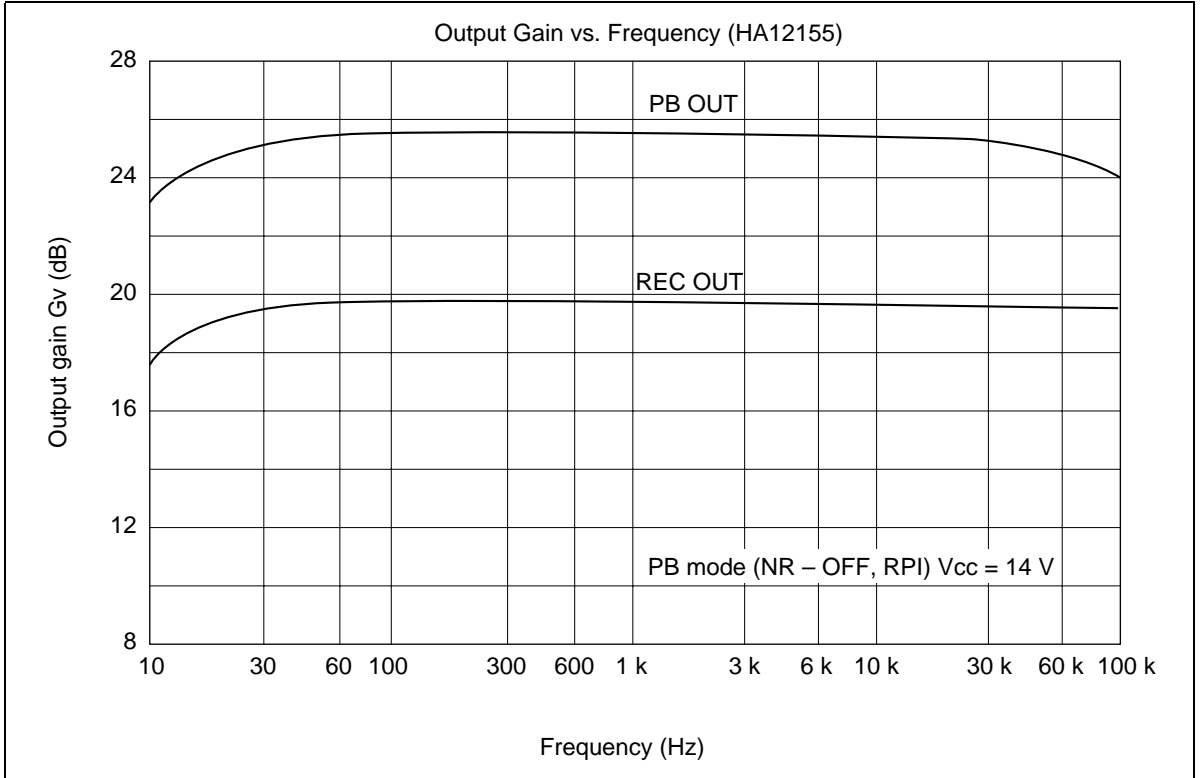

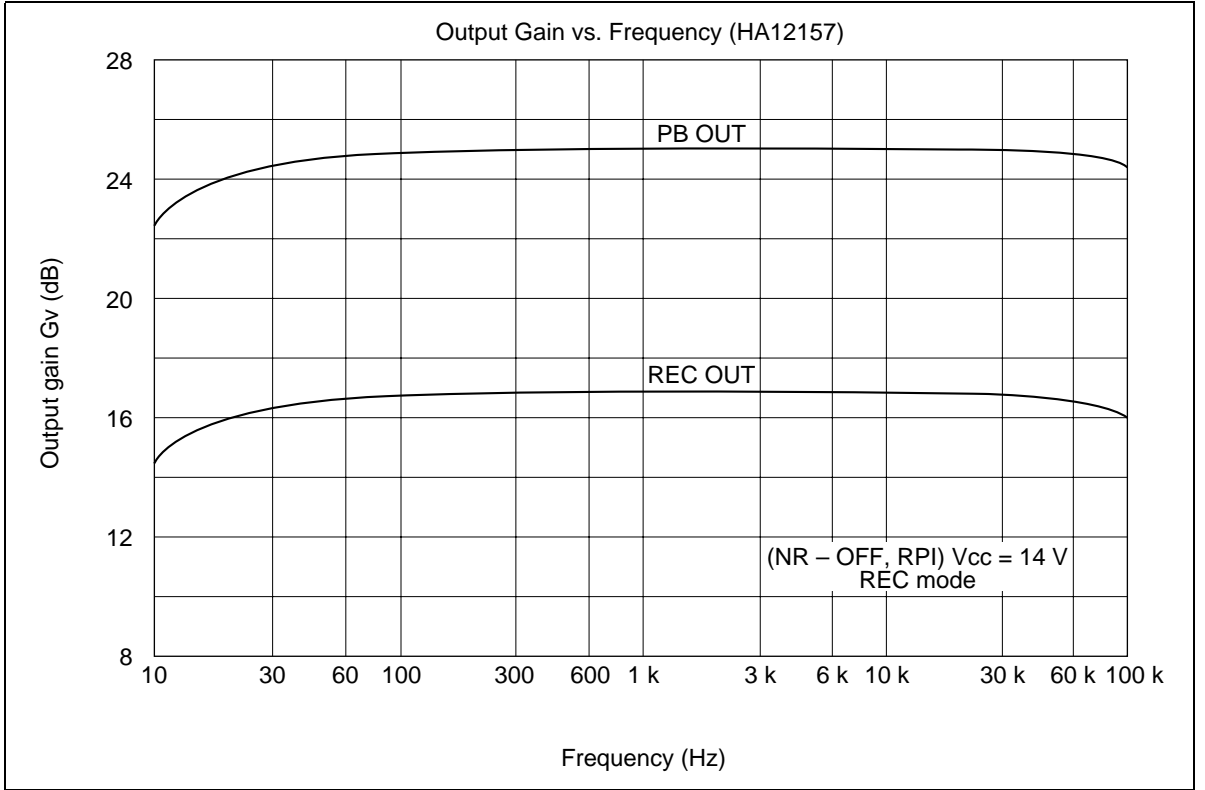

HA12155NT/HA12157NT

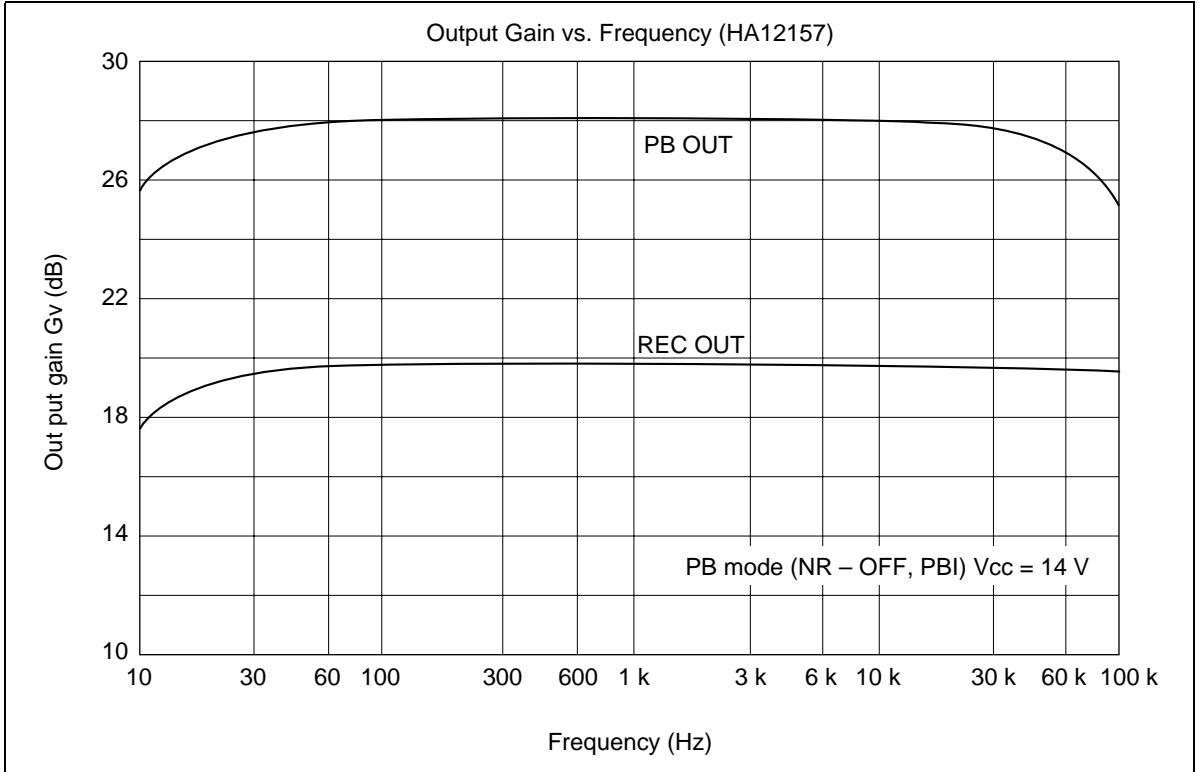

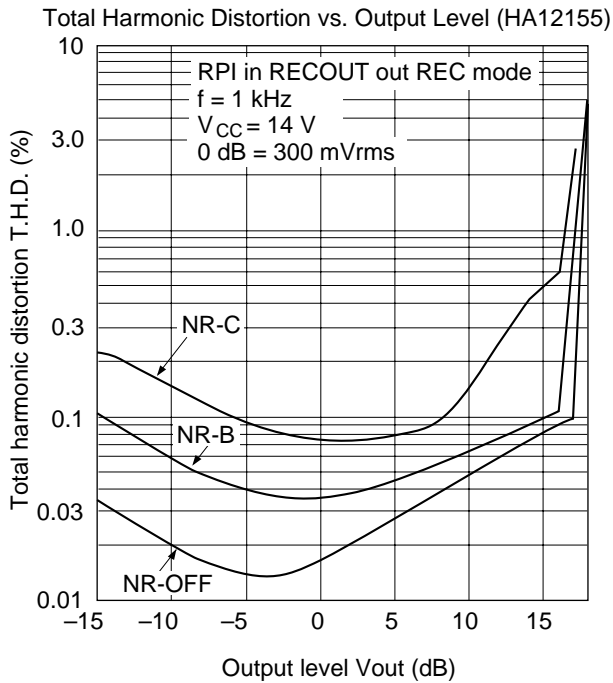
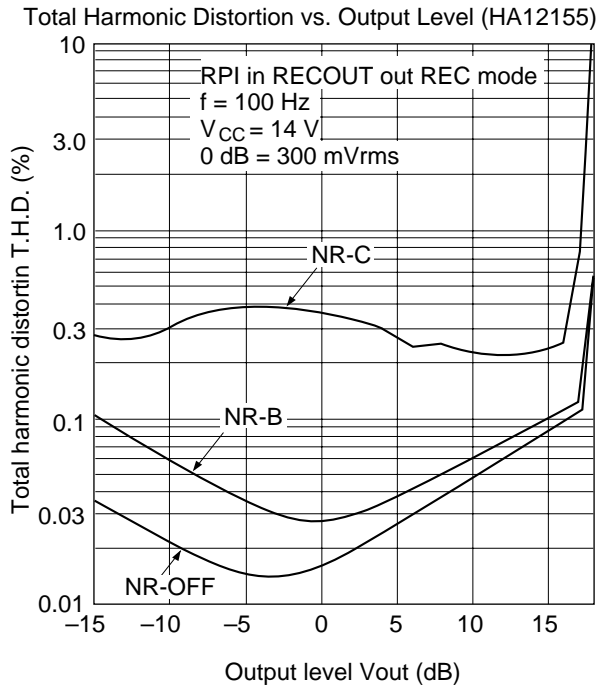

HA12155NT/HA12157NT

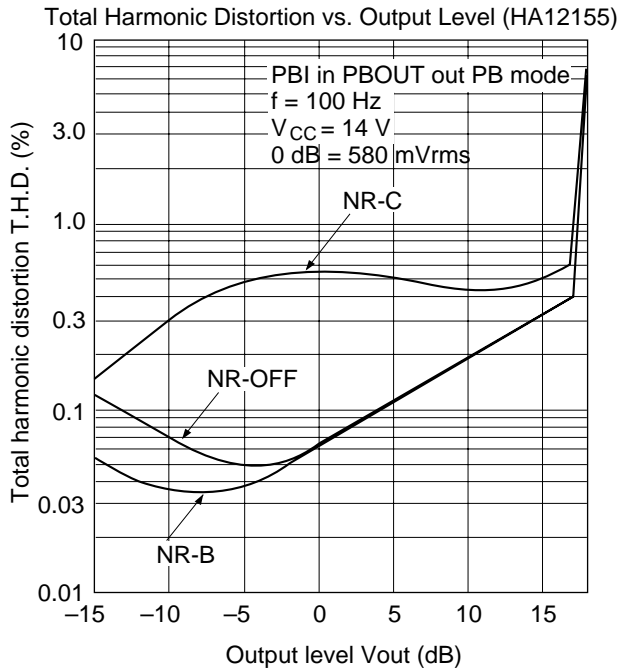
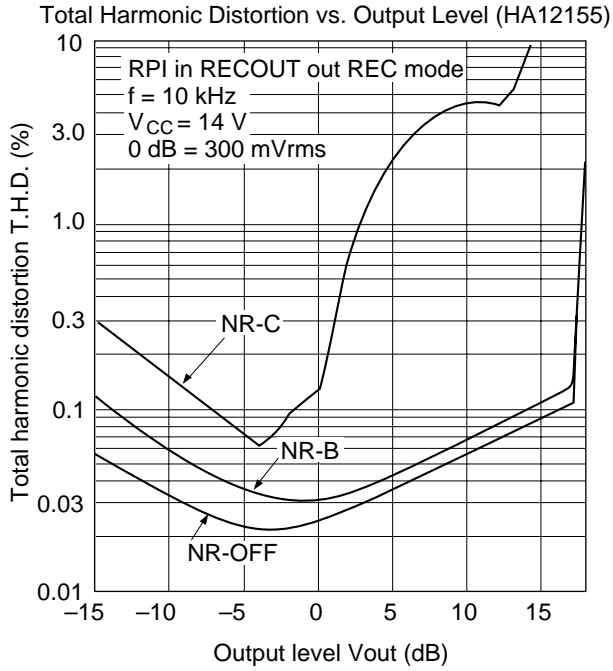

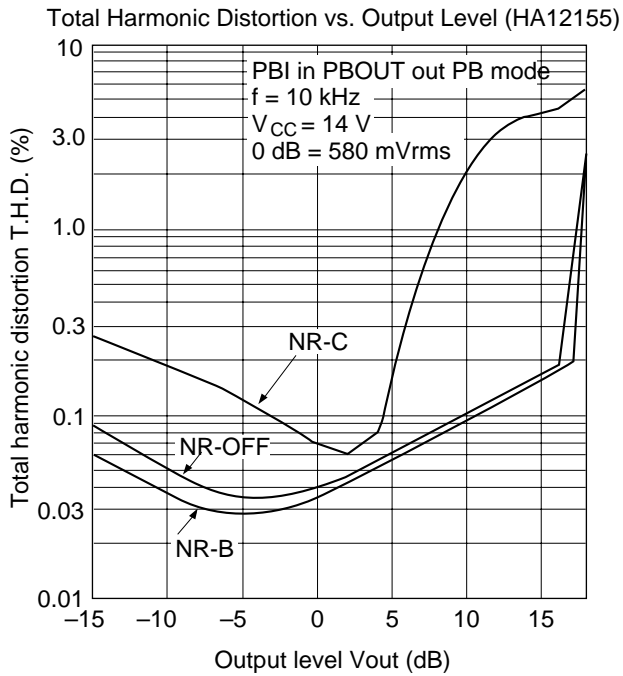
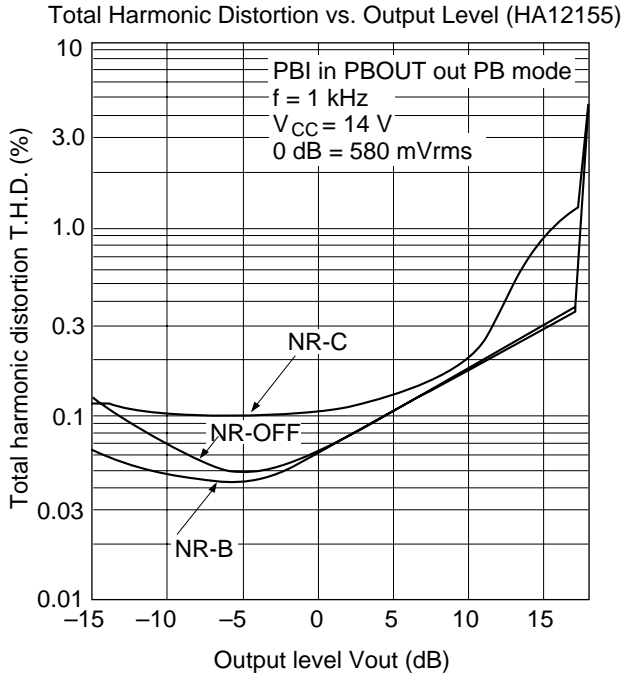

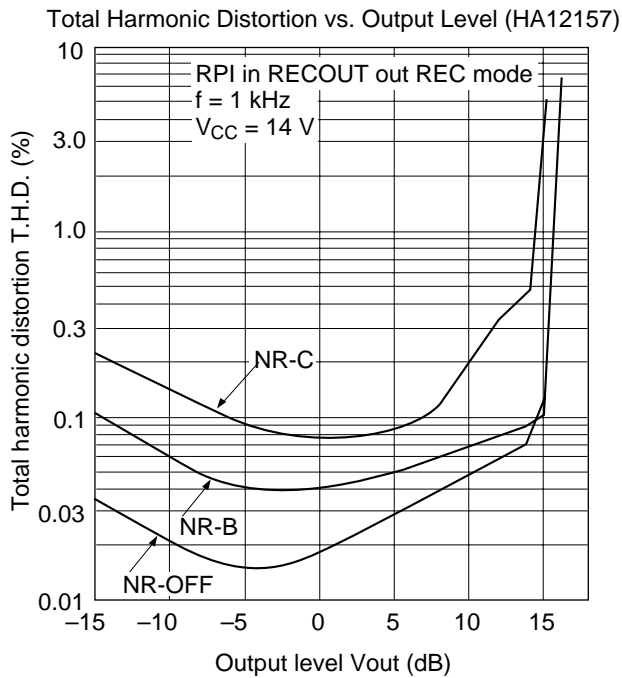
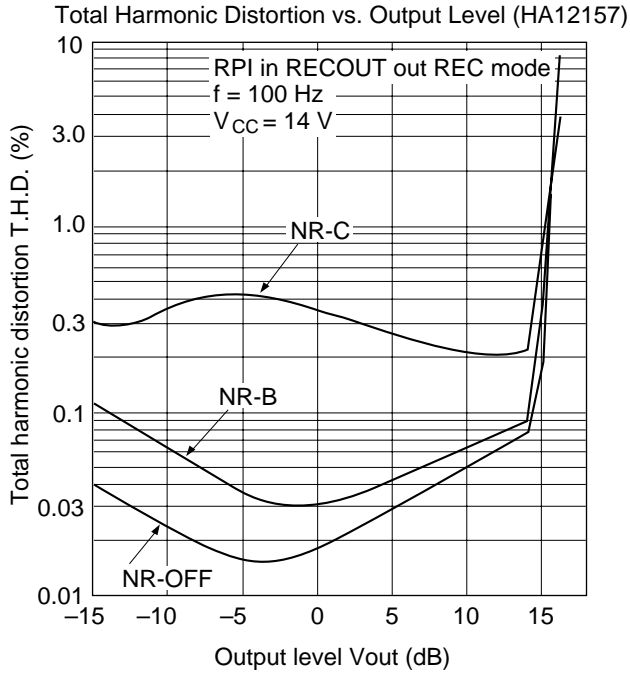

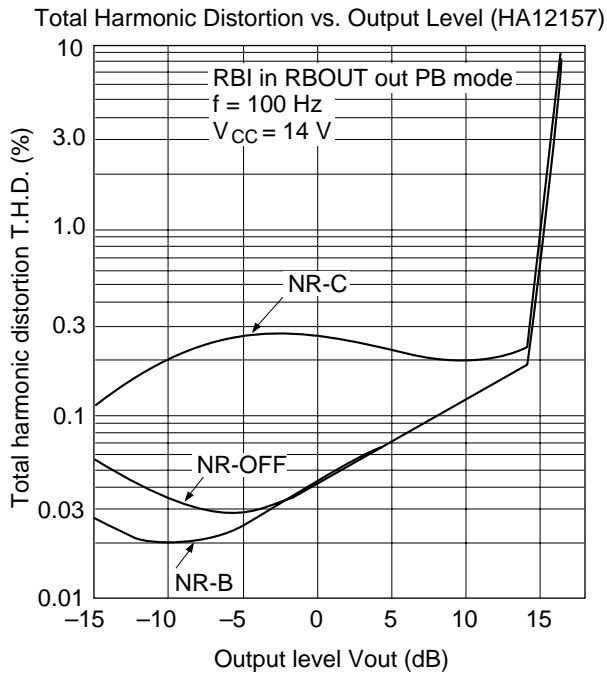
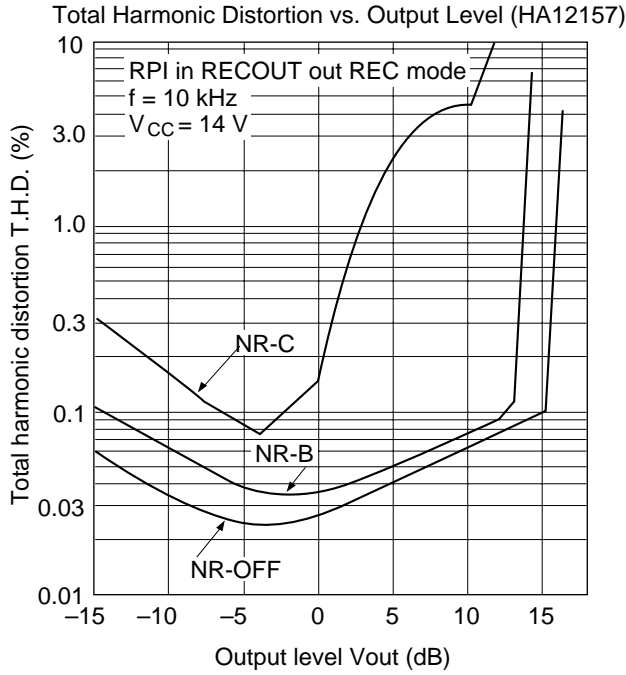

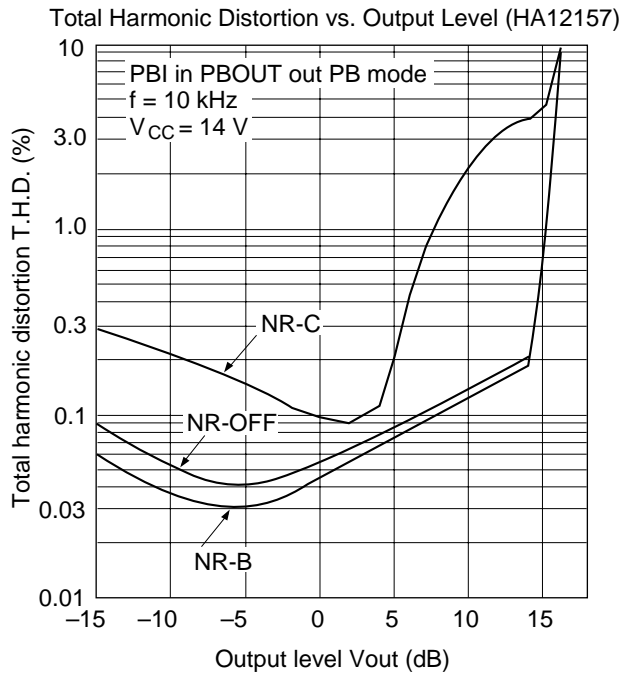
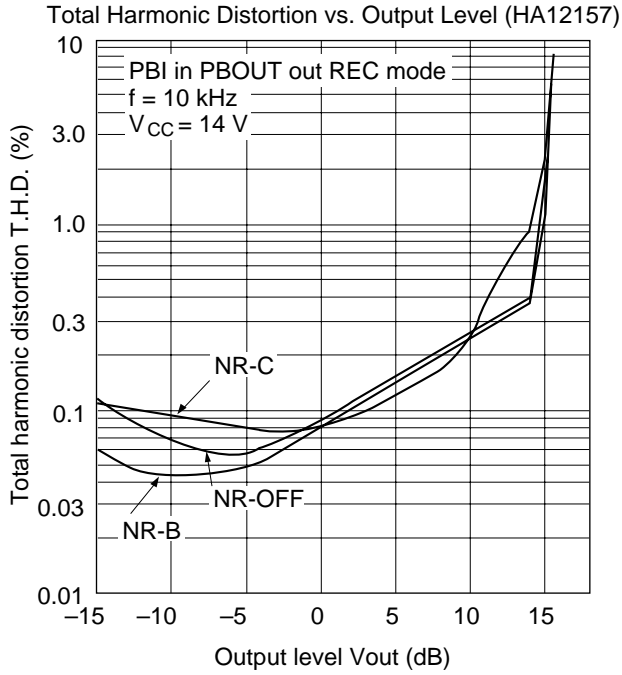

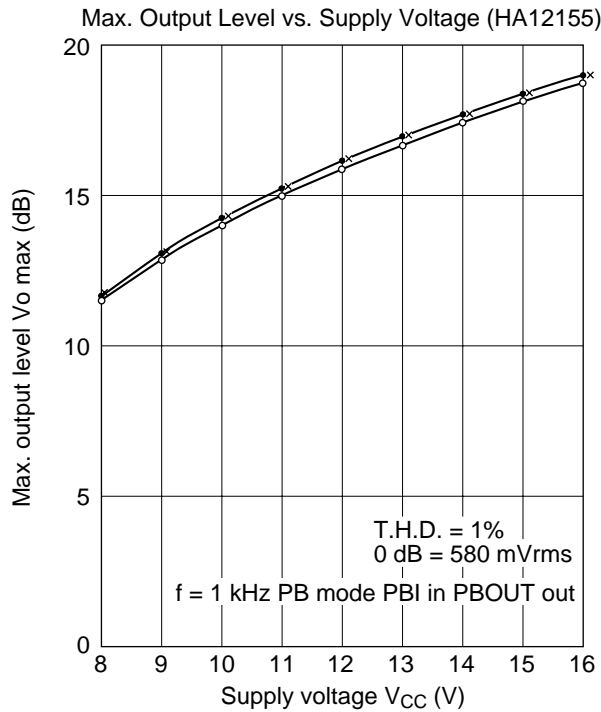
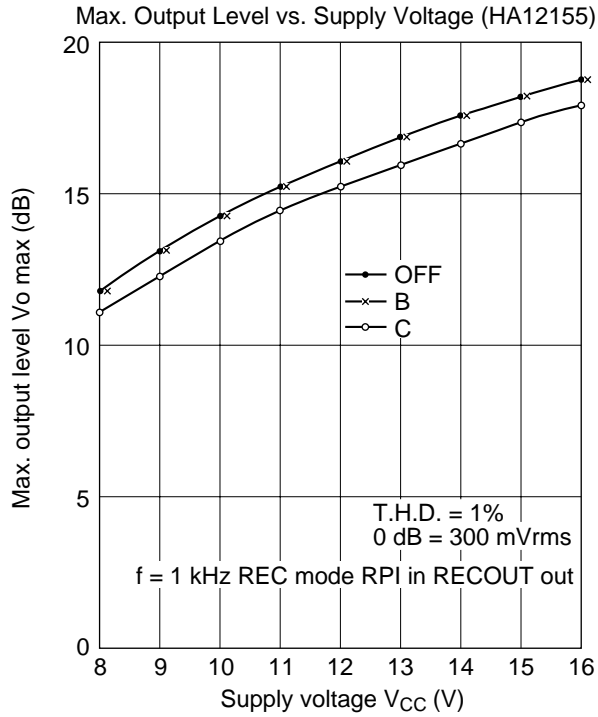

HA12155NT/HA12157NT

Max. Output Level vs. Supply Voltage (HA12157)

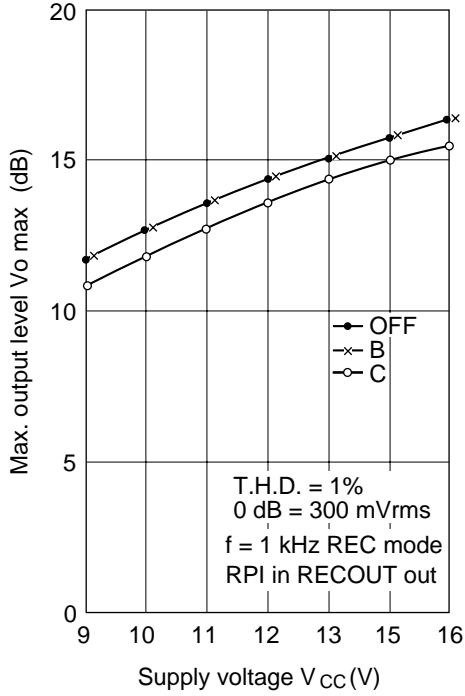

Max. Output Level vs. Supply Voltage (HA12157)

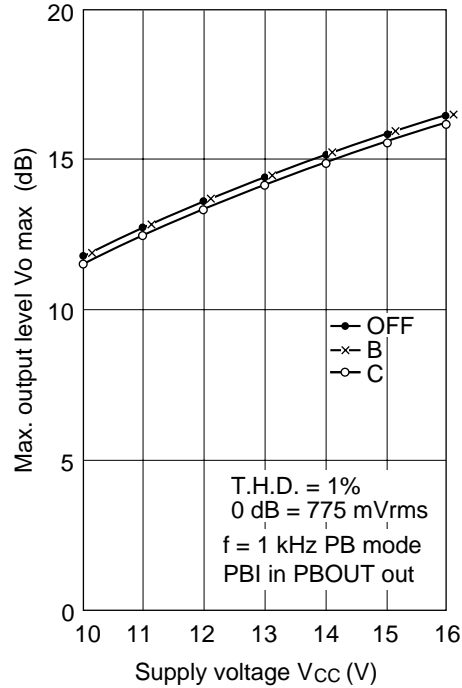

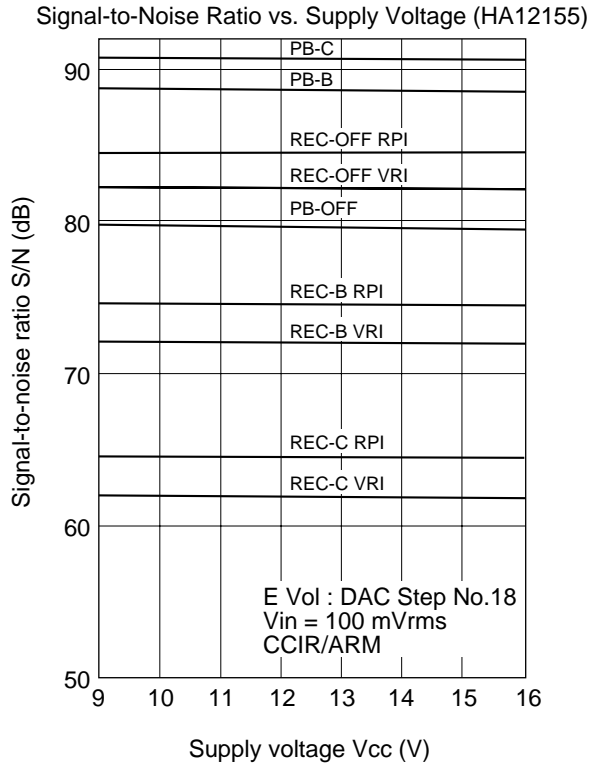

Signal-to-Noise Ratio vs. Supply Voltage (HA12157)

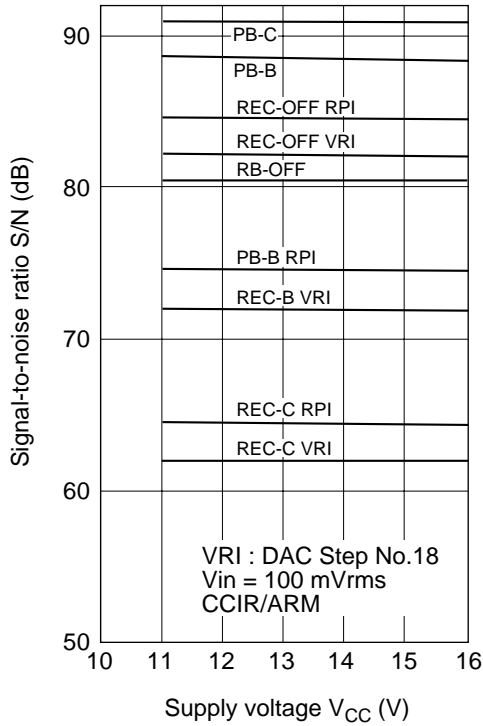

Crosstalk vs. Frequency (R → L)

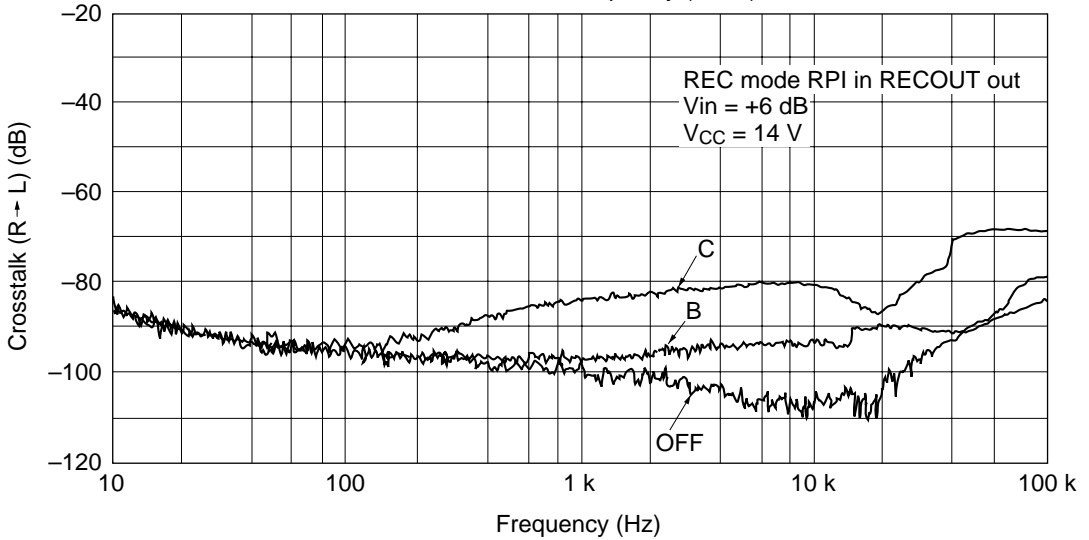

Crosstalk vs. Frequency (R → L)

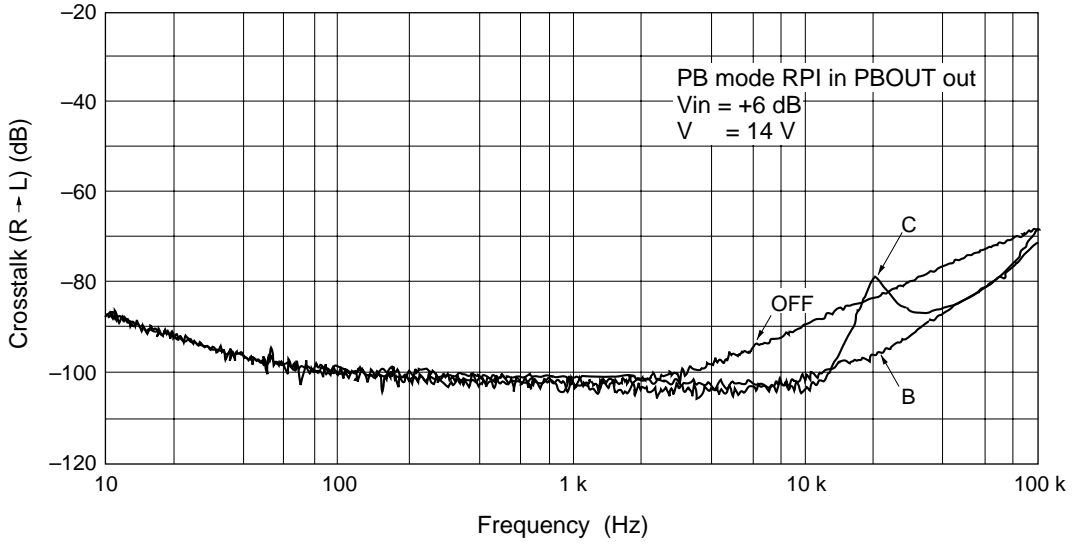

Crosstalk vs. Frequency

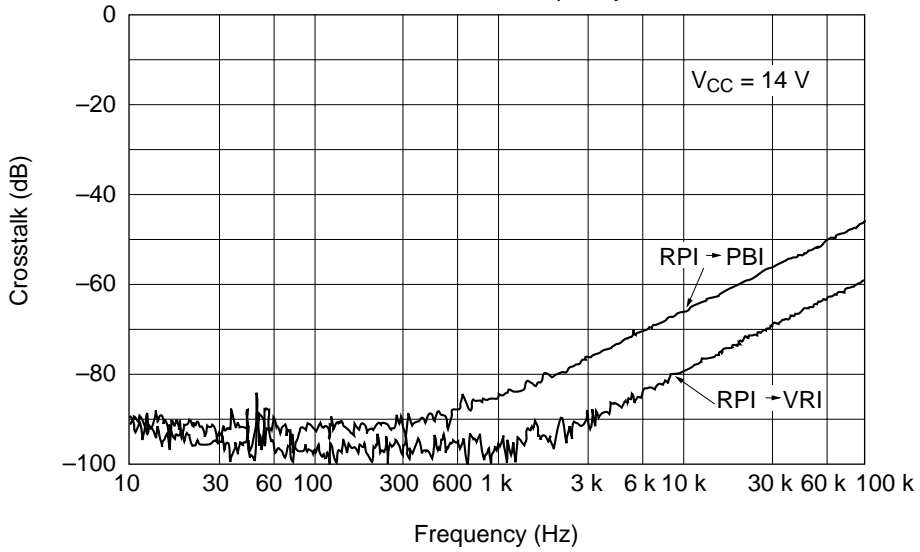

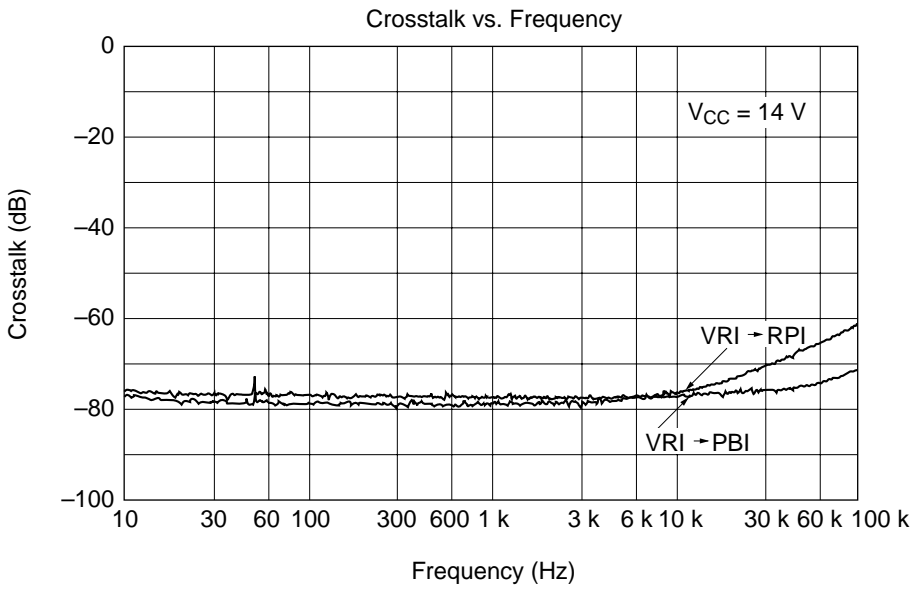
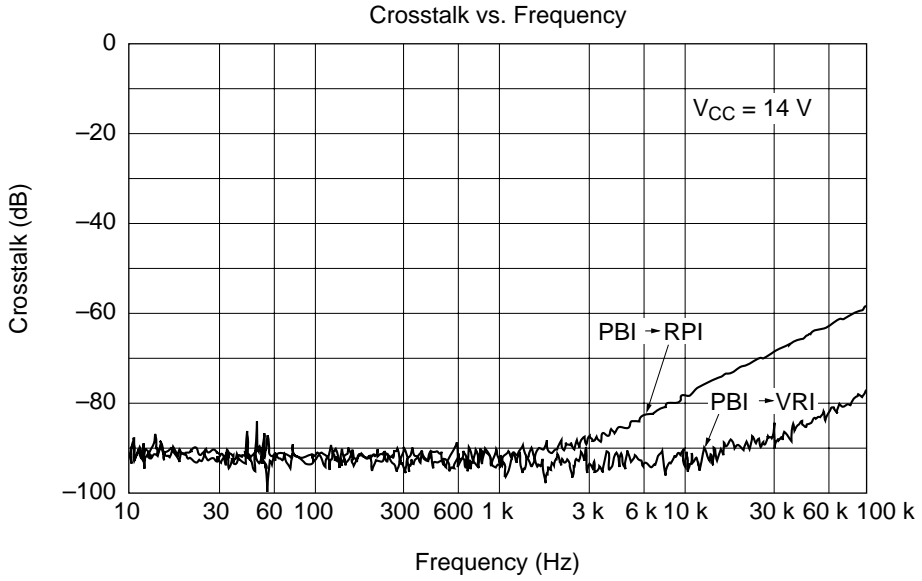

Ripple Rejection Ratio vs. Frequency (REC mode)

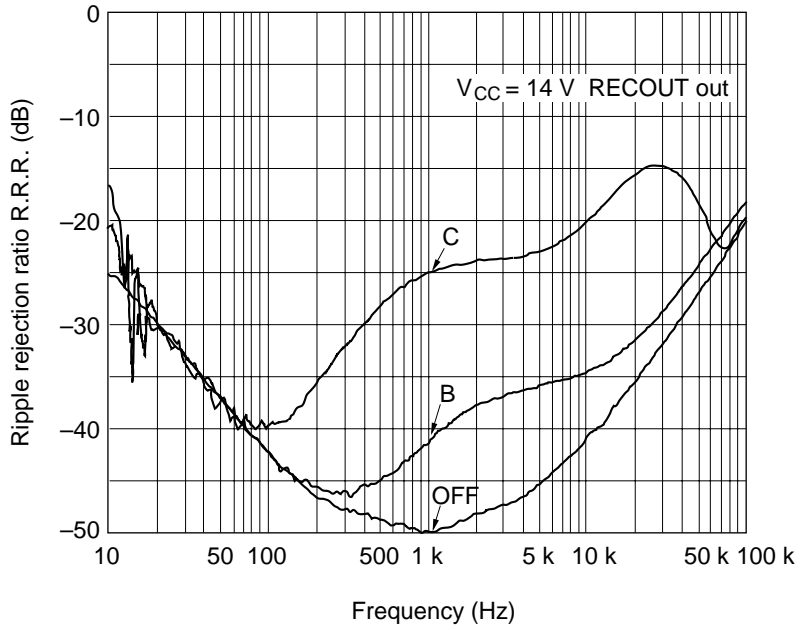

Ripple Rejection Ratio vs. Frequency (PB mode)

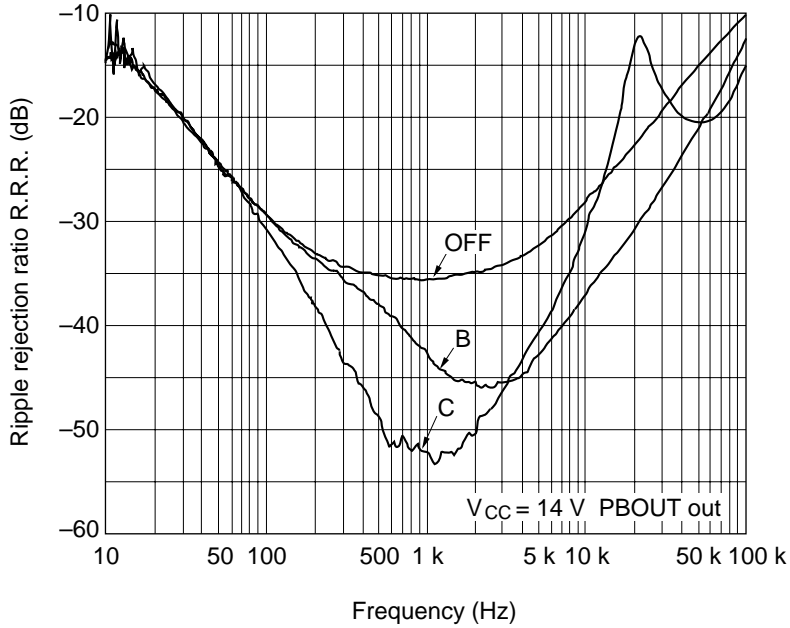

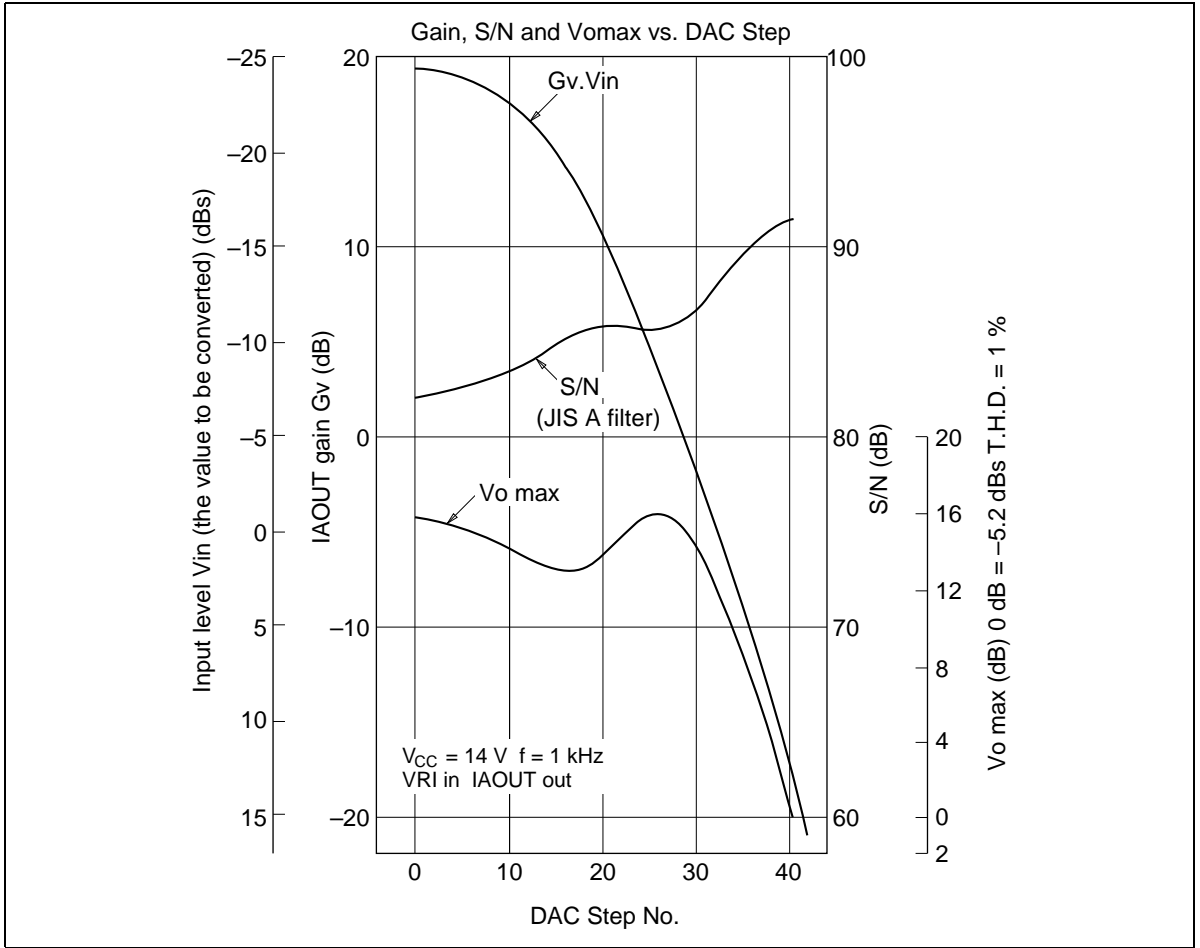

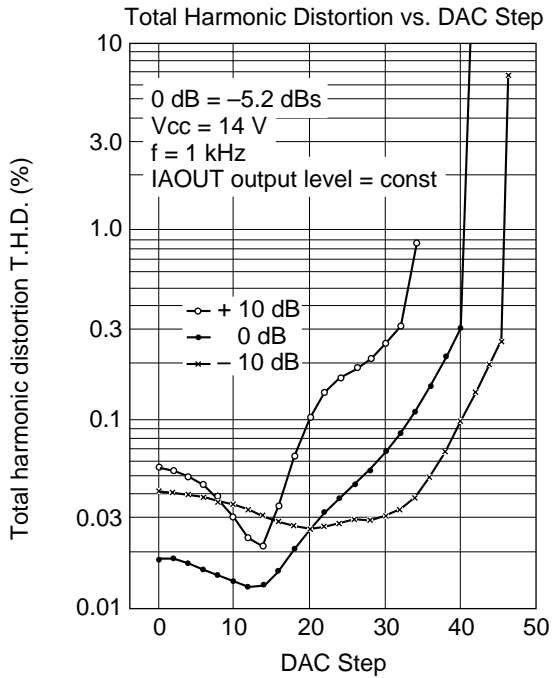
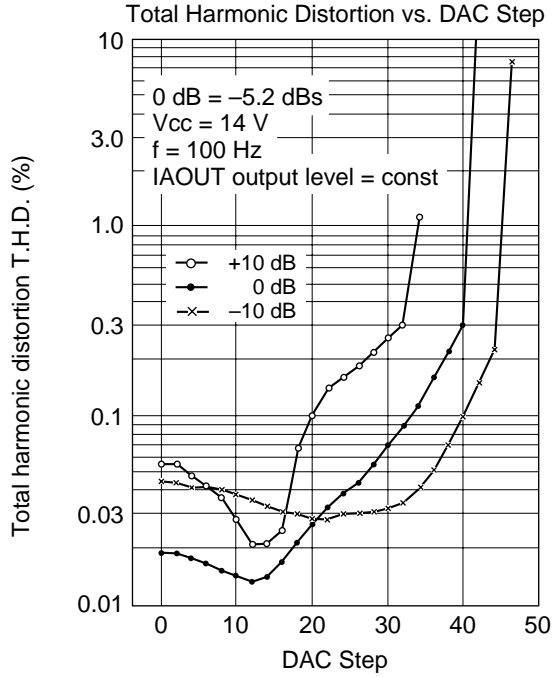

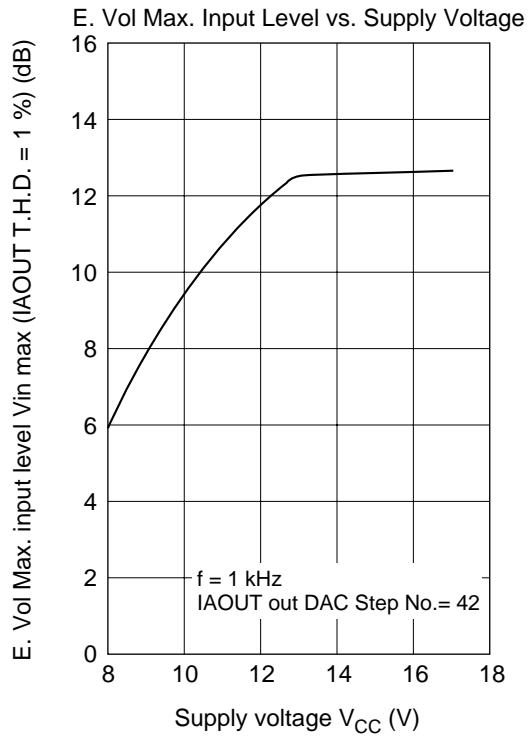
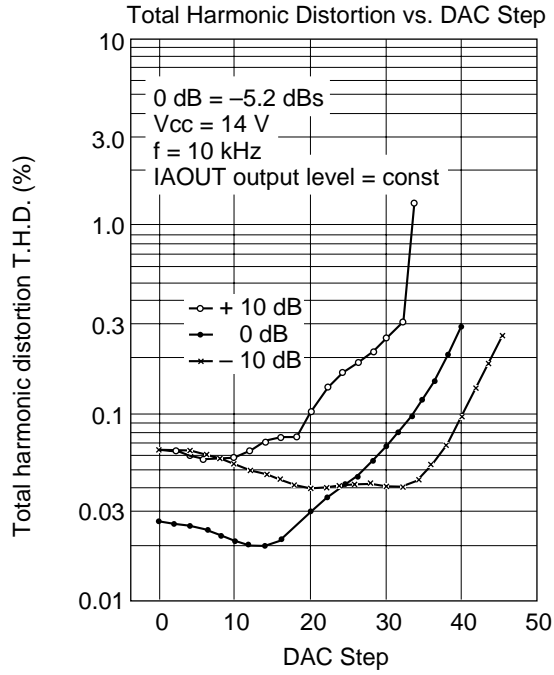

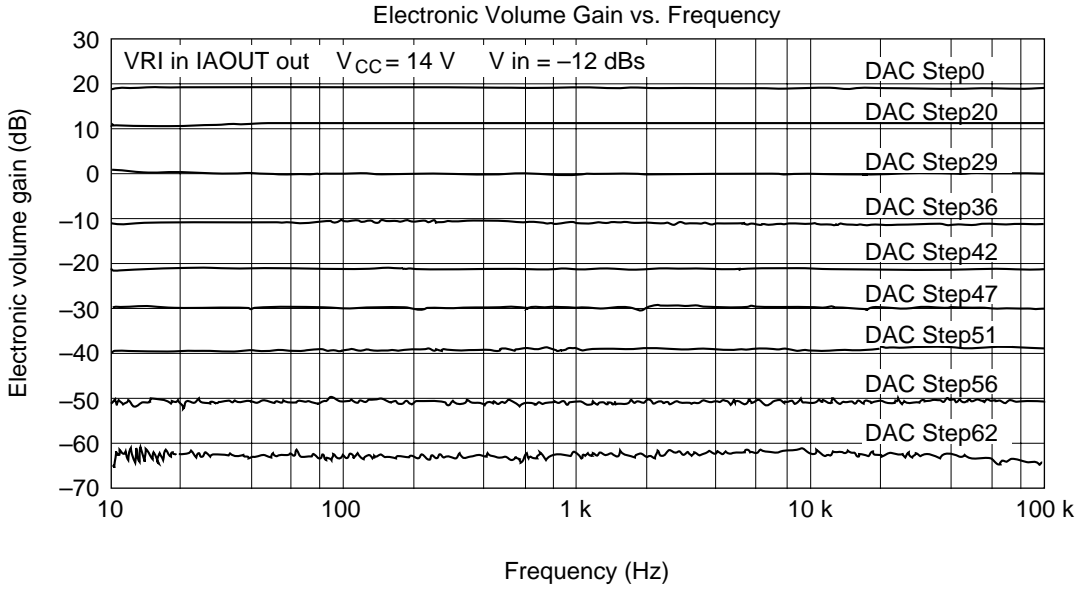

Level Meter Output vs. Input Level (HA12155)

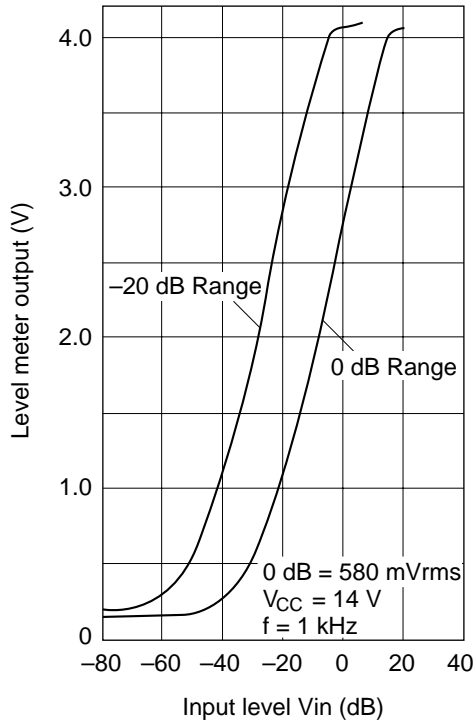

Level Meter Output vs. Input Level (HA12157)

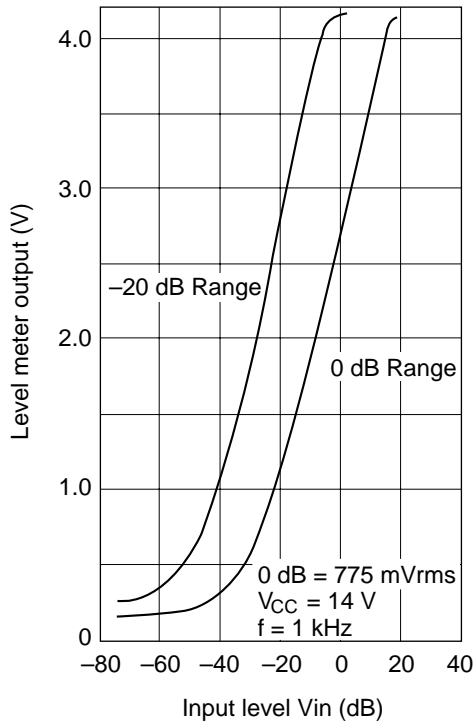

Level Meter Output vs. Frequency

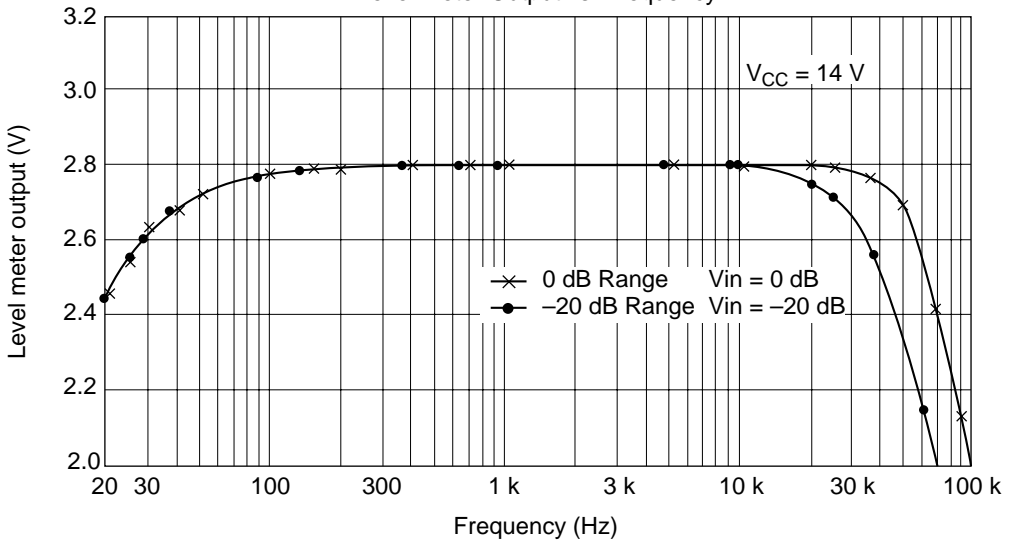

Level Meter Output vs. Supply Voltage

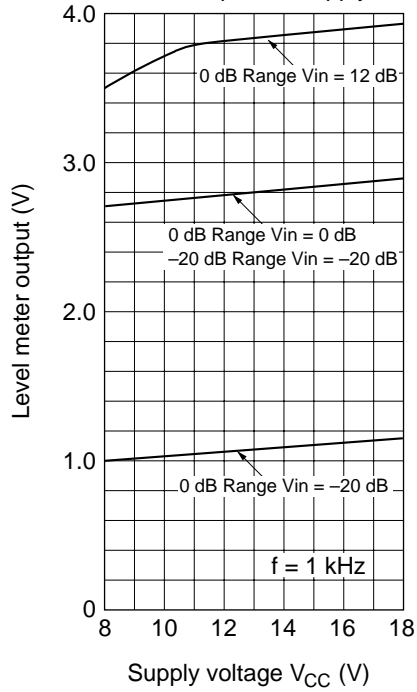

Equalizer Gain vs. Frequency

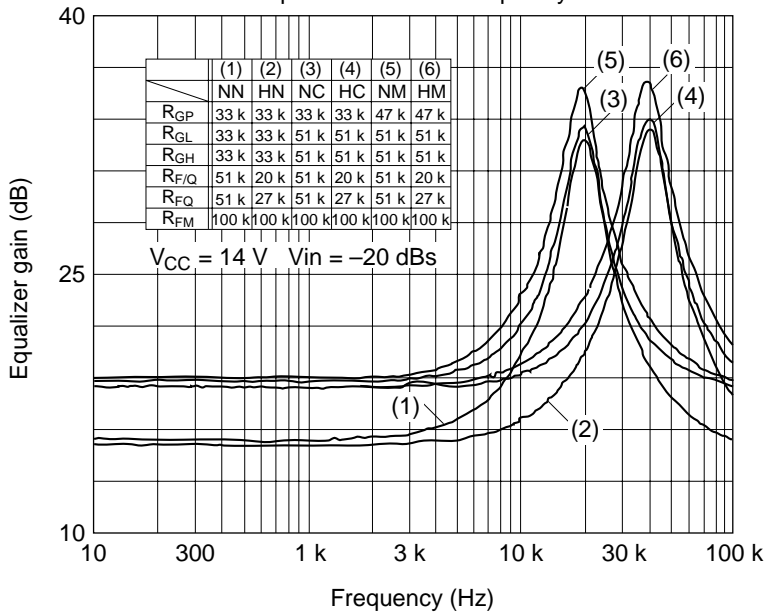

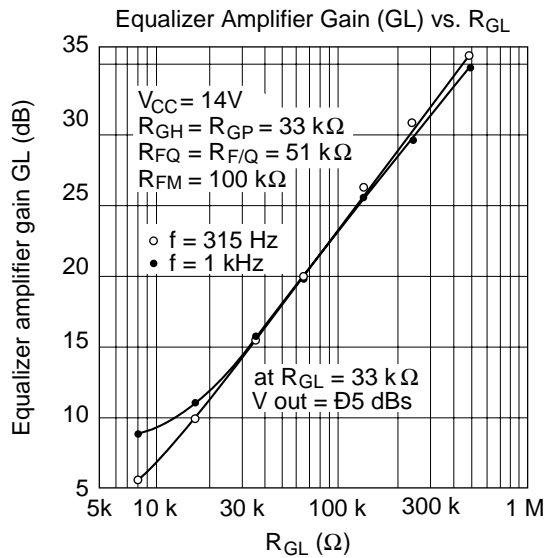
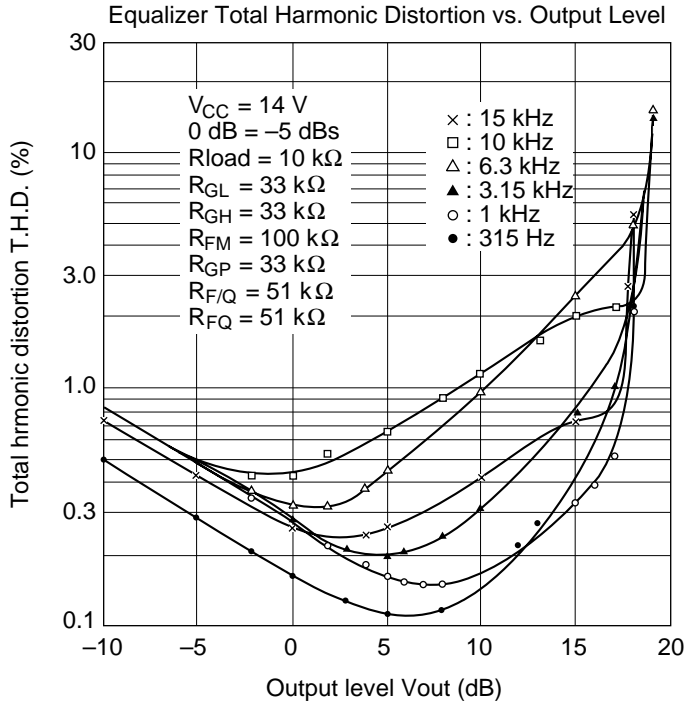

Equalizer Amplifier Gain (GH) vs. R_{GH}

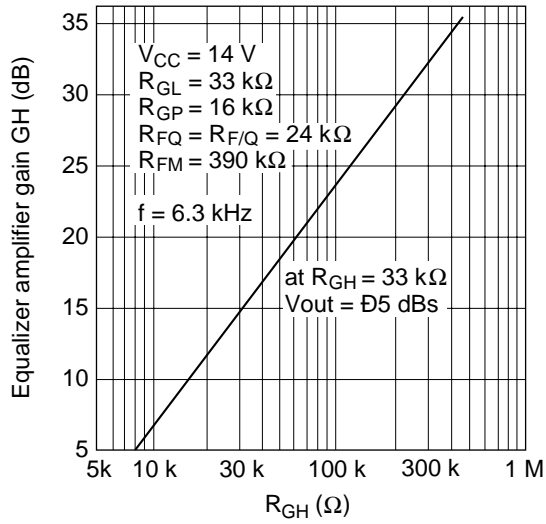

Equalizer Amplifier Gain (GP) vs. R_{GP}

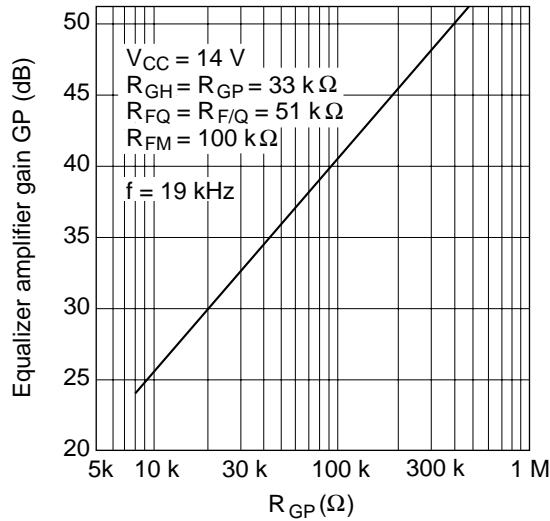

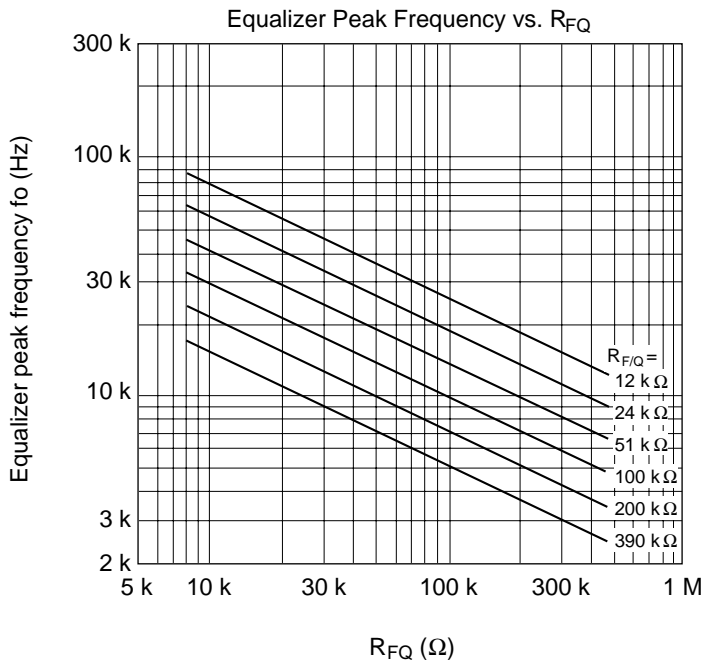
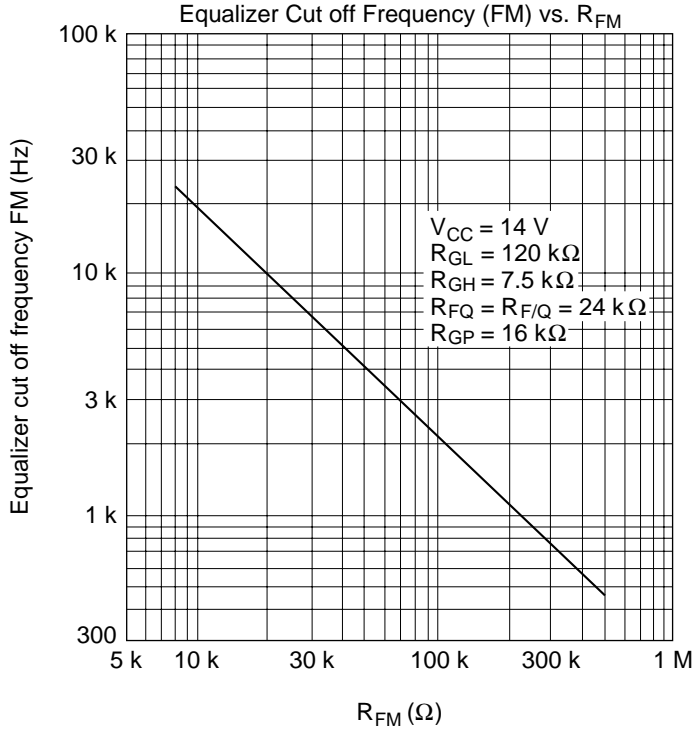

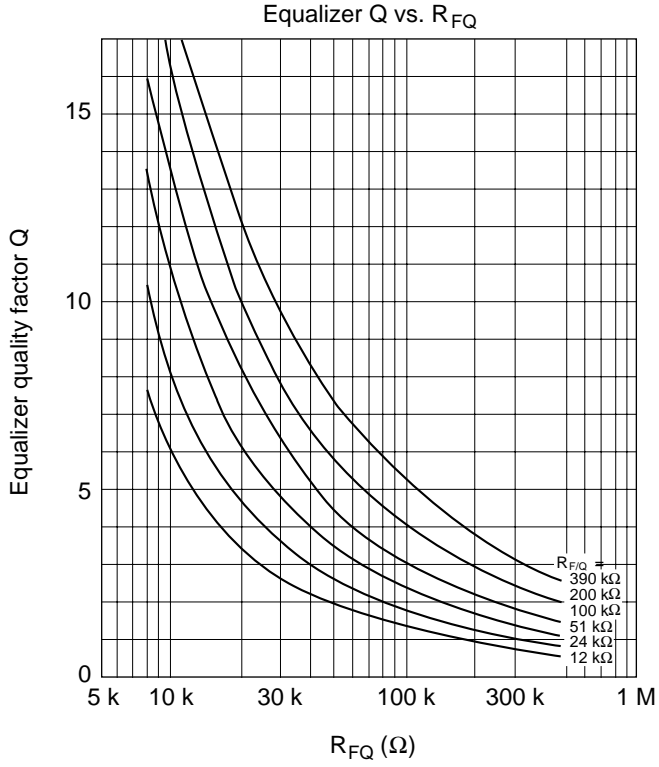

HA12155NT/HA12157NT

Package Dimensions

Unit: mm

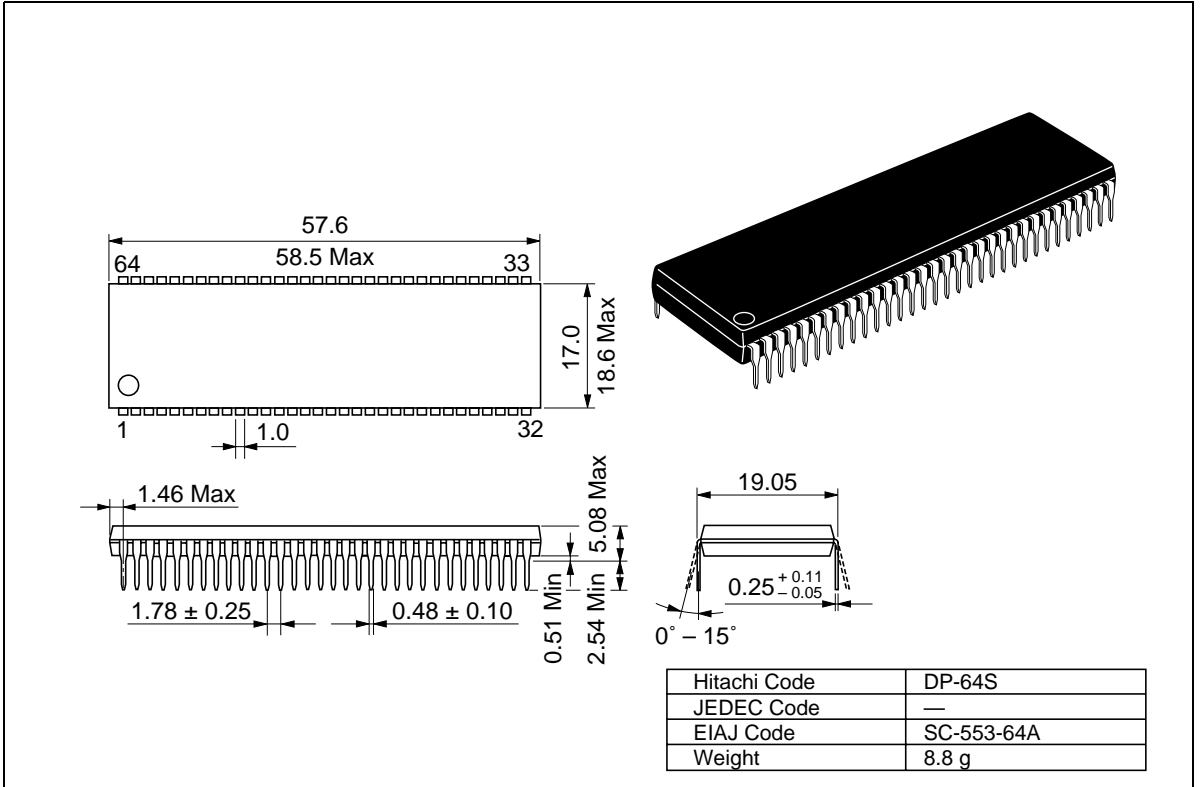

Disclaimer

1. Hitachi neither warrants nor grants licenses of any rights of Hitachi's or any third party's patent, copyright, trademark, or other intellectual property rights for information contained in this document. Hitachi bears no responsibility for problems that may arise with third party's rights, including intellectual property rights, in connection with use of the information contained in this document.
2. Products and product specifications may be subject to change without notice. Confirm that you have received the latest product standards or specifications before final design, purchase or use.
3. Hitachi makes every attempt to ensure that its products are of high quality and reliability. However, contact Hitachi's sales office before using the product in an application that demands especially high quality and reliability or where its failure or malfunction may directly threaten human life or cause risk of bodily injury, such as aerospace, aeronautics, nuclear power, combustion control, transportation, traffic, safety equipment or medical equipment for life support.
4. Design your application so that the product is used within the ranges guaranteed by Hitachi particularly for maximum rating, operating supply voltage range, heat radiation characteristics, installation conditions and other characteristics. Hitachi bears no responsibility for failure or damage when used beyond the guaranteed ranges. Even within the guaranteed ranges, consider normally foreseeable failure rates or failure modes in semiconductor devices and employ systemic measures such as fail-safes, so that the equipment incorporating Hitachi product does not cause bodily injury, fire or other consequential damage due to operation of the Hitachi product.
5. This product is not designed to be radiation resistant.
6. No one is permitted to reproduce or duplicate, in any form, the whole or part of this document without written approval from Hitachi.
7. Contact Hitachi's sales office for any questions regarding this document or Hitachi semiconductor products.

Sales Offices

HITACHI

Hitachi, Ltd.

Semiconductor & Integrated Circuits.
 Nippon Bldg., 2-6-2, Ohte-machi, Chiyoda-ku, Tokyo 100-0004, Japan
 Tel: Tokyo (03) 3270-2111 Fax: (03) 3270-5109

URL NorthAmerica : <http://semiconductor.hitachi.com/>
 Europe : <http://www.hitachi-eu.com/hel/ecg>
 Asia : <http://sicapac.hitachi-asia.com>
 Japan : <http://www.hitachi.co.jp/Sicd/indx.htm>

For further information write to:

Hitachi Semiconductor
 (America) Inc.
 179 East Tasman Drive,
 San Jose, CA 95134
 Tel: <1>(408) 433-1990
 Fax: <1>(408) 433-0223

Hitachi Europe GmbH
 Electronic Components Group
 Dornacher Straße 3
 D-85622 Feldkirchen, Munich
 Germany
 Tel: <49> (89) 9 9180-0
 Fax: <49> (89) 9 29 30 00

 Hitachi Europe Ltd.
 Electronic Components Group.
 Whitebrook Park
 Lower Cookham Road
 Maidenhead
 Berkshire SL6 8YA, United Kingdom
 Tel: <44> (1628) 585000
 Fax: <44> (1628) 585160

Hitachi Asia Ltd.
 Hitachi Tower
 16 Collyer Quay #20-00,
 Singapore 049318
 Tel : <65>-538-6533/538-8577
 Fax : <65>-538-6933/538-3877
 URL : <http://www.hitachi.com.sg>

Hitachi Asia Ltd.
 (Taipei Branch Office)
 4/F, No. 167, Tun Hwa North Road,
 Hung-Kuo Building,
 Taipei (105), Taiwan
 Tel : <886>-(2)-2718-3666
 Fax : <886>-(2)-2718-8180
 Telex : 23222 HAS-TP
 URL : <http://www.hitachi.com.tw>

Hitachi Asia (Hong Kong) Ltd.
 Group III (Electronic Components)
 7/F., North Tower,
 World Finance Centre,
 Harbour City, Canton Road
 Tsim Sha Tsui, Kowloon,
 Hong Kong
 Tel : <852>-(2)-735-9218
 Fax : <852>-(2)-730-0281
 URL : <http://www.hitachi.com.hk>

Copyright © Hitachi, Ltd., 2000. All rights reserved. Printed in Japan.
 Colophon 2.0