

## 31.0 dB, DC-4GHz, 5 Bit Serial Digital Attenuator

### Features

- Very Low DC Power Consumption
- Attenuation In Steps From 1 dB To 31 dB
- Single Or Dual Power Supply Voltages
- Serial Data Interface
- 50 Ohm Compatible Impedance
- Space Saving LPCC™ Surface Mount Packaging

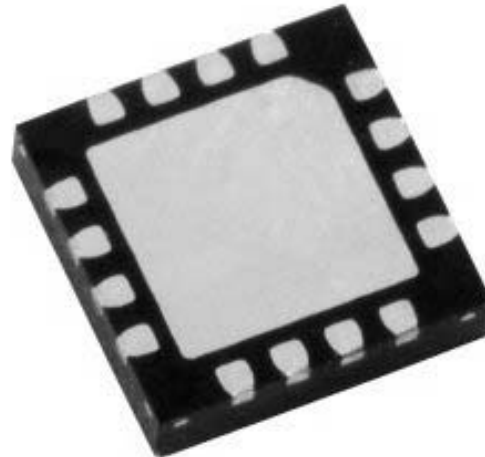

HRF-AT4521 in LPCC™ Package

### Product Description

The Honeywell HRF-AT4521 is a 5-bit digital attenuator that is ideal for use in broadband communication system applications that require accuracy, speed and low power consumption. The HRF-AT4521 is manufactured with Honeywell's patented Silicon On Insulator (SOI) CMOS manufacturing technology, which provides the performance of GaAs with the economy and integration capabilities of conventional CMOS.

### RF Electrical Specifications @ + 25°C

Parameter	Test Condition	Frequency	Minimum	Typical	Maximum	Units
Insertion Loss		DC – 0.5 GHz		1.8		dB
		2.0 GHz		2.8		dB
		3.0 GHz		--		dB
		4.0 GHz		--		dB
1dB Compression	VSS = 0V, Input Power	DC – 2.0 GHz		24		dBm
1dB Compression	VSS = - VDD, Input Power	DC – 2.0 GHz		29		dBm
Input IP3	VSS = 0V Two-tone inputs Up To +5 dBm @ 0 dBm Attenuation	DC – 2.0 GHz		38		dBm
Input IP3	V <sub>ss</sub> = - V <sub>DD</sub> Two-tone inputs Up To + 5 dBm @ 0 dBm Attenuation	DC – 2.0 GHz		>38		dBm
Return Loss*	Any Combination of Bits	DC - 4.0 GHz		11		dB
Attenuation Accuracy	All attenuation states	DC – 1.0 GHz	+/- (0.3 + 3% of programmed IL)			dB
		2.0 GHz	+/- (0.3 + 3% of programmed IL)			dB
		3.0 GHz	+/- (0.4 + 4% of programmed IL)			dB
		4.0 GHz	+/- (0.5 + 6% of programmed IL)			dB
Trise, Tfall* Ton, Toff (Tpd) Transients	10% To 90% 50% Cntl To 90%/10%RF In-Band			TBD		nS nS mV
T clock Period (Tprd)*	T high / T low = ½ minimum clock period		50			nS
T data set up (Tsup)*	Set up to rising edge of clock		5			nS
T data hold (Thld)*	Data hold after rising edge of clock		2			nS
T latch set up (Tlsup)*	Data set up to falling edge of OE		5			nS

0.01uF Decoupling Capacitors Required On Power Supply Rails.

\*By design

Web Site: [www.mysoiservices.com](http://www.mysoiservices.com)  
Email: [mysoiservices@honeywell.com](mailto:mysoiservices@honeywell.com)

## Functional Schematic

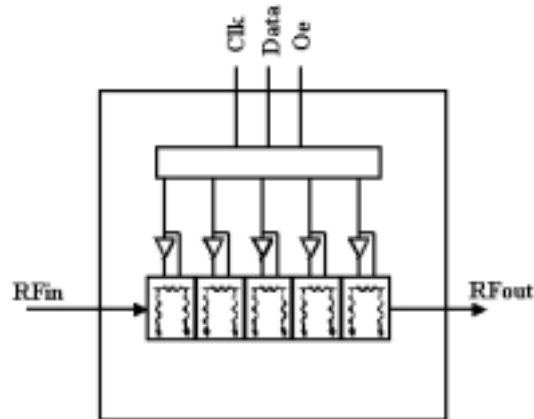

## DC Electrical Specifications @ + 25°C

Parameter	Minimum	Typical	Maximum	Units
$V_{DD}$	3.3 <sup>1</sup>	5.0		V
$V_{SS}$			-5.0	V
$I_{DD}$ Power Supply Current			2	mA
CMOS Logic level (0)	0		0.8	V
CMOS Logic level (1)	$V_{DD} - 0.8$		$V_{DD}$	V
Input Leakage Current			10	uA

Note 1, the performance curves are for  $V_{DD} = +5.0 \pm 10\%$

## Absolute Maximum Ratings<sup>2</sup>

Parameter	Absolute Maximum	Units
Input Power	+ 35	dBm
$V_{DD}$	+6.0	V
$V_{SS}$	-5.5	V
ESD Voltage	400	V
Operating Temperature	-40 To +85	Degrees C
Storage Temperature	-65 To +125	Degrees C
Digital Inputs	$V_{DD} + 0.6$ max to $V_{SS} - 0.6$ min	V

Note 2) Operation of this Device beyond any of these parameters may cause permanent damage.

**Latch-Up:** Unlike conventional CMOS digital attenuators, Honeywells' HRF-AT4521 is immune to latch-up.

**ESD Protection:** Although the HRF-AT4521 contains ESD protection circuitry on all digital inputs, conventional precautions should be taken to ensure that the Absolute Maximum Ratings are not exceeded.

Web Site: [www.mysoiservices.com](http://www.mysoiservices.com)  
 Email: [mysoiservices@honeywell.com](mailto:mysoiservices@honeywell.com)

2002 4521W Published June 2002 Page 2

Honeywell  
 Solid State Electronics Center  
 12001 State Highway 55  
 Plymouth, Minnesota 55441-4799  
 1-800-323-8295

## Package Outline Drawing

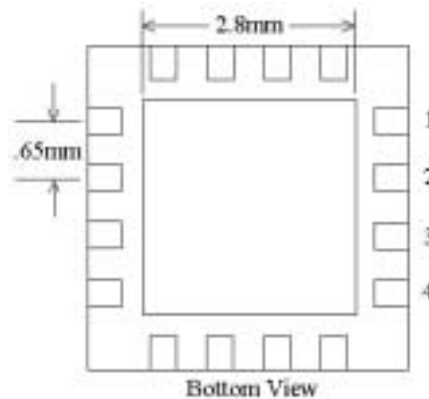

This package conforms to the LPCC<sup>™</sup> 4 x 4 mm 16 lead body dimensions. See ASAT LPCC Marketing Outline Dwg. # DGMJ00004 Latest Rev. at <http://www.asat.com> for additional dimensional information.

## Pin Configuration

Pin	Function	Pin	Function
1	VDD	9	GROUND
2	GROUND	10	RF OUTPUT
3	RF INPUT	11	GROUND
4	GROUND	12	VSS
5	GROUND	13	DIGITAL GROUND
6	GROUND	14	OE
7	GROUND	15	CLK
8	GROUND	16	DATA

## Serial Data Load

Serial data is shifted into the register on the rising edge of clock, MSB first. The OE falling edge must occur prior to any additional rising clock edges. See the Electrical Spec Table for AC parameters.

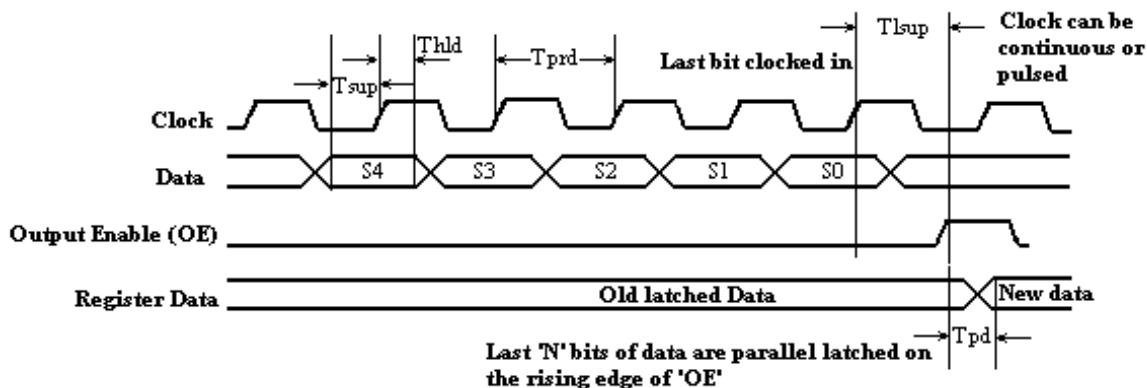

## Truth Table

S4	S3	S2	S1	S0	Output
0	0	0	0	0	Reference Input
0	0	0	0	1	1 dB
0	0	0	1	0	2 dB
0	0	1	0	0	4 dB
0	1	0	0	0	8 dB
1	0	0	0	0	16 dB
1	1	1	1	1	31 dB

## Evaluation Circuit Board

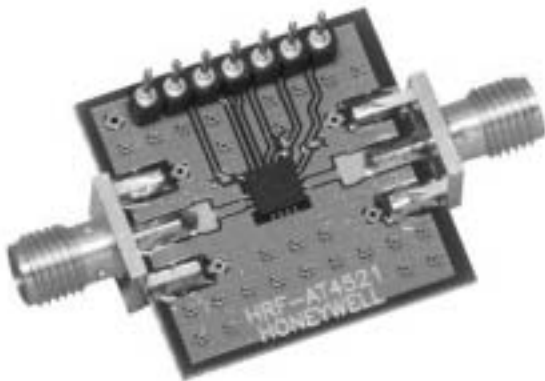

HRF-AT4521 Evaluation Board

Honeywell's evaluation board provides an easy to use method of evaluating the RF performance of our attenuator. Simply connect power, DC and RF signals to be measuring switch performance in less than 10 minutes.

## Evaluation Circuit Board Layout Design Details

Item	Description
PCB	Impedance Matched Multi-Layer FR4
Attenuator	HRF-AT4521 Digital Attenuator
Chip Capacitor	Panasonic Model ECU-E1C103KBQ Capacitor, .01uf 0402 10% 16V
RF Connector	Johnson Connectors Model 142-0701-801 SMA RF Coaxial Connector
DC Pin	Mil-Max Model 800-10-064-10-001 Header Pins

## Evaluation Circuit Board Connections

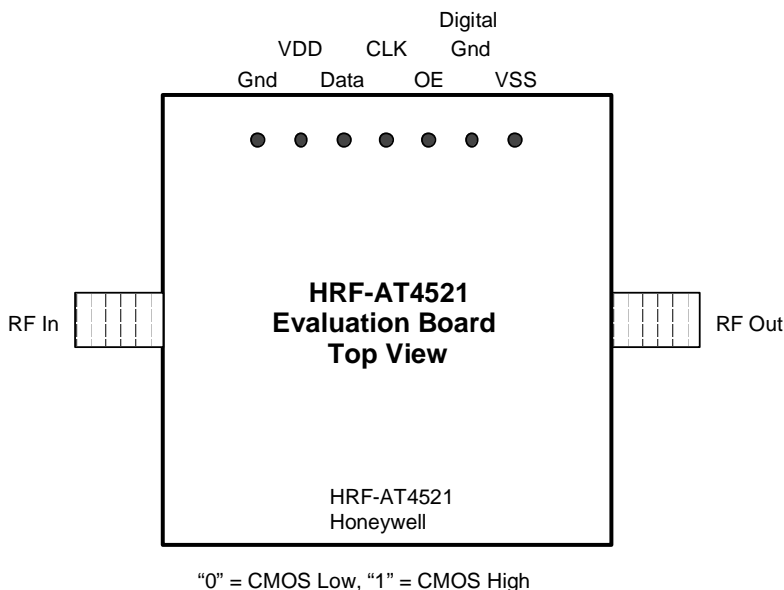

## Performance Curves

### Insertion Loss

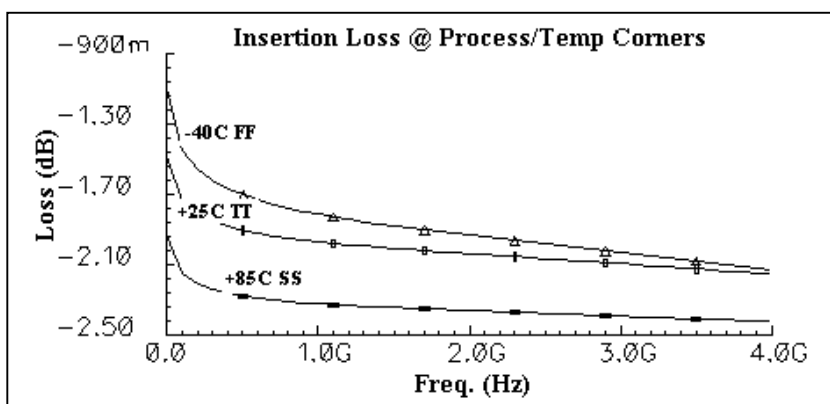

This Insertion Loss curve represents the Min/Max conditions for the "0" pass state versus all processing and temperature conditions. The Min case is at -40C with the "Fast" processing conditions. The Max case is at +85C with the "Slow" processing conditions. All other combinations fall within that band. The typical 25C case is labeled +25C TT.

## Return Loss

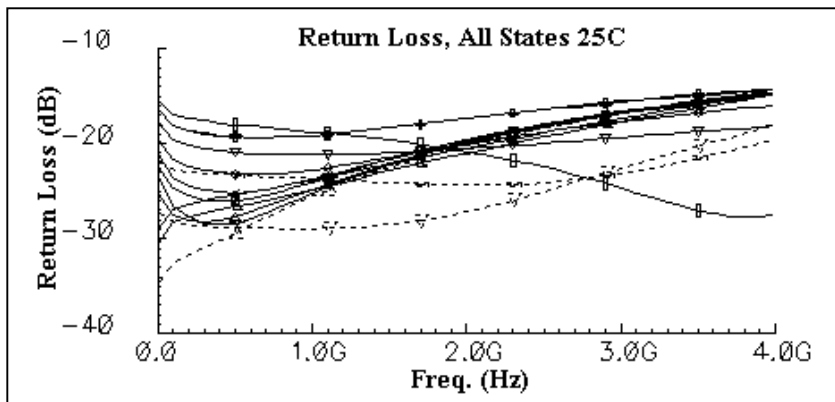

This Return Loss set of curves represents the combination of all Return Loss cases for all attenuation settings. All cases are better than  $-14\text{dB}$  Return Loss at 4GHz.

## Attenuation State Accuracy

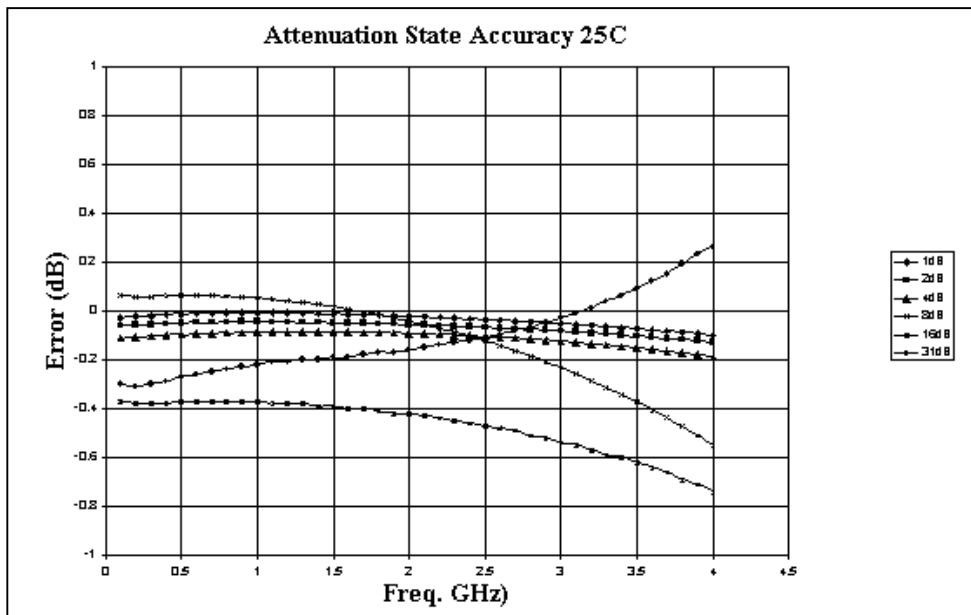

The Attenuation Accuracy curve with vertical axis of  $\pm 1\text{dB}$  shows all states better than  $\pm 0.5\text{dB}$  to 2GHz and better than  $\pm 0.8\text{dB}$  to 4GHz.

## Compression

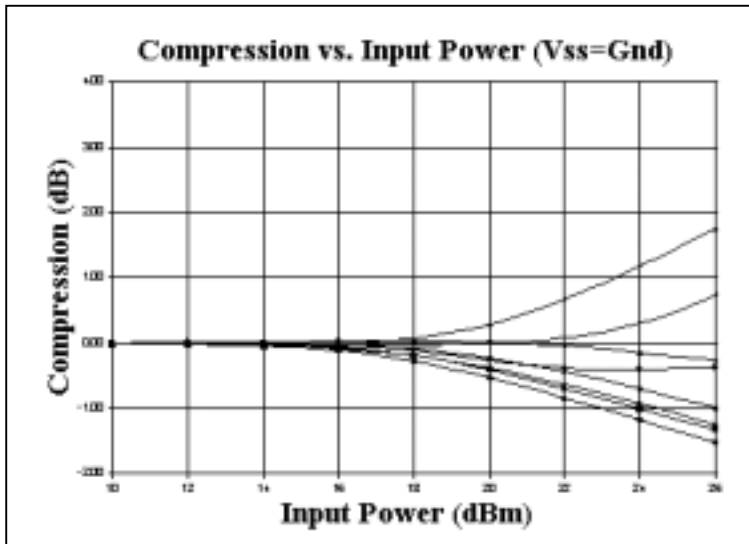

The P1dB curve shows all states with a P1dB compression at approximately 23dB input power. The conditions for this curve are Vdd = +5.0v and Vss = 0v. For higher P1dB compression values, supply Vss with a negative voltage as shown in the next curve.

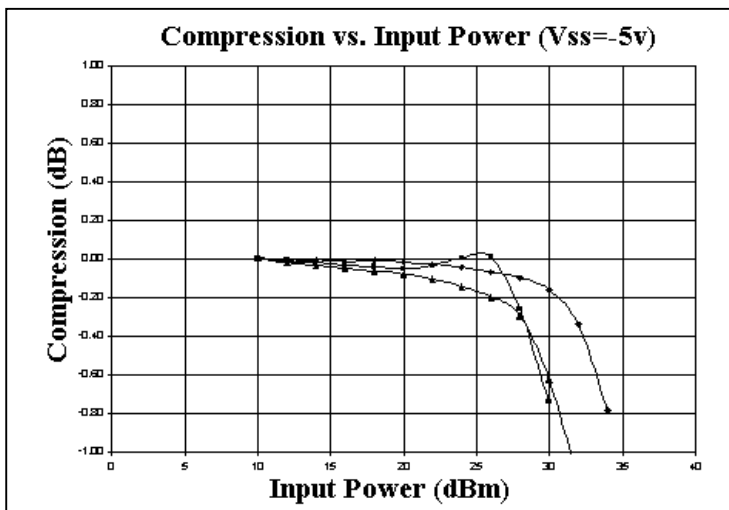

The P1dB curve shows all states with a P1dB compression at approximately 31dB input power. The conditions for this curve are Vdd = +5.0v and Vss = -5.0v.

## Ordering Information

Ordering Number	Delivery Method	Units Per Shipment
HRF-AT4521-B	In Chip Tubes	Customer Specific, Usually Minimum Of 50 Per Chip Tube
HRF-AT4521-TR HRF-AT4521-E	On Tape And Reel <sup>3</sup> On Individual Engineering Evaluation Board	Customer Specific One Board Per Box

(Note 3) Call Honeywell for details

LPCC™ is a registered Trademark of ASAT Ltd.

Honeywell reserves the right to make changes to improve reliability, function or design. Honeywell does not assume any liability arising out of the application or use of any product or circuit described herein; neither does it convey any license under its patent rights nor the rights of others.