

LS T670, LO T670, LY T670, LG T670, LP T670



Besondere Merkmale

- **Gehäusotyp:** weißes P-LCC-2-Gehäuse
- **Besonderheit des Bauteils:** extrem breite Abstrahlcharakteristik; ideal für Hinterleuchtungen und Einkopplungen in Lichtleiter
- **Wellenlänge:** 628 nm (super-rot), 605 nm (orange), 590 nm (gelb), 570 nm (grün), 560 nm (pure green)
- **Abstrahlwinkel:** Lambertischer Strahler (120°)
- **Technologie:** GaAIP (super-rot, orange, gelb, grün), GaP (pure green)
- **optischer Wirkungsgrad:** 1,5 lm/W (super-rot, orange, gelb), 2,5 lm/W (grün), 0,6 lm/W (pure green)
- **Gruppierungsparameter:** Lichtstärke
- **Verarbeitungsmethode:** für alle SMT-Bestücktechniken geeignet
- **Lötmethode:** IR Reflow Löten und Wellenlöten (TTW)
- **Vorbehandlung:** nach JEDEC Level 2
- **Gurtung:** 8-mm Gurt mit 2000/Rolle, ø180 mm oder 8000/Rolle, ø330 mm

Anwendungen

- Informationsanzeigen im Innen- und Außenbereich
- optischer Indikator
- Hinterleuchtung (LCD, Handy, Schalter, Tasten, Displays, Werbebeleuchtung, Allgemeinbeleuchtung)
- Innenbeleuchtung im Automobilbereich (z. B. Instrumentenbeleuchtung)
- Markierungsbeleuchtung (z.B. Stufen, Fluchtwege, u.ä.)
- Einkopplung in Lichtleiter
- Laufschriftanzeigen
- Signal- und Symbolleuchten

Features

- **package:** white P-LCC-2 package
- **feature of the device:** extremely wide viewing angle; ideal for backlighting and coupling in light guides
- **wavelength:** 628 nm (super-red), 605 nm (orange), 590 nm (yellow), 570 nm (green), 560 nm (pure green)
- **viewing angle:** Lambertian Emitter (120°)
- **technology:** GaAIP (super-red, orange, yellow, green), GaP (pure green)
- **optical efficiency:** 1.5 lm/W (super-red, orange, yellow), 2.5 lm/W (green), 0.6 lm/W (pure green)
- **grouping parameter:** luminous intensity
- **assembly methods:** suitable for all SMT assembly methods
- **soldering methods:** IR reflow soldering and TTW soldering
- **preconditioning:** acc. to JEDEC Level 2
- **taping:** 8-mm tape with 2000/reel, ø180 mm or 8000/reel, ø330 mm

Applications

- indoor and outdoor displays
- optical indicators
- backlighting (LCD, cellular phones, switches, keys, displays, illuminated advertising, general lighting)
- interior automotive lighting (e.g. dashboard backlighting)
- marker lights (e.g. steps, exit ways, etc.)
- coupling into light guides
- light writing displays
- signal and symbol luminaire

LS T670, LO T670, LY T670, LG T670, LP T670

Typ	Emissions- farbe	Farbe der Lichtaustritts- fläche	Lichtstärke	Lichtstrom	Bestellnummer
Type	Color of Emission	Color of the Light Emitting Area	Luminous Intensity $I_F = 10 \text{ mA}$ $I_V \text{ (mcd)}$	Luminous Flux $I_F = 10 \text{ mA}$ $\Phi_V \text{ (lm)}$	Ordering Code
LS T670-H2J2-1 LS T670-J2L1-1 LS T670-H2 LS T670-J1 LS T670-J2 LS T670-K1 LS T670-K2 LS T670-L1	super-red	colorless clear	3.55 ... 7.10 5.60 ... 14.00 3.55 ... 4.50 4.50 ... 5.60 5.60 ... 7.10 7.10 ... 9.00 9.00 ... 11.20 11.20 ... 14.00	15 (typ.) 28 (typ.) 12 (typ.) 15 (typ.) 19 (typ.) 24 (typ.) 30 (typ.) 40 (typ.)	Q62703-Q5094 Q62703-Q5095
LO T670-J1K1-1 LO T670-K1L2-1 LO T670-J1 LO T670-J2 LO T670-K1 LO T670-K2 LO T670-L1 LO T670-L2	orange	colorless clear	4.50 ... 9.00 7.10 ... 18.00 4.50 ... 5.60 5.60 ... 7.10 7.10 ... 9.00 9.00 ... 11.20 11.20 ... 14.00 14.00 ... 18.00	20 (typ.) 36 (typ.) 15 (typ.) 19 (typ.) 24 (typ.) 30 (typ.) 40 (typ.) 50 (typ.)	Q62703-Q5046 Q62703-Q5047
LY T670-J1K1-1 LY T670-K1L2-1 LY T670-J1 LY T670-J2 LY T670-K1 LY T670-K2 LY T670-L1 LY T670-L2	yellow	colorless clear	4.50 ... 9.00 7.10 ... 18.00 4.50 ... 5.60 5.60 ... 7.10 7.10 ... 9.00 9.00 ... 11.20 11.20 ... 14.00 14.00 ... 18.00	20 (typ.) 36 (typ.) 15 (typ.) 19 (typ.) 24 (typ.) 30 (typ.) 40 (typ.) 50 (typ.)	Q62703-Q5132 Q62703-Q5133
LG T670-K1L1-1 LG T670-L1M2-1 LG T670-K1 LG T670-K2 LG T670-L1 LG T670-L2 LG T670-M1 LG T670-M2	green	colorless clear	7.10 ... 14.00 11.20 ... 28.00 7.10 ... 9.00 9.00 ... 11.20 11.20 ... 14.00 14.00 ... 18.00 18.00 ... 22.40 22.40 ... 28.00	31 (typ.) 56 (typ.) 24 (typ.) 30 (typ.) 40 (typ.) 50 (typ.) 60 (typ.) 75 (typ.)	Q62703-Q5010 Q62703-Q5011

LS T670, LO T670, LY T670, LG T670, LP T670

Typ	Emissions- farbe	Farbe der Lichtaustritts- fläche	Lichtstärke	Lichtstrom	Bestellnummer
Type	Color of Emission	Color of the Light Emitting Area	Luminous Intensity $I_F = 10 \text{ mA}$ $I_V \text{ (mcd)}$	Luminous Flux $I_F = 10 \text{ mA}$ $\Phi_V \text{ (mlm)}$	Ordering Code
LP T670-G1H1-1	pure green	colorless clear	1.80 ... 3.55	8.0 (typ.)	Q62703-Q5064
LP T670-H1J2-1			2.80 ... 7.10	14.0 (typ.)	Q62703-Q5065
LP T670-G1			1.80 ... 2.24	6.0 (typ.)	
LP T670-G2			2.24 ... 2.80	7.6 (typ.)	
LP T670-H1			2.80 ... 3.55	8.5 (typ.)	
LP T670-H2			3.55 ... 4.50	12.0 (typ.)	
LP T670-J1			4.50 ... 5.60	15.0 (typ.)	
LP T670-J2			5.60 ... 7.10	19.0 (typ.)	

Helligkeitswerte werden mit einer Stromeinprägedauer von 25 ms und einer Genauigkeit von $\pm 11 \%$ ermittelt.

Luminous intensity is tested at a current pulse duration of 25 ms and an accuracy of $\pm 11 \%$.

Grenzwerte
Maximum Ratings

Bezeichnung Parameter	Symbol Symbol	Wert Value		Einheit Unit
		LS, LO, LY, LG	LP	
Betriebstemperatur Operating temperature range	T_{op}	- 40 ... + 100		°C
Lagertemperatur Storage temperature range	T_{stg}	- 40 ... + 100		°C
Sperrschichttemperatur Junction temperature	T_j	+ 100		°C
Durchlassstrom Forward current	I_F	30		mA
Stoßstrom Surge current $t \leq 10 \mu s, D = 0.005$	I_{FM}	0.5		A
Sperrspannung Reverse voltage	V_R	5		V
Leistungsaufnahme Power dissipation	P_{tot}	95	90	mW
Wärmewiderstand Thermal resistance Sperrschicht/Umgebung Junction/ambient	$R_{th JA}$	400		K/W
Sperrschicht/Lötpad Junction/soldering point Montage auf PC-Board FR 4 (Padgröße $\geq 16 \text{ mm}^2$) mounted on PC board FR 4 (pad size $\geq 16 \text{ mm}^2$)	$R_{th JS}$	180		K/W

Kennwerte ($T_A = 25\text{ °C}$)

Characteristics

Bezeichnung Parameter	Symbol Symbol	Wert Value					Einheit Unit
		LS	LO	LY	LG	LP	
Wellenlänge des emittierten Lichtes Wavelength at peak emission $I_F = 10\text{ mA}$	(typ.) λ_{peak}	635	610	586	565	557	nm
Dominantwellenlänge Dominant wavelength $I_F = 10\text{ mA}$	(typ.) λ_{dom}	628	605	590	570	560	nm
Spektrale Bandbreite bei 50 % $I_{\text{rel max}}$ Spectral bandwidth at 50 % $I_{\text{rel max}}$ $I_F = 10\text{ mA}$	(typ.) $\Delta\lambda$	45	40	45	25	22	nm
Abstrahlwinkel bei 50 % I_V (Vollwinkel) Viewing angle at 50 % I_V	(typ.) 2ϕ	120	120	120	120	120	Grad deg.
Durchlassspannung Forward voltage $I_F = 10\text{ mA}$	(typ.) V_F (max.) V_F	2.0 2.6	2.0 2.6	2.0 2.6	2.0 2.6	2.0 2.6	V V
Sperrstrom Reverse current $V_R = 5\text{ V}$	(typ.) I_R (max.) I_R	0.01 10	0.01 10	0.01 10	0.01 10	0.01 10	μA μA
Temperaturkoeffizient von λ_{peak} Temperature coefficient of λ_{peak} $I_F = 10\text{ mA}$	(typ.) $TC_{\lambda_{\text{peak}}}$	0.11	0.12	0.10	0.11	0.11	nm/K
Temperaturkoeffizient von λ_{dom} Temperature coefficient of λ_{dom} $I_F = 10\text{ mA}$	(typ.) $TC_{\lambda_{\text{dom}}}$	0.07	0.07	0.07	0.07	0.05	nm/K
Temperaturkoeffizient von V_F Temperature coefficient of V_F $I_F = 10\text{ mA}$	(typ.) TC_V	-1.9	-1.9	-1.9	-1.4	-2.1	mV/K
Optischer Wirkungsgrad Optical efficiency $I_F = 10\text{ mA}$	(typ.) η_{opt}	1.5	1.5	1.5	2.5	0.6	lm/W

Relative spektrale Emission $I_{rel} = f(\lambda)$, $T_A = 25\text{ }^\circ\text{C}$, $I_F = 10\text{ mA}$

Relative Spectral Emission

$V(\lambda)$ = spektrale Augenempfindlichkeit

Standard eye response curve

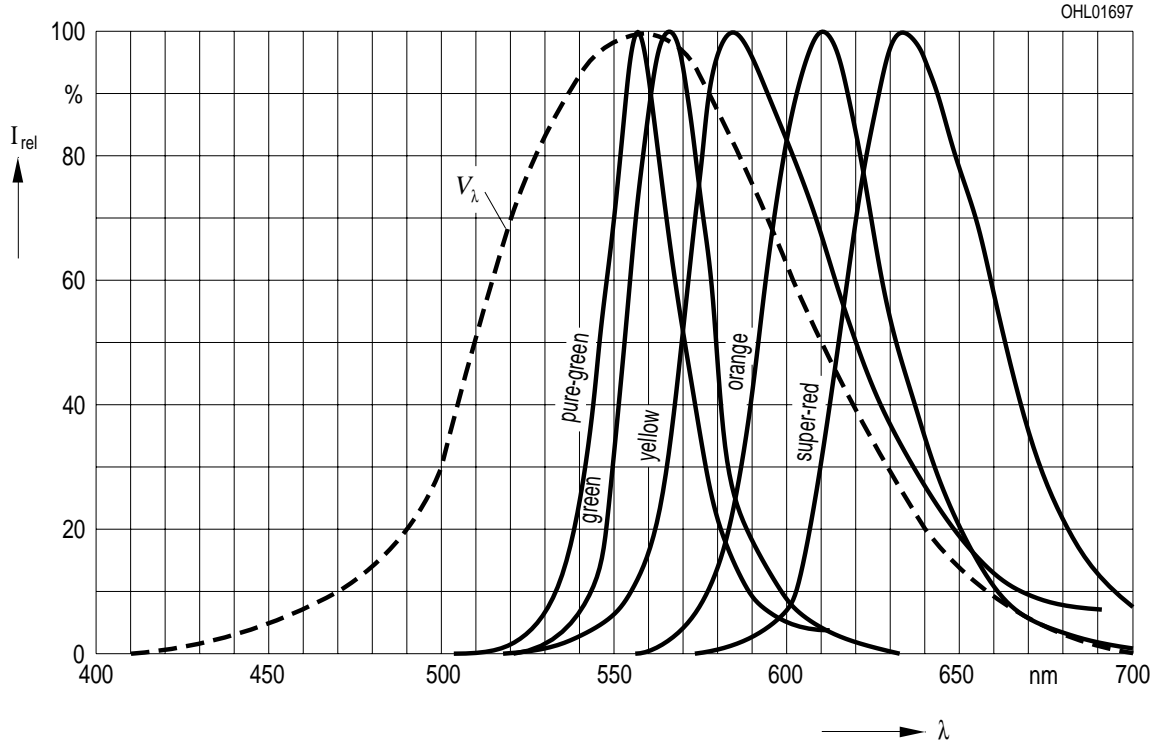

Abstrahlcharakteristik $I_{rel} = f(\varphi)$

Radiation Characteristic

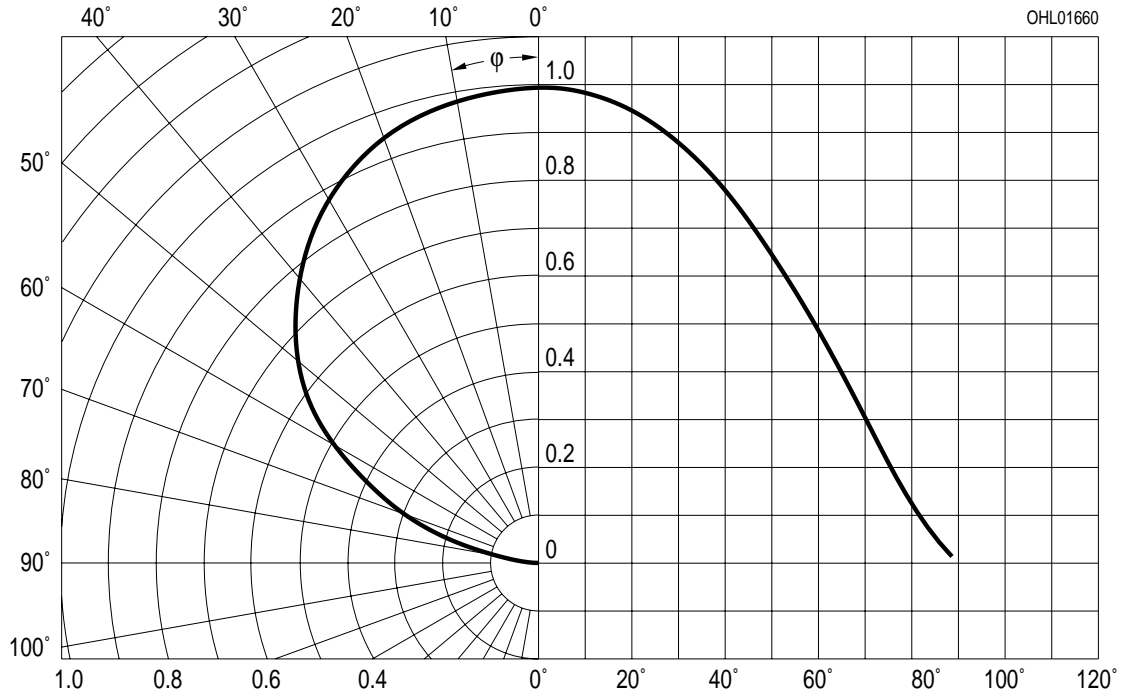

Durchlassstrom $I_F = f(V_F)$

Forward Current

$T_A = 25\text{ }^\circ\text{C}$

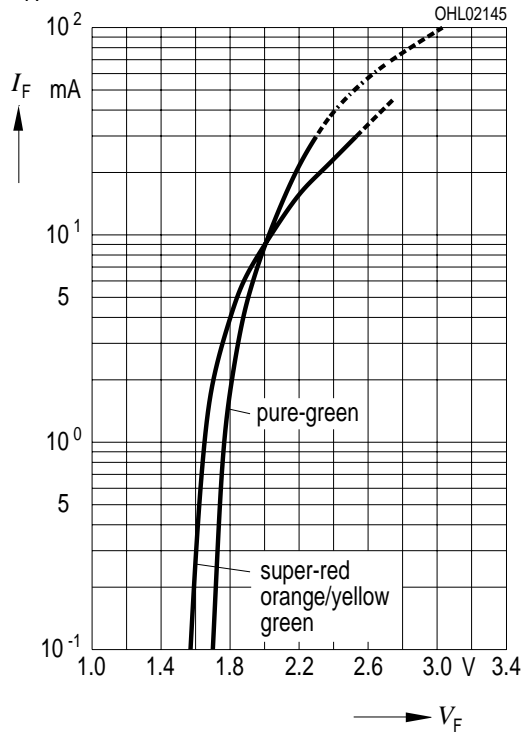

Relative Lichtstärke $I_V / I_{V(10\text{ mA})} = f(I_F)$

Relative Luminous Intensity

$T_A = 25\text{ }^\circ\text{C}$

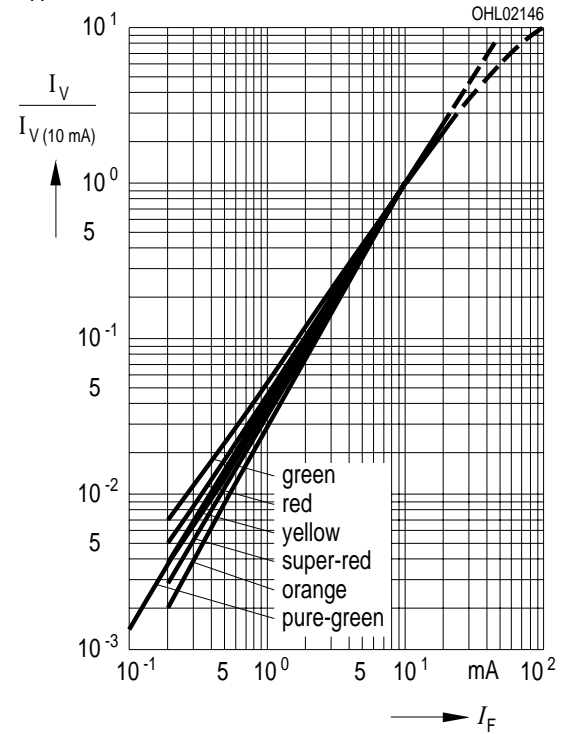

Maximal zulässiger Durchlassstrom $I_F = f(T_A)$

Max. Permissible Forward Current

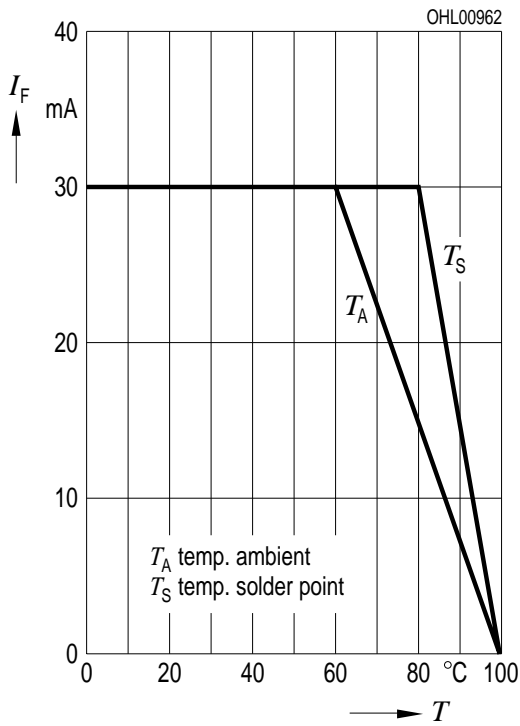

Relative Lichtstärke $I_V / I_{V(25\text{ }^\circ\text{C})} = f(T_A)$

Relative Luminous Intensity

$I_F = 10\text{ mA}$

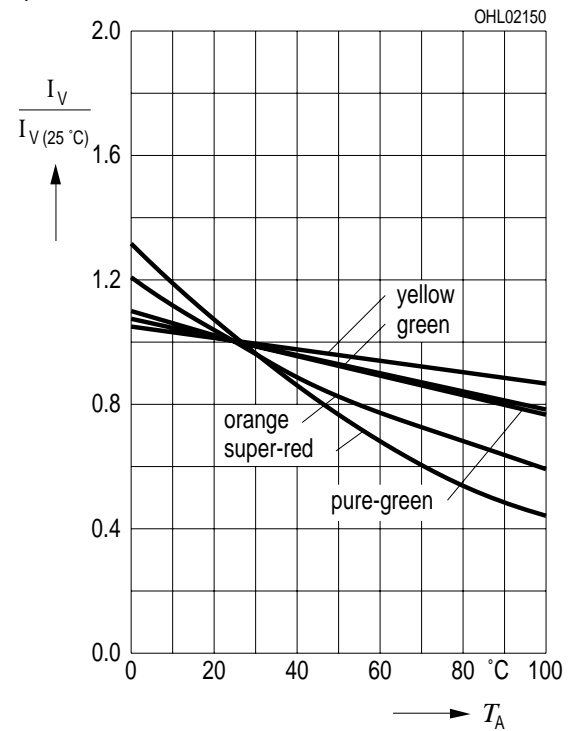

Zulässige Impulsbelastbarkeit $I_F = f(t_p)$
Permissible Pulse Handling Capability
 Duty cycle $D =$ parameter, $T_A = 25\text{ °C}$

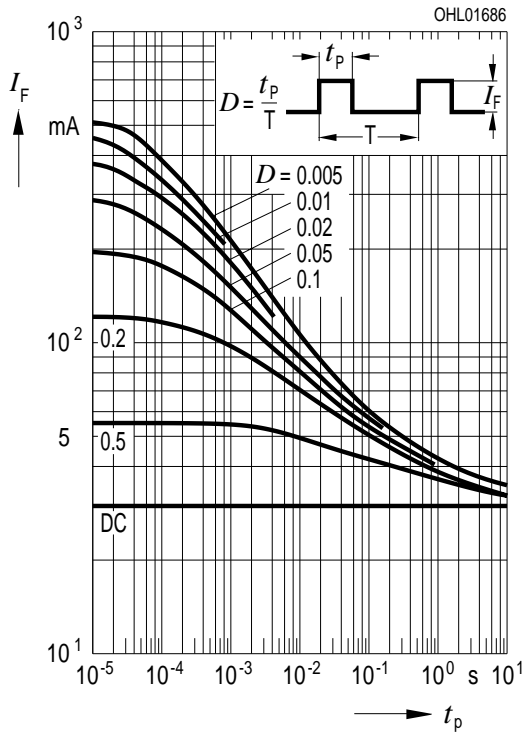

Maßzeichnung
Package Outlines

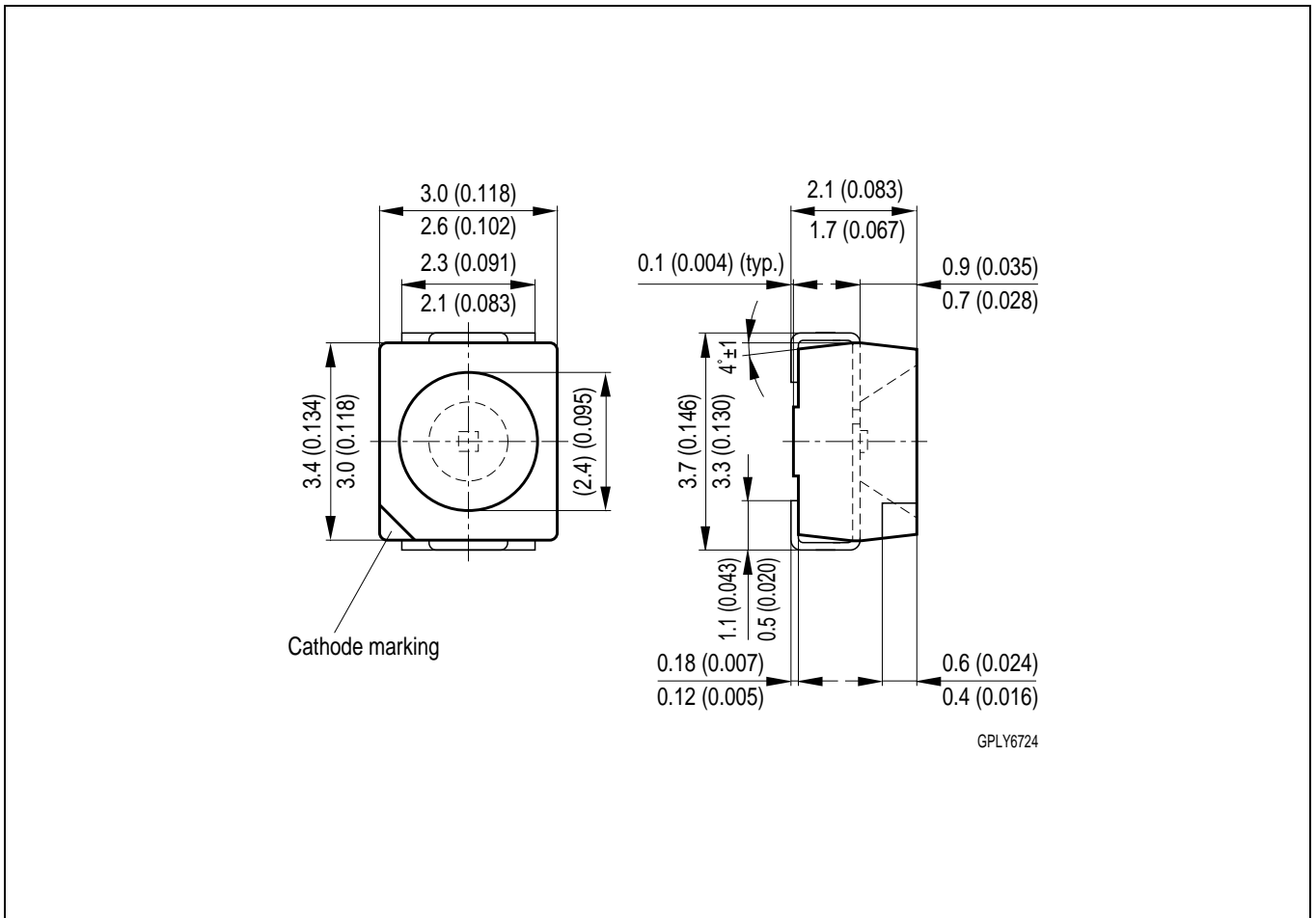

Maße werden wie folgt angegeben: mm (inch) / Dimensions are specified as follows: mm (inch).

Kathodenkennung: abgeschrägte Ecke
Cathode mark: bevelled edge

Lötbedingungen Vorbehandlung nach JEDEC Level 2
Soldering Conditions Preconditioning acc. to JEDEC Level 2

IR-Reflow Lötprofil (nach IPC 9501)
IR Reflow Soldering Profile (acc. to IPC 9501)

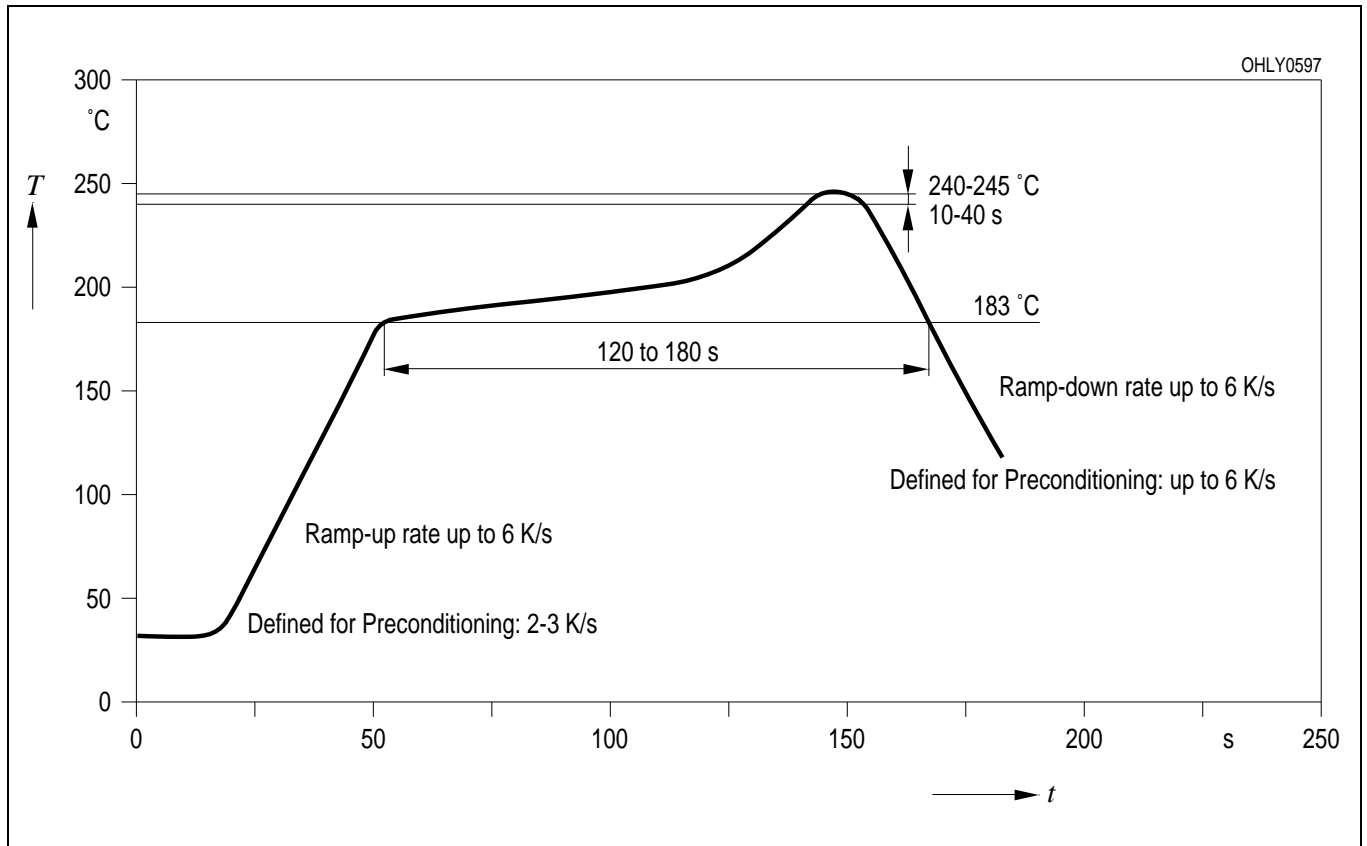

Wellenlötten (TTW) (nach CECC 00802)
TTW Soldering (acc. to CECC 00802)

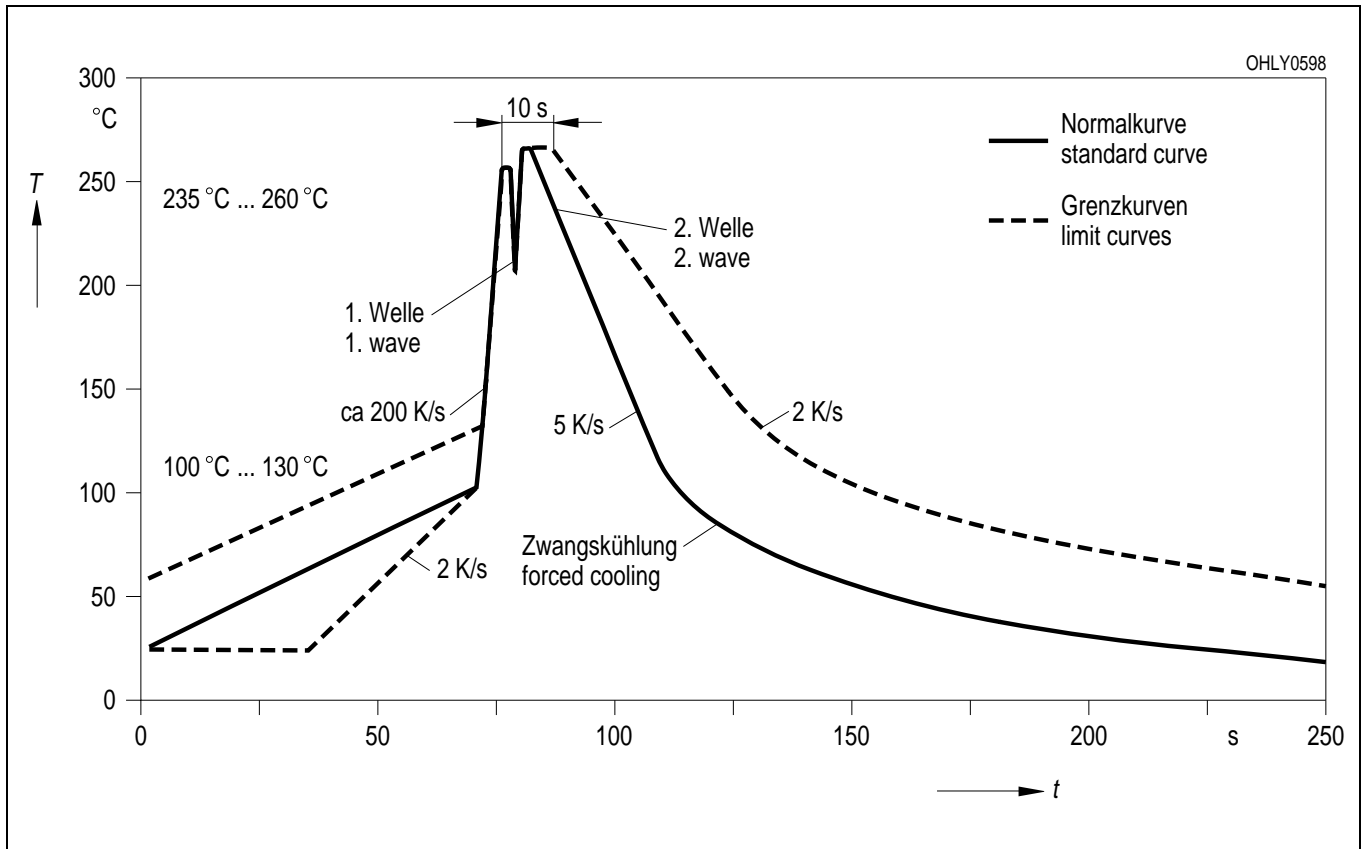

Empfohlenes Lötpad Design IR-Reflow Löten / Wellenlöten (TTW)
Recommended Solder Pad IR Reflow Soldering / TTW Soldering

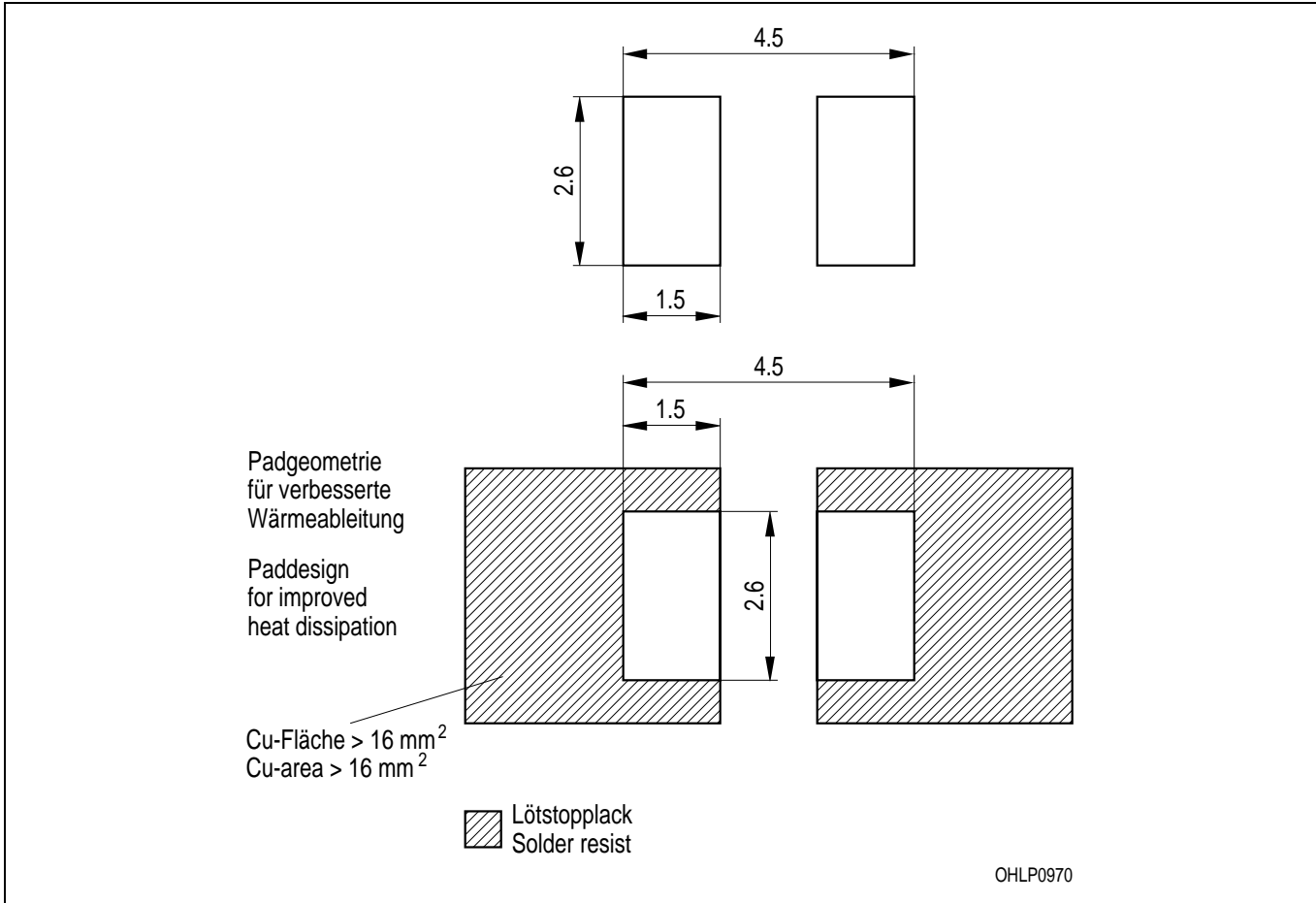

Gurtung / Polarität und Lage

Verpackungseinheit 2000/Rolle, ø180 mm oder 8000/Rolle, ø330 mm

Method of Taping / Polarity and Orientation

Packing unit 2000/reel, ø180 mm or 8000/reel, ø330 mm

