

SIEMENS



ICs for Consumer Electronics

SDA 525X to SDA 525X-2 V2.0

SDA 525X to SDA 525X-2		
Revision History:		Current Version: 1998-10-08
Previous Version:		1998-03-10
Page (in previous Version)	Page (in current Version)	Subjects (major changes since last revision)
-	15	“VS sampling” inserted
-	17	“RGB and blanking skew” inserted
4, 5	4, 5	SDA 5254-57-2 with 10 pages optional
4, 5	4, 5	Also SDA 5253-2 available
14	14	Hardware compatibility, topics 5 to 8 added
18	21	Timing changed to 18 MHz
19	22	Changes in application circuit (Iref, CVBS, FIL3)

Edition 1998-10-08

**Published by Siemens AG,
Bereich Halbleiter, Marketing-
Kommunikation, Balanstraße 73,
81541 München**

© Siemens AG 1998.
All Rights Reserved.

Attention please!

As far as patents or other rights of third parties are concerned, liability is only assumed for components, not for applications, processes and circuits implemented within components or assemblies.

The information describes the type of component and shall not be considered as assured characteristics.

Terms of delivery and rights to change design reserved.

For questions on technology, delivery and prices please contact the Semiconductor Group Offices in Germany or the Siemens Companies and Representatives worldwide (see address list).

Due to technical requirements components may contain dangerous substances. For information on the types in question please contact your nearest Siemens Office, Semiconductor Group.

Siemens AG is an approved CECC manufacturer.

Packing

Please use the recycling operators known to you. We can also help you – get in touch with your nearest sales office. By agreement we will take packing material back, if it is sorted. You must bear the costs of transport.

For packing material that is returned to us unsorted or which we are not obliged to accept, we shall have to invoice you for any costs incurred.

Components used in life-support devices or systems must be expressly authorized for such purpose!

Critical components¹ of the Semiconductor Group of Siemens AG, may only be used in life-support devices or systems² with the express written approval of the Semiconductor Group of Siemens AG.

- 1 A critical component is a component used in a life-support device or system whose failure can reasonably be expected to cause the failure of that life-support device or system, or to affect its safety or effectiveness of that device or system.
- 2 Life support devices or systems are intended (a) to be implanted in the human body, or (b) to support and/or maintain and sustain human life. If they fail, it is reasonable to assume that the health of the user may be endangered.

Table of Contents		Page
1	General Description	4
2	Complete Feature List Including New Features	4
3	Block Diagram	6
4	Pin Configuration	7
4.1	P-MQFP-80-1, ROMless-Version (top view)	7
4.2	P-LCC-84-2, Emulator-Version (top view)	8
4.3	P-SDIP-52-1, ROM-Versions (top view)	9
4.4	P-MQFP-64-1, ROM-Versions (top view)	10
5	Pin Correspondence	11
6	Differences of SDA 525x-2 Compared to SDA 525x	14
6.1	Hardware-Compatibility	14
6.2	Software-Compatibility	14
6.3	Improved Performance Sync- and Data-Slicer	14
6.4	Crystal-locked Display-PLL	14
6.5	Improved Interface to External RAM	14
6.6	No UART	15
6.7	VS Sampling	15
6.8	RGB and Blanking Skew	17
7	Registers of SDA 525x-2	18
7.1	Address Space of SDA 525x-2	20
8	Software Changes	21
9	Timing	21
10	Application Circuit	22

1 General Description

As its predecessors SDA 525x the SDA 525x-2 contains a slicer for VPS and TTX, an accelerating acquisition hardware module, a display generator for "Level 1.5" TTX data, and an 8 bit microcontroller running at 333 ns cycle time. The controller with dedicated hardware guarantees flexibility, does most of the internal processing of TTX acquisition, transfers data to/from the external memory interface and receives/transmits data via I²C user interface. The block diagram shows the internal organization of the SDA 525x-2. The slicer combined with dedicated hardware stores TTX data in a VBI buffer of 746 Byte. The microcontroller firmware performs all the acquisition tasks (hamming- and parity-checks, page search and evaluation of header control bits) once per field.

This delta specification describes the differences of the SDA 525x-2 compared to the SDA 525x as described in the preliminary data sheet 1997-09-01.

2 Complete Feature List Including *New Features*

New features compared to SDA 525x-Specification, version 06/96 are printed in *italic and bold*. As described in the errata sheet 03/97, release 1.0, the newer versions of the SDA 525x and the SDA 525x-2 will *not have a serial port (UART)* any more.

- **Acquisition:**

- Feature selection via special function register
- Simultaneous reception of TTX, VPS, and WSS
- Fixed framing code for VPS and TTX
- Acquisition during VBI
- Direct access to VBI RAM buffer
- Acquisition of packets x/26, x/27, 8/30 (firmware)
- Assistance of all relevant checks (firmware)
- 1-bit framing code error tolerance (switchable)

- **Display:**

- Features selectable via special function register
- 50/60 Hz display (*optional 100 Hz*)
- Level 1.5 serial attribute display pages
- Blanking and contrast reduction output
- 8 direct addressable display pages for SDA 5250-2, SDA 5254-2 to SDA 5257-2 (*optional 10 pages*)
- 1 direct addressable display page for SDA 5251-2 to SDA 5253-2
- 12 × 10 character matrix
- 96 character ROM (standard G0 character set)
- **156** national option characters for **12** languages (for European version)
- 288 characters for X/26 display
- 64 block mosaic graphic characters
- 32 characters for OSD in expanded character ROM + 32 characters inside OSD box

- Conceal/reveal
- Transparent foreground/background - inside/outside of a box
- Contrast reduction inside/outside of a box
- Cursor (color changes from foreground to background color)
- Flash (flash rate 1s, **not depending on field rate**)
- Programmable horizontal and vertical sync delay
- Full screen background color in outer screen
- Double size/double width/double height characters
- **Synchronization:**
 - Display synchronization to sandcastle or Horizontal Sync (HS) and Vertical Sync (VS)
- **Microcontroller:**
 - 8 bit C500-CPU (8051 compatible)
 - CPU-clock 18 MHz, **external 6-MHz-crystal**
 - 333 ns instruction cycle
 - Parallel 8-bit data and 16 ... 19-bit address bus (ROMless-Version)
 - Eight 16-bit data pointer registers (DPTR)
 - Two 16-bit timers
 - Watchdog timer
 - Capture compare timer for infrared remote control decoding
 - 256 bytes on-chip RAM
 - 8 KByte on-chip display-RAM (access via MOVX) SDA 5250-2, SDA 5254-2 to SDA 5257-2 (**optional 10 Kbyte**)
 - 1 Kbyte on-chip display-RAM (access via MOVX) for SDA 5251-2 to SDA 5253-2
 - 1 Kbyte on-chip ACQ-buffer-RAM (access via MOVX)
 - 1 Kbyte on-chip extended-RAM (access via MOVX) for SDA 5250-2 and SDA 5254-2 to SDA 5257-2
 - 6 channel 8-bit pulse width modulation unit
 - 2 channel 14-bit pulse width modulation unit
 - 4 multiplexed ADC inputs with 8-bit resolution
 - One 8-bit I/O port with open drain output and optional I²C-Bus emulation
 - Two 8-bit multifunctional I/O ports
 - One 4-bit port working as digital or analog inputs
 - One 3-bit I/O port with optional RAM/ROM address expansion up to 512 Kbyte (ROMless-Version)
- **P-SDIP-52-1/P-MQFP-64-1 package for ROM-Versions (SDA 5251-2 to SDA 5253-2, SDA 5254-2 to SDA 5257-2)**
- **P-MQFP-80-1 package for ROMless-Version (SDA 5250M-2)**
- **P-LCC-84-2 package for Emulator-Version (SDA 5250-2)**
- **5 V supply voltage**

3 Block Diagram

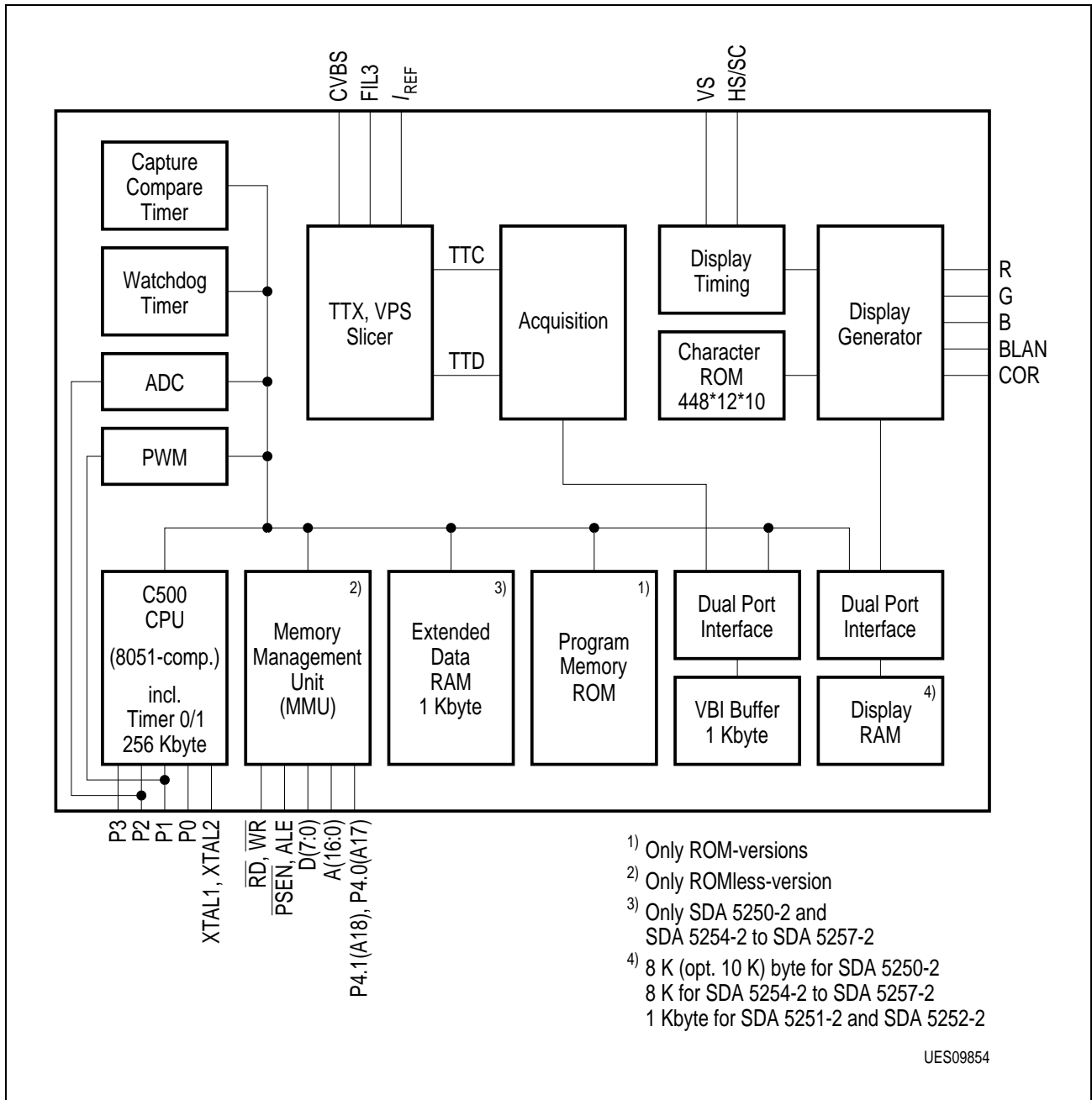

Figure 1

Differences compared to SDA 525x according to preliminary specification 06/96:

1. UART is not supported.
2. RGB-outputs deliver a current instead of a voltage.
3. Instead of FIL1SLC/FIL2SLC/FIL3SLC only FIL3 is needed with changed external device dimensions.
4. LCIN and LCOOUT are not needed any more.

4 Pin Configuration

4.1 P-MQFP-80-1, ROMless-Version (top view)

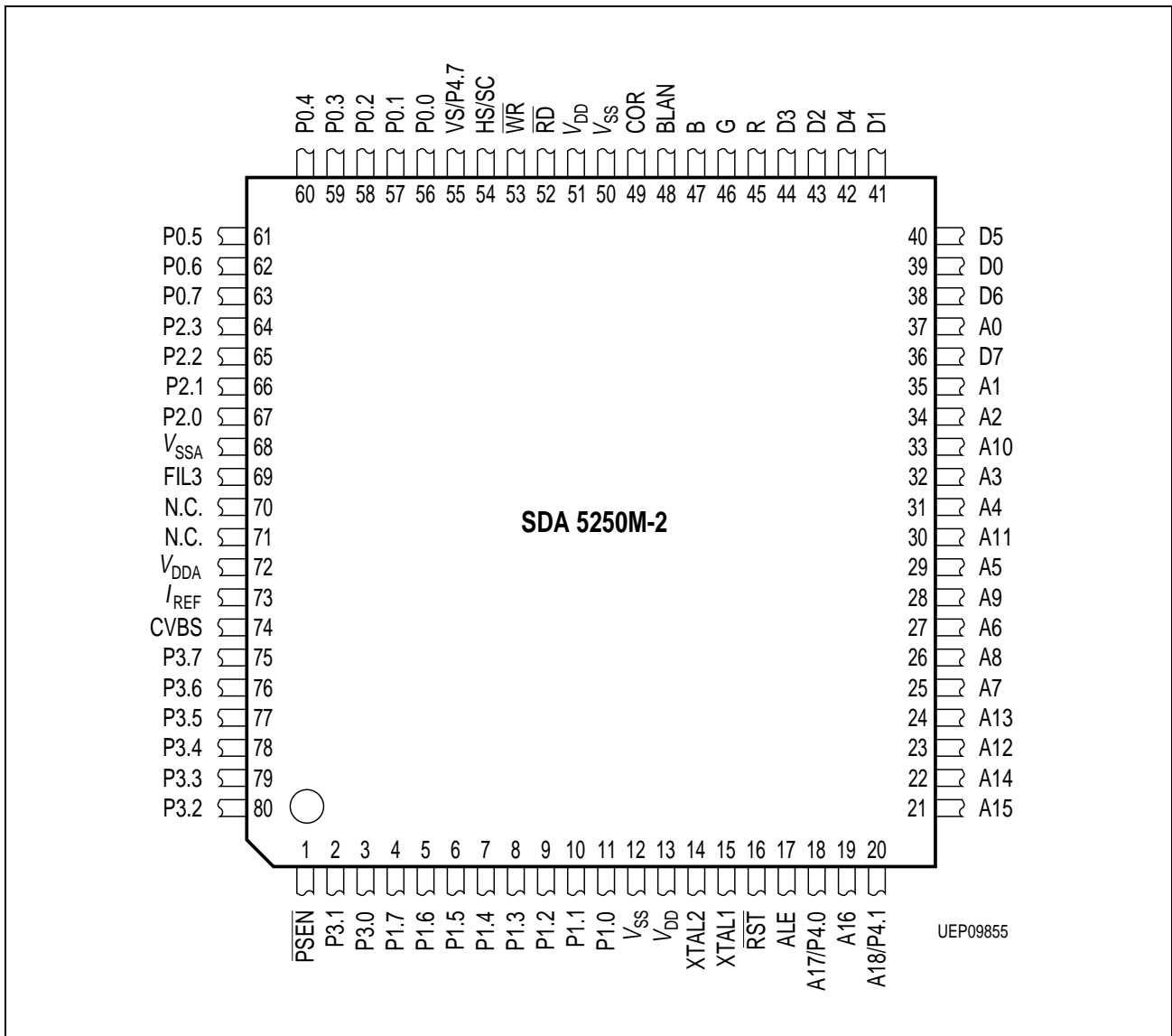

Figure 2

Differences compared to SDA 525x according to preliminary specification 06/96:

1. RGB-outputs deliver a current instead of a voltage (Pins 45, 46, 47).
2. Instead of FIL1SLC/FIL2SLC/FIL3SLC only FIL3 is needed with changed external device dimensions (Pin 69). Former FIL1SLC and FIL2SLC remain "not connected" (Pins 70, 71).
3. LCIN and LCOOUT are not needed any more and are now used for RD and WR (see 4.)
4. P-MQFP-80-1 now has RD (Pin 52), WR (53) and PSEN (1) Pins to connect external RAM.

'n.c.' = 'not connected' means: Pins must be left open.

4.2 P-LCC-84-2, Emulator-Version (top view)

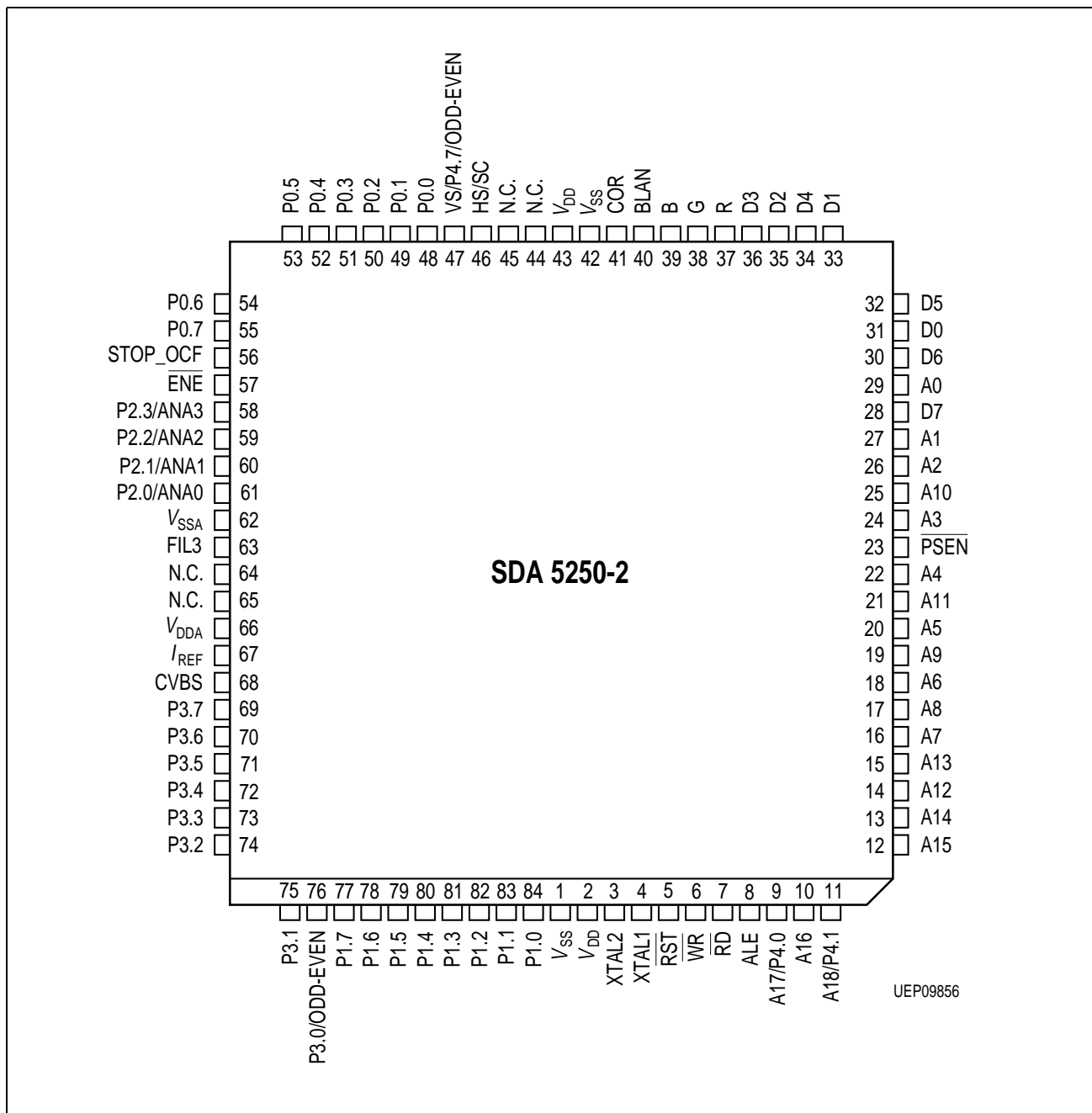

Figure 3

Differences compared to SDA 525x according to preliminary specification 06/96:

1. RGB-outputs deliver a current instead of a voltage (Pins 37, 38, 39).
 2. Instead of FIL1SLC/FIL2SLC/FIL3SLC only FIL3 is needed with changed external device dimensions (Pin 63). Former FIL1SLC and FIL2SLC remain "not connected" (Pins 64, 65).
 3. LCIN and LCOOUT are not needed any more and remain "not connected" (Pins 44, 45).
- 'n. c.' = 'not connected' means: Pins must be left open.

4.3 P-SDIP-52-1, ROM-Versions (top view)

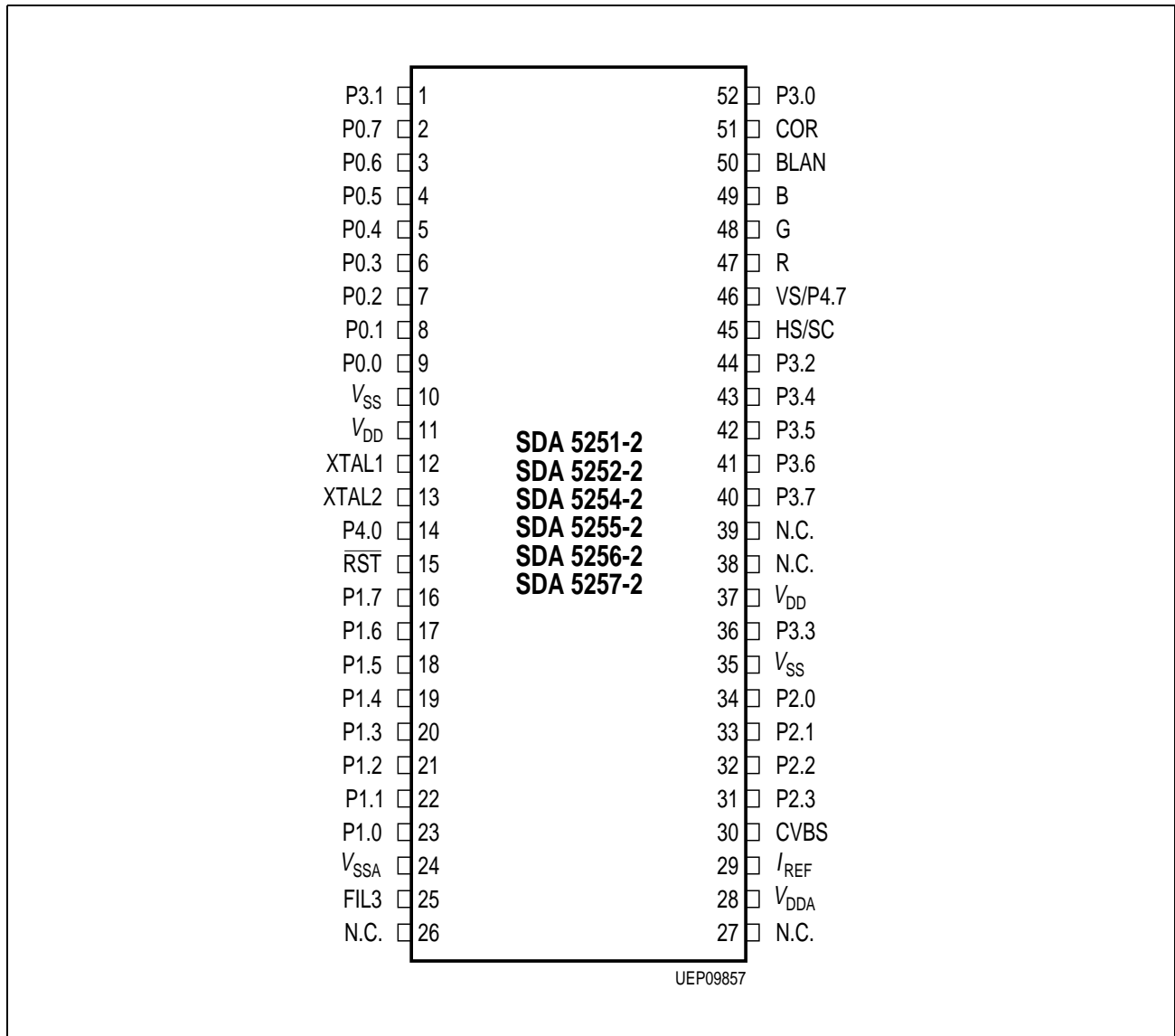

Figure 4

Differences compared to SDA 525x according to preliminary specification 06/96:

1. RGB-outputs deliver a current instead of a voltage (Pins 47, 48, 49).
 2. Instead of FIL1SLC/FIL2SLC/FIL3SLC only FIL3 is needed with changed external device dimensions (Pin 25). Former FIL1SLC and FIL2SLC remain "not connected" (Pins 26, 27).
 3. LCIN and LCOOUT are not needed any more and remain "not connected" (Pins 38, 39).
- 'n. c.' = 'not connected' means: Pins must be left open.

4.4 P-MQFP-64-1, ROM-Versions (top view)

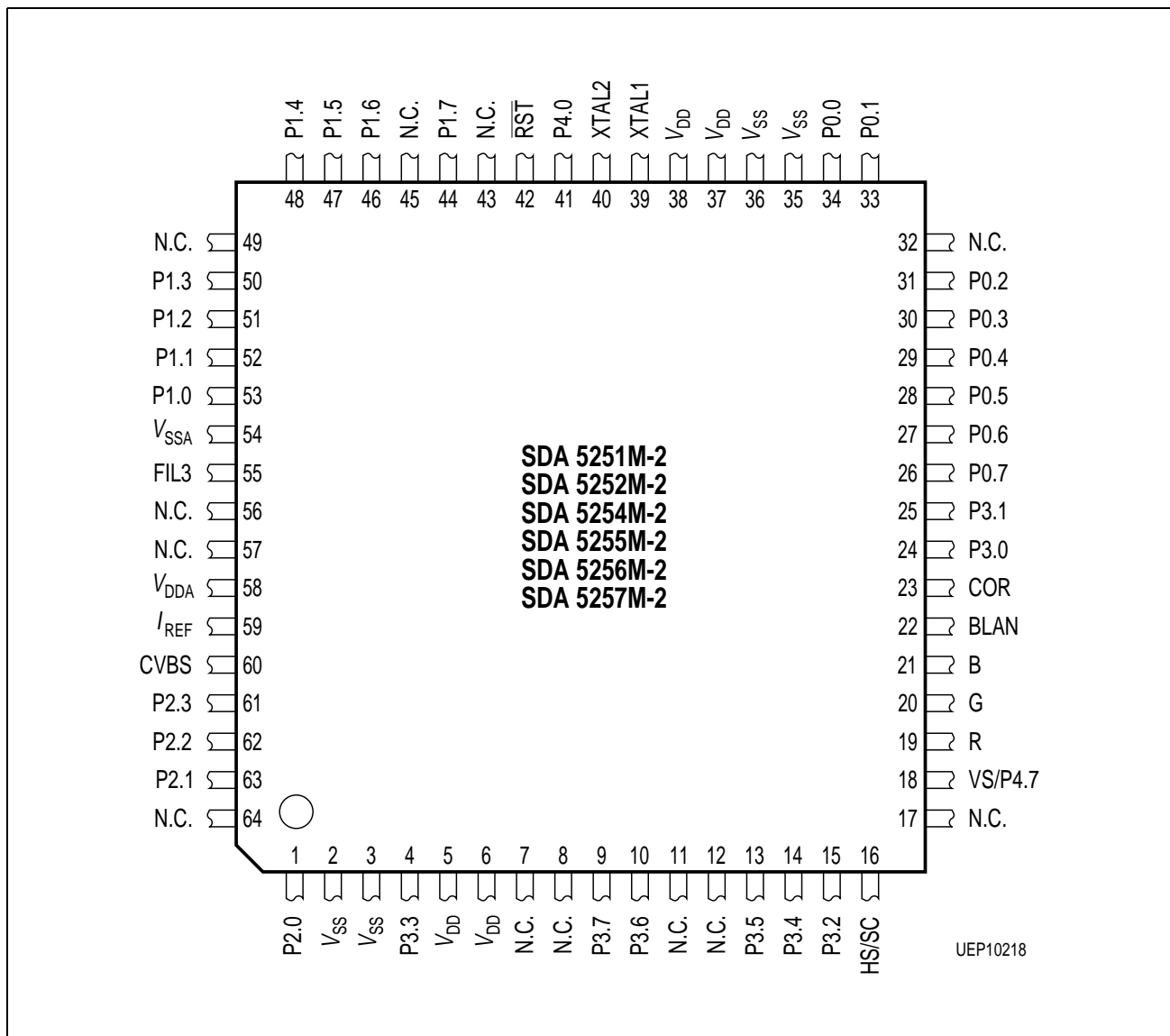

Figure 5

Differences compared to SDA 525x according to preliminary specification 06/96:

1. RGB-outputs deliver a current instead of a voltage (Pins 19, 20, 21).
 2. Instead of FIL1SLC/FIL2SLC/FIL3SLC only FIL3 is needed with changed external device dimensions (Pin 55). Former FIL1SLC and FIL2SLC remain "not connected" (Pins 56, 57).
 3. LCIN and LCOU are not needed any more and remain "not connected" (Pins 7, 8).
- 'n. c.' = 'not connected' means: Pins must be left open.

5 Pin Correspondence

Table 1
Pin Correspondence P-SDIP-52-1, P-MQFP-64-1, P-MQFP-80-1, P-MQFP-80-1, P-LCC-84-2

Symbol	Pin No. P-SDIP-52-1	Pin No. P-MQFP-64-1	Pin No. P-MQFP-80-1	Pin No. P-MQFP-80-1	Pin No. P-LCC-84-2	Changes compared to SDA 525x
P0.0	9	34	56	58	48	
P0.1	8	33	57	59	49	
P0.2	7	31	58	60	50	
P0.3	6	30	59	61	51	
P0.4	5	29	60	62	52	
P0.5	4	28	61	63	53	
P0.6	3	27	62	64	54	
P0.7	2	26	63	65	55	
P1.0	23	53	11	13	84	
P1.1	22	52	10	12	83	
P1.2	21	51	9	11	82	
P1.3	20	50	8	10	81	
P1.4	19	48	7	9	80	
P1.5	18	47	6	8	79	
P1.6	17	46	5	7	78	
P1.7	16	44	4	6	77	
P2.0	34	1	67	69	61	
P2.1	33	63	66	68	60	
P2.2	32	62	65	67	59	
P2.3	31	61	64	66	58	
XTAL2	13	40	14	16	3	6 MHz crystal
XTAL1	12	39	15	17	4	6 MHz crystal
RST	15	42	16	18	5	
V _{DD}	11, 37	5, 6, 37, 38	13, 51	15, 53	2, 43	
V _{SS}	10, 35	2, 3, 35, 36	12, 50	14, 52	1, 42	
R	47	19	45	47	37	current output
G	48	20	46	48	38	current output
B	49	21	47	49	39	current output
BLAN	50	22	48	50	40	
COR	51	23	49	51	41	
P3.0	52	24	3	5	76	
P3.1	1	25	2	4	75	
P3.2	44	15	80	2	74	
P3.3	36	4	79	1	73	
P3.4	43	14	78	80	72	
P3.5	42	13	77	79	71	
P3.6	41	10	76	78	70	
P3.7	40	9	75	77	69	

Table 1

Pin Correspondence P-SDIP-52-1, P-MQFP-64-1, P-MQFP-80-1, P-MQFP-80-1,
P-LCC-84-2 (cont'd)

Symbol	Pin No. P-SDIP-52-1	Pin No. P-MQFP-64-1	Pin No. P-MQFP-80-1	Pin No. P-MQFP-80-1	Pin No. P-LCC-84-2	Changes compared to SDA 525x
HS/SC	45	16	54	56	46	
VS/P4.7/ ODD-EVEN	46	18	55	57	47	
CVBS	30	60	74	76	68	New ext. comp. values
I_{REF}	29	59	73	75	67	New ext. comp. values
V_{DDA} V_{SSA}	28 24	58 24	72 68	74 70	66 62	
FIL3	25	55	69	71	63	New ext. comp. values, FIL1/2 not needed
P4.0	14	41	18	20	9	

LCIN and LCOU are not needed any longer.

Additional Pin Correspondence P-MQFP-80-1 and P-LCC-84-2

Table 2
Pin Correspondence P-MQFP-80-1, P-MQFP-80-1, P-LCC-84-2

Symbol	Pin No. P-MQFP-80-1	Pin No. P-MQFP-80-1	Pin No. P-LCC-84-2	Changes vs. SDA 525x
A0	37	39	29	
A1	35	37	27	
A2	34	36	26	
A3	32	34	24	
A4	31	33	22	
A5	29	31	20	
A6	27	29	18	
A7	25	27	16	
A8	26	28	17	
A9	28	30	19	
A10	33	35	25	
A11	30	32	21	
A12	23	25	14	
A13	24	26	15	
A14	22	24	13	
A15	21	23	12	
A16	19	21	10	
D0	39	41	31	
D1	41	43	33	
D2	43	45	35	
D3	44	46	36	
D4	42	44	34	
D5	40	42	32	
D6	38	40	30	
D7	36	38	28	
STOP_OCF	–	–	56	
ENE	–	–	57	
<u>RD</u>	52	54	7	<i>new for MQFP</i>
<u>WR</u>	53	55	6	<i>new for MQFP</i>
<u>ALE</u>	17	19	8	
<u>PSEN</u>	1	3	23	<i>new for MQFP</i>
P4.1	20	22	11	

6 Differences of SDA 525x-2 Compared to SDA 525x

This delta specification describes the differences of the SDA 525x-2 compared to the SDA 525x as described in the preliminary data sheet 1997-09-01.

6.1 Hardware-Compatibility

TVT-2 is pin-compatible to previous versions of TVT. However, some variations in external components become necessary (see Application Circuit in Chapter 10):

1. *The LC-oscillator is not necessary any longer.*
2. *The filters 1 and 2 are not needed any longer. Only filter 3 is needed but with different external device dimensions.*
3. *Since the RBG outputs deliver a current, a voltage divider can be replaced by a single resistor (see TVText Design Guide).*
4. *The external crystal is now 6 MHz instead of 18 MHz.*
5. *The CVBS-pin needs different dimensioning of the external components due to changes in the internal clamping circuit.*
6. *The Iref-pin needs different dimensioning of the external components and an additional blocking capacitor.*
7. *To avoid clock cross-talk and to improve the slicer performance use filter circuits at the power supply pins to decouple digital and analog supplies.*
8. *Due to a reworked analog concept with the advantage of a more stable circuits and better performance the power consumption has increased. For the Romless version a maximum overall IDD-current of 95mA can be reached, for ROM versions up to 100mA.*

Furthermore, the MQFP-80-packages now have \overline{RD} , \overline{WR} , and \overline{PSEN} pins to connect to external RAM.

6.2 Software-Compatibility

Only slight software changes may be necessary due to some register changes (see chapter 7).

6.3 Improved Performance Sync- and Data-Slicer

Due to crystal locked PLLs the robustness of the sync- and data-slicer is improved.

6.4 Crystal-locked Display-PLL

The display clock will be locked to the internal PLL locked to the single external 6-MHz-crystal and, by this, will have very low jitter. Furthermore, the display width will not vary. Procedures to adjust the display clock have to be disabled.

6.5 Improved Interface to External RAM

The SDA 5250M-2 (ROMless version P-MQFP-80-1) can also be used with external RAM, because the pins \overline{RD} , \overline{WR} and \overline{PSEN} are available. Furthermore, optional banking

of external XDATA-memory will be possible, controlled by A16, A17, A18. This offers a maximum of flexibility for 128-page-acquisition (see separate application note).

6.6 No UART

As described already in the errata sheet 03/97, release 1.0, the newer versions of the SDA 525x and the SDA 525x-2 will not support a serial port (UART) any more.

6.7 VS Sampling

The internal sampling time of the vertical sync pulse coming from either the VS pin or from the sandcastle signal applied at the pin HS/SC is most important for a stable display. Because the VSYNC inside a TV set is often delayed by external components, the real relation-ship of the VS-phase and the appropriate picture frame may get lost. The sampling time of the SDA 525x is derived from an internal display signal which can only be modified by programming different horizontal offset values (DHD-Register). This has the side-effect that depending on the desired horizontal offset the sampling point is also varied and may show an unstable display. To avoid this dependency, the SDA 525x-2 has a separate register to determine the VS sampling point with respect to the HS pulse, which may be varied over a whole line in steps of 8 μ s. External components for VS delaying are no more necessary and can be removed if the programmed VS sampling points fits to the external timing between HS, VS and the actual frame (even/odd). To get a better timing resolution in 100 Hz-applications a special bit has been implemented to reduce the intervals between the possible sampling points from 8 to 4 μ s. The register bits are described below. The following diagram shows the internal VS processing in principle.

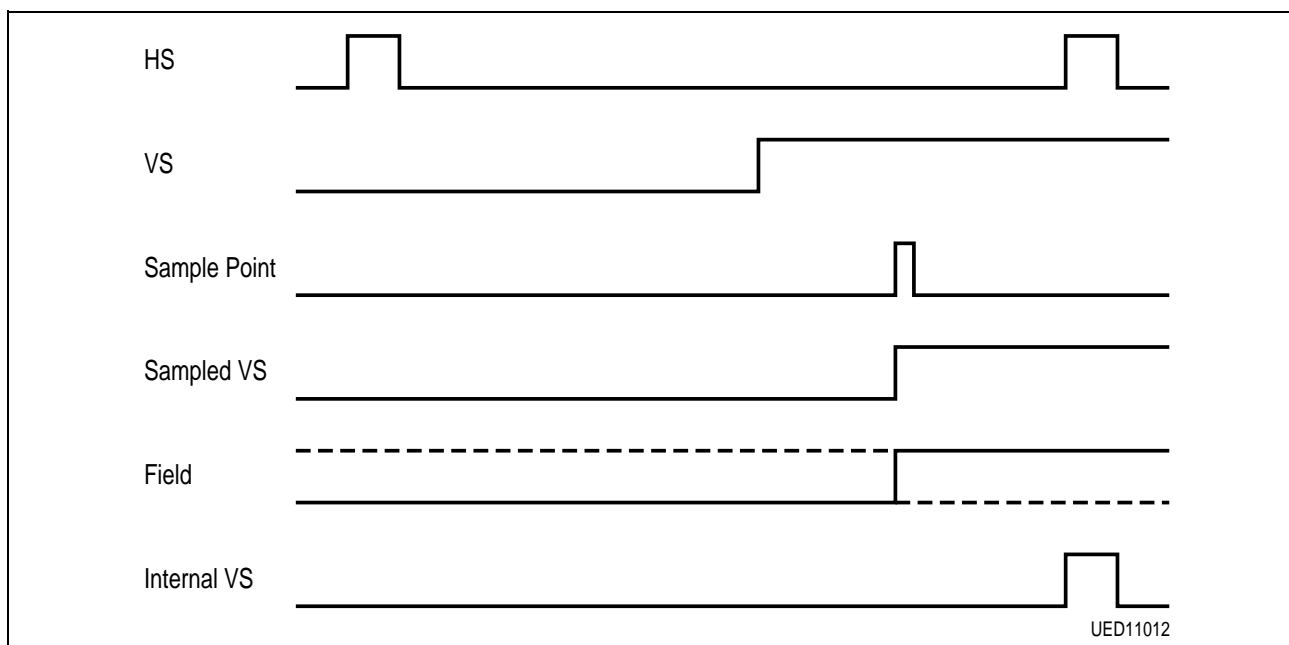

Figure 6
Internal VS Processing

Default after reset: 02_H

DAFR1

SFR Address B1_H

(MSB)

(LSB)

-	-	-	-	VS100	VD.2	VD.1	VD.0
---	---	---	---	-------	------	------	------

Bit 7 ... 4 Must be set to 0

VD Vertical Delay: Reset value 0010, corresponds to 20 microsecond delay.
 If VS100 = 0, delay can be set to 4, 12, 20, 28, 36, 44, 52, 60 μs
 If VS100 = 1, delay can be set to 2, 6, 10, 14, 18, 22, 26, 30 μs

VS100 For VD bits selects the sampling mode
 0 = 50 Hz
 1 = 100 Hz

Following table gives an overview of the sampling point equivalents of the SDA 525x and the SDA 525x-2 at a selected pixel frequency of 12 MHz.

Sample Point in μs	Equivalent DHD-Setup for SDA 525x (decimal)	Equivalent Register Setup for SDA 525x-2 (binary)
4	not possible	000
12	207	001
20	111	010
28	15	011
36	not possible	100
44	not possible	101
52	not possible	110
60	not possible	111

6.8 RGB and Blanking Skew

In some applications the BLANK line is delayed by external components and/or special video ICs and thus gets a delay with respect to the RGB- and COR lines which corrupts the display by means of white and black vertical stripes at the beginning and at the end of an OSD menu. To reduce this skew to an acceptable value, the RGB- and COR-lines can be delayed by multiple of a pixel duration.

Default after reset: 00_H

DAFR2

SFR Address B2_H

(MSB)

(LSB)

-	-	-	-	-	-	RGBD.1	RGBD.0
---	---	---	---	---	---	--------	--------

Bit 7 ... 2 Must be set to 0

RGBD1 ... 0 RGB Delay in pixels counts

- = 00 No delay
- = 01 one pixel delay
- = 10 two pixels delay
- = 11 three pixel delay

7 Registers of SDA 525x-2

It is very important, that registers not named or marked by “xxxx” here may in no case be used in any way!

Register SDA 525x-2									
Name	Address	Bit7	Bit6	Bit5	Bit4	Bit3	Bit2	Bit1	Bit0
Common Functions									
AFR	A6	CDC	WDT	0	0	0	0	0	0
ACC	E0	ACC.7	ACC.6	ACC.5	ACC.4	ACC.3	ACC.2	ACC.1	ACC.0
B	F0	B.7	B.6	B.5	B.4	B.3	B.2	B.1	B.0
PSW	D0	CY	AC	F0	RS1	RS0	OV	F1	P
SP	81	SP.7	SP.6	SP.5	SP.4	SP.3	SP.2	SP.1	SP.0
DPH	83	DPH.7	DPH.6	DPH.5	DPH.4	DPH.3	DPH.2	DPH.1	DPH.0
DPL	82	DPL.7	DPL.6	DPL.5	DPL.4	DPL.3	DPL.2	DPL.1	DPL.0
DPSEL	A2						DPSEL.2	DPSEL.1	DPSEL.0
PCON	87	SMOD	PDS	IDLS				PDE	IDLE
Emulation Functions (Emulation Version only)									
EMREG	FE	EM.7	EM.6	EM.5	EM.4	EM.3	EM.2	EM.1	EM.0
Acquisition									
ACQSIR	C0	EVENEN	EVENST	LIN24EN	LIN24ST	AVIREN	AVIRST	AHIREN	AHIRST
ACQMS1	C1	OSDACQ	WSSE	VPSE	NTSC	CRIC.1	CRIC.0	ENERT	TTXE
ACQMS2	C2				TEST.4	TEST.3	TEST.2	TEST.1	TEST.0
Display Generator									
DHD	C3	HD.7	HD.6	HD.5	HD.4	HD.3	HD.2	HD.1	HD.0
DVD	C4			VD.5	VD.4	VD.3	VD.2	VD.1	VD.0
DTCR	C5	CORI	CORO	ICRP	IBP	TRFI	TRFO	TRBI	TRBO
DMODE1	C6	ST_TOP	ST_DIS	CON	DH.1	DH.0	BD_24	BD_1_23	BD_0
DMODE2	C7				DCHAP.2	DCHAP.1	DCHAP.0	C10	C7
TTXSIR	C8		VSY	HSY	PCLK	DVIREN	DVIRST	DHIREN	DHIRST
LANGC	C9	OSD_64	LANGC.6	LANGC.5	LANGC.4	LANGC.3	LANGC.2	LANGC.1	LANGC.0
DCCP	CA		DC_EN	DCCP.5	DCCP.4	DCCP.6	DCCP.5	DCCP.7	DCCP.6
DCRP	CB	TRBOS	COROS		DCRP.4	DCRP.3	DCRP.2	DCRP.1	DCRP.0
DTIM	CC	BG_R	BG_G	BG_B	EO_P30	EO_VS	SANDC	LIN9	LIN8
SCCON	CE	CORTM	SCCH.2	SCCH.1		FL5MX	SCCL.2	SCCL.1	SCCL.0
DMOD	D6				BG_MODE	VPS_TM	HG_MOD	DH_MODE	DSDW
Analog to Digital Converter									
ADCON	D8	xxxx	xxxx	IADC	BSY	ADM	0	MX1	MX0
ADDAT	D9	AD7	AD6	AD5	AD4	AD3	AD2	AD1	AD0
DAPR	DA								
Pulse Width Modulator									
PWME	F8	E7	E6	E5	E4	E3	E2	E1	E0
PWCL	F7	PWCL.7	PWCL.6	PWCL.5	PWCL.4	PWCL.3	PWCL.2	PWCL.1	PWCL.0
PWCH	F9	PWCH.7	PWCH.6	PWCH.5	PWCH.4	PWCH.3	PWCH.2	PWCH.1	PWCH.0
PWCOMP0	F1	COMP0.7	COMP0.6	COMP0.5	COMP0.4	COMP0.3	COMP0.2	COMP0.1	COMP0.0
PWCOMP1	F2	COMP1.7	COMP1.6	COMP1.5	COMP1.4	COMP1.3	COMP1.2	COMP1.1	COMP1.0
PWCOMP2	F3	COMP2.7	COMP2.6	COMP2.5	COMP2.4	COMP2.3	COMP2.2	COMP2.1	COMP2.0
PWCOMP3	F4	COMP3.7	COMP3.6	COMP3.5	COMP3.4	COMP3.3	COMP3.2	COMP3.1	COMP3.0
PWCOMP4	F5	COMP4.7	COMP4.6	COMP4.5	COMP4.4	COMP4.3	COMP4.2	COMP4.1	COMP4.0
PWCOMP5	F6	COMP5.7	COMP5.6	COMP5.5	COMP5.4	COMP5.3	COMP5.2	COMP5.1	COMP5.0
PWCOMP6	FB	COMP6.7	COMP6.6	COMP6.5	COMP6.4	COMP6.3	COMP6.2	COMP6.1	COMP6.0
PWEXT6	FA	EXT6.7	EXT6.6	EXT6.5	EXT6.4	EXT6.3	EXT6.2	EXT6.1	EXT6.0
PWCOMP7	FD	COMP7.7	COMP7.6	COMP7.5	COMP7.4	COMP7.3	COMP7.2	COMP7.1	COMP7.0
PWEXT7	FC	EXT7.7	EXT7.6	EXT7.5	EXT7.4	EXT7.3	EXT7.2	EXT7.1	EXT7.0
Port Functions									
P0	80	P0.7	P0.6	P0.5	P0.4	P0.3	P0.2	P0.1	P0.0
P1	90	P1.7	P1.6	P1.5	P1.4	P1.3	P1.2	P1.1	P1.0
P2	A0					P2.3	P2.2	P2.1	P2.0
P3	B0	P3.7	P3.6	P3.5	P3.4	P3.3	P3.2	P3.1	P3.0
P4	E8							P4.1	P4.0
Serial Interface									
SCON	98	xxxx	xxxx	xxxx	xxxx	xxxx	xxxx	xxxx	xxxx
SBUF	99	xxxx	xxxx	xxxx	xxxx	xxxx	xxxx	xxxx	xxxx
Interrupt Controller									
IE	A8	EA	EADC	ETSI	xxxx	ETI	EX1	ET0	EX0
IP0	A9		IP0.6	IP0.5	IP0.4	IP0.3	IP0.2	IP0.1	IP0.0
IP1	AA		IP1.6	IP1.5	IP1.4	IP1.3	IP1.2	IP1.1	IP1.0
IRCON	AB					EX1R	EX1F	EX0R	EX0F
Timer 0/1									
TMOD	89	GATE	C/T	M1	M0	GATE	C/T	M1	M0
TCON	88	TF1	TR1	TF0	TR0	IE1	IT1	IE0	IT0
TH1	8D	TH1.7	TH1.6	TH1.5	TH1.4	TH1.3	TH1.2	TH1.1	TH1.0
TH0	8C	TH0.7	TH0.6	TH0.5	TH0.4	TH0.3	TH0.2	TH0.1	TH0.0
TL1	8B	TL1.7	TL1.6	TL1.5	TL1.4	TL1.3	TL1.2	TL1.1	TL1.0
TL0	8A	TL0.7	TL0.6	TL0.5	TL0.4	TL0.3	TL0.2	TL0.1	TL0.0

continued on next page ...

Register SDA 525x-2									
Name	Address	Bit7	Bit6	Bit5	Bit4	Bit3	Bit2	Bit1	Bit0
Watchdog Timer									
WDCON	A7	WDTS	SWDT						
WDTREL	86	WDTREL.7	WDTREL.6	WDTREL.5	WDTREL.4	WDTREL.3	WDTREL.2	WDTREL.1	WDTREL.0
WDTL	84	WDTL.7	WDTL.6	WDTL.5	WDTL.4	WDTL.3	WDTL.2	WDTL.1	WDTL.0
WDTH	85	WDTH.7	WDTH.6	WDTH.5	WDTH.4	WDTH.3	WDTH.2	WDTH.1	WDTH.0
Infrared Capture-/Compare Timer									
RELL	E1	RELL.7	RELL.6	RELL.5	RELL.4	RELL.3	RELL.2	RELL.1	RELL.0
RELH	E2	RELH.7	RELH.6	RELH.5	RELH.4	RELH.3	RELH.2	RELH.1	RELH.0
CAPL	E3	CAPL.7	CAPL.6	CAPL.5	CAPL.4	CAPL.3	CAPL.2	CAPL.1	CAPL.0
CAPH	E4	CAPH.7	CAPH.6	CAPH.5	CAPH.4	CAPH.3	CAPH.2	CAPH.1	CAPH.0
IRTCON	E5	OV	PR	PLG	REL	RUN	RISE	FALL	SEL
Memory Management Unit (ROM-less versions only)									
MEX1	94		CB18	CB17	CB16		NB18	NB17	NB16
MEX2	95	MM	MB18	MB17	MB16	SF	IB18	IB17	IB16

= Register Bit read-only xxxx = Register Bit not available and not needed any longer
 = Register Bit write-only

Differences compared to SDA 525x according to preliminary specification 06/96:

1. The serial interface is not supported any longer. By this, registers *SCON* and *SBUF* are no longer available. The “Serial Interrupt Enable Flag” *ES* of the Interrupt Enable register (Bit 4 of *A8*) must not be written (default after reset = 0).
2. The functions and bits *Prescaler Control (PSC)* and *ADC sample time (STADC)* of the Special Function Register *ADCON* are not available any more. Bits 7 and 6 of *D8* must be 0.
3. The registers following must not be written. The software needs to be checked accordingly.
SBUF (99): *Bits 0 to 7*
SCON (98): *Bits 0 to 7*
ACQMS2 (C2): *Bits 0 to 7*
DMODE2 (C7): *Bits 5 to 7*
ADCON (D8): *Bits 6 and 7*
IE (A8): *Bit 4*
 The allowed bits of *DMODE2*, *ADCON* and *IE* have to be changed with the commands *ANL* or *ORL*.

7.1 Address Space of SDA 525x-2

The registers of the SDA 525x-2 sorted by address are listed in the table following:

Register SDA 525x-2 sorted by address

Address decimal	Name	Address hex	Bit7	Bit6	Bit5	Bit4	Bit3	Bit2	Bit1	Bit0
128	P0	80	P0.7	P0.6	P0.5	P0.4	P0.3	P0.2	P0.1	P0.0
129	SP	81	SP.7	SP.6	SP.5	SP.4	SP.3	SP.2	SP.1	SP.0
130	DPL	82	DPL.7	DPL.6	DPL.5	DPL.4	DPL.3	DPL.2	DPL.1	DPL.0
131	DPH	83	DPH.7	DPH.6	DPH.5	DPH.4	DPH.3	DPH.2	DPH.1	DPH.0
132	WDTL	84	WDTL.7	WDTL.6	WDTL.5	WDTL.4	WDTL.3	WDTL.2	WDTL.1	WDTL.0
133	WDTH	85	WDTH.7	WDTH.6	WDTH.5	WDTH.4	WDTH.3	WDTH.2	WDTH.1	WDTH.0
134	WDTREL	86	WDTREL.7	WDTREL.6	WDTREL.5	WDTREL.4	WDTREL.3	WDTREL.2	WDTREL.1	WDTREL.0
135	PCON	87	SMOD	PDS	IDL5				PDE	IDLE
136	TCON	88	TF1	TR1	TF0	TR0	IE1	IT1	IE0	IT0
137	TMOD	89	GATE	C/T	M1	M0	GATE	C/T	M1	M0
138	TL0	8A	TL0.7	TL0.6	TL0.5	TL0.4	TL0.3	TL0.2	TL0.1	TL0.0
139	TL1	8B	TL1.7	TL1.6	TL1.5	TL1.4	TL1.3	TL1.2	TL1.1	TL1.0
140	TH0	8C	TH0.7	TH0.6	TH0.5	TH0.4	TH0.3	TH0.2	TH0.1	TH0.0
141	TH1	8D	TH1.7	TH1.6	TH1.5	TH1.4	TH1.3	TH1.2	TH1.1	TH1.0
144	P1	90	P1.7	P1.6	P1.5	P1.4	P1.3	P1.2	P1.1	P1.0
148	MEX1	94		CB18	CB17	CB16		NB18	NB17	NB16
149	MEX2	95	MM	MB18	MB17	MB16	SF	IB18	IB17	IB16
160	P2	A0					P2.3	P2.2	P2.1	P2.0
162	DPSEL	A2						DPSEL.2	DPSEL.1	DPSEL.0
166	AFR	A6	CDC	WDT	0	0	0	0	0	0
167	WDCON	A7	WDT5	SWDT						
168	IE	A8	EA	EADC	ETSI	xxxx	ETI	EX1	ET0	EX0
169	IP0	A9		IP0.6	IP0.5	IP0.4	IP0.3	IP0.2	IP0.1	IP0.0
170	IP1	AA		IP1.6	IP1.5	IP1.4	IP1.3	IP1.2	IP1.1	IP1.0
171	IRCON	AB					EX1R	EX1F	EX0R	EX0F
176	P3	B0	P3.7	P3.6	P3.5	P3.4	P3.3	P3.2	P3.1	P3.0
192	ACQSIR	C0	EVENEN	EVENST	LIN24EN	LIN24ST	AVIREN	AVIRST	AHIREN	AHIRST
193	ACQMS1	C1	OSDACQ	WSSE	VPSE	NTSC	CRIC.1	CRIC.0	ENERT	TTXE
194	ACQMS2	C2	LIN5EN	LIN5ST		TEST.4	TEST.3	TEST.2	TEST.1	TEST.0
195	DHD	C3	HD.7	HD.6	HD.5	HD.4	HD.3	HD.2	HD.1	HD.0
196	DVD	C4			VD.5	VD.4	VD.3	VD.2	VD.1	VD.0
197	DTCR	C5	CORI	CORO	ICRP	IBP	TRFI	TRFO	TRBI	TRBO
198	DMODE1	C6	ST_TOP	ST_DIS	CON	DH.1	DH.0	BD_24	BD_1_23	BD_0
199	DMODE2	C7				DCHAP.2	DCHAP.1	DCHAP.0	C10	C7
200	TTXSIR	C8		VSY	HSY	PCLK	DVIREN	DVIRST	DHIREN	DHIRST
201	LANGC	C9	OSD_64	LANGC.6	LANGC.5	LANGC.4	LANGC.3	LANGC.2	LANGC.1	LANGC.0
202	DCCP	CA		DC_EN	DCCP.5	DCCP.4	DCCP.3	DCCP.2	DCCP.1	DCCP.0
203	DCRP	CB	TRBOS	COROS		DCRP.4	DCRP.3	DCRP.2	DCRP.1	DCRP.0
204	DTIM	CC	BG_R	BG_G	BG_B	EO_P30	EO_VS	SANDC	LIN9	LIN8
206	SCCON	CE	CORTM	SCCH.2	SCCH.1	SCCH.0	FL5MX	SCCL.2	SCCL.1	SCCL.0
208	PSW	D0	CY	AC	F0	RS1	RS0	OV	F1	P
214	DMOD	D6				BG_MODE	VPS_TM	HG_MOD	DH_MODE	DSDW
216	ADCON	D8	xxxx	xxxx	IADC	BSY	ADM	0	MX1	MX0
217	ADDAT	D9	AD7	AD6	AD5	AD4	AD3	AD2	AD1	AD0
218	DAPR	DA								
224	ACC	E0	ACC.7	ACC.6	ACC.5	ACC.4	ACC.3	ACC.2	ACC.1	ACC.0
225	RELL	E1	RELL.7	RELL.6	RELL.5	RELL.4	RELL.3	RELL.2	RELL.1	RELL.0
226	RELH	E2	RELH.7	RELH.6	RELH.5	RELH.4	RELH.3	RELH.2	RELH.1	RELH.0
227	CAPL	E3	CAPL.7	CAPL.6	CAPL.5	CAPL.4	CAPL.3	CAPL.2	CAPL.1	CAPL.0
228	CAPH	E4	CAPH.7	CAPH.6	CAPH.5	CAPH.4	CAPH.3	CAPH.2	CAPH.1	CAPH.0
229	IRTCON	E5	OV	PR	PLG	REL	RUN	RISE	FALL	SEL
232	P4	E8							P4.1	P4.0
240	B	F0	B.7	B.6	B.5	B.4	B.3	B.2	B.1	B.0
241	PWCOMP0	F1	COMP0.7	COMP0.6	COMP0.5	COMP0.4	COMP0.3	COMP0.2	COMP0.1	COMP0.0
242	PWCOMP1	F2	COMP1.7	COMP1.6	COMP1.5	COMP1.4	COMP1.3	COMP1.2	COMP1.1	COMP1.0
243	PWCOMP2	F3	COMP2.7	COMP2.6	COMP2.5	COMP2.4	COMP2.3	COMP2.2	COMP2.1	COMP2.0
244	PWCOMP3	F4	COMP3.7	COMP3.6	COMP3.5	COMP3.4	COMP3.3	COMP3.2	COMP3.1	COMP3.0
245	PWCOMP4	F5	COMP4.7	COMP4.6	COMP4.5	COMP4.4	COMP4.3	COMP4.2	COMP4.1	COMP4.0
246	PWCOMP5	F6	COMP5.7	COMP5.6	COMP5.5	COMP5.4	COMP5.3	COMP5.2	COMP5.1	COMP5.0
247	PWCL	F7	PWCL.7	PWCL.6	PWCL.5	PWCL.4	PWCL.3	PWCL.2	PWCL.1	PWCL.0
248	PWME	F8	E7	E6	E5	E4	E3	E2	E1	E0
249	PWCH	F9	PWCH.7	PWCH.6	PWCH.5	PWCH.4	PWCH.3	PWCH.2	PWCH.1	PWCH.0
250	PWEXT6	FA	EXT6.7	EXT6.6	EXT6.5	EXT6.4	EXT6.3	EXT6.2	EXT6.1	EXT6.0
251	PWCOMP6	FB	COMP6.7	COMP6.6	COMP6.5	COMP6.4	COMP6.3	COMP6.2	COMP6.1	COMP6.0
252	PWEXT7	FC	EXT7.7	EXT7.6	EXT7.5	EXT7.4	EXT7.3	EXT7.2	EXT7.1	EXT7.0
253	PWCOMP7	FD	COMP7.7	COMP7.6	COMP7.5	COMP7.4	COMP7.3	COMP7.2	COMP7.1	COMP7.0
254	EMREG	FE	EM.7	EM.6	EM.5	EM.4	EM.3	EM.2	EM.1	EM.0

The address space for MOVX is distributed as follows:

- 0000 - 7FFF: reserved for external SRAM (32k)
- 8000 - 9FFF: reserved for future extensions (8k)
- A000 - BFFF: read access to Pixel-ROM via MOVX-command (8k)
- C000 - DFFF: display-chapters 1 to 8 (8k)
- E000 - E7FF: display-chapters 9 and 10 (2k) (optional)

E800 - F3FF: reserved for future extensions (3k)
 F400 - F7FF: VBI buffer (1k)
 F800 - FBFF: CPU RAM (1k)
 FC00- FFFF: reserved for future extensions (1k)

8 Software Changes

All calls of the subroutine "adjust_horizontal" (inside the module IFRDEMO.C51 on the Firmware Demo Disk) must be removed from the external controller software. This routine was developed to adjust the display to the middle of the screen according to tolerances of the LC-oscillator. This oscillator is not used any more. The pixel clock is derived from the single external crystal. However, customers who are using SDA 525x-2 without emulating with SDA 5250-2 or 5250M-2 need to use some adjustment routine for their first circuits. As soon as the correct adjustment is known, it can be used as a fixed value for initialization or for future software.

Furthermore, due to some changes in the special function registers, the software needs to be checked. The changes are in detail:

1. *The serial interface is not supported any longer. By this, registers SCON and SBUF are no longer available. The "Serial Interrupt Enable Flag" ES of the Interrupt Enable register (Bit 4 of A8) must not be written (default after reset = 0).*
2. *The functions and bits Prescaler Control (PSC) and ADC sample time (STADC) of the Special Function Register ADCON are not available any more. Bits 7 and 6 of D8 must be 0.*
3. *The registers following must not be written. The software needs to be checked accordingly.*

<i>SBUF (99):</i>	<i>Bits 0 to 7</i>
<i>SCON (98):</i>	<i>Bits 0 to 7</i>
<i>ACQMS2 (C2):</i>	<i>Bits 0 to 7</i>
<i>DMODE2 (C7):</i>	<i>Bits 5 to 7</i>
<i>ADCON (D8):</i>	<i>Bits 6 and 7</i>
<i>IE (A8):</i>	<i>Bit 4</i>

The allowed bits of DMODE2, ADCON and IE have to be changed with the commands ANL or ORL.

9 Timing

Although the frequency of the external quartz is now 6 MHz, all the internal timings correspond to that of the SDA525x with an 18 MHz quartz. This is achieved by an internal PLL.

10 Application Circuit

Use of SDA 525x-2 (Design Step B) as replacement for SDA 525x:

(For more detailed application hints refer to 'TVText Design Guide V1.5')

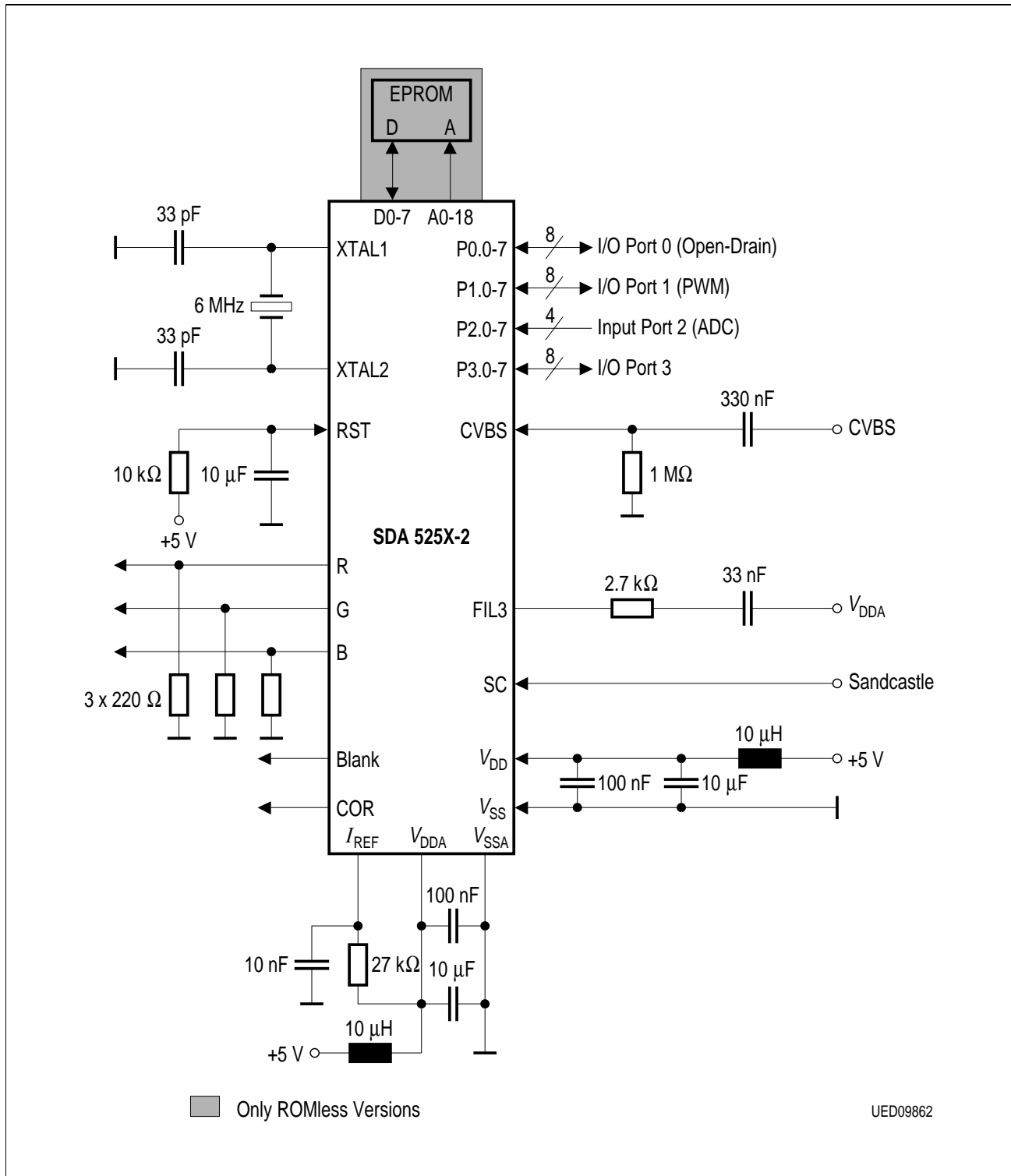

Figure 7

Necessary changes compared to SDA 525x according to preliminary data sheet 1998-02-18 are:

1. *RGB-outputs deliver a current instead of a voltage. Any voltage divider can be replaced by a single resistor. This resistor will have a different dimension. The nominal output current is 5.2 mA with a resistor of 27 k Ω at the I_{REF} -pin.*
 2. *Instead of FIL1SLC/FIL2SLC/FIL3SLC only FIL3 is needed with changed external device dimensions. Former FIL1SLC and FIL2SLC remain "not connected". For best slicer performance FIL3 is tied to V_{DDA} . FIL3 may be tied to V_{SSA} , if a ripple free V_{DDA} is available.*
 3. *LCIN and LCOOUT are not needed any more and are not connected or used for RD and WR in the P-MQFP-80-1-package, respectively.*
 4. *P-MQFP-80-1 now has \overline{RD} (Pin 52), \overline{WR} (53) and \overline{PSEN} (1) Pins to connect external RAM.*
 5. *The 18-MHz-crystal is replaced by a 6-MHz type.*
- 'n. c.' = 'not connected' means: Pins must be left open.