



PRELIMINARY

## 80C186EB/80C188EB AND 80L186EB/80L188EB 16-BIT HIGH-INTEGRATION EMBEDDED PROCESSORS

### ■ Full Static Operation

### ■ True CMOS Inputs and Outputs

- **Integrated Feature Set**
  - Low-Power Static CPU Core
  - Two Independent UARTs each with an Integral Baud Rate Generator
  - Two 8-Bit Multiplexed I/O Ports
  - Programmable Interrupt Controller
  - Three Programmable 16-Bit Timer/Counters
  - Clock Generator
  - Ten Programmable Chip Selects with Integral Wait-State Generator
  - Memory Refresh Control Unit
  - System Level Testing Support (ONCE Mode)
- **Direct Addressing Capability to 1 Mbyte Memory and 64 Kbyte I/O**
- **Speed Versions Available (5V):**
  - 25 MHz (80C186EB25/80C188EB25)
  - 20 MHz (80C186EB20/80C188EB20)
  - 13 MHz (80C186EB13/80C188EB13)
- **Available in Extended Temperature Range (–40°C to +85°C)**
- **Speed Versions Available (3V):**
  - 16 MHz (80L186EB16/80L188EB16)
  - 13 MHz (80L186EB13/80L188EB13)
  - 8 MHz (80L186EB8/80L188EB8)
- **Low-Power Operating Modes:**
  - Idle Mode Freezes CPU Clocks but keeps Peripherals Active
  - Powerdown Mode Freezes All Internal Clocks
- **Supports 80C187 Numeric Coprocessor Interface (80C186EB PLCC Only)**
- **Available In:**
  - 80-Pin Quad Flat Pack (QFP)
  - 84-Pin Plastic Leaded Chip Carrier (PLCC)
  - 80-Pin Shrink Quad Flat Pack (SQFP)

The 80C186EB is a second generation CHMOS High-Integration microprocessor. It has features that are new to the 80C186 family and include a STATIC CPU core, an enhanced Chip Select decode unit, two independent Serial Channels, I/O ports, and the capability of Idle or Powerdown low power modes.

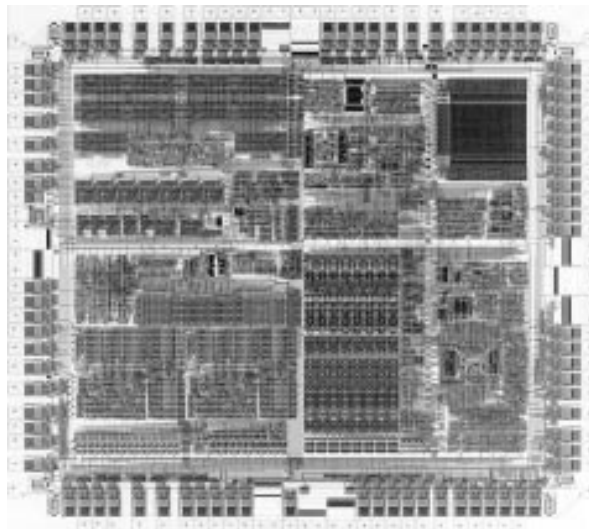

272433-1

\*Other brands and names are the property of their respective owners. Information in this document is provided in connection with Intel products. Intel assumes no liability whatsoever, including infringement of any patent or copyright, for sale and use of Intel products except as provided in Intel's Terms and Conditions of Sale for such products. Intel retains the right to make changes to these specifications at any time, without notice. Microcomputer Products may have minor variations to this specification known as errata.

October 1995

Order Number: 272433-004

COPYRIGHT © INTEL CORPORATION, 1995

# 80C186EB/80C188EB and 80L186EB/80L188EB 16-Bit High-Integration Embedded Processors

<b>CONTENTS</b>	<b>PAGE</b>	<b>CONTENTS</b>	<b>PAGE</b>
<b>INTRODUCTION</b> .....	4	Recommended Connections .....	23
<b>CORE ARCHITECTURE</b> .....	4	<b>DC SPECIFICATIONS</b> .....	24
Bus Interface Unit .....	4	I <sub>CC</sub> versus Frequency and Voltage .....	27
Clock Generator .....	4	PDTMR Pin Delay Calculation .....	27
<b>80C186EC PERIPHERAL ARCHITECTURE</b> .....	5	<b>AC SPECIFICATIONS</b> .....	28
Interrupt Control Unit .....	5	AC Characteristics—80C186EB25 .....	28
Timer/Counter Unit .....	5	AC Characteristics—80C186EB20/13 .....	30
Serial Communications Unit .....	7	AC Characteristics—80L186EB16 .....	32
Chip-Select Unit .....	7	Relative Timings .....	36
I/O Port Unit .....	7	Serial Port Mode 0 Timings .....	37
Refresh Control Unit .....	7	<b>AC TEST CONDITIONS</b> .....	38
Power Management Unit .....	7	<b>AC TIMING WAVEFORMS</b> .....	38
80C187 Interface (80C186EB Only) .....	7	<b>DERATING CURVES</b> .....	41
ONCE Test Mode .....	7	<b>RESET</b> .....	42
<b>PACKAGE INFORMATION</b> .....	8	<b>BUS CYCLE WAVEFORMS</b> .....	45
Prefix Identification .....	8	<b>EXECUTION TIMINGS</b> .....	52
Pin Descriptions .....	8	<b>INSTRUCTION SET SUMMARY</b> .....	53
<b>80C186EB PINOUT</b> .....	14	<b>ERRATA</b> .....	59
<b>PACKAGE THERMAL SPECIFICATIONS</b> .....	22	<b>REVISION HISTORY</b> .....	59
<b>ELECTRICAL SPECIFICATIONS</b> .....	23		
Absolute Maximum Ratings .....	23		

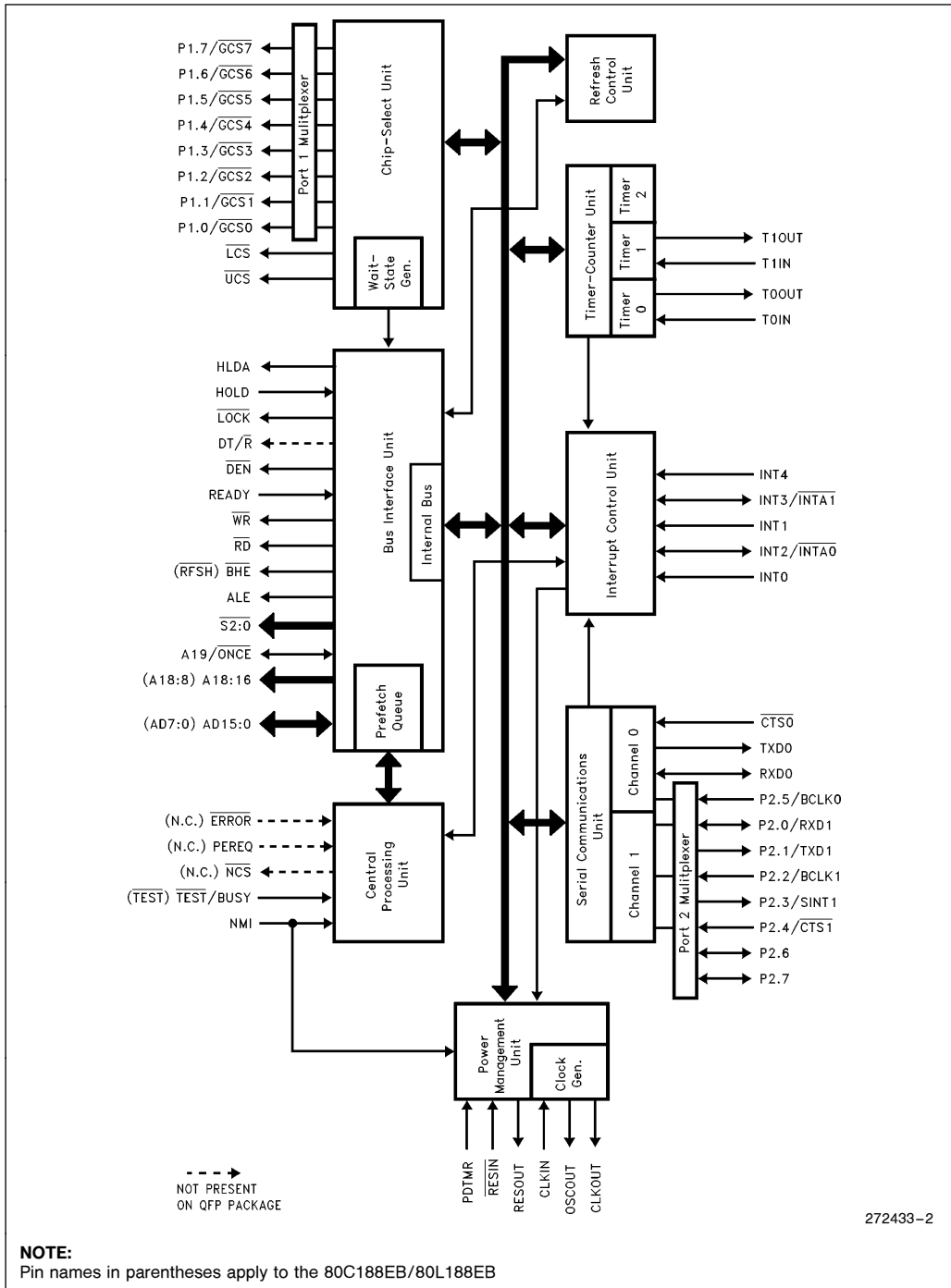

Figure 1. 80C186EB/80C188EB Block Diagram

## INTRODUCTION

Unless specifically noted, all references to the 80C186EB apply to the 80C188EB, 80L186EB, and 80L188EB. References to pins that differ between the 80C186EB/80L186EB and the 80C188EB/80L188EB are given in parentheses. The “L” in the part number denotes low voltage operation. Physically and functionally, the “C” and “L” devices are identical.

The 80C186EB is the first product in a new generation of low-power, high-integration microprocessors. It enhances the existing 186 family by offering new features and new operating modes. The 80C186EB is object code compatible with the 80C186XL/80C188XL microprocessors.

The 80L186EB is the 3V version of the 80C186EB. The 80L186EB is functionally identical to the 80C186EB embedded processor. Current 80C186EB users can easily upgrade their designs to use the 80L186EB and benefit from the reduced power consumption inherent in 3V operation.

The feature set of the 80C186EB meets the needs of low power, space critical applications. Low-Power applications benefit from the static design of the CPU core and the integrated peripherals as well as low voltage operation. Minimum current consumption is achieved by providing a Powerdown mode that halts operation of the device, and freezes the clock circuits. Peripheral design enhancements ensure that non-initialized peripherals consume little current.

Space critical applications benefit from the integration of commonly used system peripherals. Two serial channels are provided for services such as diagnostics, inter-processor communication, modem interface, terminal display interface, and many others. A flexible chip select unit simplifies memory and peripheral interfacing. The interrupt unit provides sources for up to 129 external interrupts and will prioritize these interrupts with those generated from the on-chip peripherals. Three general purpose timer/counters and sixteen multiplexed I/O port pins round out the feature set of the 80C186EB.

Figure 1 shows a block diagram of the 80C186EB/80C188EB. The Execution Unit (EU) is an enhanced 8086 CPU core that includes: dedicated hardware to speed up effective address calculations, enhance execution speed for multiple-bit shift and rotate instructions and for multiply and divide instructions, string move instructions that operate at full bus bandwidth, ten new instruction, and fully static operation. The Bus Interface Unit (BIU) is the same as that found on the original 186 family products, ex-

cept the queue status mode has been deleted and buffer interface control has been changed to ease system design timings. An independent internal bus is used to allow communication between the BIU and internal peripherals.

## CORE ARCHITECTURE

### Bus Interface Unit

The 80C186EB core incorporates a bus controller that generates local bus control signals. In addition, it employs a HOLD/HLDA protocol to share the local bus with other bus masters.

The bus controller is responsible for generating 20 bits of address, read and write strobes, bus cycle status information, and data (for write operations) information. It is also responsible for reading data off the local bus during a read operation. A READY input pin is provided to extend a bus cycle beyond the minimum four states (clocks).

The local bus controller also generates two control signals ( $\overline{DEN}$  and  $DT/\overline{R}$ ) when interfacing to external transceiver chips. (Both  $\overline{DEN}$  and  $DT/\overline{R}$  are available on the PLCC devices, only  $\overline{DEN}$  is available on the QFP and SQFP devices.) This capability allows the addition of transceivers for simple buffering of the multiplexed address/data bus.

### Clock Generator

The processor provides an on-chip clock generator for both internal and external clock generation. The clock generator features a crystal oscillator, a divide-by-two counter, and two low-power operating modes.

The oscillator circuit is designed to be used with either a **parallel resonant** fundamental or third-overtone mode crystal network. Alternatively, the oscillator circuit may be driven from an external clock source. Figure 2 shows the various operating modes of the oscillator circuit.

The crystal or clock frequency chosen must be twice the required processor operating frequency due to the internal divide-by-two counter. This counter is used to drive all internal phase clocks and the external CLKOUT signal. CLKOUT is a 50% duty cycle processor clock and can be used to drive other system components. All AC timings are referenced to CLKOUT.

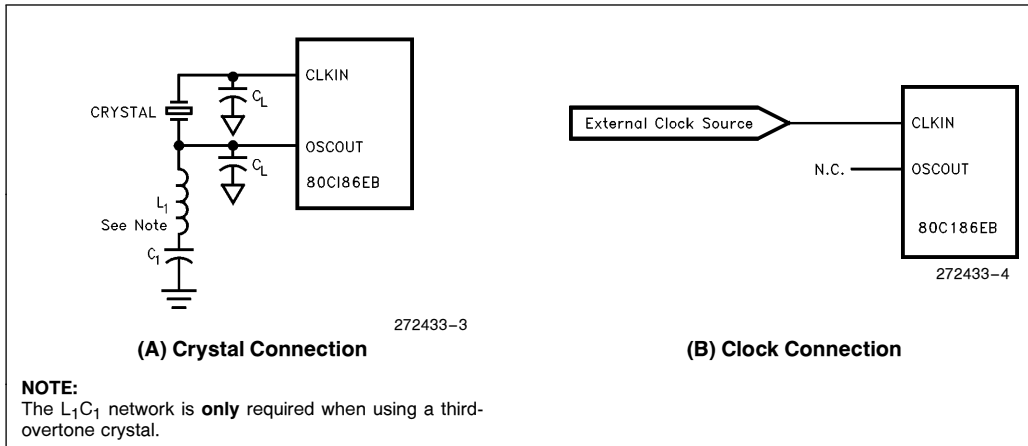

Figure 2. Clock Configurations

The following parameters are recommended when choosing a crystal:

Temperature Range:	Application Specific
ESR (Equivalent Series Resistance):	40Ω max
C <sub>0</sub> (Shunt Capacitance of Crystal):	7.0 pF max
C <sub>L</sub> (Load Capacitance):	20 pF ± 2 pF
Drive Level:	1 mW max

### 80C186EB PERIPHERAL ARCHITECTURE

The 80C186EB has integrated several common system peripherals with a CPU core to create a compact, yet powerful system. The integrated peripherals are designed to be flexible and provide logical interconnections between supporting units (e.g., the interrupt control unit supports interrupt requests from the timer/counters or serial channels).

The list of integrated peripherals includes:

- 7-Input Interrupt Control Unit
- 3-Channel Timer/Counter Unit
- 2-Channel Serial Communications Unit
- 10-Output Chip-Select Unit
- I/O Port Unit
- Refresh Control Unit
- Power Management Unit

The registers associated with each integrated peripheral are contained within a 128 x 16 register file called the Peripheral Control Block (PCB). The PCB can be located in either memory or I/O space on any 256 Byte address boundary.

Figure 3 provides a list of the registers associated with the PCB. The Register Bit Summary at the end of this specification individually lists all of the registers and identifies each of their programming attributes.

### Interrupt Control Unit

The 80C186EB can receive interrupts from a number of sources, both internal and external. The interrupt control unit serves to merge these requests on a priority basis, for individual service by the CPU. Each interrupt source can be independently masked by the Interrupt Control Unit (ICU) or all interrupts can be globally masked by the CPU.

Internal interrupt sources include the Timers and Serial channel 0. External interrupt sources come from the five input pins INT4:0. The NMI interrupt pin is not controlled by the ICU and is passed directly to the CPU. Although the Timer and Serial channel each have only one request input to the ICU, separate vector types are generated to service individual interrupts within the Timer and Serial channel units.

### Timer/Counter Unit

The 80C186EB Timer/Counter Unit (TCU) provides three 16-bit programmable timers. Two of these are highly flexible and are connected to external pins for control or clocking. A third timer is not connected to any external pins and can only be clocked internally. However, it can be used to clock the other two timer channels. The TCU can be used to count external events, time external events, generate non-repetitive waveforms, generate timed interrupts, etc.



PCB Offset	Function	PCB Offset	Function	PCB Offset	Function	PCB Offset	Function
00H	Reserved	40H	Timer2 Count	80H	GCS0 Start	C0H	Reserved
02H	End Of Interrupt	42H	Timer2 Compare	82H	GCS0 Stop	C2H	Reserved
04H	Poll	44H	Reserved	84H	GCS1 Start	C4H	Reserved
06H	Poll Status	46H	Timer2 Control	86H	GCS1 Stop	C6H	Reserved
08H	Interrupt Mask	48H	Reserved	88H	GCS2 Start	C8H	Reserved
0AH	Priority Mask	4AH	Reserved	8AH	GCS2 Stop	CAH	Reserved
0CH	In-Service	4CH	Reserved	8CH	GCS3 Start	CCH	Reserved
0EH	Interrupt Request	4EH	Reserved	8EH	GCS3 Stop	CEH	Reserved
10H	Interrupt Status	50H	Port 1 Direction	90H	GCS4 Start	D0H	Reserved
12H	Timer Control	52H	Port 1 Pin	92H	GCS4 Stop	D2H	Reserved
14H	Serial Control	54H	Port 1 Control	94H	GCS5 Start	D4H	Reserved
16H	INT4 Control	56H	Port 1 Latch	96H	GCS5 Stop	D6H	Reserved
18H	INT0 Control	58H	Port 2 Direction	98H	GCS6 Start	D8H	Reserved
1AH	INT1 Control	5AH	Port 2 Pin	9AH	GCS6 Stop	DAH	Reserved
1CH	INT2 Control	5CH	Port 2 Control	9CH	GCS7 Start	DCH	Reserved
1EH	INT3 Control	5EH	Port 2 Latch	9EH	GCS7 Stop	DEH	Reserved
20H	Reserved	60H	Serial0 Baud	A0H	LCS Start	E0H	Reserved
22H	Reserved	62H	Serial0 Count	A2H	LCS Stop	E2H	Reserved
24H	Reserved	64H	Serial0 Control	A4H	UCS Start	E4H	Reserved
26H	Reserved	66H	Serial0 Status	A6H	UCS Stop	E6H	Reserved
28H	Reserved	68H	Serial0 RBUF	A8H	Relocation	E8H	Reserved
2AH	Reserved	6AH	Serial0 TBUF	AAH	Reserved	EAH	Reserved
2CH	Reserved	6CH	Reserved	ACH	Reserved	ECH	Reserved
2EH	Reserved	6EH	Reserved	AEH	Reserved	EEH	Reserved
30H	Timer0 Count	70H	Serial1 Baud	B0H	Refresh Base	F0H	Reserved
32H	Timer0 Compare A	72H	Serial1 Count	B2H	Refresh Time	F2H	Reserved
34H	Timer0 Compare B	74H	Serial1 Control	B4H	Refresh Control	F4H	Reserved
36H	Timer0 Control	76H	Serial1 Status	B6H	Reserved	F6H	Reserved
38H	Timer1 Count	78H	Serial1 RBUF	B8H	Power Control	F8H	Reserved
3AH	Timer1 Compare A	7AH	Serial1 TBUF	BAH	Reserved	FAH	Reserved
3CH	Timer1 Compare B	7CH	Reserved	BCH	Step ID	FCH	Reserved
3EH	Timer1 Control	7EH	Reserved	BEH	Reserved	FEH	Reserved

Figure 3. Peripheral Control Block Registers



## 80C186EB/80C188EB, 80L186EB/80L188EB

### Serial Communications Unit

The Serial Control Unit (SCU) of the 80C186EB contains two independent channels. Each channel is identical in operation except that only channel 0 is supported by the integrated interrupt controller (channel 1 has an external interrupt pin). Each channel has its own baud rate generator that is independent of the Timer/Counter Unit, and can be internally or externally clocked at up to one half the 80C186EB operating frequency.

Independent baud rate generators are provided for each of the serial channels. For the asynchronous modes, the generator supplies an 8x baud clock to both the receive and transmit register logic. A 1x baud clock is provided in the synchronous mode.

### Chip-Select Unit

The 80C186EB Chip-Select Unit (CSU) integrates logic which provides up to ten programmable chip-selects to access both memories and peripherals. In addition, each chip-select can be programmed to automatically insert additional clocks (wait-states) into the current bus cycle and automatically terminate a bus cycle independent of the condition of the READY input pin.

### I/O Port Unit

The I/O Port Unit (IPU) on the 80C186EB supports two 8-bit channels of input, output, or input/output operation. Port 1 is multiplexed with the chip select pins and is output only. Most of Port 2 is multiplexed with the serial channel pins. Port 2 pins are limited to either an output or input function depending on the operation of the serial pin it is multiplexed with.

### Refresh Control Unit

The Refresh Control Unit (RCU) automatically generates a periodic memory read bus cycle to keep dynamic or pseudo-static memory refreshed. A 9-bit counter controls the number of clocks between refresh requests.

A 12-bit address generator is maintained by the RCU and is presented on the A12:1 address lines during the refresh bus cycle. Address bits A19:13 are programmable to allow the refresh address block to be located on any 8 Kbyte boundary.

### Power Management Unit

The 80C186EB Power Management Unit (PMU) is provided to control the power consumption of the device. The PMU provides three power modes: Active, Idle, and Powerdown.

Active Mode indicates that all units on the 80C186EB are functional and the device consumes maximum power (depending on the level of peripheral operation). Idle Mode freezes the clocks of the Execution and Bus units at a logic zero state (all peripherals continue to operate normally).

The Powerdown mode freezes all internal clocks at a logic zero level and disables the crystal oscillator. All internal registers hold their values provided  $V_{CC}$  is maintained. Current consumption is reduced to just transistor junction leakage.

### 80C187 Interface (80C186EB Only)

The 80C186EB (PLCC package only) supports the direct connection of the 80C187 Numerics Coprocessor.

### ONCE Test Mode

To facilitate testing and inspection of devices when fixed into a target system, the 80C186EB has a test mode available which forces all output and input/output pins to be placed in the high-impedance state. ONCE stands for "ON Circuit Emulation". The ONCE mode is selected by forcing the A19/ONCE pin LOW (0) during a processor reset (this pin is weakly held to a HIGH (1) level) while  $\overline{RESIN}$  is active.

## PACKAGE INFORMATION

This section describes the pins, pinouts, and thermal characteristics for the 80C186EB in the Plastic Leaded Chip Carrier (PLCC) package, Shrink Quad Flat Pack (SQFP), and Quad Flat Pack (QFP) package. For complete package specifications and information, see the Intel Packaging Outlines and Dimensions Guide (Order Number: 231369).

### Prefix Identification

With the extended temperature range, operational characteristics are guaranteed over the temperature range corresponding to  $-40^{\circ}\text{C}$  to  $+85^{\circ}\text{C}$  ambient. Package types are identified by a two-letter prefix to the part number. The prefixes are listed in Table 1.

**Table 1. Prefix Identification**

Prefix	Note	Package Type	Temperature Type
TN		PLCC	Extended
TS		QFP (EIAJ)	Extended
SB	1	SQFP	Extended/Commercial
N	1	PLCC	Commercial
S	1	QFP (EIAJ)	Commercial

**NOTE:**

1. The 5V 25 MHz and 3V 16 MHz versions are only available in commercial temperature range corresponding to  $0^{\circ}\text{C}$  to  $+70^{\circ}\text{C}$  ambient.

### Pin Descriptions

Each pin or logical set of pins is described in Table 3. There are three columns for each entry in the Pin Description Table.

The **Pin Name** column contains a mnemonic that describes the pin function. Negation of the signal name (for example, RESIN) denotes a signal that is active low.

The **Pin Type** column contains two kinds of information. The first symbol indicates whether a pin is power (P), ground (G), input only (I), output only (O) or input/output (I/O). Some pins have multiplexed functions (for example, A19/S6). Additional symbols indicate additional characteristics for each pin. Table 2 lists all the possible symbols for this column.

The **Input Type** column indicates the type of input (Asynchronous or Synchronous).

Asynchronous pins require that setup and hold times be met only in order to guarantee *recognition* at a particular clock edge. Synchronous pins require that setup and hold times be met to guarantee proper *operation*. For example, missing the setup or hold time for the SRDY pin (a synchronous input) will result in a system failure or lockup. Input pins may also be edge- or level-sensitive. The possible characteristics for input pins are S(E), S(L), A(E) and A(L).

The **Output States** column indicates the output state as a function of the device operating mode. Output states are dependent upon the current activity of the processor. There are four operational states that are different from regular operation: bus hold, reset, Idle Mode and Powerdown Mode. Appropriate characteristics for these states are also indicated in this column, with the legend for all possible characteristics in Table 2.

The **Pin Description** column contains a text description of each pin.

As an example, consider AD15:0. I/O signifies the pins are bidirectional. S(L) signifies that the input function is synchronous and level-sensitive. H(Z) signifies that, as outputs, the pins are high-impedance upon acknowledgement of bus hold. R(Z) signifies that the pins float during reset. P(X) signifies that the pins retain their states during Powerdown Mode.



**Table 2. Pin Description Nomenclature**

Symbol	Description
P	Power Pin (Apply +V <sub>CC</sub> Voltage)
G	Ground (Connect to V <sub>SS</sub> )
I	Input Only Pin
O	Output Only Pin
I/O	Input/Output Pin
S(E)	Synchronous, Edge Sensitive
S(L)	Synchronous, Level Sensitive
A(E)	Asynchronous, Edge Sensitive
A(L)	Asynchronous, Level Sensitive
H(1)	Output Driven to V <sub>CC</sub> during Bus Hold
H(0)	Output Driven to V <sub>SS</sub> during Bus Hold
H(Z)	Output Floats during Bus Hold
H(Q)	Output Remains Active during Bus Hold
H(X)	Output Retains Current State during Bus Hold
R(WH)	Output Weakly Held at V <sub>CC</sub> during Reset
R(1)	Output Driven to V <sub>CC</sub> during Reset
R(0)	Output Driven to V <sub>SS</sub> during Reset
R(Z)	Output Floats during Reset
R(Q)	Output Remains Active during Reset
R(X)	Output Retains Current State during Reset
I(1)	Output Driven to V <sub>CC</sub> during Idle Mode
I(0)	Output Driven to V <sub>SS</sub> during Idle Mode
I(Z)	Output Floats during Idle Mode
I(Q)	Output Remains Active during Idle Mode
I(X)	Output Retains Current State during Idle Mode
P(1)	Output Driven to V <sub>CC</sub> during Powerdown Mode
P(0)	Output Driven to V <sub>SS</sub> during Powerdown Mode
P(Z)	Output Floats during Powerdown Mode
P(Q)	Output Remains Active during Powerdown Mode
P(X)	Output Retains Current State during Powerdown Mode

Table 3. Pin Descriptions

Pin Name	Pin Type	Input Type	Output States	Description
V <sub>CC</sub>	P	—	—	<b>POWER</b> connections consist of four pins which must be shorted externally to a V <sub>CC</sub> board plane.
V <sub>SS</sub>	G	—	—	<b>GROUND</b> connections consist of six pins which must be shorted externally to a V <sub>SS</sub> board plane.
CLKIN	I	A(E)	—	<b>CLock INput</b> is an input for an external clock. An external oscillator operating at two times the required processor operating frequency can be connected to CLKIN. For crystal operation, CLKIN (along with OSCOUT) are the crystal connections to an internal Pierce oscillator.
OSCOUT	O	—	H(Q) R(Q) P(Q)	<b>OSCillator OUTput</b> is only used when using a crystal to generate the external clock. OSCOUT (along with CLKIN) are the crystal connections to an internal Pierce oscillator. This pin is not to be used as 2X clock output for non-crystal applications (i.e., this pin is N.C. for non-crystal applications). OSCOUT does not float in ONCE mode.
CLKOUT	O	—	H(Q) R(Q) P(Q)	<b>CLock OUTput</b> provides a timing reference for inputs and outputs of the processor, and is one-half the input clock (CLKIN) frequency. CLKOUT has a 50% duty cycle and transitions every falling edge of CLKIN.
$\overline{\text{RESIN}}$	I	A(L)	—	<b>RESet IN</b> causes the processor to immediately terminate any bus cycle in progress and assume an initialized state. All pins will be driven to a known state, and RESOUT will also be driven active. The rising edge (low-to-high) transition synchronizes CLKOUT with CLKIN before the processor begins fetching opcodes at memory location 0FFFF0H.
RESOUT	O	—	H(0) R(1) P(0)	<b>RESet OUTput</b> that indicates the processor is currently in the reset state. RESOUT will remain active as long as $\overline{\text{RESIN}}$ remains active.
PDTMR	I/O	A(L)	H(WH) R(Z) P(1)	<b>Power-Down TiMeR</b> pin (normally connected to an external capacitor) that determines the amount of time the processor waits after an exit from power down before resuming normal operation. The duration of time required will depend on the startup characteristics of the crystal oscillator.
NMI	I	A(E)	—	<b>Non-Maskable Interrupt</b> input causes a TYPE-2 interrupt to be serviced by the CPU. NMI is latched internally.
$\overline{\text{TEST}}/\text{BUSY}$ ( $\overline{\text{TEST}}$ )	I	A(E)	—	<b>TEST</b> is used during the execution of the WAIT instruction to suspend CPU operation until the pin is sampled active (LOW). $\overline{\text{TEST}}$ is alternately known as BUSY when interfacing with an 80C187 numerics coprocessor (80C186EB only).
AD15:0 (AD7:0)	I/O	S(L)	H(Z) R(Z) P(X)	These pins provide a multiplexed <b>Address</b> and <b>Data</b> bus. During the address phase of the bus cycle, address bits 0 through 15 (0 through 7 on the 80C188EB) are presented on the bus and can be latched using ALE. 8- or 16-bit data information is transferred during the data phase of the bus cycle.

**NOTE:**

Pin names in parentheses apply to the 80C188EB/80L188EB.

**Table 3. Pin Descriptions** (Continued)

Pin Name	Pin Type	Input Type	Output States	Description																																				
A18:16 A19/ $\overline{\text{ONCE}}$ (A15:A8) (A18:16) (A19/ $\overline{\text{ONCE}}$ )	I/O	A(L)	H(Z) R(WH) P(X)	These pins provide multiplexed <b>Address</b> during the address phase of the bus cycle. Address bits 16 through 19 are presented on these pins and can be latched using ALE. These pins are driven to a logic 0 during the data phase of the bus cycle. On the 80C188EB, A15–A8 provide valid address information for the entire bus cycle. During a processor reset (RESIN active), A19/ $\overline{\text{ONCE}}$ is used to enable ONCE mode. A18:16 must not be driven low during reset or improper operation may result.																																				
$\overline{\text{S}}2:0$	O	—	H(Z) R(Z) P(1)	<p>Bus cycle <b>Status</b> are encoded on these pins to provide bus transaction information. <math>\overline{\text{S}}2:0</math> are encoded as follows:</p> <table border="1"> <thead> <tr> <th><math>\overline{\text{S}}2</math></th> <th><math>\overline{\text{S}}1</math></th> <th><math>\overline{\text{S}}0</math></th> <th>Bus Cycle Initiated</th> </tr> </thead> <tbody> <tr> <td>0</td> <td>0</td> <td>0</td> <td>Interrupt Acknowledge</td> </tr> <tr> <td>0</td> <td>0</td> <td>1</td> <td>Read I/O</td> </tr> <tr> <td>0</td> <td>1</td> <td>0</td> <td>Write I/O</td> </tr> <tr> <td>0</td> <td>1</td> <td>1</td> <td>Processor HALT</td> </tr> <tr> <td>1</td> <td>0</td> <td>0</td> <td>Queue Instruction Fetch</td> </tr> <tr> <td>1</td> <td>0</td> <td>1</td> <td>Read Memory</td> </tr> <tr> <td>1</td> <td>1</td> <td>0</td> <td>Write Memory</td> </tr> <tr> <td>1</td> <td>1</td> <td>1</td> <td>Passive (no bus activity)</td> </tr> </tbody> </table>	$\overline{\text{S}}2$	$\overline{\text{S}}1$	$\overline{\text{S}}0$	Bus Cycle Initiated	0	0	0	Interrupt Acknowledge	0	0	1	Read I/O	0	1	0	Write I/O	0	1	1	Processor HALT	1	0	0	Queue Instruction Fetch	1	0	1	Read Memory	1	1	0	Write Memory	1	1	1	Passive (no bus activity)
$\overline{\text{S}}2$	$\overline{\text{S}}1$	$\overline{\text{S}}0$	Bus Cycle Initiated																																					
0	0	0	Interrupt Acknowledge																																					
0	0	1	Read I/O																																					
0	1	0	Write I/O																																					
0	1	1	Processor HALT																																					
1	0	0	Queue Instruction Fetch																																					
1	0	1	Read Memory																																					
1	1	0	Write Memory																																					
1	1	1	Passive (no bus activity)																																					
ALE	O	—	H(0) R(0) P(0)	<b>Address Latch Enable</b> output is used to strobe address information into a transparent type latch during the address phase of the bus cycle.																																				
$\overline{\text{B}}\overline{\text{H}}\overline{\text{E}}$ ( $\overline{\text{R}}\overline{\text{F}}\overline{\text{S}}\overline{\text{H}}$ )	O	—	H(Z) R(Z) P(X)	<p><b>Byte High Enable</b> output to indicate that the bus cycle in progress is transferring data over the upper half of the data bus. <math>\overline{\text{B}}\overline{\text{H}}\overline{\text{E}}</math> and A0 have the following logical encoding</p> <table border="1"> <thead> <tr> <th>A0</th> <th><math>\overline{\text{B}}\overline{\text{H}}\overline{\text{E}}</math></th> <th>Encoding (for the 80C186EB/80L186EB only)</th> </tr> </thead> <tbody> <tr> <td>0</td> <td>0</td> <td>Word Transfer</td> </tr> <tr> <td>0</td> <td>1</td> <td>Even Byte Transfer</td> </tr> <tr> <td>1</td> <td>0</td> <td>Odd Byte Transfer</td> </tr> <tr> <td>1</td> <td>1</td> <td>Refresh Operation</td> </tr> </tbody> </table> <p>On the 80C188EB/80L188EB, <math>\overline{\text{R}}\overline{\text{F}}\overline{\text{S}}\overline{\text{H}}</math> is asserted low to indicate a refresh bus cycle.</p>	A0	$\overline{\text{B}}\overline{\text{H}}\overline{\text{E}}$	Encoding (for the 80C186EB/80L186EB only)	0	0	Word Transfer	0	1	Even Byte Transfer	1	0	Odd Byte Transfer	1	1	Refresh Operation																					
A0	$\overline{\text{B}}\overline{\text{H}}\overline{\text{E}}$	Encoding (for the 80C186EB/80L186EB only)																																						
0	0	Word Transfer																																						
0	1	Even Byte Transfer																																						
1	0	Odd Byte Transfer																																						
1	1	Refresh Operation																																						
$\overline{\text{R}}\overline{\text{D}}$	O	—	H(Z) R(Z) P(1)	<b>ReaD</b> output signals that the accessed memory or I/O device must drive data information onto the data bus.																																				
$\overline{\text{W}}\overline{\text{R}}$	O	—	H(Z) R(Z) P(1)	<b>WRite</b> output signals that data available on the data bus are to be written into the accessed memory or I/O device.																																				
READY	I	A(L) S(L)	—	<b>READY</b> input to signal the completion of a bus cycle. READY must be active to terminate any bus cycle, unless it is ignored by correctly programming the Chip-Select Unit.																																				
$\overline{\text{D}}\overline{\text{E}}\overline{\text{N}}$	O	—	H(Z) R(Z) P(1)	<b>Data ENable</b> output to control the enable of bi-directional transceivers in a buffered system. $\overline{\text{D}}\overline{\text{E}}\overline{\text{N}}$ is active only when data is to be transferred on the bus.																																				

**NOTE:**

Pin names in parentheses apply to the 80C188EB/80L188EB.

Table 3. Pin Descriptions (Continued)

Pin Name	Pin Type	Input Type	Output States	Description
DT/ $\bar{R}$	O	—	H(Z) R(Z) P(X)	<b>Data Transmit/Receive</b> output controls the direction of a bi-directional buffer in a buffered system. DT/ $\bar{R}$ is only available for the PLCC package.
$\bar{LOCK}$	O	—	H(Z) R(WH) P(1)	<b>LOCK</b> output indicates that the bus cycle in progress is not to be interrupted. The processor will not service other bus requests (such as HOLD) while $\bar{LOCK}$ is active. This pin is configured as a weakly held high input while $\bar{RESIN}$ is active and must not be driven low.
HOLD	I	A(L)	—	<b>HOLD</b> request input to signal that an external bus master wishes to gain control of the local bus. The processor will relinquish control of the local bus between instruction boundaries not conditioned by a LOCK prefix.
HLDA	O	—	H(1) R(0) P(0)	<b>HoLD Acknowledge</b> output to indicate that the processor has relinquished control of the local bus. When HLDA is asserted, the processor will (or has) floated its data bus and control signals allowing another bus master to drive the signals directly.
$\bar{NCS}$ (N.C.)	O	—	H(1) R(1) P(1)	<b>Numerics Coprocessor Select</b> output is generated when accessing a numerics coprocessor. $\bar{NCS}$ is not provided on the QFP or SQFP packages. This signal does not exist on the 80C188EB/80L188EB.
$\bar{ERROR}$ (N.C.)	I	A(L)	—	<b>ERROR</b> input that indicates the last numerics coprocessor operation resulted in an exception condition. An interrupt TYPE 16 is generated if $\bar{ERROR}$ is sampled active at the beginning of a numerics operation. $\bar{ERROR}$ is not provided on the QFP or SQFP packages. This signal does not exist on the 80C188EB/80L188EB.
PEREQ (N.C.)	I	A(L)	—	<b>CoProcessor REQuest</b> signals that a data transfer between an External Numerics Coprocessor and Memory is pending. PEREQ is not provided on the QFP or SQFP packages. This signal does not exist on the 80C188EB/80L188EB.
$\bar{UCS}$	O	—	H(1) R(1) P(1)	<b>Upper Chip Select</b> will go active whenever the address of a memory or I/O bus cycle is within the address limitations programmed by the user. After reset, $\bar{UCS}$ is configured to be active for memory accesses between 0FFC00H and 0FFFFFH.
$\bar{LCS}$	O	—	H(1) R(1) P(1)	<b>Lower Chip Select</b> will go active whenever the address of a memory bus cycle is within the address limitations programmed by the user. $\bar{LCS}$ is inactive after a reset.
P1.0/ $\bar{GCS0}$ P1.1/ $\bar{GCS1}$ P1.2/ $\bar{GCS2}$ P1.3/ $\bar{GCS3}$ P1.4/ $\bar{GCS4}$ P1.5/ $\bar{GCS5}$ P1.6/ $\bar{GCS6}$ P1.7/ $\bar{GCS7}$	O	—	H(X)/H(1) R(1) P(X)/P(1)	These pins provide a multiplexed function. If enabled, each pin can provide a <b>Generic Chip Select</b> output which will go active whenever the address of a memory or I/O bus cycle is within the address limitations programmed by the user. When not programmed as a Chip-Select, each pin may be used as a general purpose output <b>Port</b> . As an output port pin, the value of the pin can be read internally.

**NOTE:**

Pin names in parentheses apply to the 80C188EB/80L188EB.

**Table 3. Pin Descriptions** (Continued)

Pin Name	Pin Type	Input Type	Output States	Description
T0OUT T1OUT	O	—	H(Q) R(1) P(Q)	<b>Timer OUTput</b> pins can be programmed to provide a single clock or continuous waveform generation, depending on the timer mode selected.
T0IN T1IN	I	A(L) A(E)	—	<b>Timer INput</b> is used either as clock or control signals, depending on the timer mode selected.
INT0 INT1 INT4	I	A(E,L)	—	Maskable <b>INTerrupt</b> input will cause a vector to a specific Type interrupt routine. To allow interrupt expansion, INT0 and/or INT1 can be used with $\overline{\text{INTA0}}$ and $\overline{\text{INTA1}}$ to interface with an external slave controller.
INT2/ $\overline{\text{INTA0}}$ INT3/ $\overline{\text{INTA1}}$	I/O	A(E,L)	H(1) R(Z) P(1)	These pins provide a multiplexed function. As inputs, they provide a maskable <b>INTerrupt</b> that will cause the CPU to vector to a specific Type interrupt routine. As outputs, each is programmatically controlled to provide an INTERRUPT ACKNOWLEDGE handshake signal to allow interrupt expansion.
P2.7 P2.6	I/O	A(L)	H(X) R(Z) P(X)	BI-DIRECTIONAL, open-drain <b>Port</b> pins.
$\overline{\text{CTS0}}$ P2.4/ $\overline{\text{CTS1}}$	I	A(L)	—	<b>Clear-To-Send</b> input is used to prevent the transmission of serial data on their respective TXD signal pin. $\overline{\text{CTS1}}$ is multiplexed with an input only port function.
TXD0 P2.1/TXD1	O	—	H(X)/H(Q) R(1) P(X)/P(Q)	<b>Transmit Data</b> output provides serial data information. TXD1 is multiplexed with an output only <b>Port</b> function. During synchronous serial communications, TXD will function as a clock output.
RXD0 P2.0/RXD1	I/O	A(L)	R(Z) H(Q) P(X)	<b>Receive Data</b> input accepts serial data information. RXD1 is multiplexed with an input only <b>Port</b> function. During synchronous serial communications, RXD is bi-directional and will become an output for transmission or data (TXD becomes the clock).
P2.5/BCLK0 P2.2/BCLK1	I	A(L)/A(E)	—	<b>Baud Clock</b> input can be used as an alternate clock source for each of the integrated serial channels. BCLKx is multiplexed with an input only <b>Port</b> function, and cannot exceed a clock rate greater than one-half the operating frequency of the processor.
P2.3/SINT1	O	—	H(X)/H(Q) R(0) P(X)/P(X)	<b>Serial INTerrupt</b> output will go active to indicate serial channel 1 requires service. SINT1 is multiplexed with an output only <b>Port</b> function.

**NOTE:**

Pin names in parentheses apply to the 80C188EB/80L188EB.

## 80C186EB PINOUT

Tables 4 and 5 list the 80C186EB/80C188EB pin names with package location for the 84-pin Plastic Leaded Chip Carrier (PLCC) component. Figure 5 depicts the complete 80C186EB/80C188EB pinout (PLCC package) as viewed from the top side of the component (i.e., contacts facing down).

Tables 6 and 7 list the 80C186EB/80C188EB pin names with package location for the 80-pin Quad Flat Pack (QFP) component. Figure 6 depicts the complete 80C186EB/80C188EB (QFP package) as viewed from the top side of the component (i.e., contacts facing down).

Tables 8 and 9 list the 80186EB/80188EB pin names with package location for the 80-pin Shrink Quad Flat Pack (SQFP) component. Figure 7 depicts the complete 80C186EB/80C188EB (SQFP package) as viewed from the top side of the component (i.e., contacts facing down).

**Table 4. PLCC Pin Names with Package Location**

Address/Data Bus		Bus Control		Processor Control		I/O	
Name	Location	Name	Location	Name	Location	Name	Location
AD0	61	ALE	6	RESIN	37	UCS	30
AD1	66	$\overline{\text{BHE}}$ (RFSH)	7	RESOUT	38	$\overline{\text{LCS}}$	29
AD2	68	$\overline{\text{S0}}$	10	CLKIN	41	$\overline{\text{P1.0/GCS0}}$	28
AD3	70	$\overline{\text{S1}}$	9	OSCOU	40	$\overline{\text{P1.1/GCS1}}$	27
AD4	72	$\overline{\text{S2}}$	8	CLKOUT	44	$\overline{\text{P1.2/GCS2}}$	26
AD5	74	$\overline{\text{RD}}$	4	$\overline{\text{TEST/BUSY}}$	14	$\overline{\text{P1.3/GCS3}}$	25
AD6	76	$\overline{\text{WR}}$	5	$\overline{\text{NCS}}$ (N.C.)	60	$\overline{\text{P1.4/GCS4}}$	24
AD7	78	READY	18	PEREQ (N.C.)	39	$\overline{\text{P1.5/GCS5}}$	21
AD8 (A8)	62	$\overline{\text{DEN}}$	11	ERROR (N.C.)	3	$\overline{\text{P1.6/GCS6}}$	20
AD9 (A9)	67	$\overline{\text{DT/R}}$	16	PDTMR	36	$\overline{\text{P1.7/GCS7}}$	19
AD10 (A10)	69	$\overline{\text{LOCK}}$	15	NMI	17	T0OUT	45
AD11 (A11)	71	HOLD	13	INT0	31	T0IN	46
AD12 (A12)	73	HLDA	12	INT1	32	T1OUT	47
AD13 (A13)	75			INT2/ $\overline{\text{INTA0}}$	33	T1IN	48
AD14 (A14)	77			INT3/ $\overline{\text{INTA1}}$	34	RXD0	53
AD15 (A15)	79			INT4	35	TXD0	52
A16	80					$\overline{\text{P2.5/BCLK0}}$	54
A17	81					$\overline{\text{CTS0}}$	51
A18	82					$\overline{\text{P2.0/RXD1}}$	57
A19/ $\overline{\text{ONCE}}$	83					$\overline{\text{P2.1/TXD1}}$	58
						$\overline{\text{P2.2/BCLK1}}$	59
						$\overline{\text{P2.3/SINT1}}$	55
						$\overline{\text{P2.4/CTS1}}$	56
						P2.6	50
						P2.7	49

**NOTE:**

Pin names in parentheses apply to the 80C188EB/80L188EB.



Table 5. PLCC Package Locations with Pin Name

Location	Name	Location	Name	Location	Name	Location	Name
1	V <sub>CC</sub>	22	V <sub>SS</sub>	43	V <sub>SS</sub>	64	V <sub>CC</sub>
2	V <sub>SS</sub>	23	V <sub>CC</sub>	44	CLKOUT	65	V <sub>SS</sub>
3	$\overline{\text{ERROR}}$ (N.C.)	24	P1.4/ $\overline{\text{GCS4}}$	45	T0OUT	66	AD1
4	$\overline{\text{RD}}$	25	P1.3/ $\overline{\text{GCS3}}$	46	T0IN	67	AD9 (A9)
5	$\overline{\text{WR}}$	26	P1.2/ $\overline{\text{GCS2}}$	47	T1OUT	68	AD2
6	ALE	27	P1.1/ $\overline{\text{GCS1}}$	48	T1IN	69	AD10 (A10)
7	$\overline{\text{BHE}}$ (RFSH)	28	P1.0/ $\overline{\text{GCS0}}$	49	P2.7	70	AD3
8	$\overline{\text{S2}}$	29	$\overline{\text{LCS}}$	50	P2.6	71	AD11 (A11)
9	$\overline{\text{S1}}$	30	$\overline{\text{UCS}}$	51	$\overline{\text{CTS0}}$	72	AD4
10	$\overline{\text{S0}}$	31	INT0	52	TXD0	73	AD12 (A12)
11	$\overline{\text{DEN}}$	32	INT1	53	RXD0	74	AD5
12	HLDA	33	INT2/ $\overline{\text{INTA0}}$	54	P2.5/BCLK0	75	AD13 (A13)
13	HOLD	34	INT3/ $\overline{\text{INTA1}}$	55	P2.3/SINT1	76	AD6
14	$\overline{\text{TEST}}/\text{BUSY}$	35	INT4	56	P2.4/ $\overline{\text{CTS1}}$	77	AD14 (A14)
15	$\overline{\text{LOCK}}$	36	PDTMR	57	P2.0/RXD1	78	AD7
16	DT/ $\overline{\text{R}}$	37	$\overline{\text{RESIN}}$	58	P2.1/TXD1	79	AD15 (A15)
17	NMI	38	RESOUT	59	P2.2/BCLK1	80	A16
18	READY	39	PEREQ (N.C.)	60	$\overline{\text{NCS}}$ (N.C.)	81	A17
19	P1.7/ $\overline{\text{GCS7}}$	40	OSCOU	61	AD0	82	A18
20	P1.6/ $\overline{\text{GCS6}}$	41	CLKIN	62	AD8 (A8)	83	A19/ $\overline{\text{ONCE}}$
21	P1.5/ $\overline{\text{GCS5}}$	42	V <sub>CC</sub>	63	V <sub>SS</sub>	84	V <sub>SS</sub>

**NOTE:**  
Pin names in parentheses apply to the 80C188EB/80L188EB.

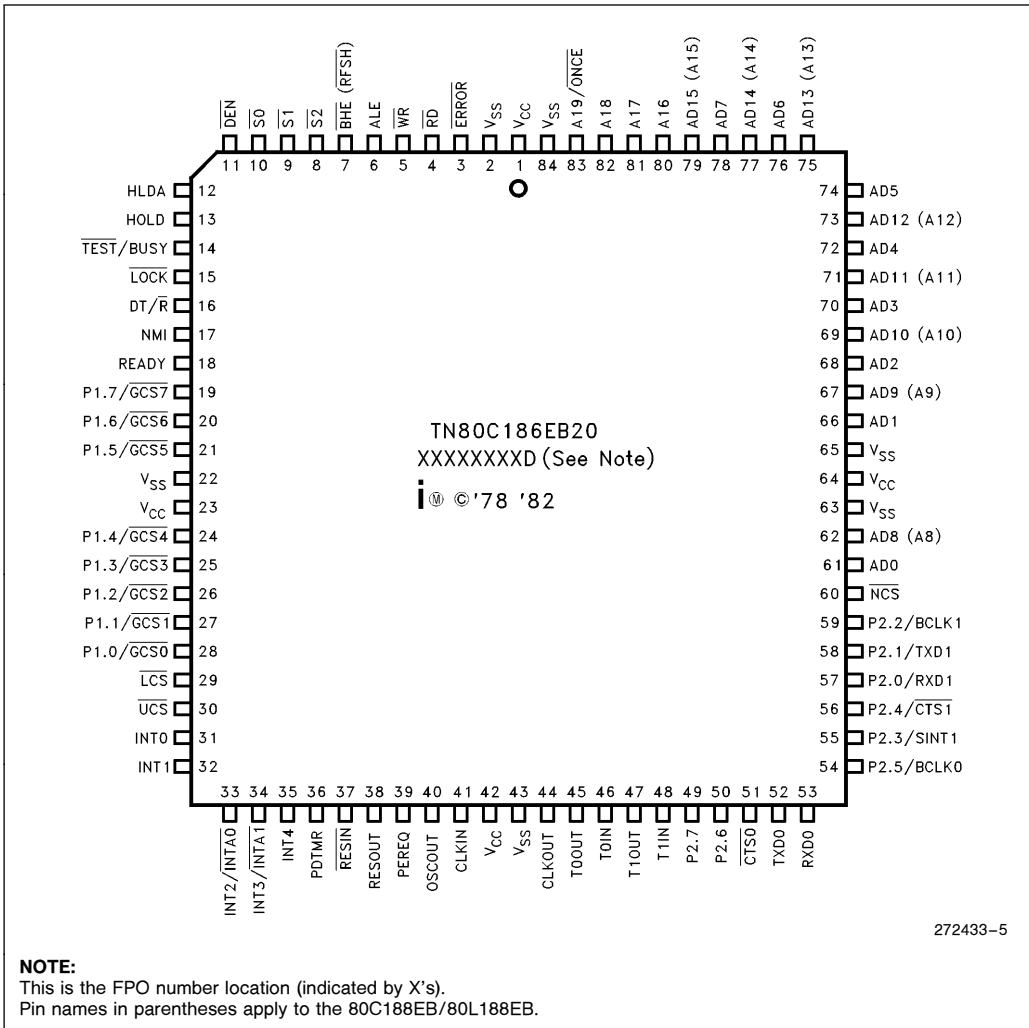

Figure 4. 84-Pin Plastic Leaded Chip Carrier Pinout Diagram



**Table 6. QFP Pin Name with Package Location**

Address/Data Bus		Bus Control		Processor Control		I/O	
Name	Location	Name	Location	Name	Location	Name	Location
AD0	10	ALE	38	RESIN	68	UCS	61
AD1	15	BHE (RFSH)	39	RESOUT	69	LCS	60
AD2	17	S0	42	CLKIN	71	P1.0/GCS0	59
AD3	19	S1	41	OSCOU	70	P1.1/GCS1	58
AD4	21	S2	40	CLKOUT	74	P1.2/GCS2	57
AD5	23	RD	36	TEST	46	P1.3/GCS3	56
AD6	25	WR	37	PDTMR	67	P1.4/GCS4	55
AD7	27	READY	49	NMI	48	P1.5/GCS5	52
AD8 (A8)	11	DEN	43	INT0	62	P1.6/GCS6	51
AD9 (A9)	16	LOCK	47	INT1	63	P1.7/GCS7	50
AD10 (A10)	18	HOLD	45	INT2/INTA0	64	T0OUT	75
AD11 (A11)	20	HLDA	44	INT3/INTA1	65	T0IN	76
AD12 (A12)	22			INT4	66	T1OUT	77
AD13 (A13)	24					T1IN	78
AD14 (A14)	26					RXD0	3
AD15 (A15)	28					TXD0	2
A16	29					P2.5/BCLK0	4
A17	30					CTS0	1
A18	31					P2.0/RXD1	7
A19/ONCE	32					P2.1/TXD1	8
						P2.2/BCLK1	9
						P2.3/SINT1	5
						P2.4/CTS1	6
						P2.6	80
						P2.7	79

Power	
Name	Location
V <sub>SS</sub>	12, 14, 33 35, 53, 73
V <sub>CC</sub>	13, 34 54, 72

**NOTE:**  
Pin names in parentheses apply to the 80C188EB/80L188EB.

Table 7. QFP Package Location with Pin Names

Location	Name	Location	Name	Location	Name	Location	Name
1	$\overline{\text{CTS0}}$	21	AD4	41	$\overline{\text{S1}}$	61	$\overline{\text{UCS}}$
2	TXD0	22	AD12 (A12)	42	$\overline{\text{S0}}$	62	INT0
3	RXD0	23	AD5	43	$\overline{\text{DEN}}$	63	INT1
4	P2.5/ $\overline{\text{BCLK0}}$	24	AD13 (A13)	44	HLDA	64	$\overline{\text{INT2/INTA0}}$
5	P2.3/ $\overline{\text{SINT1}}$	25	AD6	45	HOLD	65	$\overline{\text{INT3/INTA1}}$
6	P2.4/ $\overline{\text{CTST}}$	26	AD14 (A14)	46	$\overline{\text{TEST}}$	66	INT4
7	P2.0/ $\overline{\text{RXD1}}$	27	AD7	47	$\overline{\text{LOCK}}$	67	PDTMR
8	P2.1/ $\overline{\text{TXD1}}$	28	AD15 (A15)	48	NMI	68	$\overline{\text{RESIN}}$
9	P2.2/ $\overline{\text{BCLK1}}$	29	A16	49	READY	69	RESOUT
10	AD0	30	A17	50	P1.7/ $\overline{\text{GCS7}}$	70	OSCOU
11	AD8 (A8)	31	A18	51	P1.6/ $\overline{\text{GCS6}}$	71	CLKIN
12	$\overline{\text{VSS}}$	32	A19/ $\overline{\text{ONCE}}$	52	P1.5/ $\overline{\text{GCS5}}$	72	$\overline{\text{VCC}}$
13	$\overline{\text{VCC}}$	33	$\overline{\text{VSS}}$	53	$\overline{\text{VSS}}$	73	$\overline{\text{VSS}}$
14	$\overline{\text{VSS}}$	34	$\overline{\text{VCC}}$	54	$\overline{\text{VCC}}$	74	CLKOUT
15	AD1	35	$\overline{\text{VSS}}$	55	P1.4/ $\overline{\text{GCS4}}$	75	TOOUT
16	AD9 (A9)	36	$\overline{\text{RD}}$	56	P1.3/ $\overline{\text{GCS3}}$	76	TOIN
17	AD2	37	$\overline{\text{WR}}$	57	P1.2/ $\overline{\text{GCS2}}$	77	T1OUT
18	AD10 (A10)	38	ALE	58	P1.1/ $\overline{\text{GCS1}}$	78	T1IN
19	AD3	39	$\overline{\text{BHE}}$ (RFSH)	59	P1.0/ $\overline{\text{GCS0}}$	79	P2.7
20	AD11 (A11)	40	$\overline{\text{S2}}$	60	$\overline{\text{LCS}}$	80	P2.6

**NOTE:**

Pin names in parentheses apply to the 80C188EB/80L188EB.

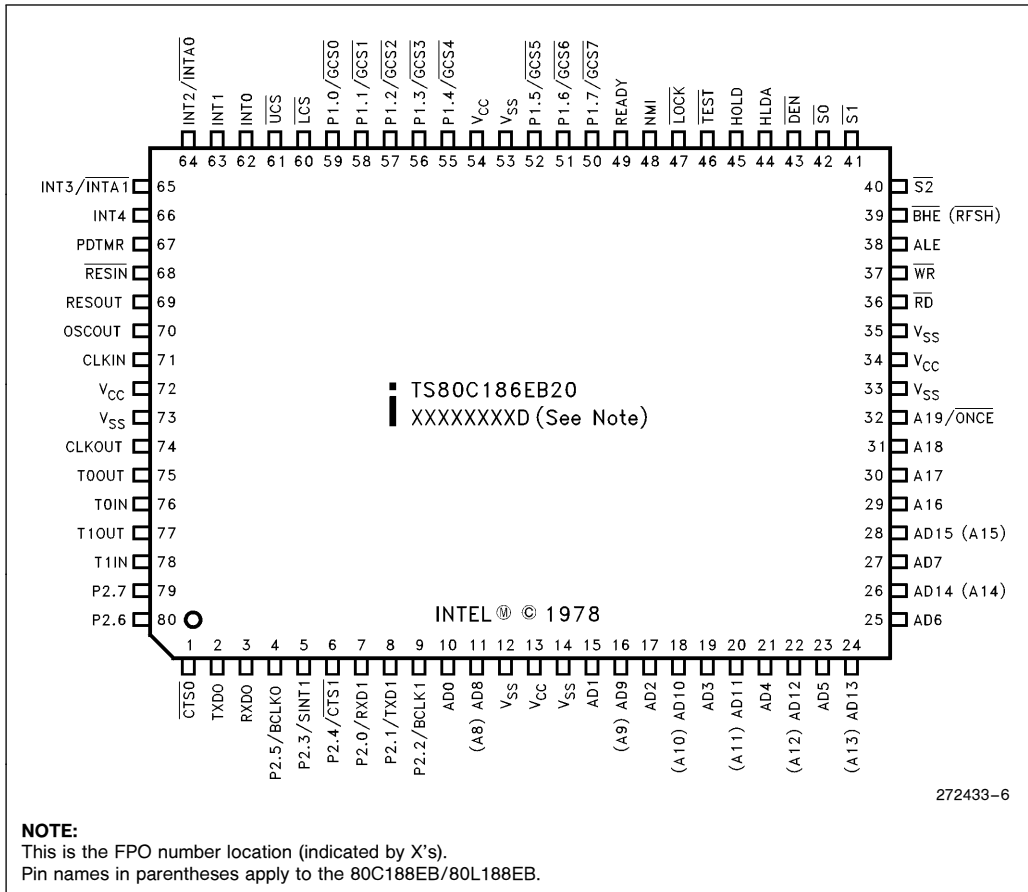

Figure 5. Quad Flat Pack Pinout Diagram

Table 8. SQFP Pin Functions with Location

AD Bus		Bus Control		Processor Control		I/O	
AD0	47	ALE	75	RESIN#	25	UCS#	18
AD1	52	BHE# (RFSH#)	76	RESOUT	26	LCS#	17
AD2	54	S0#	79	CLKIN	28	P1.0/GCS0#	16
AD3	56	S1#	78	OSCOU	27	P1.1/GCS1#	15
AD4	58	S2#	77	CLKOUT	31	P1.2/GCS2#	14
AD5	60	RD#	73	TEST#/BUSY	3	P1.3/GCS3#	13
AD6	62	WR#	74	NMI	5	P1.4/GCS4#	12
AD7	64	READY	6	INT0	19	P1.5/GCS5#	9
AD8 (A8)	48	DEN#	80	INT1	20	P1.6/GCS6#	8
AD9 (A9)	53	LOCK#	4	INT2/INTA0#	21	P1.7/GCS7#	7
AD10 (A10)	55	HOLD	2	INT3/INTA1#	22	P2.0/RXD1	44
AD11 (A11)	57	HLDA	1	INT4	23	P2.1/TXD1	45
AD12 (A12)	59			PDTMR	24	P2.2/BCLK1	46
AD13 (A13)	61					P2.3/SINT1	42
AD14 (A14)	63					P2.4/CTS1#	43
AD15 (A15)	65					P2.5/BCLK0	41
A16	66					P2.6	37
A17	67					P2.7	36
A18	68					CTS0#	38
A19/ONCE	69					TXD0	39
						RXD0	40
						T0IN	33
						T1IN	35
						T0OUT	32
						T1OUT	34

Power and Ground	
V <sub>CC</sub>	11
V <sub>CC</sub>	29
V <sub>CC</sub>	50
V <sub>CC</sub>	71
V <sub>SS</sub>	10
V <sub>SS</sub>	30
V <sub>SS</sub>	49
V <sub>SS</sub>	51
V <sub>SS</sub>	70
V <sub>SS</sub>	72

Table 9. SQFP Pin Locations with Pin Names

1	HLDA	21	INT1/INTA0#	41	P2.5/BCLK0	61	AD13 (A13)
2	HOLD	22	INT3/INTA1#	42	P2.3/SINT1	62	AD6
3	TEST#	23	INT4	43	P2.4/CTS1#	63	AD14 (A14)
4	LOCK#	24	PDTMR	44	P2.0/RXD1	64	AD7
5	NMI	25	RESIN#	45	P2.1/TXD1	65	AD15 (A15)
6	READY	26	RESOUT	46	P2.2/BCLK1	66	A16
7	P1.7/GCS7#	27	OSCOU	47	AD0	67	A17
8	P1.6/GCS6#	28	CLKIN	48	AD8 (A8)	68	A18
9	P1.5/GCS5#	29	V <sub>CC</sub>	49	V <sub>SS</sub>	69	A19/ONCE
10	V <sub>SS</sub>	30	V <sub>SS</sub>	50	V <sub>CC</sub>	70	V <sub>SS</sub>
11	V <sub>CC</sub>	31	CLKOUT	51	V <sub>SS</sub>	71	V <sub>CC</sub>
12	P1.4/GCS4#	32	T0OUT	52	AD1	72	V <sub>SS</sub>
13	P1.3/GCS3#	33	T0IN	53	AD9 (A9)	73	RD#
14	P1.2/GCS2#	34	T1OUT	54	AD2	74	WR#
15	P1.1/GCS1#	35	T1IN	55	AD10 (A10)	75	ALE
16	P1.0/GCS0#	36	P2.7	56	AD3	76	BHE# (RFSH#)
17	LCS#	37	P2.6	57	AD11 (A11)	77	S2#
18	UCS#	38	CTS0#	58	AD4	78	S1#
19	INT0	39	TXD0	59	AD12 (A12)	79	S0#
20	INT1	40	RXD0	60	AD5	80	DEN#

**NOTE:**

Pin names in parentheses apply to the 80C188EB/80L188EB.

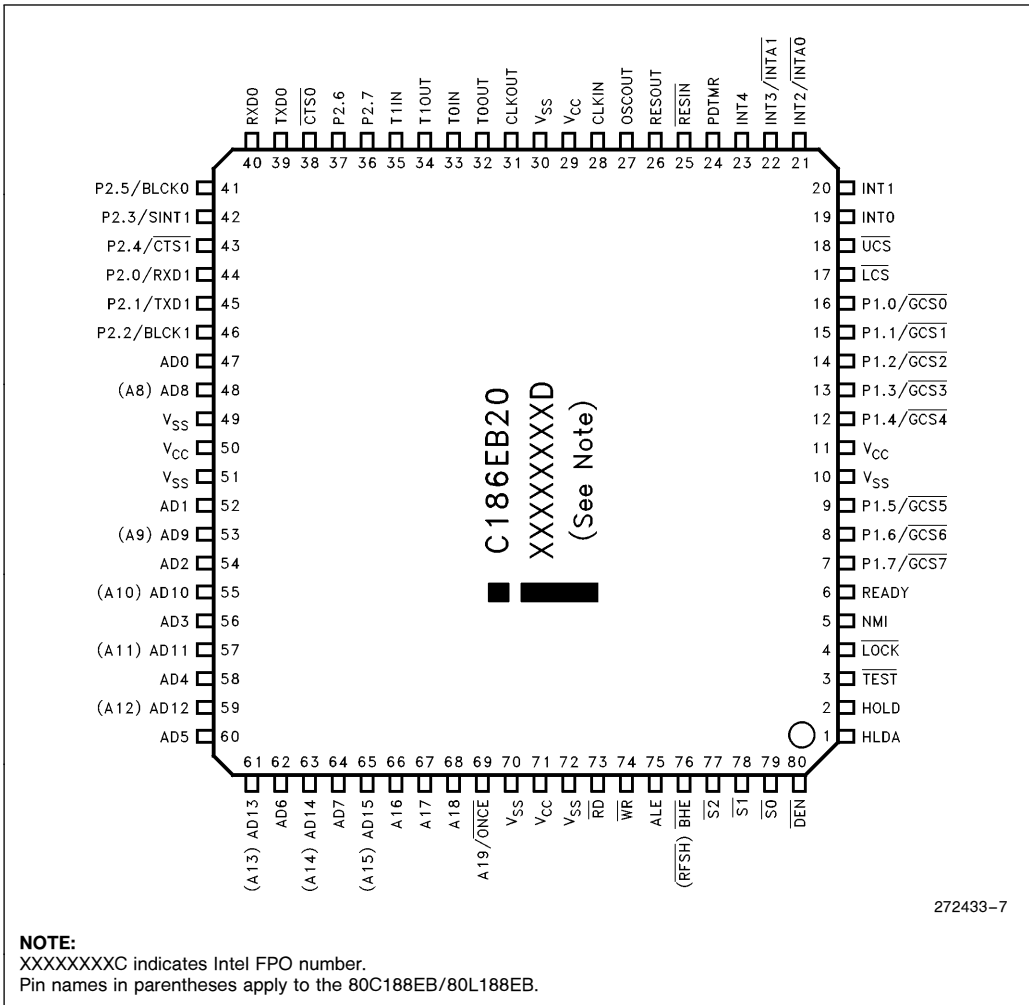

Figure 6. SQFP Package



**PACKAGE THERMAL SPECIFICATIONS**

The 80C186EB/80L186EB is specified for operation when  $T_C$  (the case temperature) is within the range of  $-40^{\circ}\text{C}$  to  $+100^{\circ}\text{C}$  (PLCC package) or  $-40^{\circ}\text{C}$  to  $+114^{\circ}\text{C}$  (QFP package).  $T_C$  may be measured in any environment to determine whether the processor is within the specified operating range. The case temperature must be measured at the center of the top surface.

$T_A$  (the ambient temperature) can be calculated from  $\theta_{CA}$  (thermal resistance from the case to ambient) with the following equation:

$$T_A = T_C - P \cdot \theta_{CA}$$

Typical values for  $\theta_{CA}$  at various airflows are given in Table 10. P (the maximum power consumption, specified in watts) is calculated by using the maximum ICC as tabulated in the DC specifications and  $V_{CC}$  of 5.5V.

**Table 10. Thermal Resistance ( $\theta_{CA}$ ) at Various Airflows (in  $^{\circ}\text{C}/\text{Watt}$ )**

	Airflow Linear ft/min (m/sec)					
	0 (0)	200 (1.01)	400 (2.03)	600 (3.04)	800 (4.06)	1000 (5.07)
$\theta_{CA}$ (PLCC)	30	24	21	19	17	16.5
$\theta_{CA}$ (QFP)	58	47	43	40	38	36
$\theta_{CA}$ (SQFP)	70	TBD	TBD	TBD	TBD	TBD



## ELECTRICAL SPECIFICATIONS

### Absolute Maximum Ratings

Storage Temperature	.....	-65°C to +150°C
Case Temp under Bias	.....	-65°C to +120°C
Supply Voltage		
with Respect to V <sub>SS</sub>	.....	-0.5V to + 6.5V
Voltage on other Pins		
with Respect to V <sub>SS</sub>	.....	-0.5V to V <sub>CC</sub> + 0.5V

### Recommended Connections

Power and ground connections must be made to multiple V<sub>CC</sub> and V<sub>SS</sub> pins. Every 80C186EB-based circuit board should include separate power (V<sub>CC</sub>) and ground (V<sub>SS</sub>) planes. Every V<sub>CC</sub> pin must be connected to the power plane, and every V<sub>SS</sub> pin must be connected to the ground plane. Pins identified as "NC" must not be connected in the system. Liberal decoupling capacitance should be placed near the processor. The processor can cause transient power surges when its output buffers transition, particularly when connected to large capacitive loads.

NOTICE: This data sheet contains preliminary information on new products in production. It is valid for the devices indicated in the revision history. The specifications are subject to change without notice.

*\*WARNING: Stressing the device beyond the "Absolute Maximum Ratings" may cause permanent damage. These are stress ratings only. Operation beyond the "Operating Conditions" is not recommended and extended exposure beyond the "Operating Conditions" may affect device reliability.*

Low inductance capacitors and interconnects are recommended for best high frequency electrical performance. Inductance is reduced by placing the decoupling capacitors as close as possible to the processor V<sub>CC</sub> and V<sub>SS</sub> package pins.

Always connect any unused input to an appropriate signal level. In particular, unused interrupt inputs (INT0:4) should be connected to V<sub>CC</sub> through a pull-up resistor (in the range of 50 KΩ). **Leave any unused output pin or any NC pin unconnected.**

**DC SPECIFICATIONS (80C186EB/80C188EB)**

Symbol	Parameter	Min	Max	Units	Notes
$V_{CC}$	Supply Voltage	4.5	5.5	V	
$V_{IL}$	Input Low Voltage	-0.5	$0.3 V_{CC}$	V	
$V_{IH}$	Input High Voltage	$0.7 V_{CC}$	$V_{CC} + 0.5$	V	
$V_{OL}$	Output Low Voltage		0.45	V	$I_{OL} = 3 \text{ mA (Min)}$
$V_{OH}$	Output High Voltage	$V_{CC} - 0.5$		V	$I_{OH} = -2 \text{ mA (Min)}$
$V_{HYR}$	Input Hysteresis on $\overline{\text{RESIN}}$	0.50		V	
$I_{LH1}$	Input Leakage Current for Pins: AD15:0 (AD7:0), READY, HOLD, $\overline{\text{RESIN}}$ , CLKIN, TEST, NMI, INT4:0, T0IN, T1IN, RXD0, BCLK0, CTS0, RXD1, BCLK1, CTS1, P2.6, P2.7		$\pm 15$	$\mu\text{A}$	$0\text{V} \leq V_{IN} \leq V_{CC}$
$I_{LI2}$	Input Leakage Current for Pins: ERROR, PEREQ	$\pm 0.275$	$\pm 7$	mA	$0\text{V} \leq V_{IN} < V_{CC}$
$I_{LI3}$	Input Leakage Current for Pins: A19/ $\overline{\text{ONCE}}$ , A18:16, LOCK	-0.275	-5.0	mA	$V_{IN} = 0.7 V_{CC}$ (Note 1)
$I_{LO}$	Output Leakage Current		$\pm 15$	$\mu\text{A}$	$0.45 \leq V_{OUT} \leq V_{CC}$ (Note 2)
$I_{CC}$	Supply Current Cold (RESET) 80C186EB25		115	mA	(Notes 3, 7)
	80C186EB20		108	mA	(Note 3)
	80C186EB13		73	mA	(Note 3)
$I_{ID}$	Supply Current Idle 80C186EB25		91	mA	(Notes 4, 7)
	80C186EB20		76	mA	(Note 4)
	80C186EB13		48	mA	(Note 4)
$I_{PD}$	Supply Current Powerdown 80C186EB25		100	$\mu\text{A}$	(Notes 5, 7)
	80C186EB20		100	$\mu\text{A}$	(Note 5)
	80C186EB13		100	$\mu\text{A}$	(Note 5)
$C_{IN}$	Input Pin Capacitance	0	15	pF	$T_F = 1 \text{ MHz}$
$C_{OUT}$	Output Pin Capacitance	0	15	pF	$T_F = 1 \text{ MHz}$ (Note 6)

**NOTES:**

1. These pins have an internal pull-up device that is active while  $\overline{\text{RESIN}}$  is low and ONCE Mode is not active. Sourcing more current than specified (on any of these pins) may invoke a factory test mode.
2. Tested by outputs being floated by invoking ONCE Mode or by asserting HOLD.
3. Measured with the device in RESET and at worst case frequency,  $V_{CC}$ , and temperature with **ALL** outputs loaded as specified in AC Test Conditions, and all floating outputs driven to  $V_{CC}$  or GND.
4. Measured with the device in HALT (IDLE Mode active) and at worst case frequency,  $V_{CC}$ , and temperature with **ALL** outputs loaded as specified in AC Test Conditions, and all floating outputs driven to  $V_{CC}$  or GND.
5. Measured with the device in HALT (Powerdown Mode active) and at worst case frequency,  $V_{CC}$ , and temperature with **ALL** outputs loaded as specified in AC Test Conditions, and all floating outputs driven to  $V_{CC}$  or GND.
6. Output Capacitance is the capacitive load of a floating output pin.
7. Operating temperature for 25 MHz is  $0^\circ\text{C}$  to  $70^\circ\text{C}$ ,  $V_{CC} = 5.0 \pm 10\%$ .



**DC SPECIFICATIONS (80L186EB16)** (operating temperature, 0°C to 70°C)

Symbol	Parameter	Min	Max	Units	Notes
V <sub>CC</sub>	Supply Voltage	3.0	5.5	V	
V <sub>IL</sub>	Input Low Voltage	-0.5	0.3 V <sub>CC</sub>	V	
V <sub>IH</sub>	Input High Voltage	0.7 V <sub>CC</sub>	V <sub>CC</sub> + 0.5	V	
V <sub>OL</sub>	Output Low Voltage		0.45	V	I <sub>OL</sub> = 1.6 mA (Min) (Note 1)
V <sub>OH</sub>	Output High Voltage	V <sub>CC</sub> - 0.5		V	I <sub>OH</sub> = -1 mA (Min) (Note 1)
V <sub>HYSR</sub>	Input Hysteresis on $\overline{\text{RESIN}}$	0.50		V	
I <sub>LI1</sub>	Input Leakage Current for pins: AD15:0 (AD7:0), READY, HOLD, $\overline{\text{RESIN}}$ , CLKIN, $\overline{\text{TEST}}$ , NMI, INT4:0, T0IN, T1IN, RXD0, $\overline{\text{BCLK0}}$ , CTS0, RXD1, $\overline{\text{BCLK1}}$ , CTS1, SINT1, P2.6, P2.7		± 15	μA	0V ≤ V <sub>IN</sub> ≤ V <sub>CC</sub>
I <sub>LI2</sub>	Input Leakage Current for Pins: A19/ $\overline{\text{ONCE}}$ , A18:16, $\overline{\text{LOCK}}$	-0.275	-2	mA	V <sub>IN</sub> = 0.7 V <sub>CC</sub> (Note 2)
I <sub>LO</sub>	Output Leakage Current		± 15	μA	0.45 ≤ V <sub>OUT</sub> ≤ V <sub>CC</sub> (Note 3)
I <sub>CC3</sub>	Supply Current (RESET, 3.3V) 80L186EB16		54	mA	(Note 4)
I <sub>ID3</sub>	Supply Current Idle (3.3V) 80L186EB16		38	mA	(Note 5)
I <sub>PD3</sub>	Supply Current Powerdown (3.3V) 80L186EB16		40	μA	(Note 6)
C <sub>IN</sub>	Input Pin Capacitance	0	15	pF	T <sub>F</sub> = 1 MHz
C <sub>OUT</sub>	Output Pin Capacitance	0	15	pF	T <sub>F</sub> = 1 MHz (Note 7)

**NOTES:**

- I<sub>OL</sub> and I<sub>OH</sub> measured at V<sub>CC</sub> = 3.0V.
- These pins have an internal pull-up device that is active while  $\overline{\text{RESIN}}$  is low and ONCE Mode is not active. Sourcing more current than specified (on any of these pins) may invoke a factory test mode.
- Tested by outputs being floated by invoking ONCE Mode or by asserting HOLD.
- Measured with the device in RESET and at worst case frequency, V<sub>CC</sub>, and temperature with **ALL** outputs loaded as specified in AC Test Conditions, and all floating outputs driven to V<sub>CC</sub> or GND.
- Measured with the device in HALT (IDLE Mode active) and at worst case frequency, V<sub>CC</sub>, and temperature with **ALL** outputs loaded as specified in AC Test Conditions, and all floating outputs driven to V<sub>CC</sub> or GND.
- Measured with the device in HALT (Powerdown Mode active) and at worst case frequency, V<sub>CC</sub>, and temperature with **ALL** outputs loaded as specified in AC Test Conditions, and all floating outputs driven to V<sub>CC</sub> or GND.
- Output Capacitance is the capacitive load of a floating output pin.

## DC SPECIFICATIONS (80L186EB13/80L188EB13, 80L186EB8/80L188EB8)

Symbol	Parameter	Min	Max	Units	Notes
V <sub>CC</sub>	Supply Voltage	2.7	5.5	V	
V <sub>IL</sub>	Input Low Voltage	-0.5	0.3 V <sub>CC</sub>	V	
V <sub>IH</sub>	Input High Voltage	0.7 V <sub>CC</sub>	V <sub>CC</sub> + 0.5	V	
V <sub>OL</sub>	Output Low Voltage		0.45	V	I <sub>OL</sub> = 1.6 mA (Min) (Note 1)
V <sub>OH</sub>	Output High Voltage	V <sub>CC</sub> - 0.5		V	I <sub>OH</sub> = -1 mA (Min) (Note 1)
V <sub>HYSR</sub>	Input Hysteresis on $\overline{\text{RESIN}}$	0.50		V	
I <sub>LI1</sub>	Input Leakage Current for pins: AD15:0 (AD7:0), READY, HOLD, $\overline{\text{RESIN}}$ , CLKIN, $\overline{\text{TEST}}$ , NMI, INT4:0, T0IN, T1IN, RXD0, $\overline{\text{BCLK0}}$ , CTS0, RXD1, $\overline{\text{BCLK1}}$ , CTS1, SINT1, P2.6, P2.7		± 15	μA	0V ≤ V <sub>IN</sub> ≤ V <sub>CC</sub>
I <sub>LI2</sub>	Input Leakage Current for Pins: A19/ $\overline{\text{ONCE}}$ , A18:16, $\overline{\text{LOCK}}$	-0.275	-2	mA	V <sub>IN</sub> = 0.7 V <sub>CC</sub> (Note 2)
I <sub>LO</sub>	Output Leakage Current		± 15	μA	0.45 ≤ V <sub>OUT</sub> ≤ V <sub>CC</sub> (Note 3)
I <sub>CC5</sub>	Supply Current (RESET, 5.5V) 80L186EB13 80L186EB8		73 45	mA mA	(Note 4) (Note 4)
I <sub>CC3</sub>	Supply Current (RESET, 2.7V) 80L186EB13 80L186EB8		36 22	mA mA	(Note 4) (Note 4)
I <sub>ID5</sub>	Supply Current Idle (5.5V) 80L186EB13 80L186EB8		48 31	mA mA	(Note 5) (Note 5)
I <sub>ID3</sub>	Supply Current Idle (2.7V) 80L186EB13 80L186EB8		24 15	mA mA	(Note 5) (Note 5)
I <sub>PD5</sub>	Supply Current Powerdown (5.5V) 80L186EB13 80L186EB8		100 100	μA μA	(Note 6) (Note 6)
I <sub>PD3</sub>	Supply Current Powerdown (2.7V) 80L186EB13 80L186EB8		30 30	μA μA	(Note 6) (Note 6)
C <sub>IN</sub>	Input Pin Capacitance	0	15	pF	T <sub>F</sub> = 1 MHz
C <sub>OUT</sub>	Output Pin Capacitance	0	15	pF	T <sub>F</sub> = 1 MHz (Note 7)

## NOTES:

- I<sub>OL</sub> and I<sub>OH</sub> measured at V<sub>CC</sub> = 2.7V.
- These pins have an internal pull-up device that is active while  $\overline{\text{RESIN}}$  is low and ONCE Mode is not active. Sourcing more current than specified (on any of these pins) may invoke a factory test mode.
- Tested by outputs being floated by invoking ONCE Mode or by asserting HOLD.
- Measured with the device in RESET and at worst case frequency, V<sub>CC</sub>, and temperature with **ALL** outputs loaded as specified in AC Test Conditions, and all floating outputs driven to V<sub>CC</sub> or GND.
- Measured with the device in HALT (IDLE Mode active) and at worst case frequency, V<sub>CC</sub>, and temperature with **ALL** outputs loaded as specified in AC Test Conditions, and all floating outputs driven to V<sub>CC</sub> or GND.
- Measured with the device in HALT (Powerdown Mode active) and at worst case frequency, V<sub>CC</sub>, and temperature with **ALL** outputs loaded as specified in AC Test Conditions, and all floating outputs driven to V<sub>CC</sub> or GND.
- Output Capacitance is the capacitive load of a floating output pin.



**I<sub>CC</sub> VERSUS FREQUENCY AND VOLTAGE**

The current (I<sub>CC</sub>) consumption of the processor is essentially composed of two components; I<sub>PD</sub> and I<sub>CCS</sub>.

I<sub>PD</sub> is the **quiescent** current that represents internal device leakage, and is measured with all inputs or floating outputs at GND or V<sub>CC</sub> (no clock applied to the device). I<sub>PD</sub> is equal to the Powerdown current and is typically less than 50 μA.

I<sub>CCS</sub> is the **switching** current used to charge and discharge parasitic device capacitance when changing logic levels. Since I<sub>CCS</sub> is typically much greater than I<sub>PD</sub>, I<sub>PD</sub> can often be ignored when calculating I<sub>CC</sub>.

I<sub>CCS</sub> is related to the voltage and frequency at which the device is operating. It is given by the formula:

$$\text{Power} = V \times I = V^2 \times C_{\text{DEV}} \times f$$

$$\therefore I = I_{\text{CC}} = I_{\text{CCS}} = V \times C_{\text{DEV}} \times f$$

Where: V = Device operating voltage (V<sub>CC</sub>)

C<sub>DEV</sub> = Device capacitance

f = Device operating frequency

I<sub>CCS</sub> = I<sub>CC</sub> = Device current

Measuring C<sub>DEV</sub> on a device like the 80C186EB would be difficult. Instead, C<sub>DEV</sub> is calculated using the above formula by measuring I<sub>CC</sub> at a known V<sub>CC</sub> and frequency (see Table 11). Using this C<sub>DEV</sub> value, I<sub>CC</sub> can be calculated at any voltage and frequency within the specified operating range.

EXAMPLE: Calculate the typical I<sub>CC</sub> when operating at 10 MHz, 4.8V.

$$I_{\text{CC}} = I_{\text{CCS}} = 4.8 \times 0.583 \times 10 \approx 28 \text{ mA}$$

**PDTMR PIN DELAY CALCULATION**

The PDTMR pin provides a delay between the assertion of NMI and the enabling of the internal clocks when exiting Powerdown. A delay is required only when using the on-chip oscillator to allow the crystal or resonator circuit time to stabilize.

**NOTE:**

The PDTMR pin function does not apply when RESIN is asserted (i.e., a device reset during Powerdown is similar to a cold reset and RESIN must remain active until after the oscillator has stabilized).

To calculate the value of capacitor required to provide a desired delay, use the equation:

$$440 \times t = C_{\text{PD}} \quad (5V, 25^\circ\text{C})$$

Where: t = desired delay in **seconds**

C<sub>PD</sub> = capacitive load on PDTMR in **microfarads**

EXAMPLE: To get a delay of 300 μs, a capacitor value of C<sub>PD</sub> = 440 × (300 × 10<sup>-6</sup>) = 0.132 μF is required. Round up to standard (available) capacitive values.

**NOTE:**

The above equation applies to delay times greater than 10 μs and will compute the **TYPICAL** capacitance needed to achieve the desired delay. A delay variance of +50% or -25% can occur due to temperature, voltage, and device process extremes. In general, higher V<sub>CC</sub> and/or lower temperature will decrease delay time, while lower V<sub>CC</sub> and/or higher temperature will increase delay time.

**Table 11. Device Capacitance (C<sub>DEV</sub>) Values**

Parameter	Typ	Max	Units	Notes
C <sub>DEV</sub> (Device in Reset)	0.583	1.02	mA/V*MHz	1, 2
C <sub>DEV</sub> (Device in Idle)	0.408	0.682	mA/V*MHz	1, 2

1. Max C<sub>DEV</sub> is calculated at -40°C, all floating outputs driven to V<sub>CC</sub> or GND, and all outputs loaded to 50 pF (including CLKOUT and OSCOUT).  
 2. Typical C<sub>DEV</sub> is calculated at 25°C with all outputs loaded to 50 pF except CLKOUT and OSCOUT, which are not loaded.

## AC SPECIFICATIONS

## AC Characteristics—80C186EB25

Symbol	Parameter	25 MHz		Units	Notes
		Min	Max		
<b>INPUT CLOCK</b>					
$T_F$	CLKIN Frequency	0	50	MHz	1
$T_C$	CLKIN Period	20	$\infty$	ns	1
$T_{CH}$	CLKIN High Time	8	$\infty$	ns	1, 2
$T_{CL}$	CLKIN Low Time	8	$\infty$	ns	1, 2
$T_{CR}$	CLKIN Rise Time	1	7	ns	1, 3
$T_{CF}$	CLKIN Fall Time	1	7	ns	1, 3
<b>OUTPUT CLOCK</b>					
$T_{CD}$	CLKIN to CLKOUT Delay	0	16	ns	1, 4
$T$	CLKOUT Period		$2 * T_C$	ns	1
$T_{PH}$	CLKOUT High Time	$(T/2) - 5$	$(T/2) + 5$	ns	1
$T_{PL}$	CLKOUT Low Time	$(T/2) - 5$	$(T/2) + 5$	ns	1
$T_{PR}$	CLKOUT Rise Time	1	6	ns	1, 5
$T_{PF}$	CLKOUT Fall Time	1	6	ns	1, 5
<b>OUTPUT DELAYS</b>					
$T_{CHOV1}$	$\overline{ALE}$ , $\overline{S2:0}$ , $\overline{DEN}$ , $\overline{DT/R}$ , $\overline{BHE}$ ( $\overline{RFSH}$ ), $\overline{LOCK}$ , A19:16	3	17	ns	1, 4, 6, 7
$T_{CHOV2}$	$\overline{GCS0:7}$ , $\overline{LCS}$ , $\overline{UCS}$ , $\overline{NCS}$ , $\overline{RD}$ , $\overline{WR}$	3	20	ns	1, 4, 6, 8
$T_{CLOV1}$	$\overline{BHE}$ ( $\overline{RFSH}$ ), $\overline{DEN}$ , $\overline{LOCK}$ , RESOUT, HLDA, T0OUT, T1OUT, A19:16	3	17	ns	1, 4, 6
$T_{CLOV2}$	$\overline{RD}$ , $\overline{WR}$ , $\overline{GCS7:0}$ , $\overline{LCS}$ , $\overline{UCS}$ , AD15:0 (AD7:0, A15:8), $\overline{NCS}$ , INTA1:0, $\overline{S2:0}$	3	20	ns	1, 4, 6
$T_{CHOF}$	$\overline{RD}$ , $\overline{WR}$ , $\overline{BHE}$ ( $\overline{RFSH}$ ), $\overline{DT/R}$ , $\overline{LOCK}$ , $\overline{S2:0}$ , A19:16	0	20	ns	1
$T_{CLOF}$	$\overline{DEN}$ , AD15:0 (AD7:0, A15:8)	0	20	ns	1



## AC SPECIFICATIONS

## AC Characteristics—80C186EB25 (Continued)

Symbol	Parameter	25 MHz		Units	Notes
		Min	Max		
<b>SYNCHRONOUS INPUTS</b>					
T <sub>CHIS</sub>	$\overline{\text{TEST}}$ , NMI, INT4:0, BCLK1:0, T1:0IN, READY, $\overline{\text{CTS1:0}}$ , P2.6, P2.7	10		ns	1, 9
T <sub>CHIH</sub>	$\overline{\text{TEST}}$ , NMI, INT4:0, BCLK1:0, T1:0IN, READY, $\overline{\text{CTS1:0}}$	3		ns	1, 9
T <sub>CLIS</sub>	AD15:0 (AD7:0), READY	10		ns	1, 10
T <sub>CLIH</sub>	READY, AD15:0 (AD7:0)	3		ns	1, 10
T <sub>CLIS</sub>	HOLD, PEREQ, $\overline{\text{ERROR}}$	10		ns	1, 9
T <sub>CLIH</sub>	HOLD, PEREQ, $\overline{\text{ERROR}}$	3		ns	1, 9

## NOTES:

1. See **AC Timing Waveforms**, for waveforms and definition.
2. Measure at V<sub>IH</sub> for high time, V<sub>IL</sub> for low time.
3. Only required to guarantee I<sub>CC</sub>. Maximum limits are bounded by T<sub>C</sub>, T<sub>CH</sub> and T<sub>CL</sub>.
4. Specified for a 50 pF load, see Figure 13 for capacitive derating information.
5. Specified for a 50 pF load, see Figure 14 for rise and fall times outside 50 pF.
6. See Figure 14 for rise and fall times.
7. T<sub>CHOV1</sub> applies to  $\overline{\text{BHE}}$  ( $\overline{\text{RFSH}}$ ),  $\overline{\text{LOCK}}$  and A19:16 only after a HOLD release.
8. T<sub>CHOV2</sub> applies to  $\overline{\text{RD}}$  and  $\overline{\text{WR}}$  only after a HOLD release.
9. Setup and Hold are required to guarantee recognition.
10. Setup and Hold are required for proper operation.

## AC SPECIFICATIONS

## AC Characteristics—80C186EB20/80C186EB13

Symbol	Parameter	20 MHz		13 MHz		Units	Notes
		Min	Max	Min	Max		
<b>INPUT CLOCK</b>							
$T_F$	CLKIN Frequency	0	40	0	26	MHz	1
$T_C$	CLKIN Period	25	$\infty$	38.5	$\infty$	ns	1
$T_{CH}$	CLKIN High Time	10	$\infty$	12	$\infty$	ns	1, 2
$T_{CL}$	CLKIN Low Time	10	$\infty$	12	$\infty$	ns	1, 2
$T_{CR}$	CLKIN Rise Time	1	8	1	8	ns	1, 3
$T_{CF}$	CLKIN Fall Time	1	8	1	8	ns	1, 3
<b>OUTPUT CLOCK</b>							
$T_{CD}$	CLKIN to CLKOUT Delay	0	17	0	23	ns	1, 4
$T$	CLKOUT Period		$2 * T_C$		$2 * T_C$	ns	1
$T_{PH}$	CLKOUT High Time	$(T/2) - 5$	$(T/2) + 5$	$(T/2) - 5$	$(T/2) + 5$	ns	1
$T_{PL}$	CLKOUT Low Time	$(T/2) - 5$	$(T/2) + 5$	$(T/2) - 5$	$(T/2) + 5$	ns	1
$T_{PR}$	CLKOUT Rise Time	1	6	1	6	ns	1, 5
$T_{PF}$	CLKOUT Fall Time	1	6	1	6	ns	1, 5
<b>OUTPUT DELAYS</b>							
$T_{CHOV1}$	$\overline{ALE}$ , $\overline{S2:0}$ , $\overline{DEN}$ , $\overline{DT/R}$ , $\overline{BHE}$ (RFSH), $\overline{LOCK}$ , A19:16	3	22	3	25	ns	1, 4, 6, 7
$T_{CHOV2}$	$\overline{GCS0:7}$ , $\overline{LCS}$ , $\overline{UCS}$ , $\overline{NCS}$ , $\overline{RD}$ , $\overline{WR}$	3	27	3	30	ns	1, 4, 6, 8
$T_{CLOV1}$	$\overline{BHE}$ (RFSH), $\overline{DEN}$ , $\overline{LOCK}$ , $\overline{RESOUT}$ , $\overline{HLDA}$ , $\overline{T0OUT}$ , $\overline{T1OUT}$ , A19:16	3	22	3	25	ns	1, 4, 6
$T_{CLOV2}$	$\overline{RD}$ , $\overline{WR}$ , $\overline{GCS7:0}$ , $\overline{LCS}$ , $\overline{UCS}$ , AD15:0 (AD7:0, A15:8), $\overline{NCS}$ , $\overline{INTA1:0}$ , $\overline{S2:0}$	3	27	3	30	ns	1, 4, 6
$T_{CHOF}$	$\overline{RD}$ , $\overline{WR}$ , $\overline{BHE}$ (RFSH), $\overline{DT/R}$ , $\overline{LOCK}$ , $\overline{S2:0}$ , A19:16	0	25	0	25	ns	1
$T_{CLOF}$	$\overline{DEN}$ , AD15:0 (AD7:0, A15:8)	0	25	0	25	ns	1



**AC SPECIFICATIONS**

**AC Characteristics—80C186EB20/80C186EB13 (Continued)**

Symbol	Parameter	20 MHz		13 MHz		Units	Notes
		Min	Max	Min	Max		
<b>SYNCHRONOUS INPUTS</b>							
T <sub>CHIS</sub>	$\overline{\text{TEST}}$ , NMI, INT4:0, BCLK1:0, T1:0IN, READY, CTS1:0, P2.6, P2.7	10		10		ns	1, 9
T <sub>CHIH</sub>	$\overline{\text{TEST}}$ , NMI, INT4:0, BCLK1:0, T1:0IN, READY, CTS1:0	3		3		ns	1, 9
T <sub>CLIS</sub>	AD15:0 (AD7:0), READY	10		10		ns	1, 10
T <sub>CLIH</sub>	READY, AD15:0 (AD7:0)	3		3		ns	1, 10
T <sub>CLIS</sub>	HOLD, PEREQ, $\overline{\text{ERROR}}$	10		10		ns	1, 9
T <sub>CLIH</sub>	HOLD, PEREQ, $\overline{\text{ERROR}}$	3		3		ns	1, 9

**NOTES:**

1. See **AC Timing Waveforms**, for waveforms and definition.
2. Measure at V<sub>IH</sub> for high time, V<sub>IL</sub> for low time.
3. Only required to guarantee I<sub>CC</sub>. Maximum limits are bounded by T<sub>C</sub>, T<sub>CH</sub> and T<sub>CL</sub>.
4. Specified for a 50 pF load, see Figure 13 for capacitive derating information.
5. Specified for a 50 pF load, see Figure 14 for rise and fall times outside 50 pF.
6. See Figure 14 for rise and fall times.
7. T<sub>CHOV1</sub> applies to  $\overline{\text{BHE}}$  (RFSH),  $\overline{\text{LOCK}}$  and A19:16 only after a HOLD release.
8. T<sub>CHOV2</sub> applies to  $\overline{\text{RD}}$  and  $\overline{\text{WR}}$  only after a HOLD release.
9. Setup and Hold are required to guarantee recognition.
10. Setup and Hold are required for proper operation.

## AC SPECIFICATIONS

## AC Characteristics—80L186EB16

Symbol	Parameter	16 MHz		Units	Notes
		Min	Max		
<b>INPUT CLOCK</b>					
$T_F$	CLKIN Frequency	0	32	MHz	1
$T_C$	CLKIN Period	31.25	$\infty$	ns	1
$T_{CH}$	CLKIN High Time	13	$\infty$	ns	1, 2
$T_{CL}$	CLKIN Low Time	13	$\infty$	ns	1, 2
$T_{CR}$	CLKIN Rise Time	1	8	ns	1, 3
$T_{CF}$	CLKIN Fall Time	1	8	ns	1, 3
<b>OUTPUT CLOCK</b>					
$T_{CD}$	CLKIN to CLKOUT Delay	0	30	ns	1, 4
$T$	CLKOUT Period		$2 * T_C$	ns	1
$T_{PH}$	CLKOUT High Time	$(T/2) - 5$	$(T/2) + 5$	ns	1
$T_{PL}$	CLKOUT Low Time	$(T/2) - 5$	$(T/2) + 5$	ns	1
$T_{PR}$	CLKOUT Rise Time	1	9	ns	1, 5
$T_{PF}$	CLKOUT Fall Time	1	9	ns	1, 5
<b>OUTPUT DELAYS</b>					
$T_{CHOV1}$	$\overline{DT}/\overline{R}$ , $\overline{LOCK}$ , A19:16, $R_{FSH}$	3	22	ns	1, 4, 6, 7
$T_{CHOV2}$	$\overline{GCS0:7}$ , $\overline{LCS}$ , $\overline{UCS}$ , $\overline{NCS}$ , $\overline{RD}$ , $\overline{WR}$	3	27	ns	1, 4, 6, 8
$T_{CHOV3}$	$\overline{BHE}$ , $\overline{DEN}$	3	25	ns	1, 4
$T_{CHOV4}$	ALE	3	30	ns	1, 4
$T_{CHOV5}$	$\overline{S2:0}$	3	33	ns	1, 4
$T_{CLOV1}$	$\overline{LOCK}$ , $\overline{RESOUT}$ , $\overline{HLDA}$ , $T0OUT$ , $T1OUT$ , A19:16	3	22	ns	1, 4, 6
$T_{CLOV2}$	$\overline{RD}$ , $\overline{WR}$ , $\overline{GCS7:0}$ , $\overline{LCS}$ , $\overline{UCS}$ , $\overline{NCS}$ , $\overline{INTA1:0}$ , AD15:0 (AD7:0, A15:8)	3	27	ns	1, 4, 6
$T_{CHOF}$	$\overline{RD}$ , $\overline{WR}$ , $\overline{BHE}$ ( $R_{FSH}$ ), $\overline{DT}/\overline{R}$ , $\overline{LOCK}$ , $\overline{S2:0}$ , A19:16	0	25	ns	1
$T_{CLOF}$	$\overline{DEN}$ , AD15:0 (AD7:0, A15:8)	0	25	ns	1
$T_{CLOV3}$	$\overline{BHE}$ , $\overline{DEN}$	3	25	ns	1, 4, 6
$T_{CLOV5}$	$\overline{S2:0}$	3	33	ns	1, 4, 6





## AC SPECIFICATIONS

## AC Characteristics—80L186EB16 (Continued)

Symbol	Parameter	16 MHz		Units	Notes
		Min	Max		
<b>SYNCHRONOUS INPUTS</b>					
T <sub>CHIS</sub>	$\overline{\text{TEST}}$ , NMI, INT4:0, BCLK1:0, T1:0IN, READY, $\overline{\text{CTS1:0}}$ , P2.6, P2.7	15		ns	1, 9
T <sub>CHIH</sub>	$\overline{\text{TEST}}$ , NMI, INT4:0, T1:0IN, BCLK1:0, READY, $\overline{\text{CTS1:0}}$	3		ns	1, 9
T <sub>CLIS</sub>	AD15:0 (AD7:0), READY	15		ns	1, 10
T <sub>CLIH</sub>	READY, AD15:0 (AD7:0)	3		ns	1, 10
T <sub>CLIS</sub>	HOLD	15		ns	1, 9
T <sub>CLIH</sub>	HOLD	3		ns	1, 9

## NOTES:

1. See **AC Timing Waveforms**, for waveforms and definition.
2. Measure at V<sub>IH</sub> for high time, V<sub>IL</sub> for low time.
3. Only required to guarantee I<sub>CC</sub>. Maximum limits are bounded by T<sub>C</sub>, T<sub>CH</sub> and T<sub>CL</sub>.
4. Specified for a 50 pF load, see Figure 13 for capacitive derating information.
5. Specified for a 50 pF load, see Figure 14 for rise and fall times outside 50 pF.
6. See Figure 14 for rise and fall times.
7. T<sub>CHOV1</sub> applies to  $\overline{\text{BHE}}$  ( $\overline{\text{RFSH}}$ ),  $\overline{\text{LOCK}}$  and A19:16 only after a HOLD release.
8. T<sub>CHOV2</sub> applies to  $\overline{\text{RD}}$  and  $\overline{\text{WR}}$  only after a HOLD release.
9. Setup and Hold are required to guarantee recognition.
10. Setup and Hold are required for proper operation.

## AC SPECIFICATIONS

## AC Characteristics—80L186EB13/80L186EB8

Symbol	Parameter	13 MHz		8 MHz		Units	Notes
		Min	Max	Min	Max		
<b>INPUT CLOCK</b>							
$T_r$	CLKIN Frequency	0	26	0	16	MHz	1
$T_C$	CLKIN Period	38.5	$\infty$	62.5	$\infty$	ns	1
$T_{CH}$	CLKIN High Time	15	$\infty$	15	$\infty$	ns	1, 2
$T_{CL}$	CLKIN Low Time	15	$\infty$	15	$\infty$	ns	1, 2
$T_{CR}$	CLKIN Rise Time	1	8	1	8	ns	1, 3
$T_{CF}$	CLKIN Fall Time	1	8	1	8	ns	1, 3
<b>OUTPUT CLOCK</b>							
$T_{CD}$	CLKIN to CLKOUT Delay	0	10	0	50	ns	1, 4
$T_C$	CLKOUT Period		$2 \cdot T_C$		$2 \cdot T_C$	ns	1
$T_{PH}$	CLKOUT High Time	$(T/2) - 5$	$(T/2) + 5$	$(T/2) - 5$	$(T/2) + 5$	ns	1
$T_{PL}$	CLKOUT Low Time	$(T/2) - 5$	$(T/2) + 5$	$(T/2) - 5$	$(T/2) + 5$	ns	1
$T_{PR}$	CLKOUT Rise Time	1	10	1	15	ns	1, 5
$T_{PF}$	CLKOUT Fall Time	1	10	1	15	ns	1, 5
<b>OUTPUT DELAYS</b>							
$T_{CHOV1}$	ALE, $\overline{S2:0}$ , $\overline{DEN}$ , $\overline{DT/\overline{R}}$ , $\overline{BHE}$ (RFSH), $\overline{LOCK}$ , A19:16	3	25	3	30	ns	1, 4, 6, 7
$T_{CHOV2}$	$\overline{GCS0:7}$ , $\overline{LCS}$ , $\overline{UCS}$ , $\overline{NCS}$ , $\overline{RD}$ , $\overline{WR}$	3	30	3	35	ns	1, 4, 6, 8
$T_{CLOV1}$	$\overline{BHE}$ (RFSH), $\overline{DEN}$ , $\overline{LOCK}$ , $\overline{RESOUT}$ , $\overline{HLDA}$ , $\overline{T0OUT}$ , $\overline{T1OUT}$ , A19:16	3	25	3	30	ns	1, 4, 6
$T_{CLOV2}$	$\overline{S2:0}$ , $\overline{RD}$ , $\overline{WR}$ , $\overline{GCS7:0}$ , $\overline{LCS}$ , $\overline{UCS}$ , $\overline{NCS}$ , $\overline{INTA1:0}$ , AD15:0 (AD7:0, A15:8)	3	30	3	35	ns	1, 4, 6
$T_{CHOF}$	$\overline{RD}$ , $\overline{WR}$ , $\overline{BHE}$ (RFSH), $\overline{DT/\overline{R}}$ , $\overline{LOCK}$ , $\overline{S2:0}$ , A19:16	0	30	0	30	ns	1
$T_{CLOF}$	$\overline{DEN}$ , AD15:0 (AD7:0, A15:8)	0	30	0	35	ns	1



## AC SPECIFICATIONS

## AC Characteristics—80L186EB13/80L186EB8 (Continued)

Symbol	Parameter	13 MHz		8 MHz		Units	Notes
		Min	Max	Min	Max		
<b>SYNCHRONOUS INPUTS</b>							
$T_{CHIS}$	$\overline{TEST}$ , NMI, INT4:0, BCLK1:0, T1:0IN, READY, $\overline{CTS1:0}$ , P2.6, P2.7	20		25		ns	1, 9
$T_{CHIH}$	$\overline{TEST}$ , NMI, INT4:0, T1:0IN, BCLK1:0, READY, $\overline{CTS1:0}$	3		3		ns	1, 9
$T_{CLIS}$	AD15:0 (AD7:0), READY	20		25		ns	1, 10
$T_{CLIH}$	READY, AD15:0 (AD7:0)	3		3		ns	1, 10
$T_{CLIS}$	HOLD	20		25		ns	1, 9
$T_{CLIH}$	HOLD	3		3		ns	1, 9

**NOTES:**

1. See **AC Timing Waveforms**, for waveforms and definition.
2. Measured at  $V_{IH}$  for high time,  $V_{IL}$  for low time.
3. Only required to guarantee  $I_{CC}$ . Maximum limits are bounded by  $T_C$ ,  $T_{CH}$  and  $T_{CL}$ .
4. Specified for a 50 pF load, see Figure 13 for capacitive derating information.
5. Specified for a 50 pF load, see Figure 14 for rise and fall times outside 50 pF.
6. See Figure 14 for rise and fall times.
7.  $T_{CHOV1}$  applies to  $\overline{BHE}$  (RFSH),  $\overline{LOCK}$  and A19:16 only after a HOLD release.
8.  $T_{CHOV2}$  applies to  $\overline{RD}$  and  $\overline{WR}$  only after a HOLD release.
9. Setup and Hold are required to guarantee recognition.
10. Setup and Hold are required for proper operation.

## AC SPECIFICATIONS (Continued)

## Relative Timings (80C186EB25, 20, 13/80L186EB16, 13, 8)

Symbol	Parameter	Min	Max	Units	Notes
<b>RELATIVE TIMINGS</b>					
$T_{LHLL}$	ALE Rising to ALE Falling	$T - 15$		ns	
$T_{AVLL}$	Address Valid to ALE Falling	$\frac{1}{2}T - 10$		ns	
$T_{PLLL}$	Chip Selects Valid to ALE Falling	$\frac{1}{2}T - 10$		ns	1
$T_{LLAX}$	Address Hold from ALE Falling	$\frac{1}{2}T - 10$		ns	
$T_{LLWL}$	ALE Falling to $\overline{WR}$ Falling	$\frac{1}{2}T - 15$		ns	1
$T_{LLRL}$	ALE Falling to $\overline{RD}$ Falling	$\frac{1}{2}T - 15$		ns	1
$T_{WHLH}$	$\overline{WR}$ Rising to ALE Rising	$\frac{1}{2}T - 10$		ns	1
$T_{AFRL}$	Address Float to $\overline{RD}$ Falling	0		ns	
$T_{RLRH}$	$\overline{RD}$ Falling to $\overline{RD}$ Rising	$(2^*T) - 5$		ns	2
$T_{WLWH}$	$\overline{WR}$ Falling to $\overline{WR}$ Rising	$(2^*T) - 5$		ns	2
$T_{RHAV}$	$\overline{RD}$ Rising to Address Active	$T - 15$		ns	
$T_{WHDX}$	Output Data Hold after $\overline{WR}$ Rising	$T - 15$		ns	
$T_{WHPH}$	$\overline{WR}$ Rising to Chip Select Rising	$\frac{1}{2}T - 10$		ns	1
$T_{RHPH}$	$\overline{RD}$ Rising to Chip Select Rising	$\frac{1}{2}T - 10$		ns	1
$T_{PHPL}$	$\overline{CS}$ Inactive to $\overline{CS}$ Active	$\frac{1}{2}T - 10$		ns	1
$T_{OVRH}$	$\overline{ONCE}$ Active to $\overline{RESIN}$ Rising	$T$		ns	3
$T_{RHOX}$	$\overline{ONCE}$ Hold from $\overline{RESIN}$ Rising	$T$		ns	3

**NOTES:**

1. Assumes equal loading on both pins.
2. Can be extended using wait states.
3. Not tested

**AC SPECIFICATIONS** (Continued)**Serial Port Mode 0 Timings** (80C186EB25, 20, 13/80L186EB16, 13, 8)

Symbol	Parameter	Min	Max	Unit	Notes
T <sub>XLXL</sub>	TXD Clock Period	T (n + 1)		ns	1, 2
T <sub>XLXH</sub>	TXD Clock Low to Clock High (n > 1)	2T - 35	2T + 35	ns	1
T <sub>XLXH</sub>	TXD Clock Low to Clock High (n = 1)	T - 35	T + 35	ns	1
T <sub>XHXL</sub>	TXD Clock High to Clock Low (n > 1)	(n - 1) T - 35	(n - 1) T + 35	ns	1, 2
T <sub>XHXL</sub>	TXD Clock High to Clock Low (n = 1)	T - 35	T + 35	ns	1
T <sub>QVXH</sub>	RXD Output Data Setup to TXD Clock High (n > 1)	(n - 1) T - 35		ns	1, 2
T <sub>QVXH</sub>	RXD Output Data Setup to TXD Clock High (n = 1)	T - 35		ns	1
T <sub>XHQX</sub>	RXD Output Data Hold after TXD Clock High (n > 1)	2T - 35		ns	1
T <sub>XHQX</sub>	RXD Output Data Hold after TXD Clock High (n = 1)	T - 35		ns	1
T <sub>XHQZ</sub>	RXD Output Data Float after Last TXD Clock High		T + 20	ns	1
T <sub>DVXH</sub>	RXD Input Data Setup to TXD Clock High	T + 20		ns	1
T <sub>XHDX</sub>	RXD Input Data Hold after TXD Clock High	0		ns	1

**NOTES:**

1. See Figure 12 for waveforms.
2. n is the value of the BxCMP register ignoring the ICLK Bit (i.e., ICLK = 0).

### AC TEST CONDITIONS

The AC specifications are tested with the 50 pF load shown in Figure 7. See the Derating Curves section to see how timings vary with load capacitance.

Specifications are measured at the  $V_{CC}/2$  crossing point, unless otherwise specified. See AC Timing Waveforms, for AC specification definitions, test pins, and illustrations.



**Figure 7. AC Test Load**

### AC TIMING WAVEFORMS



**Figure 8. Input and Output Clock Waveform**



Figure 9. Output Delay and Float Waveform



Figure 10. Input Setup and Hold

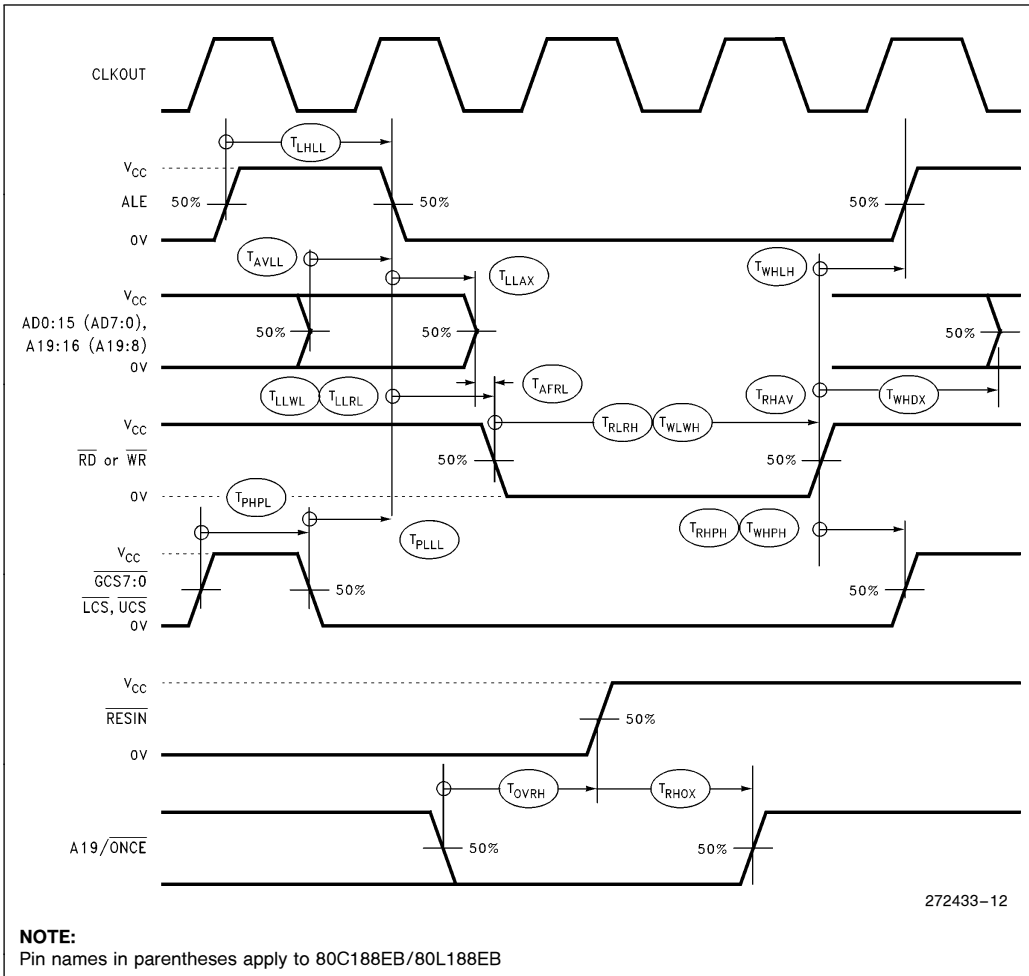

Figure 11. Relative Signal Waveform

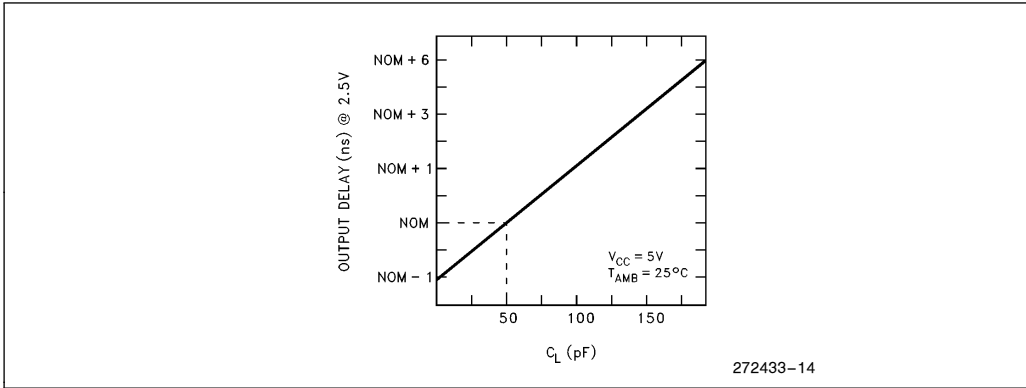

Figure 12. Serial Port Mode 0 Waveform



**DERATING CURVES**

**TYPICAL OUTPUT DELAY VARIATIONS VERSUS LOAD CAPACITANCE**



**Figure 13**

**TYPICAL RISE AND FALL VARIATIONS VERSUS LOAD CAPACITANCE**

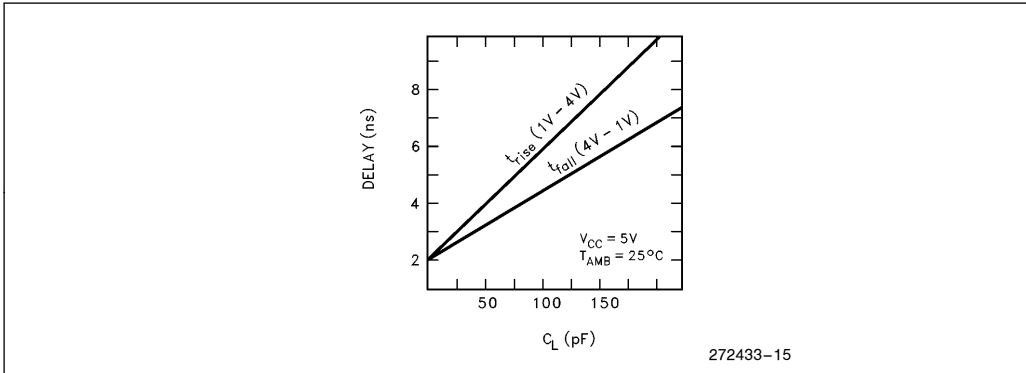

**Figure 14**

## RESET

The processor will perform a reset operation any time the  $\overline{\text{RESIN}}$  pin active. The  $\overline{\text{RESIN}}$  pin is actually synchronized before it is presented internally, which means that the clock must be operating before a reset can take effect. From a power-on state,  $\overline{\text{RESIN}}$  must be held active (low) in order to guarantee correct initialization of the processor. **Failure to provide  $\overline{\text{RESIN}}$  while the device is powering up will result in unspecified operation of the device.**

Figure 14 shows the correct reset sequence when first applying power to the processor. An external clock connected to CLKIN must not exceed the  $V_{CC}$  threshold being applied to the processor. This is normally not a problem if the clock driver is supplied with the same  $V_{CC}$  that supplies the processor. When attaching a crystal to the device,  $\overline{\text{RESIN}}$  must remain active until both  $V_{CC}$  and CLKOUT are stable (the length of time is application specific and depends on the startup characteristics of the crystal

circuit). The  $\overline{\text{RESIN}}$  pin is designed to operate correctly using an RC reset circuit, but the designer must ensure that the ramp time for  $V_{CC}$  is not so long that  $\overline{\text{RESIN}}$  is never really sampled at a logic low level when  $V_{CC}$  reaches minimum operating conditions.

Figure 16 shows the timing sequence when  $\overline{\text{RESIN}}$  is applied after  $V_{CC}$  is stable and the device has been operating. Note that a reset will terminate all activity and return the processor to a known operating state. Any bus operation that is in progress at the time  $\overline{\text{RESIN}}$  is asserted will terminate immediately (note that most control signals will be driven to their inactive state first before floating).

While  $\overline{\text{RESIN}}$  is active, bus signals  $\overline{\text{LOCK}}$ , A19/ $\overline{\text{ONCE}}$ , and A18:16 are configured as inputs and weakly held high by internal pullup transistors. Only 19/ $\overline{\text{ONCE}}$  can be overdriven to a low and is used to enable ONCE Mode. Forcing  $\overline{\text{LOCK}}$  or A18:16 low at any time while  $\overline{\text{RESIN}}$  is low is prohibited and will cause unspecified device operation.



Figure 15. Cold Reset Waveforms

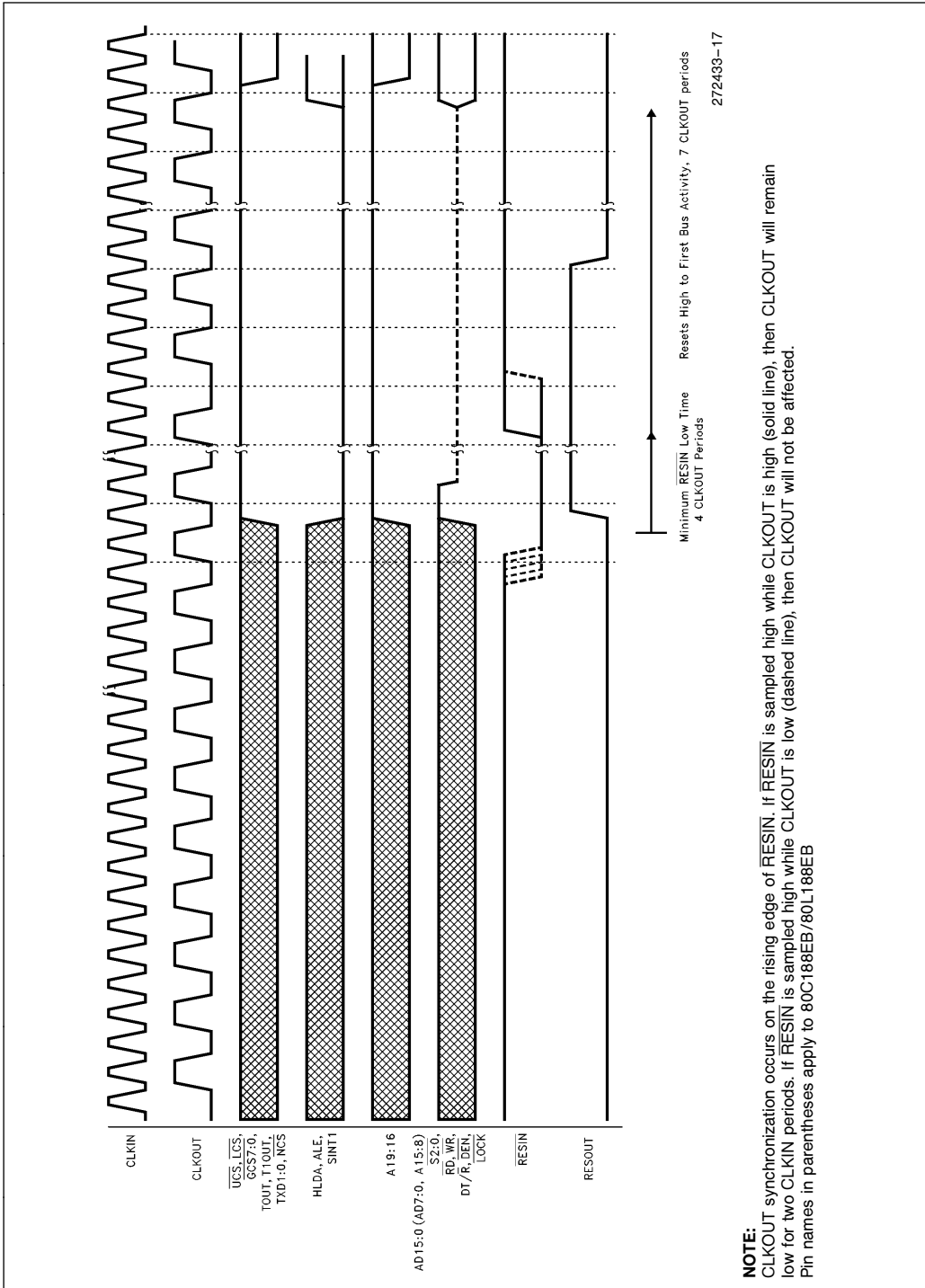
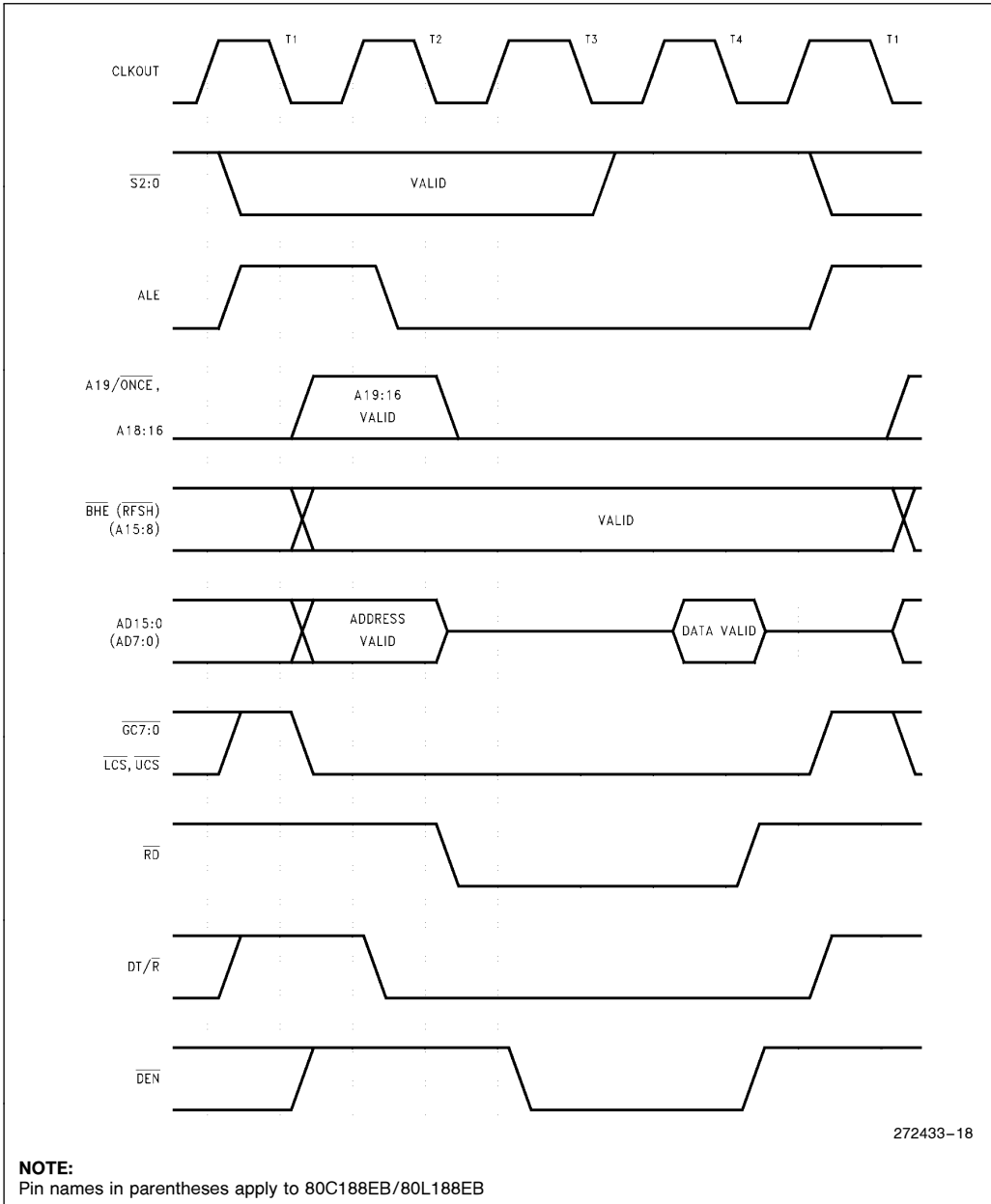

Figure 16. Warm Reset Waveforms

**BUS CYCLE WAVEFORMS**

Figures 17 through 23 present the various bus cycles that are generated by the processor. What is shown in the figure is the relationship of the various

bus signals to CLKOUT. These figures along with the information present in **AC Specifications** allow the user to determine all the critical timing analysis needed for a given application.



**Figure 17. Read, Fetch, and Refresh Cycle Waveforms**



Figure 18. Write Cycle Waveforms

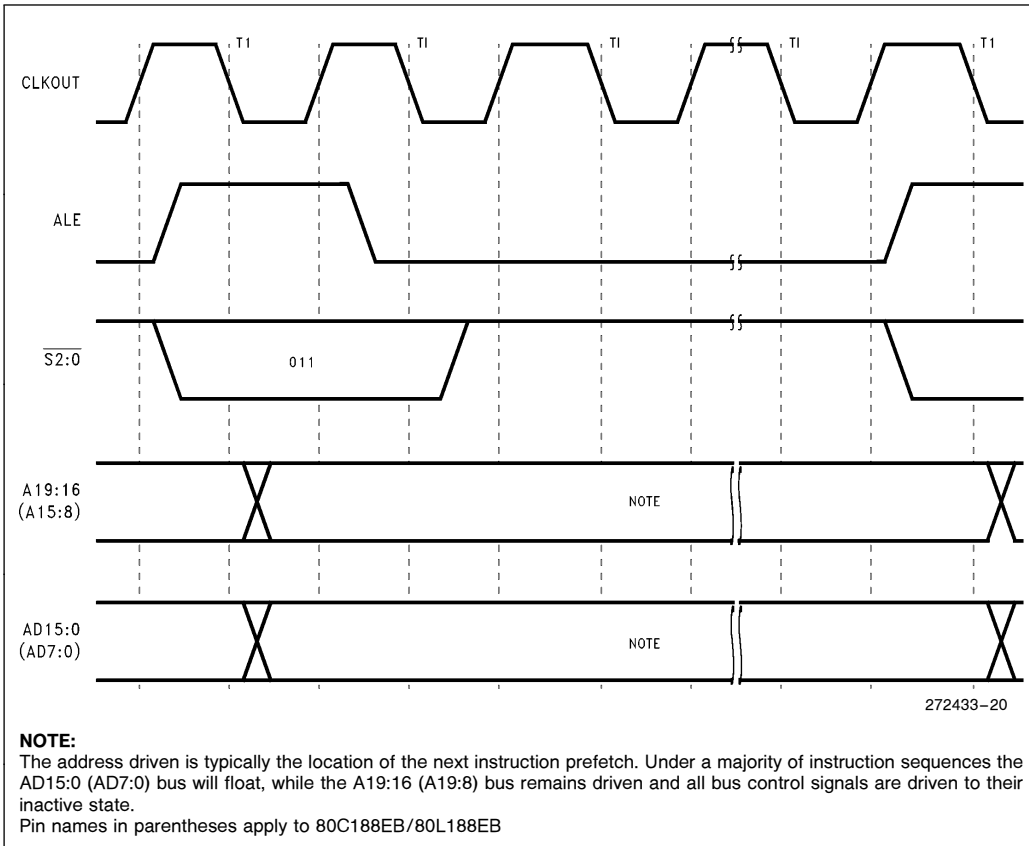

Figure 19. Halt Cycle Waveforms

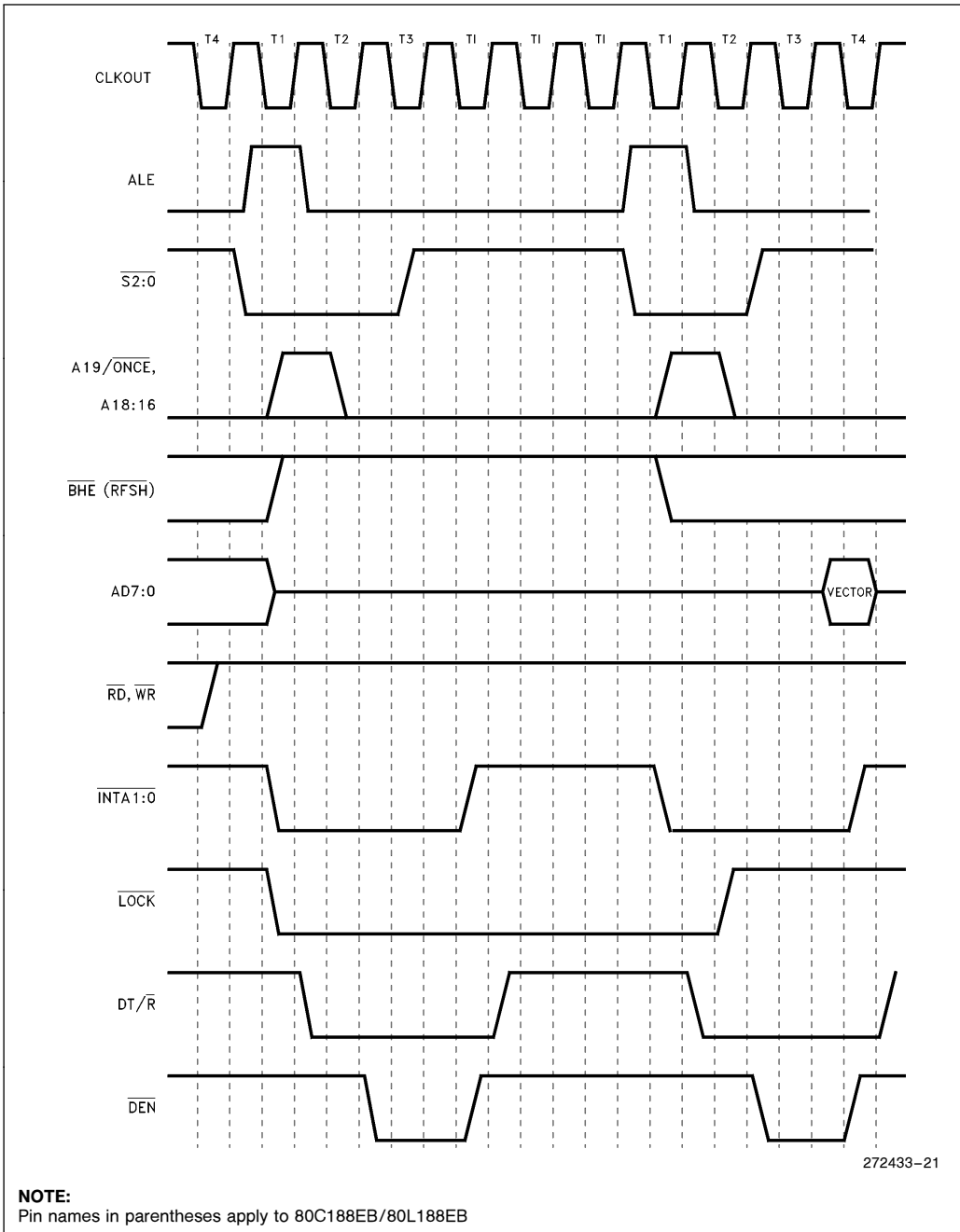

Figure 20. Interrupt Acknowledge Cycle Waveform



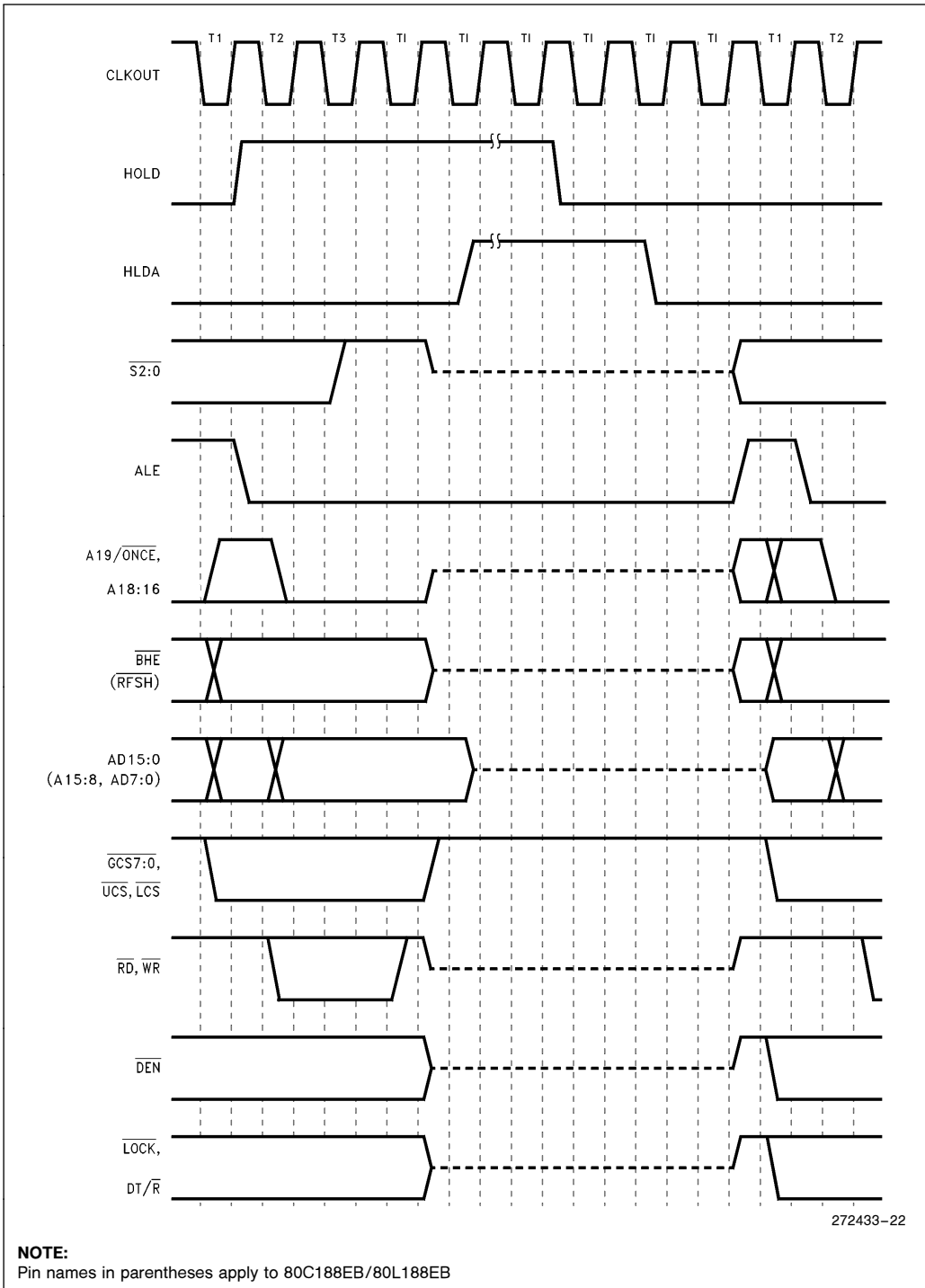

Figure 21. HOLD/HLDA Waveforms

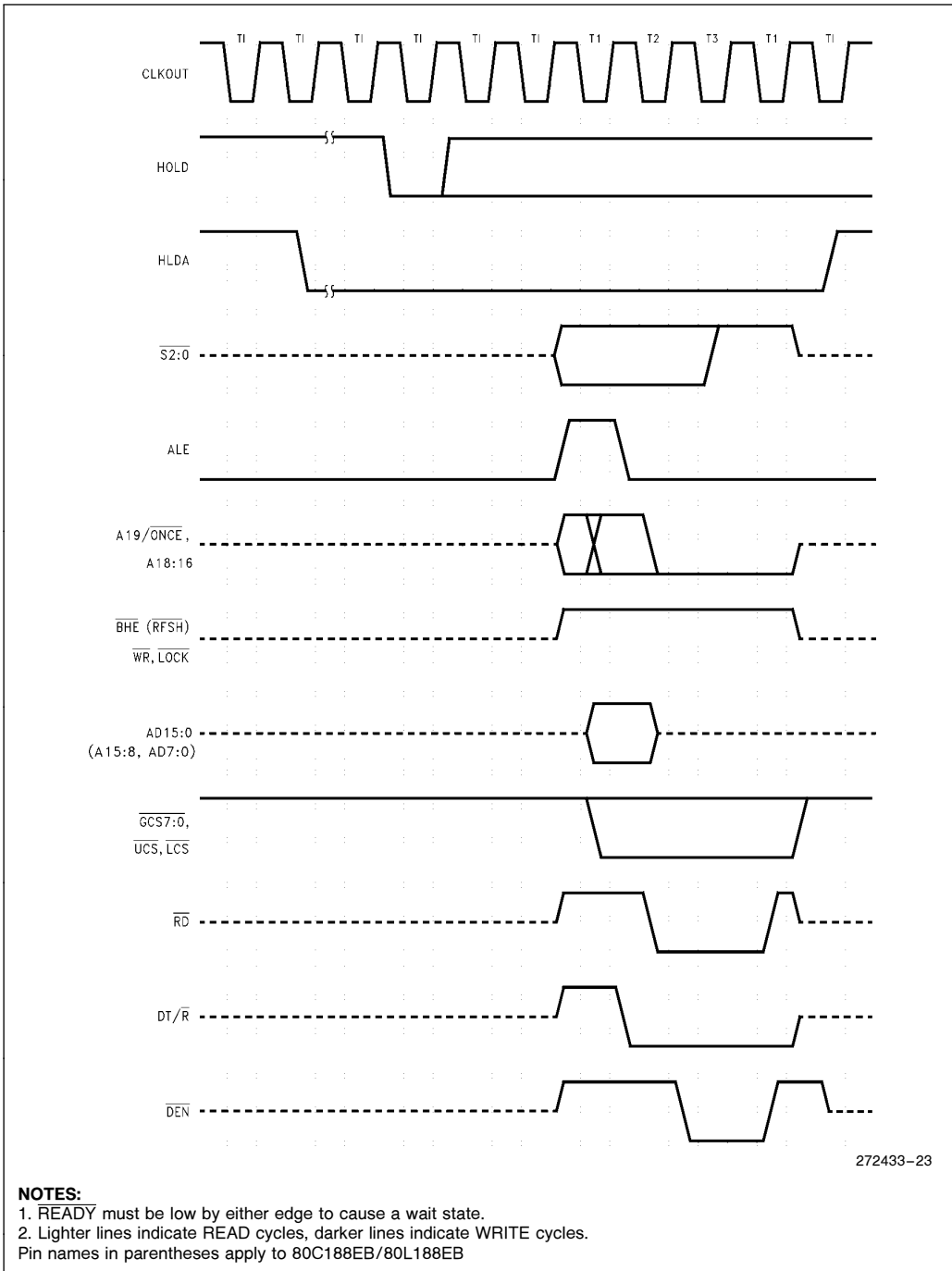

Figure 22. Refresh during Hold Acknowledge



Figure 23. Ready Waveforms



## EXECUTION TIMINGS

A determination of program execution timing must consider the bus cycles necessary to prefetch instructions as well as the number of execution unit cycles necessary to execute instructions. The following instruction timings represent the **minimum** execution time in clock cycles for each instruction. The timings given are based on the following assumptions:

- The opcode, along with any data or displacement required for execution of a particular instruction, has been prefetched and resides in the queue at the time it is needed.
- No wait states or bus HOLDs occur.
- All word-data is located on even-address boundaries (80C186EB only).

All jumps and calls include the time required to fetch the opcode of the next instruction at the destination address.

All instructions which involve memory accesses can require one or two additional clocks above the minimum timings shown due to the asynchronous handshake between the bus interface unit (BIU) and execution unit.

With a 16-bit BIU, the 80C186EB has sufficient bus performance to ensure that an adequate number of prefetched bytes will reside in the queue (6 bytes) most of the time. Therefore, actual program execution time will not be substantially greater than that derived from adding the instruction timings shown.

The 80C188EB 8-bit BIU is limited in its performance relative to the execution unit. A sufficient number of prefetched bytes may not reside in the prefetch queue (4 bytes) much of the time. Therefore, actual program execution time will be substantially greater than that derived from adding the instruction timings shown.



**INSTRUCTION SET SUMMARY**

Function	Format	80C186EB Clock Cycles	80C188EB Clock Cycles	Comments
<b>DATA TRANSFER</b>				
<b>MOV = Move:</b>				
Register to Register/Memory	1 0 0 0 1 0 0 w mod reg r/m	2/12	2/12*	
Register/memory to register	1 0 0 0 1 0 1 w mod reg r/m	2/9	2/9*	
Immediate to register/memory	1 1 0 0 0 1 1 w mod 000 r/m data data if w = 1	12/13	12/13	8/16-bit
Immediate to register	1 0 1 1 w reg data data if w = 1	3/4	3/4	8/16-bit
Memory to accumulator	1 0 1 0 0 0 0 w addr-low addr-high	8	8*	
Accumulator to memory	1 0 1 0 0 0 1 w addr-low addr-high	9	9*	
Register/memory to segment register	1 0 0 0 1 1 1 0 mod 0 reg r/m	2/9	2/13	
Segment register to register/memory	1 0 0 0 1 1 0 0 mod 0 reg r/m	2/11	2/15	
<b>PUSH = Push:</b>				
Memory	1 1 1 1 1 1 1 1 mod 1 1 0 r/m	16	20	
Register	0 1 0 1 0 reg	10	14	
Segment register	0 0 0 reg 1 1 0	9	13	
Immediate	0 1 1 0 1 0 s 0 data data if s = 0	10	14	
<b>PUSHA = Push All</b>				
0 1 1 0 0 0 0 0		36	68	
<b>POP = Pop:</b>				
Memory	1 0 0 0 1 1 1 1 mod 0 0 0 r/m	20	24	
Register	0 1 0 1 1 reg	10	14	
Segment register	0 0 0 reg 1 1 1 (reg ≠ 01)	8	12	
<b>POPA = Pop All</b>				
0 1 1 0 0 0 0 1		51	83	
<b>XCHG = Exchange:</b>				
Register/memory with register	1 0 0 0 0 1 1 w mod reg r/m	4/17	4/17*	
Register with accumulator	1 0 0 1 0 reg	3	3	
<b>IN = Input from:</b>				
Fixed port	1 1 1 0 0 1 0 w port	10	10*	
Variable port	1 1 1 0 1 1 0 w	8	8*	
<b>OUT = Output to:</b>				
Fixed port	1 1 1 0 0 1 1 w port	9	9*	
Variable port	1 1 1 0 1 1 1 w	7	7*	
<b>XLAT = Translate byte to AL</b>	1 1 0 1 0 1 1 1	11	15	
<b>LEA = Load EA to register</b>	1 0 0 0 1 1 0 1 mod reg r/m	6	6	
<b>LDS = Load pointer to DS</b>	1 1 0 0 0 1 0 1 mod reg r/m (mod ≠ 11)	18	26	
<b>LES = Load pointer to ES</b>	1 1 0 0 0 1 0 0 mod reg r/m (mod ≠ 11)	18	26	
<b>LAHF = Load AH with flags</b>	1 0 0 1 1 1 1 1	2	2	
<b>SAHF = Store AH into flags</b>	1 0 0 1 1 1 1 0	3	3	
<b>PUSHF = Push flags</b>	1 0 0 1 1 1 0 0	9	13	
<b>POPF = Pop flags</b>	1 0 0 1 1 1 0 1	8	12	

Shaded areas indicate instructions not available in 8086/8088 microsystems.

**NOTE:**

\*Clock cycles shown for byte transfers. For word operations, add 4 clock cycles for all memory transfers.

**PRELIMINARY**



**INSTRUCTION SET SUMMARY** (Continued)

Function	Format	80C186EB Clock Cycles	80C188EB Clock Cycles	Comments
<b>DATA TRANSFER</b> (Continued)				
<b>SEGMENT = Segment Override:</b>				
<b>CS</b>	00101110	2	2	
<b>SS</b>	00110110	2	2	
<b>DS</b>	00111110	2	2	
<b>ES</b>	00100110	2	2	
<b>ARITHMETIC</b>				
<b>ADD = Add:</b>				
Reg/memory with register to either	000000dw mod reg r/m	3/10	3/10*	
Immediate to register/memory	100000sw mod 000 r/m data data if sw=01	4/16	4/16*	
Immediate to accumulator	0000010w data data if w=1	3/4	3/4	8/16-bit
<b>ADC = Add with carry:</b>				
Reg/memory with register to either	000100dw mod reg r/m	3/10	3/10*	
Immediate to register/memory	100000sw mod 010 r/m data data if sw=01	4/16	4/16*	
Immediate to accumulator	0001010w data data if w=1	3/4	3/4	8/16-bit
<b>INC = Increment:</b>				
Register/memory	1111111w mod 000 r/m	3/15	3/15*	
Register	01000 reg	3	3	
<b>SUB = Subtract:</b>				
Reg/memory and register to either	001010dw mod reg r/m	3/10	3/10*	
Immediate from register/memory	100000sw mod 101 r/m data data if sw=01	4/16	4/16*	
Immediate from accumulator	0010110w data data if w=1	3/4	3/4	8/16-bit
<b>SBB = Subtract with borrow:</b>				
Reg/memory and register to either	000110dw mod reg r/m	3/10	3/10*	
Immediate from register/memory	100000sw mod 011 r/m data data if sw=01	4/16	4/16*	
Immediate from accumulator	0001110w data data if w=1	3/4	3/4*	8/16-bit
<b>DEC = Decrement</b>				
Register/memory	1111111w mod 001 r/m	3/15	3/15*	
Register	01001 reg	3	3	
<b>CMP = Compare:</b>				
Register/memory with register	0011101w mod reg r/m	3/10	3/10*	
Register with register/memory	0011100w mod reg r/m	3/10	3/10*	
Immediate with register/memory	100000sw mod 111 r/m data data if sw=01	3/10	3/10*	
Immediate with accumulator	0011110w data data if w=1	3/4	3/4	8/16-bit
<b>NEG = Change sign register/memory</b>	1111011w mod 011 r/m	3/10	3/10*	
<b>AAA = ASCII adjust for add</b>	00110111	8	8	
<b>DAA = Decimal adjust for add</b>	00100111	4	4	
<b>AAS = ASCII adjust for subtract</b>	00111111	7	7	
<b>DAS = Decimal adjust for subtract</b>	00101111	4	4	
<b>MUL = Multiply (unsigned):</b>				
Register-Byte	1111011w mod 100 r/m	26-28	26-28	
Register-Word		35-37	35-37	
Memory-Byte		32-34	32-34	
Memory-Word		41-43	41-43*	

Shaded areas indicate instructions not available in 8086/8088 microsystems.

**NOTE:**

\*Clock cycles shown for byte transfers. For word operations, add 4 clock cycles for all memory transfers.



**INSTRUCTION SET SUMMARY** (Continued)

Function	Format	80C186EB Clock Cycles	80C188EB Clock Cycles	Comments
<b>ARITHMETIC</b> (Continued)				
<b>IMUL</b> = Integer multiply (signed):	1 1 1 1 0 1 1 w   mod 1 0 1 r/m			
Register-Byte		25-28	25-28	
Register-Word		34-37	34-37	
Memory-Byte		31-34	31-34	
Memory-Word		40-43	40-43*	
<b>IMUL</b> = Integer Immediate multiply (signed)	0 1 1 0 1 0 s 1   mod reg r/m   data   data if s = 0	22-25/ 29-32	22-25/ 29-32	
<b>DIV</b> = Divide (unsigned):	1 1 1 1 0 1 1 w   mod 1 1 0 r/m			
Register-Byte		29	29	
Register-Word		38	38	
Memory-Byte		35	35	
Memory-Word		44	44*	
<b>IDIV</b> = Integer divide (signed):	1 1 1 1 0 1 1 w   mod 1 1 1 r/m			
Register-Byte		44-52	44-52	
Register-Word		53-61	53-61	
Memory-Byte		50-58	50-58	
Memory-Word		59-67	59-67*	
<b>AAM</b> = ASCII adjust for multiply	1 1 0 1 0 1 0 0   0 0 0 0 1 0 1 0	19	19	
<b>AAD</b> = ASCII adjust for divide	1 1 0 1 0 1 0 1   0 0 0 0 1 0 1 0	15	15	
<b>CBW</b> = Convert byte to word	1 0 0 1 1 0 0 0	2	2	
<b>CWD</b> = Convert word to double word	1 0 0 1 1 0 0 1	4	4	
<b>LOGIC</b>				
<b>Shift/Rotate Instructions:</b>				
Register/Memory by 1	1 1 0 1 0 0 0 w   mod TTT r/m	2/15	2/15	
Register/Memory by CL	1 1 0 1 0 0 1 w   mod TTT r/m	5 + n/17 + n	5 + n/17 + n	
Register/Memory by Count	1 1 0 0 0 0 0 w   mod TTT r/m   count	5 + n/17 + n	5 + n/17 + n	
<b>TTT Instruction</b>				
0 0 0 ROL				
0 0 1 ROR				
0 1 0 RCL				
0 1 1 RCR				
1 0 0 SHL/SAL				
1 0 1 SHR				
1 1 1 SAR				
<b>AND = And:</b>				
Reg/memory and register to either	0 0 1 0 0 0 d w   mod reg r/m	3/10	3/10*	
Immediate to register/memory	1 0 0 0 0 0 0 w   mod 1 0 0 r/m   data   data if w = 1	4/16	4/16*	
Immediate to accumulator	0 0 1 0 0 1 0 w   data   data if w = 1	3/4	3/4*	8/16-bit
<b>TEST = And function to flags, no result:</b>				
Register/memory and register	1 0 0 0 0 1 0 w   mod reg r/m	3/10	3/10*	
Immediate data and register/memory	1 1 1 1 0 1 1 w   mod 0 0 0 r/m   data   data if w = 1	4/10	4/10*	
Immediate data and accumulator	1 0 1 0 1 0 0 w   data   data if w = 1	3/4	3/4	8/16-bit
<b>OR = Or:</b>				
Reg/memory and register to either	0 0 0 0 1 0 d w   mod reg r/m	3/10	3/10*	
Immediate to register/memory	1 0 0 0 0 0 0 w   mod 0 0 1 r/m   data   data if w = 1	4/16	4/16*	
Immediate to accumulator	0 0 0 0 1 1 0 w   data   data if w = 1	3/4	3/4*	8/16-bit

Shaded areas indicate instructions not available in 8086/8088 microsystems.

**NOTE:**

\*Clock cycles shown for byte transfers. For word operations, add 4 clock cycles for all memory transfers.

**INSTRUCTION SET SUMMARY** (Continued)

Function	Format	80C186EB Clock Cycles	80C188EB Clock Cycles	Comments
<b>LOGIC</b> (Continued)				
<b>XOR = Exclusive or:</b>				
Reg/memory and register to either	0 0 1 1 0 0 d w    mod reg r/m	3/10	3/10*	
Immediate to register/memory	1 0 0 0 0 0 0 w    mod 1 1 0 r/m    data    data if w = 1	4/16	4/16*	
Immediate to accumulator	0 0 1 1 0 1 0 w    data    data if w = 1	3/4	3/4	8/16-bit
<b>NOT</b> = Invert register/memory	1 1 1 1 0 1 1 w    mod 0 1 0 r/m	3/10	3/10*	
<b>STRING MANIPULATION</b>				
<b>MOVS</b> = Move byte/word	1 0 1 0 0 1 0 w	14	14*	
<b>CMPS</b> = Compare byte/word	1 0 1 0 0 1 1 w	22	22*	
<b>SCAS</b> = Scan byte/word	1 0 1 0 1 1 1 w	15	15*	
<b>LODS</b> = Load byte/wd to AL/AX	1 0 1 0 1 1 0 w	12	12*	
<b>STOS</b> = Store byte/wd from AL/AX	1 0 1 0 1 0 1 w	10	10*	
<b>INS</b> = Input byte/wd from DX port	0 1 1 0 1 1 0 w	14	14	
<b>OUTS</b> = Output byte/wd to DX port	0 1 1 0 1 1 1 w	14	14	
Repeated by count in CX (REP/REPE/REPZ/REPNE/REPNZ)				
<b>MOVS</b> = Move string	1 1 1 1 0 0 1 0    1 0 1 0 0 1 0 w	8 + 8n	8 + 8n*	
<b>CMPS</b> = Compare string	1 1 1 1 0 0 1 z    1 0 1 0 0 1 1 w	5 + 22n	5 + 22n*	
<b>SCAS</b> = Scan string	1 1 1 1 0 0 1 z    1 0 1 0 1 1 1 w	5 + 15n	5 + 15n*	
<b>LODS</b> = Load string	1 1 1 1 0 0 1 0    1 0 1 0 1 1 0 w	6 + 11n	6 + 11n*	
<b>STOS</b> = Store string	1 1 1 1 0 0 1 0    1 0 1 0 1 0 1 w	6 + 9n	6 + 9n*	
<b>INS</b> = Input string	1 1 1 1 0 0 1 0    0 1 1 0 1 1 0 w	8 + 8n	8 + 8n*	
<b>OUTS</b> = Output string	1 1 1 1 0 0 1 0    0 1 1 0 1 1 1 w	8 + 8n	8 + 8n*	
<b>CONTROL TRANSFER</b>				
<b>CALL = Call:</b>				
Direct within segment	1 1 1 0 1 0 0 0    disp-low    disp-high	15	19	
Register/memory indirect within segment	1 1 1 1 1 1 1 1    mod 0 1 0 r/m	13/19	17/27	
Direct intersegment	1 0 0 1 1 0 1 0    segment offset segment selector	23	31	
Indirect intersegment	1 1 1 1 1 1 1 1    mod 0 1 1 r/m    (mod ≠ 11)	38	54	
<b>JMP = Unconditional jump:</b>				
Short/long	1 1 1 0 1 0 1 1    disp-low	14	14	
Direct within segment	1 1 1 0 1 0 0 1    disp-low    disp-high	14	14	
Register/memory indirect within segment	1 1 1 1 1 1 1 1    mod 1 0 0 r/m	11/17	11/21	
Direct intersegment	1 1 1 0 1 0 1 0    segment offset segment selector	14	14	
Indirect intersegment	1 1 1 1 1 1 1 1    mod 1 0 1 r/m    (mod ≠ 11)	26	34	

Shaded areas indicate instructions not available in 8086/8088 microsystems.

**NOTE:**

\*Clock cycles shown for byte transfers. For word operations, add 4 clock cycles for all memory transfers.



**INSTRUCTION SET SUMMARY** (Continued)

Function	Format	80C186EB Clock Cycles	80C188EB Clock Cycles	Comments	
<b>CONTROL TRANSFER</b> (Continued)					
<b>RET = Return from CALL:</b>					
Within segment	1 1 0 0 0 0 1 1	16	20		
Within seg adding immed to SP	1 1 0 0 0 0 1 0    data-low    data-high	18	22		
Intersegment	1 1 0 0 1 0 1 1	22	30		
Intersegment adding immediate to SP	1 1 0 0 1 0 1 0    data-low    data-high	25	33		
<b>JE/JZ</b> = Jump on equal/zero	0 1 1 1 0 1 0 0    disp	4/13	4/13	JMP not taken/JMP taken	
<b>JL/JNGE</b> = Jump on less/not greater or equal	0 1 1 1 1 1 0 0    disp	4/13	4/13		
<b>JLE/JNG</b> = Jump on less or equal/not greater	0 1 1 1 1 1 1 0    disp	4/13	4/13		
<b>JB/JNAE</b> = Jump on below/not above or equal	0 1 1 1 0 0 1 0    disp	4/13	4/13		
<b>JBE/JNA</b> = Jump on below or equal/not above	0 1 1 1 0 1 1 0    disp	4/13	4/13		
<b>JP/JPE</b> = Jump on parity/parity even	0 1 1 1 1 0 1 0    disp	4/13	4/13		
<b>JO</b> = Jump on overflow	0 1 1 1 0 0 0 0    disp	4/13	4/13		
<b>JS</b> = Jump on sign	0 1 1 1 1 0 0 0    disp	4/13	4/13		
<b>JNE/JNZ</b> = Jump on not equal/not zero	0 1 1 1 0 1 0 1    disp	4/13	4/13		
<b>JNL/JGE</b> = Jump on not less/greater or equal	0 1 1 1 1 1 0 1    disp	4/13	4/13		
<b>JNLE/JG</b> = Jump on not less or equal/greater	0 1 1 1 1 1 1 1    disp	4/13	4/13		
<b>JNB/JAE</b> = Jump on not below/above or equal	0 1 1 1 0 0 1 1    disp	4/13	4/13		
<b>JNBE/JA</b> = Jump on not below or equal/above	0 1 1 1 0 1 1 1    disp	4/13	4/13		
<b>JNP/JPO</b> = Jump on not par/par odd	0 1 1 1 1 0 1 1    disp	4/13	4/13		
<b>JNO</b> = Jump on not overflow	0 1 1 1 0 0 0 1    disp	4/13	4/13		
<b>JNS</b> = Jump on not sign	0 1 1 1 1 0 0 1    disp	4/13	4/13		
<b>JCXZ</b> = Jump on CX zero	1 1 1 0 0 0 1 1    disp	5/15	5/15		
<b>LOOP</b> = Loop CX times	1 1 1 0 0 0 1 0    disp	6/16	6/16		LOOP not taken/LOOP taken
<b>LOOPZ/LOOPE</b> = Loop while zero/equal	1 1 1 0 0 0 0 1    disp	6/16	6/16		
<b>LOOPNZ/LOOPNE</b> = Loop while not zero/equal	1 1 1 0 0 0 0 0    disp	6/16	6/16		
<b>ENTER</b> = Enter Procedure L = 0 L = 1 L > 1	1 1 0 0 1 0 0 0    data-low    data-high    L	15 25 22 + 16(n - 1)	19 29 26 + 20(n - 1)		
<b>LEAVE</b> = Leave Procedure	1 1 0 0 1 0 0 1	8	8		
<b>INT = Interrupt:</b>					
Type specified	1 1 0 0 1 1 0 1    type	47	47	if INT. taken/ if INT. not taken	
Type 3	1 1 0 0 1 1 0 0	45	45		
<b>INTO</b> = Interrupt on overflow	1 1 0 0 1 1 1 0	48/4	48/4		
<b>IRET</b> = Interrupt return	1 1 0 0 1 1 1 1	28	28		
<b>BOUND</b> = Detect value out of range	0 1 1 0 0 0 1 0    mod reg r/m	33-35	33-35		

Shaded areas indicate instructions not available in 8086/8088 microsystems.

**NOTE:**

\*Clock cycles shown for byte transfers. For word operations, add 4 clock cycles for all memory transfers.



**INSTRUCTION SET SUMMARY** (Continued)

Function	Format	80C186EB Clock Cycles	80C188EB Clock Cycles	Comments
<b>PROCESSOR CONTROL</b>				
CLC = Clear carry	11111000	2	2	
CMC = Complement carry	11110101	2	2	
STC = Set carry	11111001	2	2	
CLD = Clear direction	11111100	2	2	
STD = Set direction	11111101	2	2	
CLI = Clear interrupt	11111010	2	2	
STI = Set interrupt	11111011	2	2	
HLT = Halt	11110100	2	2	
WAIT = Wait	10011011	6	6	if TEST = 0
LOCK = Bus lock prefix	11110000	2	2	
NOP = No Operation	10010000	3	3	

(TTT LLL are opcode to processor extension)

Shaded areas indicate instructions not available in 8086/8088 microsystems.

**NOTE:**

\*Clock cycles shown for byte transfers. For word operations, add 4 clock cycles for all memory transfers.

**FOOTNOTES**

The Effective Address (EA) of the memory operand is computed according to the mod and r/m fields:

- if mod = 11 then r/m is treated as a REG field
- if mod = 00 then DISP = 0\*, disp-low and disp-high are absent
- if mod = 01 then DISP = disp-low sign-extended to 16-bits, disp-high is absent
- if mod = 10 then DISP = disp-high: disp-low
- if r/m = 000 then EA = (BX) + (SI) + DISP
- if r/m = 001 then EA = (BX) + (DI) + DISP
- if r/m = 010 then EA = (BP) + (SI) + DISP
- if r/m = 011 then EA = (BP) + (DI) + DISP
- if r/m = 100 then EA = (SI) + DISP
- if r/m = 101 then EA = (DI) + DISP
- if r/m = 110 then EA = (BP) + DISP\*
- if r/m = 111 then EA = (BX) + DISP

DISP follows 2nd byte of instruction (before data if required)

\*except if mod = 00 and r/m = 110 then EA = disp-high: disp-low.

EA calculation time is 4 clock cycles for all modes, and is included in the execution times given whenever appropriate.

**Segment Override Prefix**

0	0	1	reg	1	1	0
---	---	---	-----	---	---	---

reg is assigned according to the following:

reg	Segment Register
00	ES
01	CS
10	SS
11	DS

REG is assigned according to the following table:

16-Bit (w = 1)	8-Bit (w = 0)
000 AX	000 AL
001 CX	001 CL
010 DX	010 DL
011 BX	011 BL
100 SP	100 AH
101 BP	101 CH
110 SI	110 DH
111 DI	111 BH

The physical addresses of all operands addressed by the BP register are computed using the SS segment register. The physical addresses of the destination operands of the string primitive operations (those addressed by the DI register) are computed using the ES segment, which may not be overridden.

**ERRATA**

An 80C186EB/80L186EB with a STEPID value of 0001H has the following known errata. A device with a STEPID of 0001H can be visually identified by the **presence** of an “A” alpha character next to the FPO number. The FPO number location is shown in Figures 4, 5 and 6.

1. A19/ $\overline{\text{ONCE}}$  is not latched by the rising edge of  $\overline{\text{RESIN}}$ . A19/ $\overline{\text{ONCE}}$  must remain active (LOW) at all times to remain in the ONCE Mode. Removing A19/ $\overline{\text{ONCE}}$  after  $\overline{\text{RESIN}}$  is high will return all output pins to a driving state, however, the 80C186EB will remain in a reset state.
2. During interrupt acknowledge (INTA) bus cycles, the bus controller will ignore the state of the READY pin if the previous bus cycle ignored the state of the READY pin. This errata can only occur if the Chip-Select Unit is being used. All active chip-selects must be programmed to use READY (RDY bit must be programmed to a 1) if wait-states are required for INTA bus cycles.
3. CLKOUT will transition off the **rising** edge of CLKIN rather than the falling edge of CLKIN. This does not affect any bus timings other than  $T_{\text{CD}}$ .
4.  $\overline{\text{RESIN}}$  has a hysteresis of only 130 mV. It is recommended that  $\overline{\text{RESIN}}$  be driven by a Schmitt triggered device to avoid processor lockup during reset using an RC circuit.

5. SINT1 will only go active for one clock period when a receive or transmit interrupt is pending (i.e., it does not remain active until the S1STS register is read). If SINT1 is to be connected to any of the processor interrupt lines (INT0–INT4), then it must be latched by user logic.

An 80C186EB/80L186EB with a STEPID value of 0001H or 0002H has the following known errata. A device with a STEPID of 0002H can be visually identified by noting the presence of a “B”, “C”, “D”, or “E” alpha character next to the FPO number. The FPO number location is shown in Figures 4, 5 and 6.

1. An internal condition with the interrupt controller can cause no acknowledge cycle on the  $\overline{\text{INTA1}}$  line in response to INT1. This errata only occurs when Interrupt 1 is configured in cascade mode and a higher priority interrupt exists. This errata will not occur consistently, it is dependent on interrupt timing.

**REVISION HISTORY**

This data sheet replaces the following data sheets:

270803-004	80C186EB
270885-003	80C188EB
270921-003	80L186EB
270920-003	80L188EB
272311-001	SB80C188EB/SB80L188EB
272312-001	SB80C186EB/SB80L186EB