

L934GO/2ID HIGH EFFICIENCY RED  
 L934GO/2GD GREEN  
 L934GO/2YD YELLOW  
 L934GO/2SRD SUPER BRIGHT RED

### Features

- PRE-TRIMMED LEADS FOR PC MOUNTING.
- I.C. COMPATIBLE.
- BLACK CASE ENHANCES CONTRAST RATIO.
- WIDE VIEWING ANGLE.
- HIGH RELIABILITY LIFE MEASURED IN YEARS.
- UL RATING : 94V-0.
- HOUSING MATERIAL: TYPE 66 NYLON.

### Description

The High Efficiency Red source color devices are made with Gallium Arsenide Phosphide on Gallium Phosphide Orange Light Emitting Diode.

The Green source color devices are made with Gallium Phosphide Green Light Emitting Diode.

The Yellow source color devices are made with Gallium Arsenide Phosphide on Gallium Phosphide Yellow Light Emitting Diode.

The Super Bright Red source color devices are made with Gallium Aluminum Arsenide Red Light Emitting Diode.

### Package Dimensions

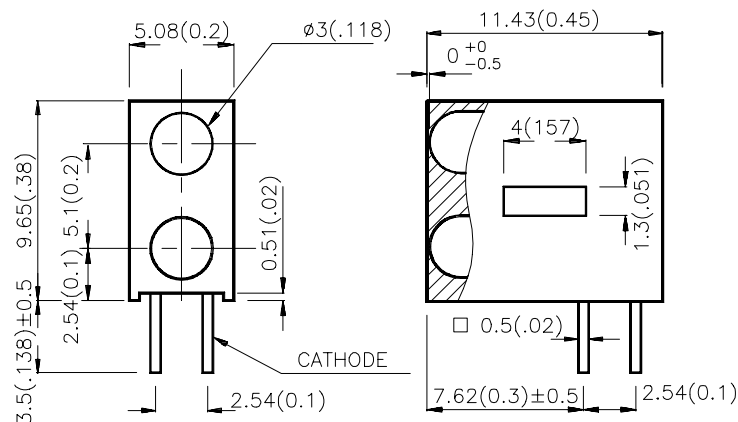

#### Notes:

1. All dimensions are in millimeters (inches).
2. Tolerance is  $\pm 0.25(0.01)$  unless otherwise noted.
3. Lead spacing is measured where the lead emerge package.
4. Specifications are subject to change without notice.

## Selection Guide

Part No.	Dice	Lens Type	Iv (mcd) @ 10 mA *20mA		Viewing Angle
			Min.	Typ.	2θ1/2
L934GO/2ID	HIGH EFFICIENCY RED(GaAsP/GaP)	RED DIFFUSED	8	25	60°
L934GO/2GD	GREEN (GaP)	GREEN DIFFUSED	8	20	60°
L934GO/2YD	YELLOW (GaAsP/GaP)	YELLOW DIFFUSED	5	15	60°
L34GO/2SRD	SUPER BRIGHT RED (GaAlAs)	RED DIFFUSED	*100	*300	60°

Notes:

1. θ1/2 is the angle from optical centerline where the luminous intensity is 1/2 the optical centerline value.
2. \* Luminous intensity with asterisk is measured at 20mA.

## Electrical / Optical Characteristics at T<sub>A</sub>=25°C

Symbol	Parameter	Device	Typ.	Max.	Units	Test Conditions
λ <sub>peak</sub>	Peak Wavelength	High Efficiency Red Green Yellow Super Bright Red	627 565 590 660		nm	IF=20mA
λ <sub>D</sub>	Dominate Wavelength	High Efficiency Red Green Yellow Super Bright Red	625 568 588 640		nm	IF=20mA
Δλ <sub>1/2</sub>	Spectral Line Halfwidth	High Efficiency Red Green Yellow Super Bright Red	45 30 35 20		nm	IF=20mA
C	Capacitance	High Efficiency Red Green Yellow Super Bright Red	15 15 20 45		pF	VF=0V;f=1MHz
V <sub>F</sub>	Forward Voltage	High Efficiency Red Green Yellow Super Bright Red	2.0 2.2 2.1 1.85	2.5 2.5 2.5 2.5	V	IF=20mA
I <sub>R</sub>	Reverse Current	All		10	uA	VR = 5V

## Absolute Maximum Ratings at T<sub>A</sub>=25°C

Parameter	High Efficiency Red	Green	Yellow	Super Bright Red	Units
Power dissipation	105	105	105	100	mW
DC Forward Current	30	25	30	30	mA
Peak Forward Current [1]	160	140	140	155	mA
Reverse Voltage	5	5	5	5	V
Operating/Storage Temperature	-40°C To +85°C				
Lead Solder Temperature [2]	260°C For 5 Seconds				

Notes:

1. 1/10 Duty Cycle, 0.1ms Pulse Width.
2. 4mm below package base.

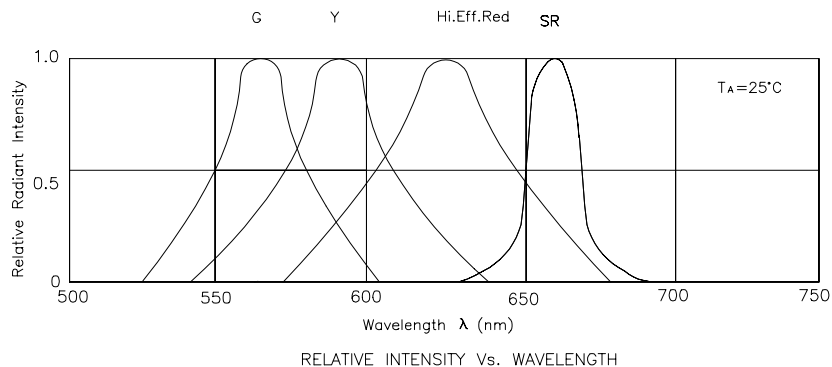

## High Efficiency Red L934GO/2ID

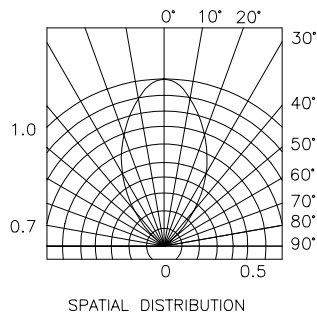
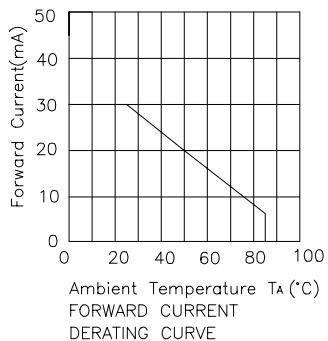
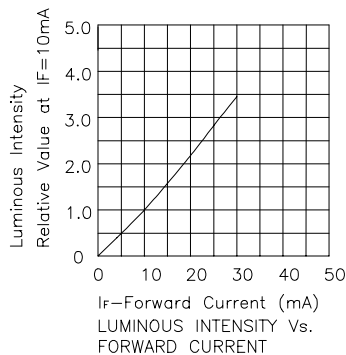
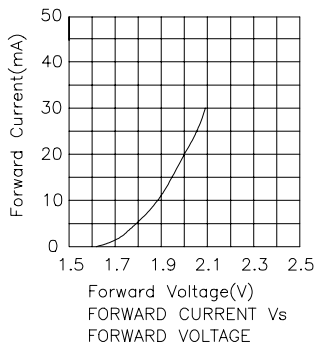

## Green L934GO/2GD

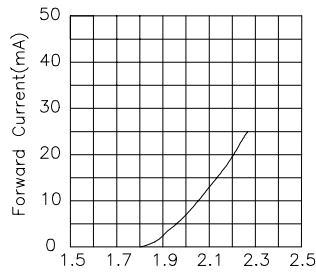

Forward Voltage(V)  
FORWARD CURRENT Vs  
FORWARD VOLTAGE

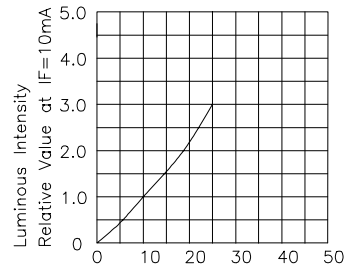

IF-Forward Current (mA)  
LUMINOUS INTENSITY Vs.  
FORWARD CURRENT

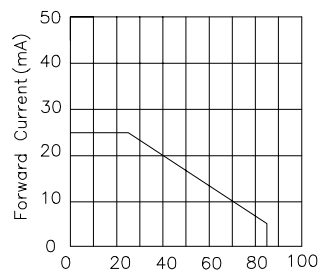

Ambient Temperature Ta (°C)  
FORWARD CURRENT  
DERATING CURVE

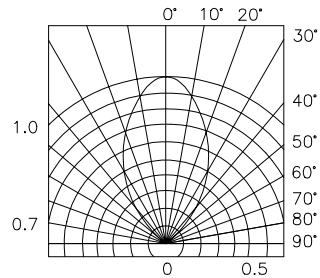

SPATIAL DISTRIBUTION

## Yellow L934GO/2YD

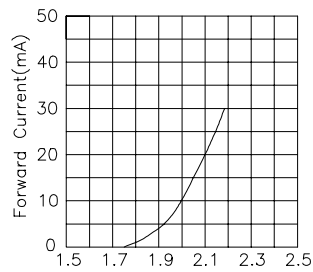

Forward Voltage(V)  
FORWARD CURRENT Vs.  
FORWARD VOLTAGE

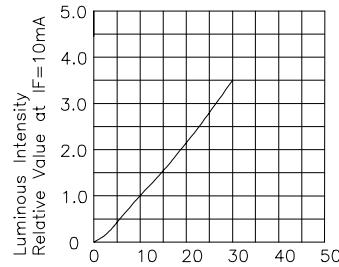

IF-Forward Current (mA)  
LUMINOUS INTENSITY Vs.  
FORWARD CURRENT

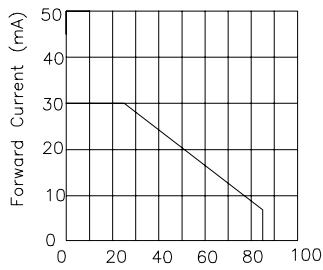

Ambient Temperature Ta (°C)  
FORWARD CURRENT  
DERATING CURVE

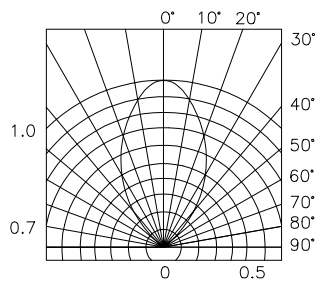

SPATIAL DISTRIBUTION

## Super Bright Red L934GO/2SRD

