

DEVICES for AUTOMOTIVE

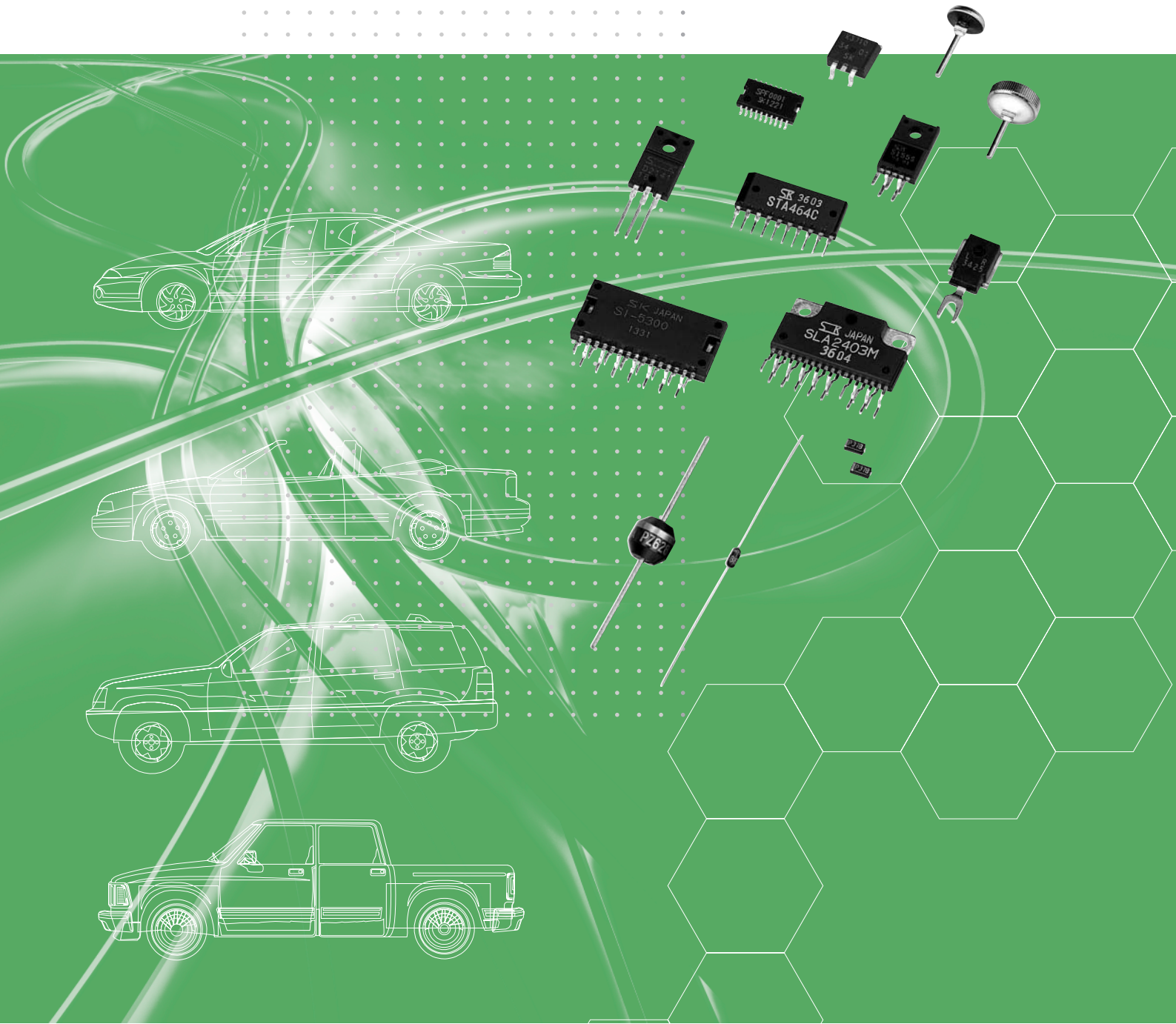

CAUTION / WARNING

- The information in this publication has been carefully checked and is believed to be accurate; however, no responsibility is assumed for inaccuracies.
- Sanken reserves the right to make changes without further notice to any products herein in the interest of improvements in the performance, reliability, or manufacturability of its products. Before placing an order, Sanken advises its customers to obtain the latest version of the relevant information to verify that the information being relied upon is current.
- Application and operation examples described in this catalog are quoted for the sole purpose of reference for the use of the products herein and Sanken can assume no responsibility for any infringement of industrial property rights, intellectual property rights or any other rights of Sanken or any third party which may result from its use.
- When using the products herein, the applicability and suitability of such products for the intended purpose or object shall be reviewed at the users responsibility.
- Although Sanken undertakes to enhance the quality and reliability of its products, the occurrence of failure and defect of semiconductor products at a certain rate is inevitable. Users of Sanken products are requested to take, at their own risk, preventative measures including safety design of the equipment or systems against any possible injury, death, fires or damages to the society due to device failure or malfunction.
- Sanken products listed in this catalog are designed and intended for the use as components in general purpose electronic equipment or apparatus (home appliances, office equipment, telecommunication equipment, measuring equipment, etc.). Before placing an order, the user's written consent to the specifications is requested.
- The use of Sanken products without the written consent of Sanken in the applications where extremely high reliability is required (aerospace equipment, nuclear power control systems, life support systems, etc.) is strictly prohibited.
- Anti radioactive ray design is not considered for the products listed herein.
- This publication shall not be reproduced in whole or in part without prior written approval from Sanken.
- Gallium arsenide is used in some of the products listed in this publication. These products are dangerous if they are burned or smashed in the process of disposal. It is also dangerous to drink the liquid or inhale the gas generated by such products when chemically disposed.

Contents

Examples of Use of Typical Products by Application	2
---	---

1 ICs

1-1. Regulator ICs	
Application Note	7
Dropper Type Regulator ICs	8
Dropper Type System Regulator ICs	16
Switching Type Regulator ICs	22
1-2. Power Switch ICs	
High-side Power Switch ICs	24
Low-side Switch ICs	50
1-3. Motor Driver ICs	
Stepper-motor Driver ICs	56
DC Motor Driver ICs	60
1-4. HID Lamp Driver ICs	64
1-5. Custom ICs	76

2 Discretes

2-1. Transistors	
2-1-1. Transistors	80
2-1-2. Transistor Arrays	96
2-2. MOS FETs	
2-2-1. MOS FETs	108
2-2-2. MOS FET Arrays	117
2-3. Thyristors	
2-3-1. Reverse Conducting Thyristors	125
2-4. Diodes	
2-4-1. Alternator Diodes	127
2-4-2. High-voltage Diodes for Igniter	128
2-4-3. Power Zener Diodes	129
2-4-4. General-purpose Diodes	130

3 LEDs

3-1. Uni-Color LED Lamps	134
3-2. Bi-Color LED Lamps	137
3-3. Surface Mount LEDs	138
3-4. Infrared LEDs	140
3-5. Ultraviolet LEDs	141
3-6. Multi-chip Modules	142

Part Number Index in Alphanumeric Order	147
--	-----

Examples of Use of Typical Products by Application

Alternators

- **Diodes** (p.127)
Solder and press fit type as well as Zener type is available.
SG-9 / SG-10 / SG-14
- **Regulator ICs**
Custom-made (contact our sales reps.)

Throttle System

- **DC Motor Driver ICs** (p.60 and after)
Control IC and full bridge power stage in a single package.
Surface-mounting type series are also available.
SI-5300 / SPF7301
- **Motor Driver Transistor Arrays** (p.99)
H-bridge of NPN x 2 and PNP x 2 in a single package.
With integrated back emf. clamp diode.
SLA8004
- **Motor driver power transistors** (p.68 and after)
With integrated back emf. clamp diode.
2SA1568 / 2SC4065

Fuel Injectors

- **Injector transistors** (p.84 and after)
Transistors and MOS FETs are available in discretes and arrays in various packages.
2SB1622 / 2SC4153 / 2SD2382 / MN611S / STA461C / STA463C / STA508A / SDC09 / SDK09 / SPF0001 / SSD103

Headlamps

- **HID lamp driver ICs** (p.64 and after)
High-voltage controller IC and 4-circuit power stage in a single package.
Direct drive from CPU.
SLA2402M / SLA2403M / SMA2409M
- **Thyristors for HID lamp ignition** (p.125 and after)
Best suited to C-discharge SW element on high-voltage primary side of an igniter.
Integrates a reverse direction diode.
High di/dt resistance
TFC561D / TFC562D
- **MOS FET arrays for driving HID lamps** (p.122)
4 circuits of N-ch MOS FETs of 450V/7A in a single package.
SMA5113
- **2-ph stepper-motor driver ICs for AFS** (p.58 and after)
Low output saturation voltage, integrated recovery diode, surface-mount.
SPF7211

Ignition System

- **High-voltage diodes for ignition** (p.128)
Withstand voltage range: 0.5 to 15kV
SHV-01JN / SHV-05J / SHV-06JN
- **Ignition transistors** (p.89 and after)
2SD2141 / MN638S
- **Ignition ICs**
Custom-made (contact our sales reps.)

Room Lamp

- Multi-chip LED modules (p.142)

Car Navigation and Audio

- Various LEDs (p.133)

Power Steering

- Motor driver MOS FETs (p.108 and after)
Various packages integrating low ON resistors, bidirectional Zener diodes, etc.
2SK3710 / 2SK3711 / 2SK3724 / 2SK3800 / 2SK3801 / 2SK3803 / 2SK3851

Tail Lamps

- Power LED
Custom-made
(contact our sales reps.)

O₂ sensor heater

- Heater driver MOS FETs (p.115)
Low ON resistor and integral gate protection diode.
FKV460S

Transmission

- AT solenoid drivers (high-side power switch ICs) (p.26 and after)
Integral diagnostic function, surface-mount, 2- and 3-circuit types and other diverse models.
SI-5151S / SPF5003 / SPF5004 / SPF5007 / SLA2502M
- AT linear solenoid driver (high-side power switch ICs) (p.46 and after)
Integral current detection resistor, current monitor output, surface-mount and 2-circuit types are also available.
SPF5017 / SPF5018

ABS and VDC

- Solenoid/motor driver MOS FETs (p.108 and after)
Various packages from discretes to arrays.
2SK3710 / FKV660S / SLA5027 / SDK08
- Solenoid/motor driver ICs (p.54)
Surface-mount 4-circuit type with output voltage monitor.
SPF5012

1

ICs

1-1. Regulator ICs

Application Note	7
Dropper Type Regulator ICs	8
SI-3001S (5V/1A, With Output ON/OFF Control)	8
SI-3003S (5V/0.8A, 3-terminal)	10
SI-3101S (5V/0.4A, 5V/0.07A, 2-output, With Output ON/OFF Control)	12
SI-3102S (5V/0.1A, 5V/0.04A, 2-output, With Output ON/OFF Control)	14
Dropper Type System Regulator ICs	16
SI-3322S (5V, Surface-mount)	16
SPF3004 (5V/0.4A, 3.3V/0.2A, Surface-mount 2-output)	18
SPF3006 (5V/0.4A, 5V/0.2A, Surface-mount 2-output)	20
Switching Type Regulator ICs	22
SI-3201S (5V/3A)	22

1-2. Power Switch ICs

High-side Power Switch ICs	24
SDH04 (With Diagnostic Function, Surface-mount 2-circuits)	24
SI-5151S (With Diagnostic Function)	26
SI-5152S (With Diagnostic Function)	28
SI-5153S (With Diagnostic Function, Built-in Zener Diode)	30
SI-5154S (With Diagnostic Function, Built-in Zener Diode)	32
SI-5155S (With Diagnostic Function)	34
SLA2501M (With Diagnostic Function, 3-circuits)	36
SLA2502M (With Diagnostic Function, 4-circuits)	38
SPF5003 (With Diagnostic Function, Surface-mount 2-circuits)	40
SPF5004 (With Diagnostic Function, Surface-mount 2-circuits)	42
SPF5007 (With Diagnostic Function, Surface-mount 3-circuits)	44
SPF5017 (Surface-mount 2-circuit, current monitor output function)	46
SPF5018 (Surface-mount, current monitor output function)	48
Low-side Switch ICs	50
SPF5002A (Surface-mount 4-circuits)	50
SPF5009 (With Diagnostic Function, Surface-mount 4-circuits)	52
SPF5012 (Surface-mount 4-circuits with Output Monitor)	54

1-3. Motor Driver ICs

Stepper-motor Driver ICs	56
SLA4708M (50V, 1.5A)	56
SPF7211 (40V, 0.8A)	58
DC Motor Driver ICs	60
SI-5300 (40V, 5A)	60
SPF7301 (36V, 7A)	62

1-4. HID Lamp Driver ICs

SLA2402M (500V, 15A)	64
SLA2403M (500V, 7A)	68
SMA2409M (500V, 7A)	72

1-5. Custom ICs

.....	76
-------	----

Application Note for Regulator ICs

■ Temperature and Reliability

Reliability of an IC is generally heavily dependent on operating temperature. Heat radiation must be fully considered, and an ample margin should be given to the radiating area in designing heatsinks. When mounting ICs on heatsinks, always apply silicone grease and firmly tighten. Air convection should actively be used in actual heat dissipation. The reliability of capacitors and coils, the peripheral components, is also closely related to temperature. A high operating temperature may reduce the service life. Exceeding the allowable temperature may cause coils to be burned or capacitors to be damaged. Make sure that output smoothing coils and input/output capacitors do not exceed their allowable temperature limit in operation. We recommend, in particular, to provide an ample margin for the ratings of coils to minimize heat generation.

■ Power Dissipation (P_D)

1. Dropper Type

$$P_D = I_O \cdot [V_{IN}(\text{mean}) - V_O]$$

2. Switching Type

$$P_D = V_O \cdot I_O \left(\frac{100}{\eta_x} - 1 \right) - V_F \cdot I_O \left(1 - \frac{V_O}{V_{IN}} \right)$$

Efficiency η_x depends on input/output conditions.

Refer to the efficiency characteristics.

V_O : Output voltage η_x : Efficiency

V_{IN} : Input voltage V_F : Diode forward voltage

I_O : Output current

■ Heatsink Design

The maximum junction temperature $T_j(\text{max})$ and the maximum case temperature $T_c(\text{max})$ given in the absolute maximum ratings are specific to each product type and must be strictly met. Thus, heatsink design must be performed in consideration of the condition of use which affects the maximum power dissipation $P_D(\text{max})$ and the maximum ambient temperature $T_a(\text{max})$. To facilitate heatsink design, the relationship between these two parameters is presented in the T_a - P_D characteristic graphs. Heatsink design must be performed in the following steps:

1. Obtain the maximum ambient temperature $T_a(\text{max})$ (within the set).
2. Obtain the maximum power dissipation $P_D(\text{max})$.
3. Identify the intersection on the T_a - P_D characteristic graph and obtain the size of the heatsink to be used.

The size of a heatsink has been obtained. In actual applications, a 10 to 20% derating factor is

generally used. Moreover, the heat dissipation capacity of a heatsink is heavily dependent on how it is mounted. It is therefore important and recommended to measure the heatsink and case temperature in actual operating environments.

■ Setting DC Input Voltage

Observe the following precautions when setting the DC input voltage:

- $V_{IN(\text{min})}$ must be at least the set output voltage plus dropout voltage for the dropper type. It must be at least the recommended lowest input voltage for the switching type.
- $V_{IN(\text{max})}$ must not exceed the DC input voltage of the electrical characteristics.

■ Screw Torque

Screw torque should be between 0.588 to 0.686 [N • m] (6.0 to 7.0 [kgf • cm]).

■ Recommended silicone grease

Volatile type silicone grease may produce cracks after elapse of long term, resulting in reducing heat radiation effect.

Silicone grease with low consistency (hard grease) may cause cracks in the mold resin when screwing the product to a heatsink.

Type	Suppliers
G746	Shin-Etsu Chemical Co., Ltd.
YG6260	GE Toshiba Silicones Co., Ltd.
SC102	Dow Corning Toray Silicone Co., Ltd.

■ Others

This product may not be connected in parallel. The switching type may not be used for current boosting and stepping up voltage.

Dropper Type Regulator ICs [With Output ON/OFF Control] SI-3001S

Features

- Output current of 1.0A
- 5-terminal type <output on/off control, variable output voltage (rise only)>
- Voltage accuracy of $\pm 2\%$
- Low dropout voltage $\leq 1V$ at $I_O \leq 1.0A$, $\leq 0.5V$ at $I_O \leq 0.4A$
- Built-in overcurrent, overvoltage and thermal protection circuits
- Withstands external electromagnetic noises
- TO220 equivalent full-mold package

Absolute Maximum Ratings

Parameter	Symbol	Ratings	Unit	Conditions
(Ta = 25°C)				
DC Input Voltage	V _{IN}	35	V	
Output Control Terminal Voltage	V _C	V _{IN}	V	
Output Current	I _O	1.0 *1	A	
Power Dissipation	P _{D1}	18	W	With infinite heatsink
	P _{D2}	1.5	W	Stand-alone without heatsink
Junction Temperature	T _J	-40 to +125	°C	
Operating Temperature	T _{OP}	-40 to +100	°C	
Storage Temperature	T _{stg}	-40 to +125	°C	
Junction to Case Thermal Resistance	θ_{j-c}	5.5	°C/W	
Junction to Ambient-Air Thermal Resistance	θ_{j-a}	66.7	°C/W	Stand-alone without heatsink

Electrical Characteristics

(T_J = 25°C, V_{IN} = 14V unless otherwise specified)

Parameter	Symbol	Ratings			Unit	Conditions	
		min	typ	max			
Input Voltage	V _{IN}	6 *2		30 *1	V		
Output Voltage	V _O	4.90	5.00	5.10	V	V _{IN} = 12 to 16V, I _O = 0.4A	
Dropout Voltage	V _{DIF}			0.5	V	I _O \leq 0.4A	
				1.0	V	I _O \leq 1.0A	
Line Regulation	$\Delta V_{O LINE}$			30	mV	I _O = 0.4A, V _{IN} = 6 to 16V	
Load Regulation	$\Delta V_{O LOAD}$			100	mV	I _O = 0 to 0.4A	
Output Voltage Temperature Coefficient	$\Delta V_{O}/\Delta T$		± 0.5		mV/°C	I _O = 5mA, Ta = -10 to +100°C	
Ripple Rejection	R _{REJ}		54		dB	f = 100 to 120Hz	
Quiescent Circuit Current	I _q		3	10	mA	I _O = 0A	
Overcurrent Protection Starting Current	I _{SI}	1.2 *3			A		
V _C Terminal	Control Voltage	Output ON	V _{C, IH}	2.0 *4	V		
		Output OFF	V _{C, IL}		0.8	V	
	Control Current	Output ON	I _{C, IH}		20	μA	V _C = 2.7V
		Output OFF	I _{C, IL}		-0.3	mA	V _C = 0.4V

Notes:

- *1. Since $P_{D(max)} = (V_{IN} - V_O) \cdot I_O = 18(W)$, V_{IN(max)} and I_{O(max)} may be limited depending on operating conditions. Refer to the Ta-P_D curve to compute the corresponding values.
- *2. Refer to the dropout voltage.
- *3. I_{SI} rating shall be the point at which the output voltage V_O (V_{IN} = 14V, I_O = 0.4A) drops to -5%.
- *4. The output control terminal V_C is pulled up inside the IC. Each input level can be directly driven with LS-TTL ICs. Thus, LS-TTL direct driving is also possible.

External Dimensions (unit: mm)

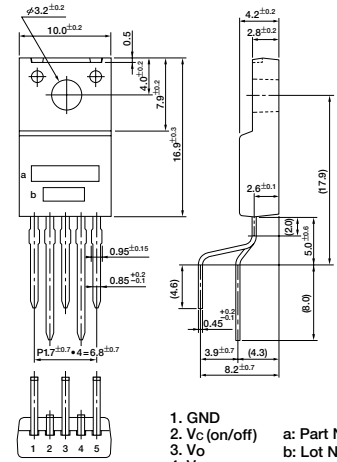

1. GND
 2. V_C (on/off)
 3. V_O
 4. V_{osense}
 5. V_{IN}
- a: Part No.
b: Lot No.
- (Forming No. 1101)

Equivalent Circuit Diagram

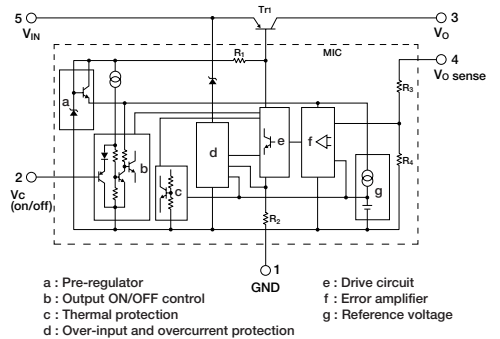

- a: Pre-regulator
b: Output ON/OFF control
c: Thermal protection
d: Over-input and overcurrent protection
e: Drive circuit
f: Error amplifier
g: Reference voltage

Standard Circuit Diagram

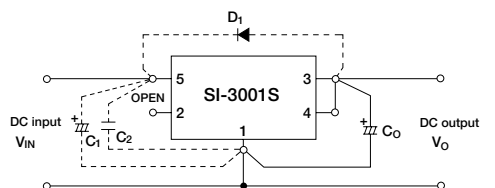

- Co: Output capacitor (47 to 100 μF, 50V)
C₁, C₂: Input capacitors (C₁: approx. 47 μF, C₂: approx. 0.33 μF). These are required for inductive input lines or long wiring. Tantalum capacitors are recommended for C₁ and C₂, especially at low temperatures.
D₁: Protection diode. Required as protection against reverse biasing between input and output. (Recommended diode: Sanken EU2Z.)

Electrical Characteristics

■ I_o vs V_{DIF} Characteristics

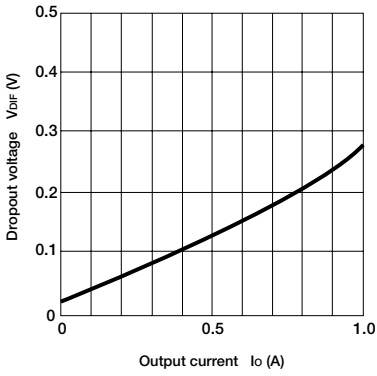

■ Line Regulation

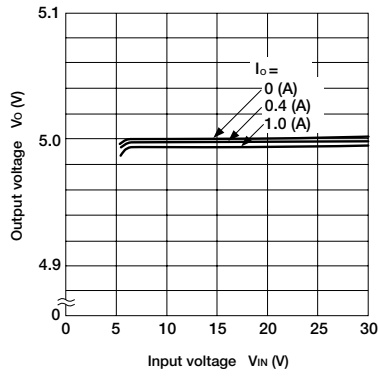

■ Load Regulation

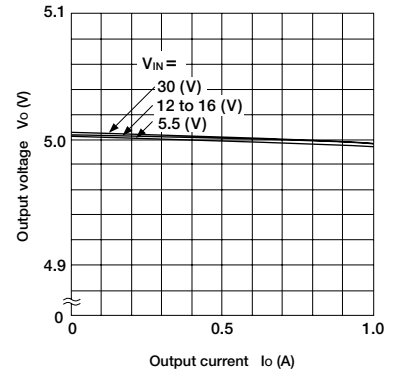

■ Output Voltage Temperature Characteristics

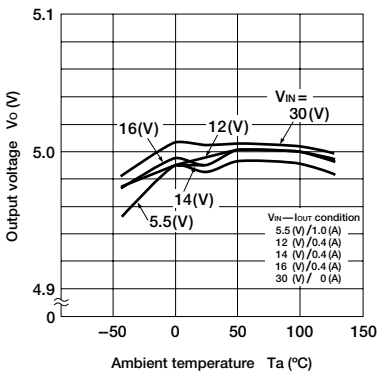

■ Rise Characteristics

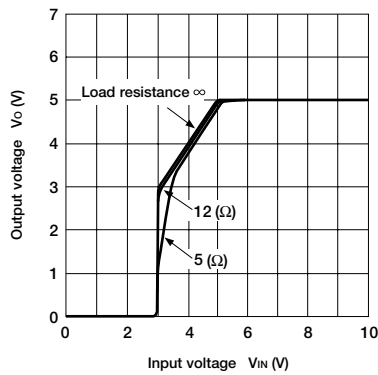

■ Quiescent Circuit Current

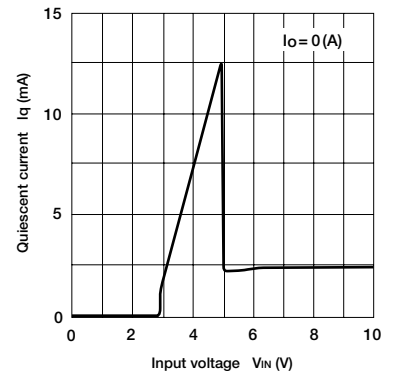

■ ON/OFF Control Characteristics

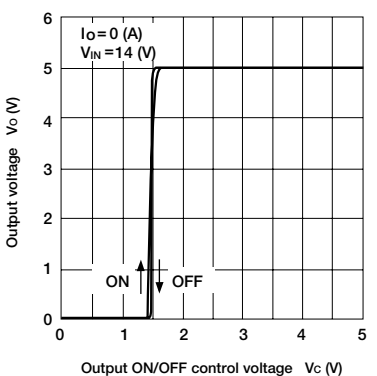

■ Overcurrent Protection Characteristics

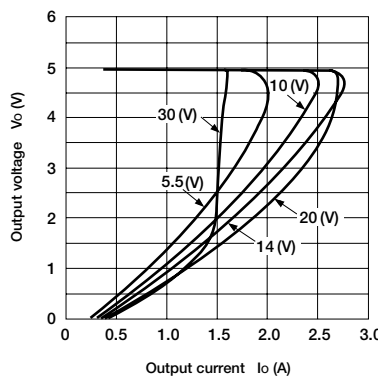

■ Thermal Protection Characteristics

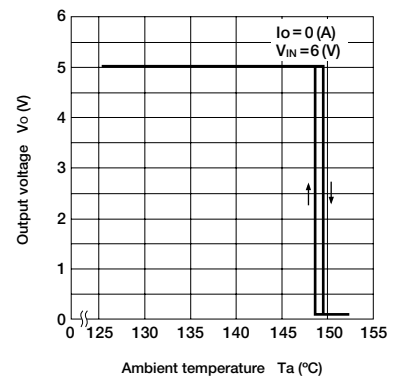

■ Overvoltage Protection Characteristics

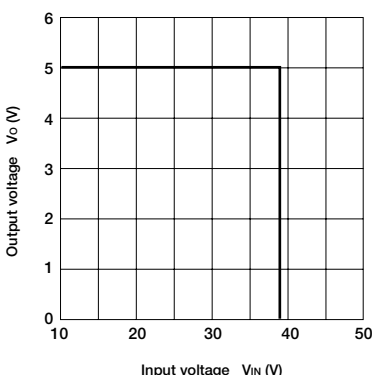

■ T_a — P_D Characteristics

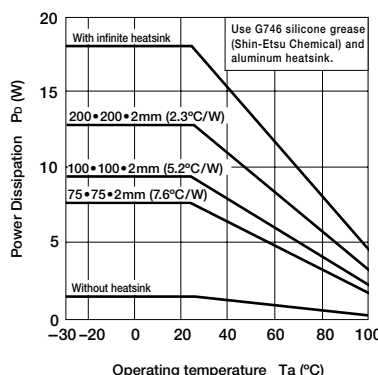

Note on Thermal Protection Characteristics: The thermal protection circuit is intended for protection against heat during instantaneous short-circuiting. Its operation, including reliability, is not guaranteed for short-circuiting over an extended period of time.

Dropper Type Regulator ICs [3-terminal] SI-3003S

Features

- 3-terminal IC regulator with 0.8A output current
- Voltage accuracy of $\pm 2\%$
- Low Dropout voltage $\leq 0.5V$ at $I_O \leq 0.5A$, $\leq 1V$ at $I_O \leq 0.8A$
- Built-in dropping type overcurrent, overvoltage and thermal protection circuits
- TO220 equivalent full-mold package

Absolute Maximum Ratings

($T_a = 25^\circ C$)

Parameter	Symbol	Ratings	Unit	Conditions
DC input voltage	V_{IN}	35	V	
Output current	I_O	0.8 *2	A	
Power Dissipation	P_{D1}	22	W	With infinite heatsink
	P_{D2}	1.8	W	Stand-alone without heatsink
Junction temperature	T_J	-40 to +150	$^\circ C$	
Operating temperature	T_{OP}	-40 to +100	$^\circ C$	
Storage temperature	T_{stg}	-40 to +150	$^\circ C$	
Junction to case thermal resistance	θ_{j-c}	5.5	$^\circ C/W$	
Junction to ambient-air thermal resistance	θ_{j-a}	66.7	$^\circ C/W$	Stand-alone without heatsink

External Dimensions (unit: mm)

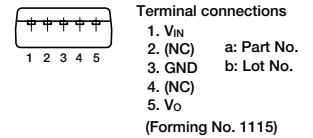
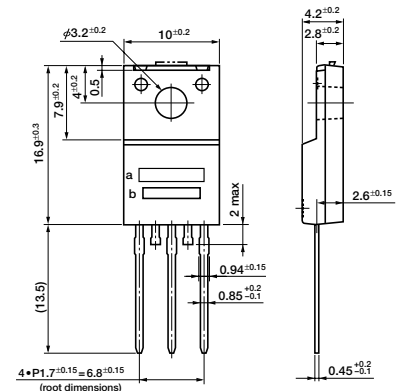

Electrical Characteristics

($T_J = 25^\circ C$, $V_{IN} = 14V$, $I_O = 0.5A$ unless otherwise specified)

Parameter	Symbol	Ratings			Unit	Conditions
		min	typ	max		
Input voltage	V_{IN}	6*2		30*1	V	
Output voltage	V_O	4.90	5.00	5.10	V	
Dropout voltage	V_{DIF}			0.5	V	$I_O \leq 0.5A$
				1.0	V	$I_O \leq 0.8A$
Line regulation	$\Delta V_{O LINE}$			30	mV	$V_{IN} = 8$ to $16V$
Load regulation	$\Delta V_{O LOAD}$			100	mV	$I_O = 0$ to $0.5A$
Ripple rejection	R_{REJ}		54		dB	$f = 100$ to $120Hz$
Quiescent circuit current	I_q		3	10	mA	$I_O = 0A$
Overcurrent protection starting current	I_{S1}	0.9*3			A	

Notes:

- *1. Since $P_{D(max)} = (V_{IN} - V_O) \cdot I_O = 22(W)$, $V_{IN(max)}$ and $I_{O(max)}$ may be limited depending on operating conditions. Refer to the $T_a - P_D$ curve to compute the corresponding values.
 *2. Refer to the dropout voltage.
 *3. I_{S1} rating shall be the point at which the output voltage V_O ($V_{IN} = 14V$, $I_O = 0.5A$) drops to -5% .

Equivalent Circuit Diagram

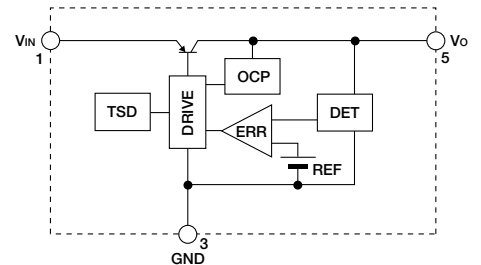

Standard Circuit Diagram

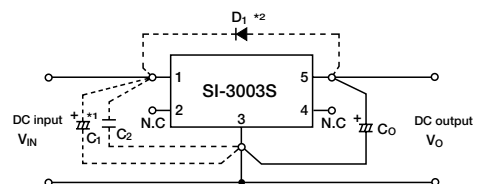

C_O : Output capacitor (47 to 100 μF , 50V)

*1 C_1, C_2 : Input capacitors (C_1 : approx. 47 μF , C_2 : approx. 0.33 μF). These are required for inductive input lines or long wiring. Tantalum capacitors are recommended for C_1 and C_O , especially at low temperatures.

*2 D_1 : Protection diode. Required as protection against reverse biasing between input and output.
(Recommended diode: Sanken EU2Z.)

Electrical Characteristics

■ I_o vs V_{DIF} Characteristics

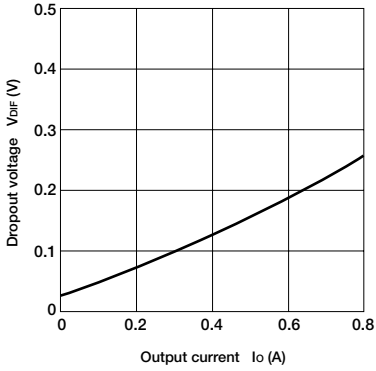

■ Line Regulation

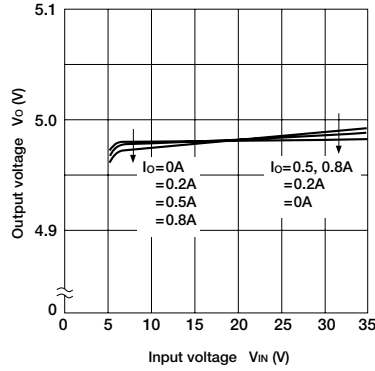

■ Load Regulation

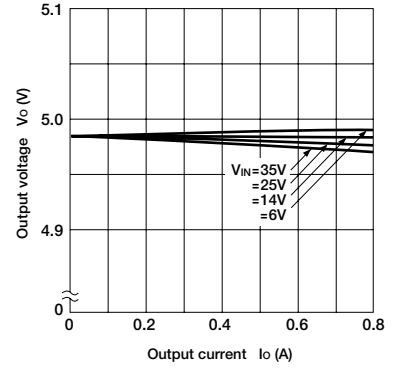

■ Output Voltage Temperature Characteristics

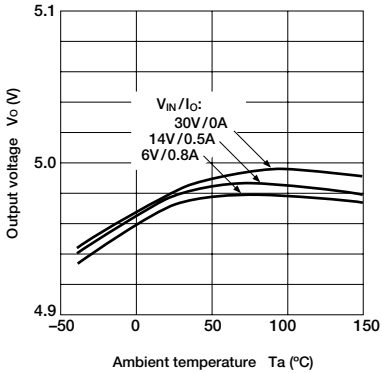

■ Rise Characteristics

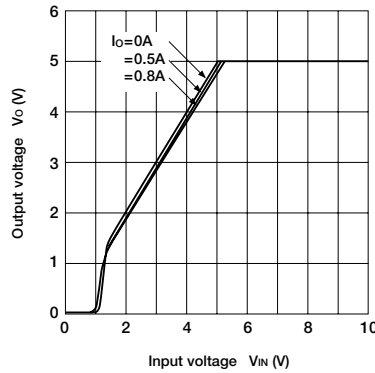

■ Circuit Current

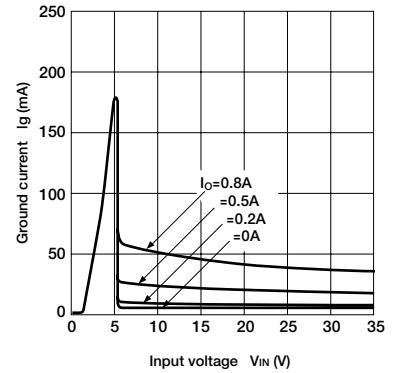

■ Overcurrent Protection Characteristics

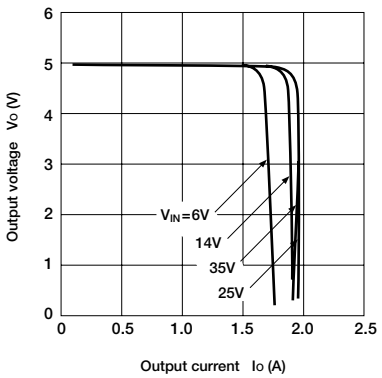

■ Thermal Protection Characteristics

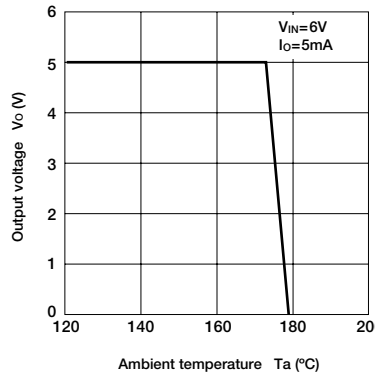

■ T_a — P_D Characteristics

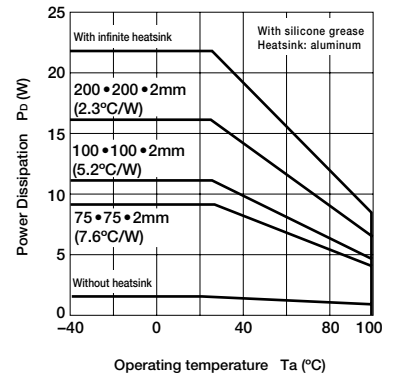

Note on Thermal Protection Characteristics:
The thermal protection circuit is intended for protection against heat during instantaneous short-circuiting. Its operation, including reliability, is not guaranteed for short-circuiting over an extended period of time.

Dropper Type Regulator ICs [2-output] SI-3101S

Features

- Single input dual output <sub output (5V/0.07A), main output (5V/0.4A)>
- Main output can be externally turned ON/OFF (with ignition switch, etc.)
<most suitable as memory backup power supply>
- Low standby current ($\leq 0.8\text{mA}$)
- Low dropout voltage $\leq 1\text{V}$
- Built-in dropping type overcurrent, overvoltage and thermal protection circuits
- TO220 equivalent 5-terminal full-mold package

Absolute Maximum Ratings

($T_a=25^\circ\text{C}$)

Parameter	Symbol	Ratings	Unit	Conditions
DC input voltage	V_{IN}	40	V	
Battery reverse connection	V_{INB}	-13 *6	V	One minute
Output control terminal voltage	V_C	V_{IN}	V	
Output current	CH1	I_{O1}	0.07 *1	A
	CH2	I_{O2}	0.4 *1	A
Power Dissipation	P_{D1}	18	W	With infinite heatsink
	P_{D2}	1.5	W	Stand-alone without heatsink
Junction Temperature	T_J	-40 to +125	$^\circ\text{C}$	
Operating temperature	T_{OP}	-40 to +115	$^\circ\text{C}$	
Storage temperature	T_{stg}	-40 to +125	$^\circ\text{C}$	
Junction to case thermal resistance	θ_{j-c}	5.5	$^\circ\text{C/W}$	
Junction to ambient-air thermal resistance	θ_{j-a}	66.7	$^\circ\text{C/W}$	Stand-alone without heatsink

External Dimensions (unit: mm)

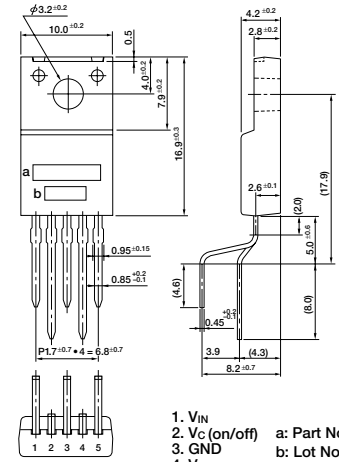

1. V_{IN}
 2. V_C (on/off)
 3. GND
 4. V_{O1}
 5. V_{O2}
- a: Part No.
b: Lot No.
- (Forming No. 1101)

Electrical Characteristics

($T_J=25^\circ\text{C}$, $V_{IN}=14\text{V}$ unless otherwise specified)

Parameter	Symbol	Ratings			Unit	Conditions	
		min	typ	max			
Input voltage	V_{IN}	6 *2		35 *1	V		
Output voltage	CH1	V_{O1}	4.80	5.00	5.20	V	$I_{O1}=0.05\text{A}$
	CH2	V_{O2}	4.80	5.00	5.20	V	$I_{O2}=0.3\text{A}$
Channel-channel voltage difference ($V_{O1}-V_{O2}$)	ΔV_O	-0.1		0.1	V	$I_{O1}=0$ to 0.05A $I_{O2}=0$ to 0.3A	
Dropout voltage	CH1	V_{DIF1}			1.0	V	$I_{O1}\leq 0.05\text{A}$
	CH2	V_{DIF2}			1.0	V	$I_{O2}\leq 0.4\text{A}$
Line regulation	CH1	ΔV_O LINE1	10	30	mV	$V_{IN}=6$ to 18V, $I_{O1}=0.05\text{A}$	
	CH2	ΔV_O LINE2	10	30	mV	$V_{IN}=6$ to 18V, $I_{O2}=0.3\text{A}$	
Load regulation	CH1	ΔV_O LOAD1	30	70	mV	$I_{O1}=0$ to 0.05A	
	CH2	ΔV_O LOAD2	40	70	mV	$I_{O2}=0$ to 0.3A	
Ripple rejection	CH1	R_{REJ1}	54		dB	$f=100$ to 120Hz	
	CH2	R_{REJ2}	54		dB	$f=100$ to 120Hz	
Quiescent circuit current	I_q			0.8	mA	$I_{O1}=0\text{A}$, $V_C=0\text{V}$	
Overcurrent protection starting current	CH1	$I_{(S)1}$	0.1 *3		A		
	CH2	$I_{(S)2}$	0.5 *3		A		
Output control voltage	Output ON	V_{CH}	4.2	4.5	4.8	V	
	Output OFF	V_{CL}	3.2	3.5	3.8	V	
Output control current	Output ON	I_{CH}			100	μA	$V_C=4.8\text{V}$
	Output OFF	I_{CL}	-100			μA	$V_C=3.2\text{V}$
Overvoltage protection starting voltage	V_{OVP}	35 *4			V		
Thermal protection starting temperature	T_{TSD}	130 *5			$^\circ\text{C}$		

Notes:

- *1. Since $P_{D(max)} = (V_{IN} - V_O) \cdot I_{O1} + (V_{IN} - V_{O2}) \cdot I_{O2} = 18$ (W), $V_{IN(max)}$, $I_{O1(max)}$ and $I_{O2(max)}$ may be limited depending on operating conditions. Refer to the T_a-P_D curve to compute the corresponding values.
- *2. Refer to the dropout voltage.
- *3. I_{S1} rating shall be the point at which the output voltage V_{O1} or V_{O2} ($V_{IN}=14\text{V}$, $I_{O1}=0.05\text{A}$ or $I_{O2}=0.3\text{A}$) drops to -5%.
- *4. Overvoltage protection circuit is built only in CH2 (V_{O2} side).
- *5. The indicated temperatures are junction temperatures.
- *6. All terminals, except V_{IN} and GND, are open.

Equivalent Circuit Diagram

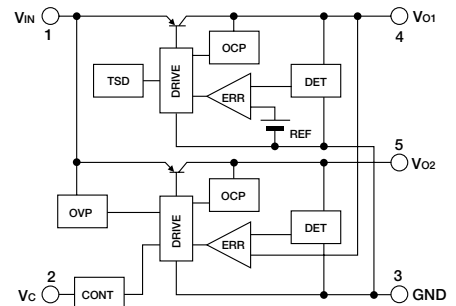

Standard Circuit Diagram

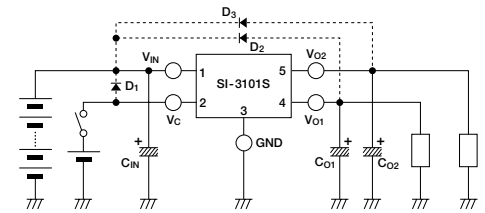

- C_{O1} : Output capacitor (47 to 100 μF , 50V)
 C_{O2} : Output capacitor (47 to 100 μF , 50V)
 C_{IN} : Input capacitors (approx. 47 μF).
 *1 C_{IN} : Tantalum capacitors are recommended for C_{O1} , C_{O2} and C_{IN} , especially at low temperatures.
 *2 D_1 , D_2 , D_3 : Protection diode.
 Required as protection against reverse biasing between input and output.
 (Recommended diode: Sanken EU2Z.)

Electrical Characteristics

Line Regulation (1)

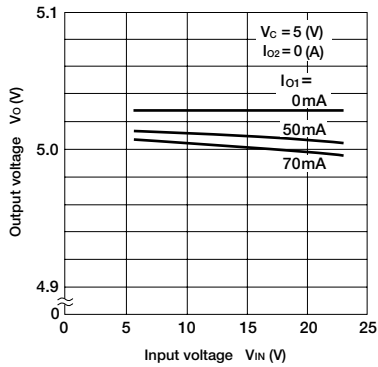

Line Regulation (2)

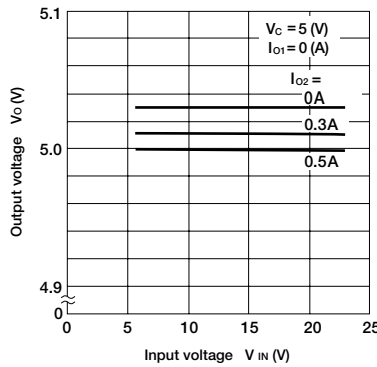

Load Regulation (1)

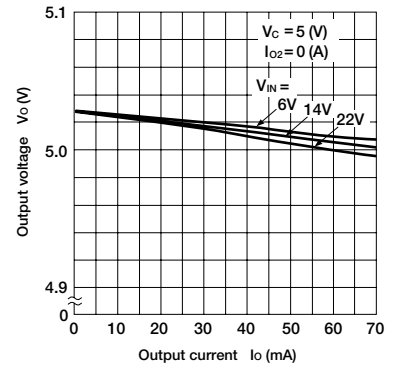

Load Regulation (2)

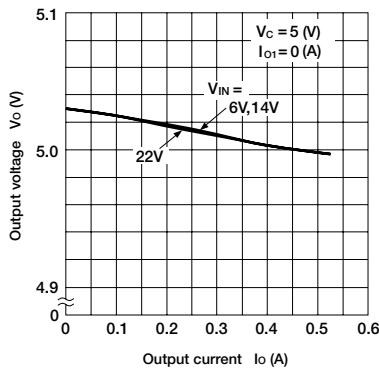

Rise Characteristics

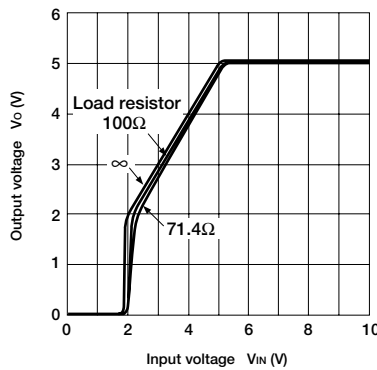

Quiescent Circuit Current

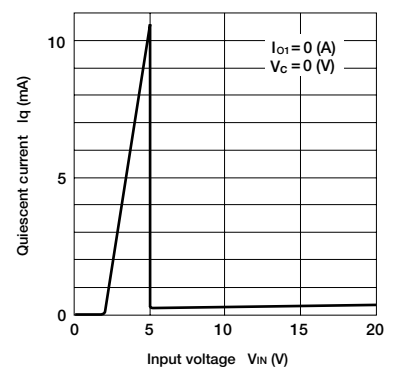

ON/OFF Control Characteristics

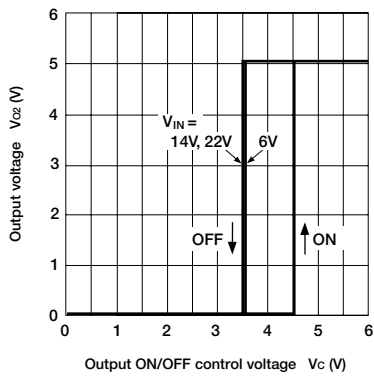

Overcurrent Protection Characteristics (1)

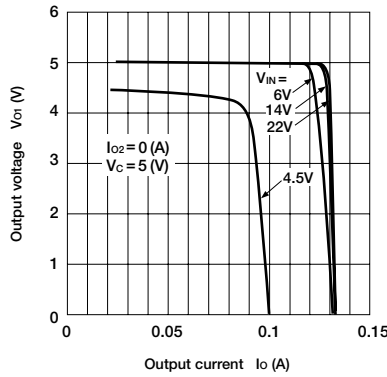

Overcurrent Protection Characteristics (2)

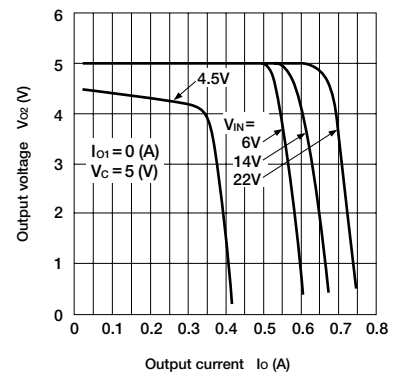

Thermal Protection Characteristics

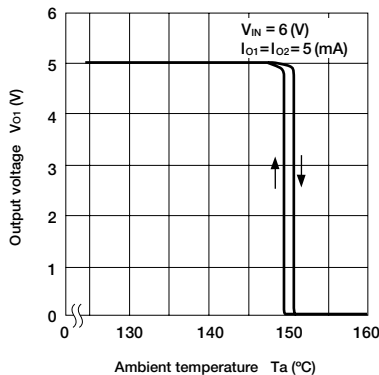

Overvoltage Protection Characteristics

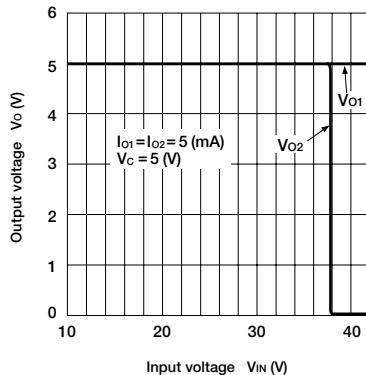

Ta—Pd Characteristics

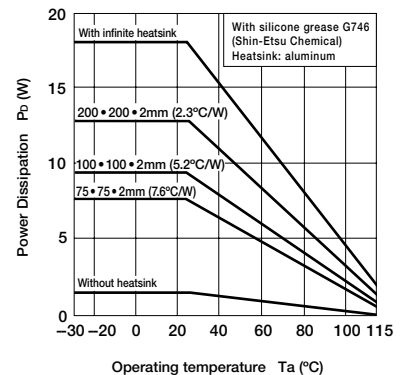

Note on Thermal Protection Characteristics:
The thermal protection circuit is intended for protection against heat during instantaneous short-circuiting. Its operation, including reliability, is not guaranteed for short-circuiting over an extended period of time.

Dropper Type Regulator ICs [2-output] SI-3102S

Features

- Single input dual output <sub output (5V/0.04A), main output (5V/0.1A)>
- Main output can be externally turned ON/OFF (with ignition switch, etc.)
<most suitable as memory backup power supply>
- Low standby current ($\leq 0.8\text{mA}$)
- Low dropout voltage $\leq 1\text{V}$
- Built-in dropping type overcurrent, overvoltage and thermal protection circuits
- TO220 equivalent 5-terminal full-mold miniature package

Absolute Maximum Ratings

($T_a=25^\circ\text{C}$)

Parameter	Symbol	Ratings	Unit	Conditions
DC input voltage	V_{IN}	35	V	
Battery reverse connection	V_{INB}	-13 ^{*6}	V	One minute
Output control terminal voltage	V_C	V_{IN}	V	
Output current	CH1	I_{O1}	0.04 ^{*1}	A
	CH2	I_{O2}	0.1 ^{*1}	A
Power Dissipation	P_{D1}	22	W	With infinite heatsink
	P_{D2}	1.8	W	Stand-alone without heatsink
Junction temperature	T_J	-40 to +150	$^\circ\text{C}$	
Operating temperature	T_{OP}	-40 to +105	$^\circ\text{C}$	
Storage temperature	T_{stg}	-40 to +150	$^\circ\text{C}$	
Junction to case thermal resistance	θ_{j-c}	5.5	$^\circ\text{C}/\text{W}$	
Junction to ambient-air thermal resistance	θ_{j-a}	66.7	$^\circ\text{C}/\text{W}$	Stand-alone without heatsink

Electrical Characteristics

($T_J=25^\circ\text{C}$, $V_{IN}=14\text{V}$ unless otherwise specified)

Parameter	Symbol	Ratings			Unit	Conditions	
		min	typ	max			
Input voltage	V_{IN}	6 ^{*2}		30 ^{*1}	V		
Output voltage	CH1	V_{O1}	4.80	5.00	5.20	V	$I_{O1}=0.04\text{A}$
	CH2	V_{O2}	4.80	5.00	5.20	V	$I_{O2}=0.1\text{A}$
Channel-channel voltage difference ($V_{O1}-V_{O2}$)	ΔV_O	-0.1		0.1	V	$I_{O1}=0$ to 0.04A $I_{O2}=0$ to 0.1A	
Dropout voltage	CH1	V_{DIF1}		1.0	V	$I_{O1}\leq 0.04\text{A}$	
	CH2	V_{DIF2}		1.0	V	$I_{O2}\leq 0.1\text{A}$	
Line regulation	CH1	$\Delta V_{O\text{ LINE1}}$	10	50	mV	$V_{IN}=6$ to 30V, $I_{O1}=0.04\text{A}$	
	CH2	$\Delta V_{O\text{ LINE2}}$	10	50	mV	$V_{IN}=6$ to 30V, $I_{O2}=0.1\text{A}$	
Load regulation	CH1	$\Delta V_{O\text{ LOAD1}}$	30	70	mV	$I_{O1}=0$ to 0.04A	
	CH2	$\Delta V_{O\text{ LOAD2}}$	40	70	mV	$I_{O2}=0$ to 0.1A	
Ripple rejection	CH1	R_{REJ1}	54		dB	$f=100$ to 120Hz	
	CH2	R_{REJ2}	54		dB	$f=100$ to 120Hz	
Quiescent circuit current	I_q			0.8	mA	$I_{O1}=0\text{A}$, $V_C=0\text{V}$	
Overcurrent protection starting current	CH1	$I_{(SI)1}$	0.06 ^{*3}		A		
	CH2	$I_{(SI)2}$	0.15 ^{*3}		A		
Output control voltage	Output ON	V_{CH}	4.2	4.5	4.8	V	
	Output OFF	V_{CL}	3.2	3.5	3.8	V	
Output control current	Output ON	I_{CH}		100	μA	$V_C=4.8\text{V}$	
	Output OFF	I_{CL}	-100		μA	$V_C=3.2\text{V}$	
Overvoltage protection starting voltage	V_{OVP}	30 ^{*4}			V		
Thermal protection starting temperature	T_{TSD}	151 ^{*5}			$^\circ\text{C}$		

Notes:

- *1. Since $P_{D(\text{max})} = (V_{IN} - V_O) \cdot I_{O1} + (V_{IN} - V_{O2}) \cdot I_{O2} = 22\text{ (W)}$, $V_{IN(\text{max})}$, $I_{O1(\text{max})}$ and $I_{O2(\text{max})}$ may be limited depending on operating conditions. Refer to the T_a-P_D curve to compute the corresponding values.
- *2. Refer to the dropout voltage.
- *3. I_{S1} rating shall be the point at which the output voltage V_{O1} or V_{O2} ($V_{IN}=14\text{V}$, $I_{O1}=0.04\text{A}$ or $I_{O2}=0.1\text{A}$) drops to -5%.
- *4. Overvoltage protection circuit is built only in CH2 (V_{O2} side).
- *5. The indicated temperatures are junction temperatures.
- *6. All terminals, except V_{IN} and GND, are open.

External Dimensions (unit: mm)

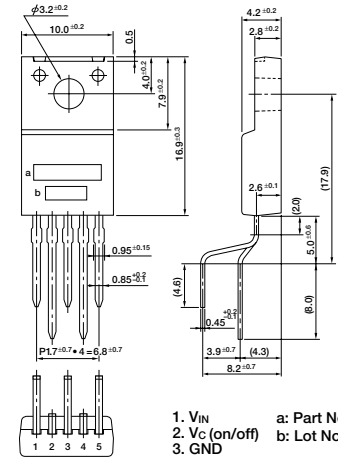

1. V_{IN} a: Part No.
2. V_C (on/off) b: Lot No.
3. GND
4. V_{O1}
5. V_{O2}
(Forming No. 1101)

Equivalent Circuit Diagram

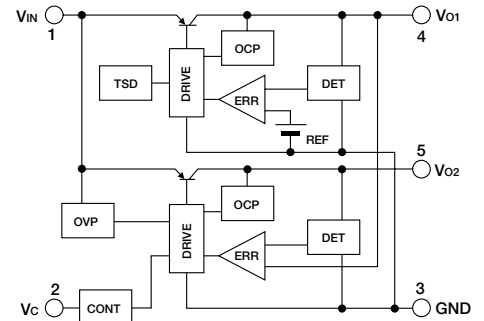

Standard Circuit Diagram

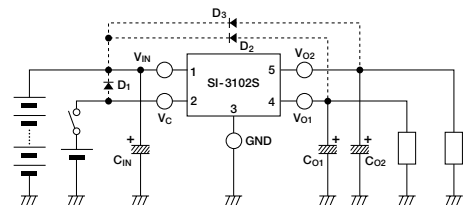

- C_{O1} : Output capacitor (47 to 100 μF , 50V)
 C_{O2} : Output capacitor (47 to 100 μF , 50V)
 C_{IN} : Input capacitors (approx. 47 μF).
 Tantalum capacitors are recommended, for C_{O1} , C_{O2} and C_{IN} , especially at low temperatures.
 D_1, D_2, D_3 : Protection diode.
 Required as protection against reverse biasing between input and output.
 (Recommended diode: Sanken EU2Z.)

Electrical Characteristics

Line Regulation (1)

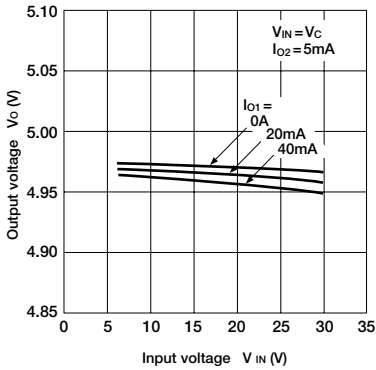

Line Regulation (2)

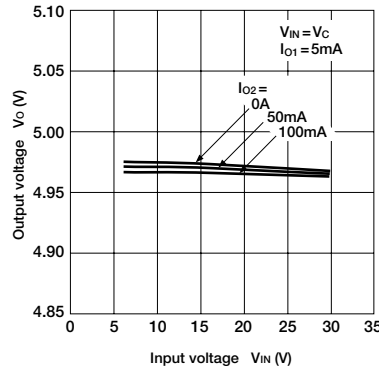

Load Regulation (1)

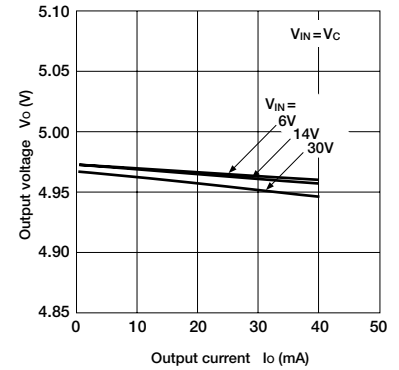

Load Regulation (2)

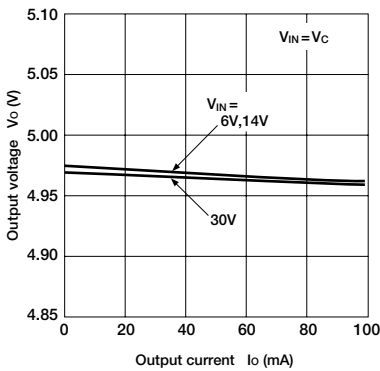

Rise Characteristics

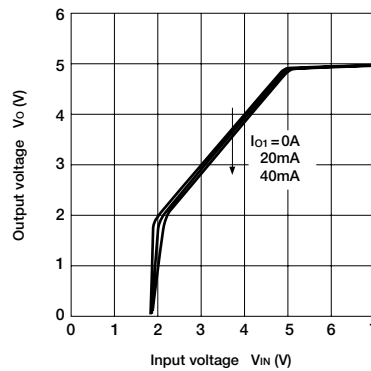

Quiescent Circuit Current

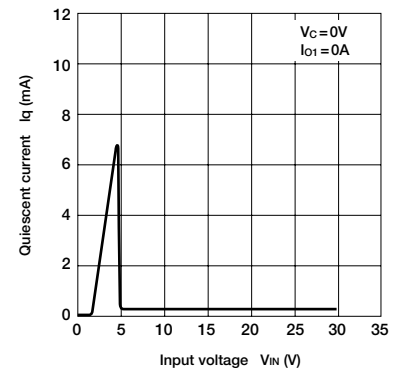

ON/OFF Control Characteristics

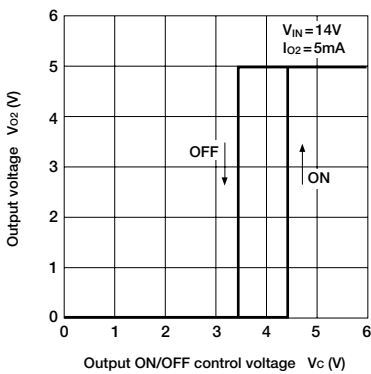

Overcurrent Protection Characteristics (1)

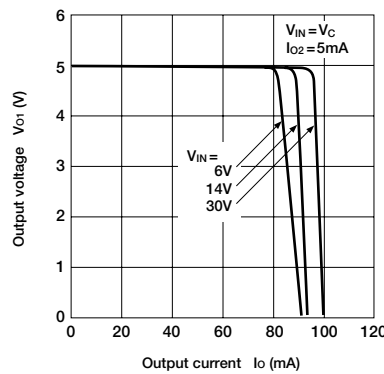

Overcurrent Protection Characteristics (2)

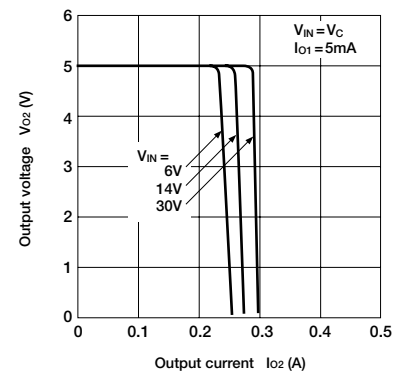

Thermal Protection Characteristics

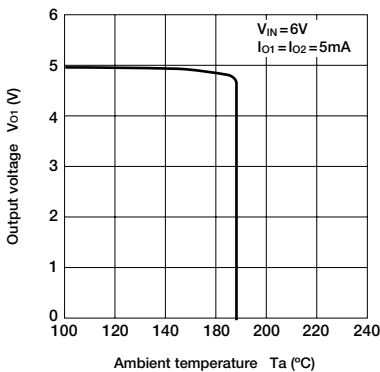

Overvoltage Protection Characteristics

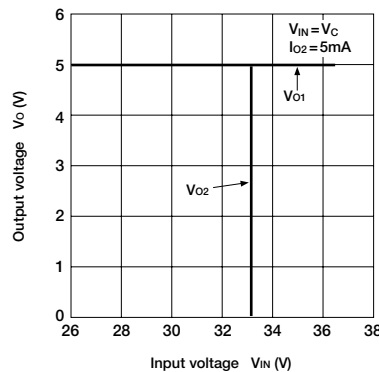

Ta—Pd Characteristics

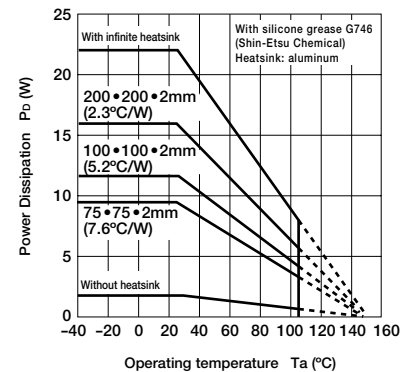

Note on Thermal Protection Characteristics:
The thermal protection circuit is intended for protection against heat during instantaneous short-circuiting. Its operation, including reliability, is not guaranteed for short-circuiting over an extended period of time.

Dropper Type System Regulator ICs SI-3322S

Features

- High accuracy output of $5V \pm 30mV$
- Memory backup power supply $4V \pm 0.2V$
- Power on reset function
- Supply voltage monitor function
- Watch dog timer
- CR not required for setting external time constant

Absolute Maximum Ratings

Parameter	Symbol	Applicable terminals	Ratings	Unit	Conditions
Terminal voltage	V_{IN} (1)	BAI, V_{CC} , V_{NMIC}	-0.3 to 32	V	
		V_S , $NMIC$, $RSTTC$, $OUTE$			
	V_{IN} (2)	V_{SC} , NMI , $RESET$, $OUTE$ W/D, $STBY$	-0.3 to 7	V	
Storage temperature	Tstg	—	-40 to +125	°C	
Operating temperature	Top	—	-40 to +105	°C	
Power dissipation	P_D	—	1.4	W	$T_a = 25^\circ C$

Electrical Characteristics

($T_a = 25^\circ C$ unless otherwise specified)

Parameter	Symbol	Ratings			Unit	Conditions	
		min	typ	max			
V_{SC} output voltage	V_{SC}	3.8	4	4.2	V	$BAI = 4.2$ to $16V$, $I_{SC} = -0.2mA$	
V_S output voltage	V_S	4.97	5	5.03	V	$V_{CC} = 5.2$ to $16V$, $I_o = -350mA$	
$V_S - V_{SC}$ voltage difference	ΔV_S			0.3	V	$V_{CC} = 5.2V$, $I_{SC} = -50mA$	
BAI input current	I_{BAI}			0.6	mA	$BAI = 4.9$ to $16V$, $I_{SC} = -0.2mA$	
V_{CC} input current	I_{CC}			5	mA	$V_{CC} = 3$ to $16V$	
V_B input current	I_B			25	mA	$V_{CC} = 3$ to $16V$	
V_S input current	I_S			20	mA	$V_{CC} = BAI = 3$ to $16V$, $I_{SC} = 0mA$	
$NMIC$ input current	I_{NMIC}	-0.04	-0.1	-0.4	mA	$V_{CC} = BAI = 14V$	
W/D input current	$I_{W/D}$	-0.04	-0.1	-0.4	mA	$V_{CC} = BAI = 14V$	
RSTTC input current	I_{RSTTC}	-0.04	-0.1	-0.4	mA	$V_{CC} = BAI = 14V$	
\overline{NMI} judge voltage	Lo	V_{NIL}	4.9	5	5.1	V	$NMIC = 0V$
	Hysteresis	ΔV_N	0.12		0.3	V	
\overline{NMI} output voltage	Hi	V_{NOH}	$V_S - 0.5$			V	$I_{source} = -1mA$
	Lo	V_{NOL}			0.6	V	$I_{sink} = 0.5mA$
$STBY$ output voltage	Hi	V_{SOH}	$V_S - 0.5$			V	$I_{source} = -1mA$
	Lo	V_{SOL}			0.6	V	$I_{sink} = 0.5mA$
$RESET$ output voltage	Hi	V_{ROH}	$V_S - 0.5$			V	$I_{source} = -1mA$
	Lo	V_{ROL}			0.6	V	$I_{sink} = 0.5mA$
$OUTE$ output voltage	Hi	V_{UOH}	$V_S - 0.5$			V	$I_{source} = -1mA$
	Lo	V_{UOL}			0.6	V	$I_{sink} = 0.5mA$
$OUTE$ output voltage	Hi	V_{TOH}	$V_S - 0.5$			V	$I_{source} = -1mA$
	Lo	V_{TOL}			0.6	V	$I_{sink} = 0.5mA$
Standby release time	T_{ST}	5	10	20	ms		
Reset release time	T_{RE}	60	75	90	ms		
Reset cycle	T_{RC}	40	50	60	ms		
Reset period	T_{RP}	20	25	30	ms		
W/D signal stop detect period	T_{WS}	10	12.5	15	ms		
Reset signal output time	T_{NR}	80			μs		
Standby signal output time	T_{RS}	10			μs		
W/D fail judge frequency	F_{FH}	2		5	kHz		
Out enable release time	T_{WE}	40	50	10	ms		

Notes: The direction of current flowing into the IC is positive (+).

External Dimensions (unit: mm)

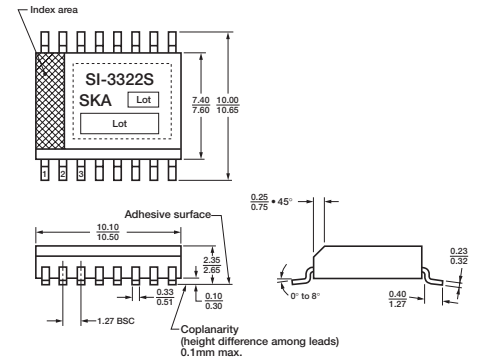

Standard Connection Diagram

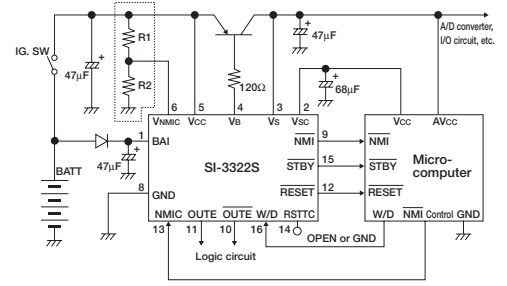

R1, R2: \overline{NMI} judge voltage (5V typ) variable resistor
 \overline{NMI} judge voltage $\approx (R1 + R2) \cdot 2.5V/R2$
 R1, R2 $\approx 2k$
 Normally, V_{NMIC} terminal is open.
 RSTTC: Normally open.
 GND connected when TRE is to be halved.

Circuit Block Diagram

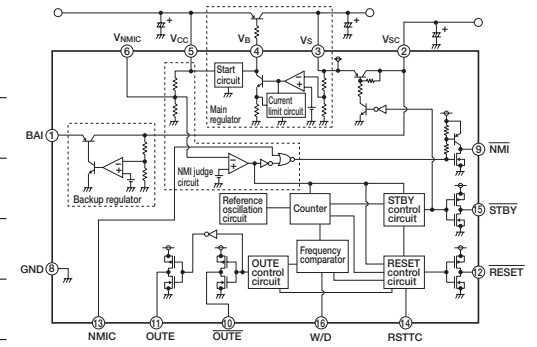

Timing Chart

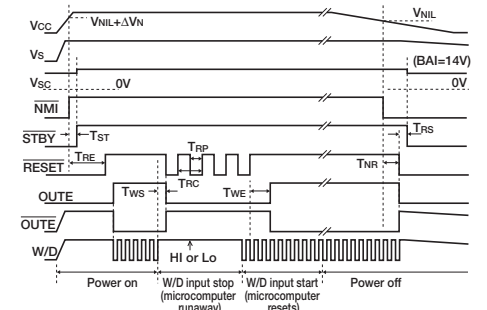

Electrical Characteristics

■ V_S Line Regulation

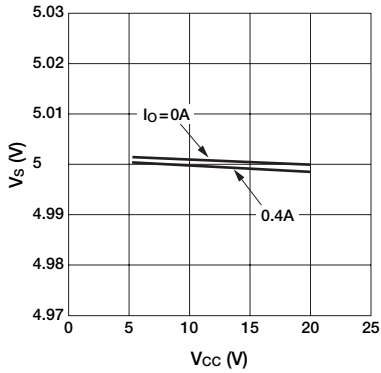

■ V_S Load Regulation

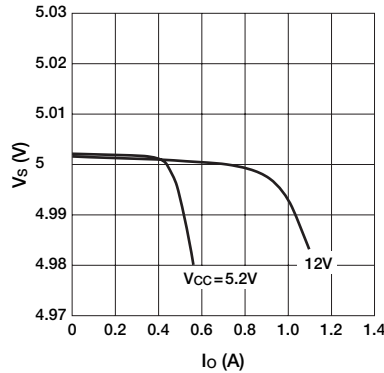

■ V_S Rise Characteristics

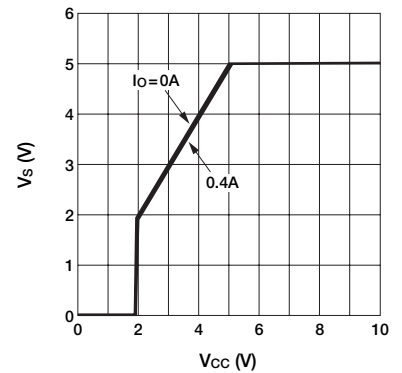

■ V_S Overcurrent Protection Characteristics

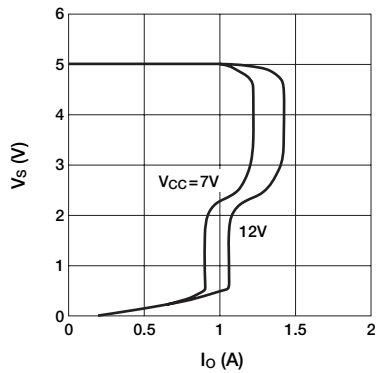

■ V_{CC} Input Current

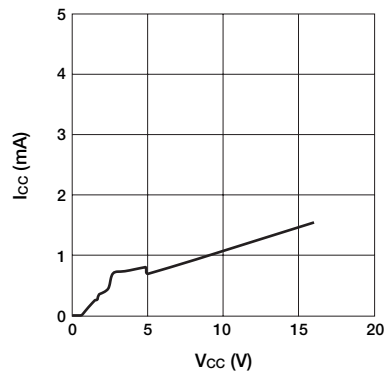

■ V_S Input Current

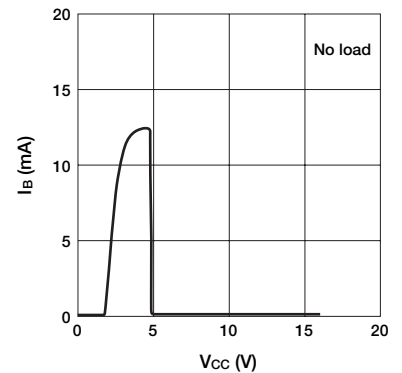

■ V_S Input Current

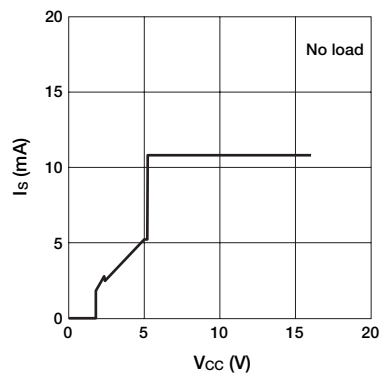

■ V_{SC} Rise Characteristics

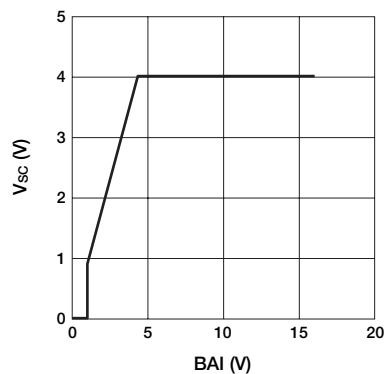

■ V_{SC} Overcurrent Protection Characteristics

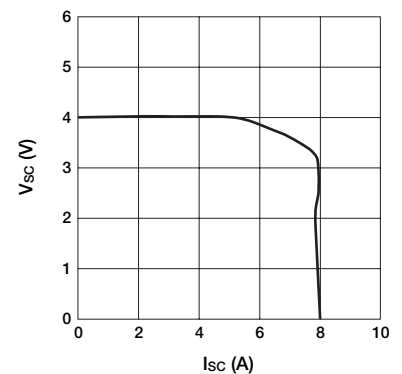

■ B_{AI} Input Current

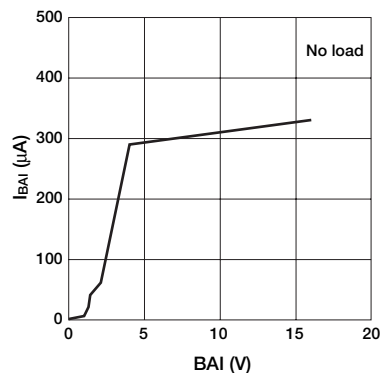

■ V_S - V_{SC} Voltage Difference

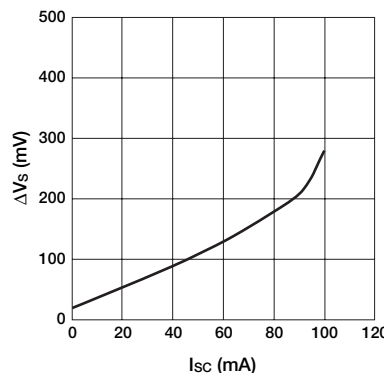

■ \overline{NMI} Judge Voltage Characteristics

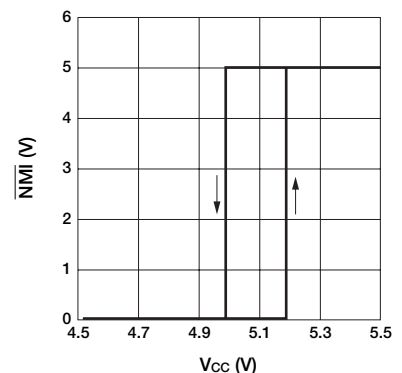

Dropper Type System Regulator ICs [Surface-mount 2-output] **SPF3004**

Features

- Single input dual output (ch1: 5V/0.4A, ch2: 3.3V/0.2A)
- Power on reset function
- Watchdog timer
- Built-in drooping type overcurrent and thermal protection circuits (ch1)

Absolute Maximum Ratings

(Ta=25°C)

Parameter	Symbol	Ratings	Unit	Remarks
DC input voltage	VIN	-13 to 35	V	Reverse connection 1 min max. <400mS
		40		
Output control terminal voltage	EN	-0.3 to 35	V	<400mS
		40		
Output current	CH1	Io1	A	
	CH2	Io2		
MODE terminal input voltage	MODE			
W/D/C terminal input voltage	W/D/C			
TC terminal input voltage	TC			
CK terminal input voltage	CK	-0.3 to 7	V	
Vo1-fail terminal output voltage	Vo1-fail			
Reset terminal output voltage	RESET			
Junction temperature	Tj	-40 to 150	°C	
Storage temperature	Tstg	-40 to 150	°C	
Thermal resistance (junction to case)	θj-c	4.1	°C/W	With infinite heatsink
Thermal resistance (junction to ambient air)	θj-a	38	°C/W	With glass epoxy + copper foil board (size 5.0 x 7.4cm; t: glass epoxy = 1.6mm/copper foil = 18μm)

Electrical Characteristics

Parameter	Symbol	Ratings			Unit	Conditions	
		min	typ	max			
Input voltage	VIN	Vo1+VDF1 *3		35 *4	V		
Output voltage	CH1	Vo1	4.90	5.00	5.10	V	VIN = Vo1 + VDF1 to 18V, Io1 = 0 to 0.4A, Tj = -40 to 125°C
	CH1	Vo1	4.85	5.00	5.15	V	VIN = Vo1 + VDF1 to 18V, Io1 = 0 to 0.4A, Tj = -40 to 150°C
	CH2	Vo2	3.15	3.30	3.45	V	VIN = Vo2 + VDF1 + VDF2 to 18V, Io1 = 0 to 0.2A
Dropout voltage	CH1	VDF11			0.5	V	Io1 = 0.4A
	CH1	VDF12			0.25	V	Io1 = 0.2A, Tj = 25°C
Ripple rejection	CH1	RREJ1		54		db	Io2 = 0.2A
	CH2	RREJ2		54			
Quiescent circuit current	Iq		10	50		μA	VIN = 16V, EN = 0V
			50	250		mA	VIN = 35V, EN = 0V
GND current	IGND		70	100		mA	Io1 = Io2 = 0.2A
Overcurrent protection starting current	CH1	Is11	0.402		1.80	A	Vo1 = 4.5V
	CH2	Is21	0.201		0.80	A	Vo2 = 2.8V
Residual current at a short	CH1	Is21	0.402		1.80	A	Vo1 = 0V
	CH2	Is22	0.201		0.80	A	Vo2 = 0V
EN output control voltage	VENth		1.0		3.5	V	Tj = -40 to 125°C
			0.9		3.5	V	*8
EN output control current	ON	LENH1			50	μA	EN = 6.4V, Tj = -40 to 125°C
		LENH2			30	μA	EN = 3.51V, Tj = -40 to 125°C
		LENL	-1.0		1.0	μA	EN = 0V, Tj = -40 to 125°C
Vo1-fail terminal LOW voltage	VfailL				0.5	V	Isink = 250μA, (Pull-up resistance 20kΩ typ)
Vo1-fail terminal HI voltage	VfailH	Vo1-0.8V *5				V	Isource = 15μA
Reset terminal LOW voltage	VrsL				0.5	V	Isink = 250μA, (Pull-up resistance 20kΩ typ)
Reset terminal HI voltage	VrsH	Vo1-0.8V *5				V	Isource = 15μA
Reset detect voltage	CH1	Vo1thH			Vo1 • 0.97	V	
		Vo1thL	4.05			V	Vrs, Vfail > 4.5V
	Vo2thH				Vo2 • 0.985	V	Vrs > 3.0V
	Vo2thL	3.00				V	Vrs < 0.8V
Reset detect voltage hysteresis width	CH1	ΔVo1th			0.255	V	ΔVo1th = Vo1thH - Vo1thL
	CH2	ΔVo2th			0.105	V	ΔVo2th = Vo2thH - Vo2thL
Power on reset delay time	tdly	0.70 • Rtc • Ctc	0.72 • Rtc • Ctc	0.74 • Rtc • Ctc		S	Min. set time: 6mS
W/D time	twd	0.52 • Rtc • Ctc	0.54 • Rtc • Ctc	0.56 • Rtc • Ctc		S	Min. set time: 4mS
W/D pulse time	twdp	0.04 • Rtc • Ctc	0.06 • Rtc • Ctc	0.08 • Rtc • Ctc		S	Min. set time: 400μS
MODE terminal control voltage	Vmodeth	1.0			3.0	V	
MODE terminal control current	ON	ImodeH			200	μA	MODE = 5V
	OFF	ImodeL	-1.0		1.0	μA	MODE = 0V, Tj = -40 to 125°C
W/D/C terminal control voltage	Vw/d/cth	1.0			3.0	V	*7
W/D/C terminal control current	ON	Iw/d/cl			200	μA	W/D/C = 5V
	OFF	Iw/d/cl	-1.0		1.0	μA	W/D/C = 0V, Tj = -40 to 125°C
CK terminal control voltage	Vckth	1.0			3.0	V	Min. clock pulse time = 5μS (Duty 50%)
CK terminal control current	ON	IckH			200	μA	CK = 5V
	OFF	IckL	-1.0		1.0	μA	CK = 0V, Tj = -40 to 125°C

Notes:

- *3: Refer to dropout voltage.
- *4: Since $P_{D(max)} = \{(V_{IN}-V_{O1}) \cdot (Io1 + Io2)\} + (V_{IN} \cdot Iq) + \{(V_{O1}-V_{O2}) \cdot Io2\} = 30W$, $V_{IN(max)}$, $Io1(max)$ and $Io2(max)$ may be limited depending on operating conditions.
- *5: The Vo1-fail and RESET terminals are pulled up in the IC; may be directly connected to logic circuits.
- *6: The thermal protection function is built in Vo1 (CH1 side) only. The design thermal protection starting temperature is 155°C (min.) and 165°C (typ). These values represent the design warranty.
- *7: The threshold voltage at the W/D/C terminals is determined by the presence/absence of WD operation (occurrence of RESET signal pulses). The W/D/C function is assumed to be OFF during the period when RESET pulses occur.
- *8: The TOFF-EN operation (VEN: 5V→0V) for Tj=150°C is 16mS (0.32V/mS) max.

External Dimensions (unit: mm)

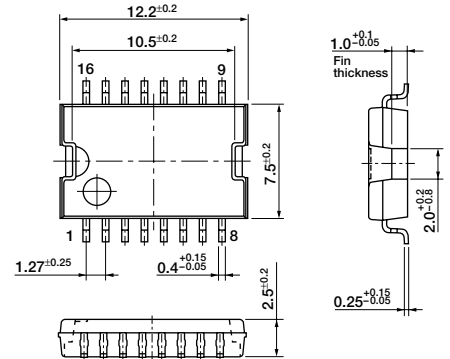

Standard Connection Diagram

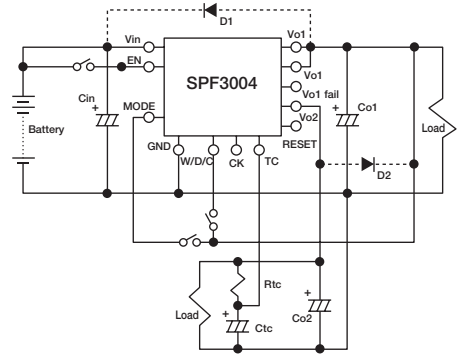

- Cin: Capacitor (39μF) for oscillation prevention
 Co1: Output capacitor (39μF)
 Co2: Output capacitor (39μF)
 Tantalum capacitors are recommended especially for low temperatures.
 D1, D2: Protection diodes.
 Required as protection against reverse biasing between input and output (Recommended diode: SANKEN EU2Z).

Timing Chart

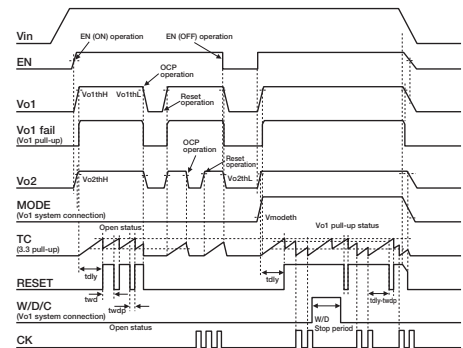

Electrical Characteristics

■ Rise Characteristics of Output Voltage

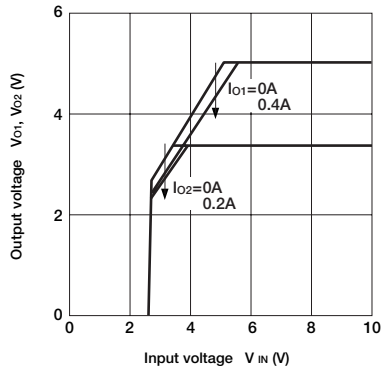

■ Line Regulation (V01)

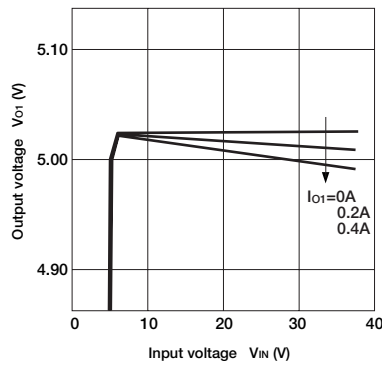

■ Line Regulation (V02)

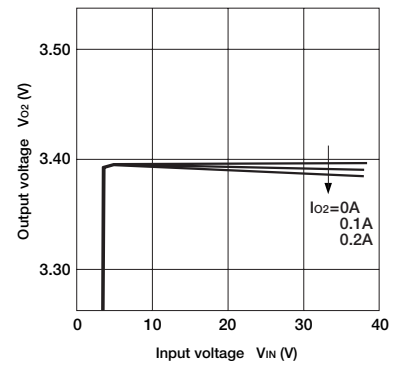

■ Load Regulation (V01)

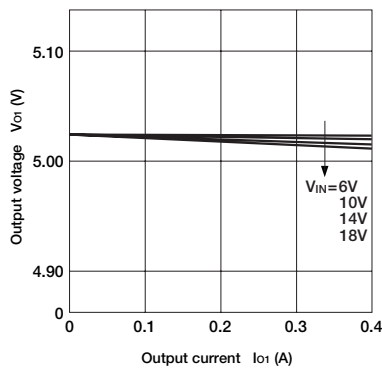

■ Load Regulation (V02)

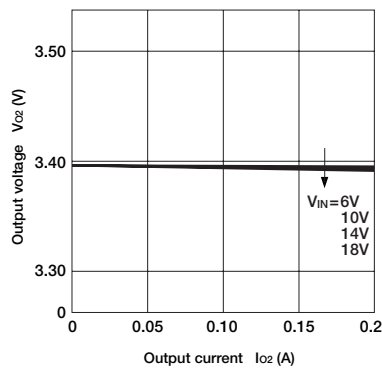

■ Dropout Voltage (V01)

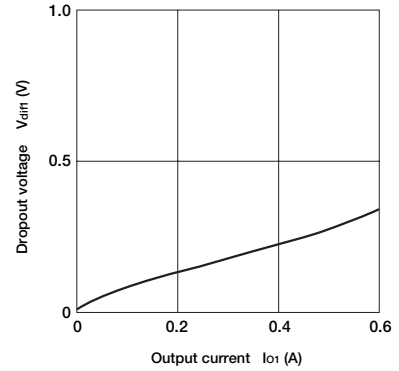

■ GND Current

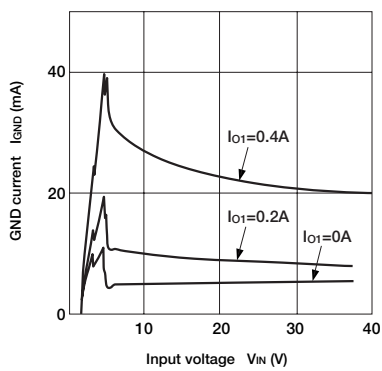

■ Overcurrent Protection Characteristics (V01)

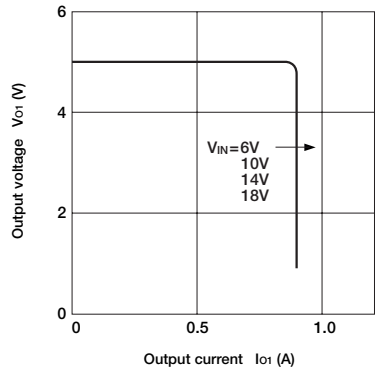

■ Overcurrent Protection Characteristics (V02)

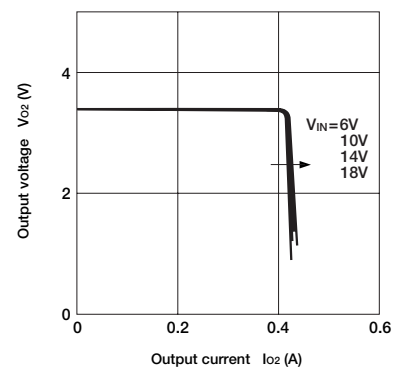

■ Thermal Protection Characteristics

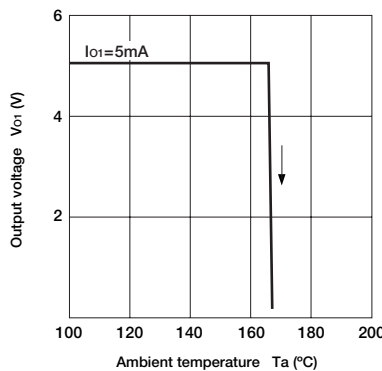

■ EN Terminal Output Voltage

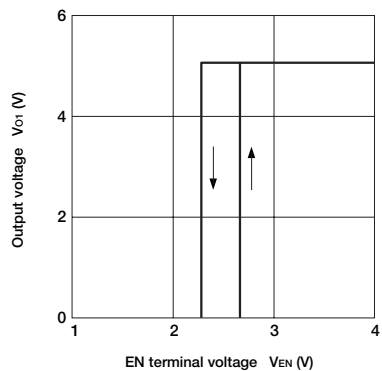

■ Ta—Pd Characteristics

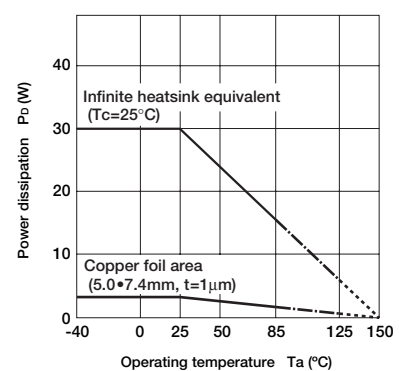

Dropper Type System Regulator ICs [Surface-mount 2-output] **SPF3006**

Features

- Dual input and dual output (ch1: 5V/0.4A, ch2: 5V/0.2A)
- Power on reset function
- Watchdog timer
- Built-in drooping type overcurrent and thermal protection circuits (ch1)

Absolute Maximum Ratings

(T_a=25°C)

Parameter	Symbol	Ratings	Unit	Remarks
DC input voltage	V _{IN1}	-13 to 35	V	Reverse connection 1 min max.
	V _{IN2}			
Vo1, Vo2 output control terminal voltage	EN	-0.3 to 35	V	
Vo2 output control terminal voltage	VC	-0.3 to 35	V	
Output current	CH1	I _{o1}	0.4	A
	CH2	I _{o2}	0.2	A
TC terminal input voltage	TC	-0.3 to 7	V	
CK terminal input voltage	CK			
W/D/C terminal input voltage	W/D/C			
Reset terminal output voltage	RESET			
Power dissipation	P _{D1}	18.6	W	With an infinite heatsink mounted. *1
	P _{D2}	2.97		
Junction temperature	T _J	-40 to 150	°C	
Operating temperature	T _{op}	-40 to 105	°C	
Storage temperature	T _{stg}	-40 to 150	°C	
Thermal resistance (junction to case)	θ _{J-C}	6.7	°C/W	With an infinite heatsink mounted.
Thermal resistance (junction to ambient air)	θ _{J-A}	42	°C/W	*1

Notes: *1: With glass epoxy + copper foil board (size 5.0 × 7.4cm; t: glass epoxy = 1.6mm / copper foil = 18μm)

Electrical Characteristics

Parameter	Symbol	Ratings			Unit	Conditions		
		min	typ	max				
Input voltage	V _{IN1, 2}	Vo1+V _{DIF1}		35	V	*2, 3		
Output voltage	CH1	Vo1	4.85	5.00	5.15	V	V _{IN1} =6 to 18V, I _o =0 to 0.3A	
	CH2	Vo2	4.85	5.00	5.15	V	V _{IN2} =6 to 18V, I _o =0 to 0.3A	
Dropout voltage	CH1	V _{DIF1}			0.5	V		
	CH2	V _{DIF2}			0.5	V		
Ripple rejection	CH1	R _{REJ1}		54		db	f = 100 to 120Hz	
	CH2	R _{REJ2}		54				
Quiescent circuit current	I _q		10	50		μA	V _{IN1} =16V, V _{EN} =0V	
			50	250				V _{IN1} =35V, V _{EN} =0V
			5	10				
GND current	I _{GND}		70	100		mA	I _{o1} =I _{o2} =0.2A	
Overcurrent protection starting current	CH1	I _{s11}	0.402		1.8	A	Vo1=4.5V	
	CH2	I _{s21}	0.201		0.8	A	Vo2=4.5V	
Residual current at a short	CH1	I _{s21}	0.402		1.8	A	Vo1=0V	
	CH2	I _{s22}	0.201		0.8	A	Vo2=0V	
EN output control voltage	V _{ENth}		0.9		3.5	V		
EN output control current	ON	I _{ENH}			50	μA	EN=5V	
	OFF	I _{ENL}	-1.0		1.0	μA	EN=0V	
Reset terminal LOW voltage	V _{rSL}				0.5	V	I _{sink} =250μA (Pull-up resistance 20kΩ typ)	
Reset terminal HI voltage	V _{rSH}	Vo1-0.8V				V	I _{source} =15μA *4	
Reset detect voltage	CH	Vo1thH			Vo1+0.97	V	V _{rS} >4.5V	
		Vo1thL	4.05			V	V _{rS} <0.8V	
Power on reset delay time	t _{dly}	1.18 • R _{tc} • C _{tc}	1.26 • R _{tc} • C _{tc}	1.35 • R _{tc} • C _{tc}		S	Min. set time: 6mS	
W/D time	t _{wd}	0.93 • R _{tc} • C _{tc}	1.03 • R _{tc} • C _{tc}	1.13 • R _{tc} • C _{tc}		S	Min. set time: 4mS	
W/D pulse time	t _{wdp}	0.07 • R _{tc} • C _{tc}	0.13 • R _{tc} • C _{tc}	0.19 • R _{tc} • C _{tc}		S	Min. set time: 400μS	
CK terminal control voltage	V _{ckth}		1.0		3.0	V	Min. clock pulse time: 5μs (Duty 50%)	
CK terminal control current	ON	I _{ckH}			200	μA	V _{ck} =5V	
	OFF	I _{ckL}	-1.0		1.0	μA	V _{ck} =0V	
Vc output control voltage	V _{cth}		1.0		3.5	V		
Vc output control current	I _{ch}				300	μA	V _c =5V	
	I _{cl}		-1.0		1.0	μA	V _c =0V	
W/D/C terminal control voltage	V _{w/d/cth}		1.0		3.0	V		
W/D/C terminal control current	ON	I _{w/d/ch}			200	μA	V _{w/d/c} =5V	
	OFF	I _{w/d/cl}	-1.0		1.0	μA	V _{w/d/c} =0V	

Notes:

*2: Refer to Dropout Voltage.

*3: Since P_{D(max)} = (V_{IN}-V_{O1}) • I_{o1} + (V_{IN2}-V_{O2}) • I_{o2} + (V_{IN} • I_q) = 22W, V_{IN(max)}, I_{o1(max)} and I_{o2(max)} may be limited depending on operating conditions.

*4: The RESET terminal is pulled up in the IC; may be directly connected to logic circuits.

*6: The thermal protection function is built in V_{O1} (CH1 side) only. The design thermal protection starting temperature is 151°C (min.) and 165°C (typ). These values represent the design warranty.

External Dimensions (unit: mm)

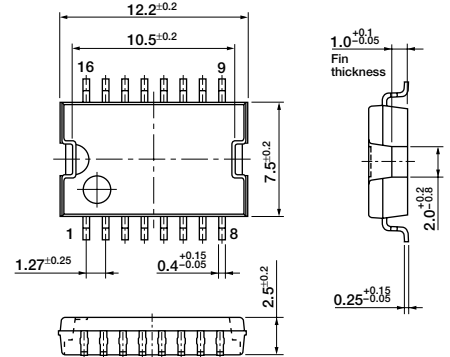

Standard Connection Diagram

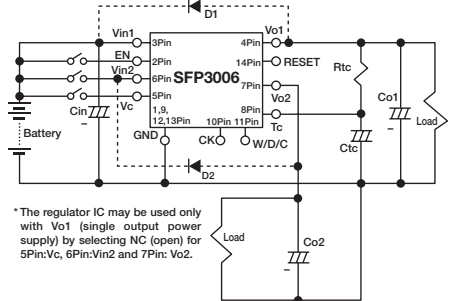

* The regulator IC may be used only with Vo1 (single output power supply) by selecting NC (open) for 5Pin:Vc, 6Pin:Vin2 and 7Pin:Vo2.

Cin: Capacitor (39μF) for oscillation prevention
Co1: Output capacitor (39μF)
Co2: Output capacitor (39μF)

Tantalum capacitors are recommended particularly for low temperatures (tantalum capacitors of about 0.47μF in parallel).
D1, D2: Protection diodes.
Required for protection against reverse biasing between input and output (Recommended diode: SANKEN EU2Z).

Circuit Block Diagram

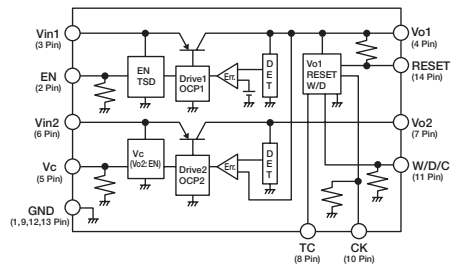

Timing Chart

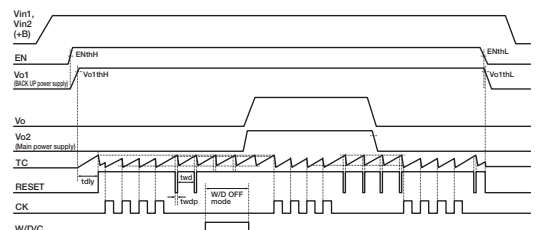

Electrical Characteristics

■ Rise Characteristics of Output Voltage (V_{O1})

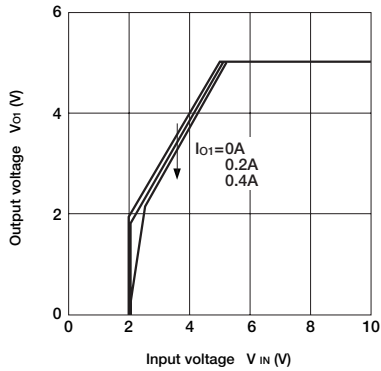

■ Rise Characteristics of Output Voltage (V_{O2})

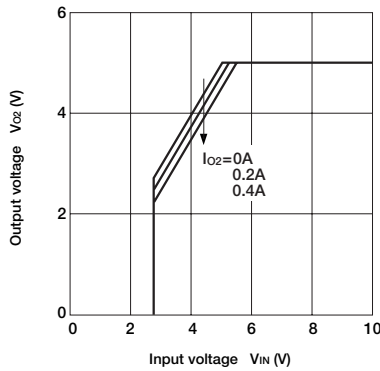

■ Line Regulation (V_{O1})

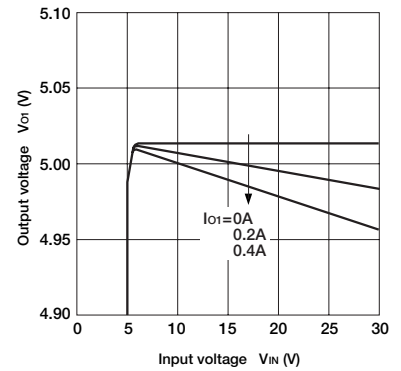

■ Line Regulation (V_{O2})

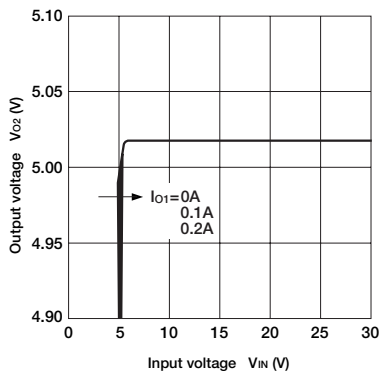

■ Load Regulation (V_{O1})

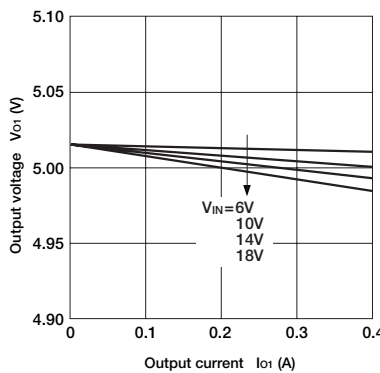

■ Load Regulation (V_{O2})

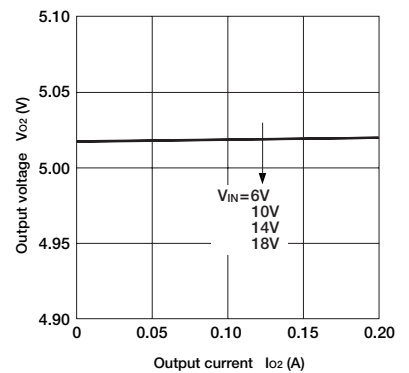

■ Dropout Voltage (V_{O1})

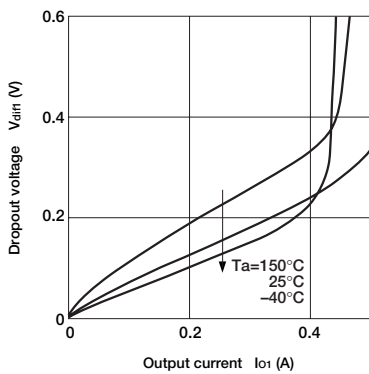

■ Dropout Voltage (V_{O2})

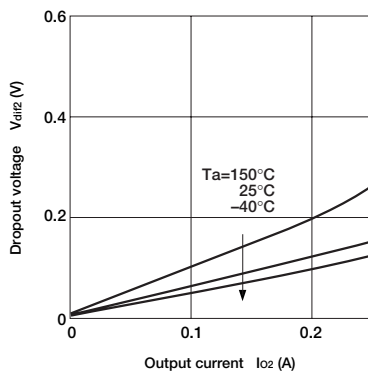

■ Overcurrent Protection Characteristics (V_{O1})

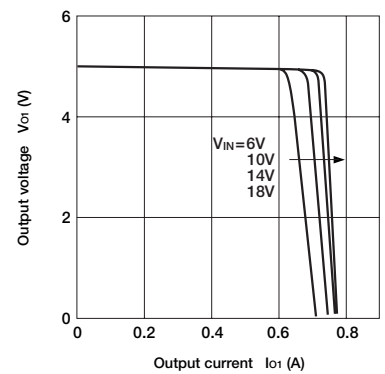

■ Overcurrent Protection Characteristics (V_{O2})

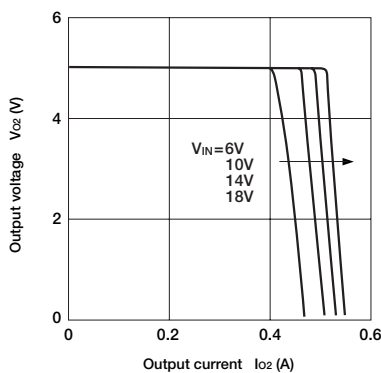

■ Thermal Protection Characteristics

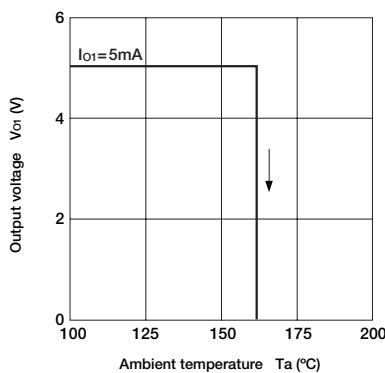

■ T_a—P_D Characteristics

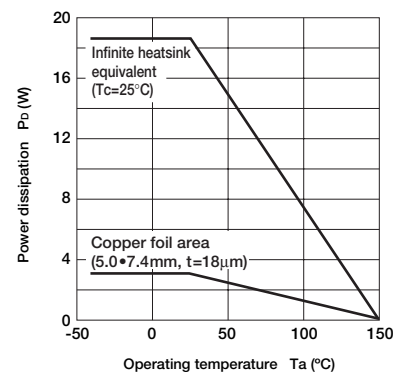

Switching Type Regulator ICs SI-3201S

Features

- Output current of 3A ($T_a=25^\circ\text{C}$, $V_{IN}=8$ to 18V)
- High efficiency of 82% ($V_{IN}=14\text{V}$, $I_O=2\text{A}$)
- Requires 5 external components only
- Built-in reference oscillator (60kHz)
- Phase internally corrected
- Output voltage internally corrected
- Built-in overcurrent and thermal protection circuits
- Built-in soft start circuit

Absolute Maximum Ratings

($T_a=25^\circ\text{C}$)

Parameter	Symbol	Ratings	Unit	Conditions
Input voltage	V_{IN}	35	V	
Output voltage	I_O	3	A	
SW _{OUT} terminal voltage	V_{SWOUT}	-1	V	
Power Dissipation	P_{D1}	22	W	With infinite heatsink
	P_{D2}	1.8	W	Stand-alone
Junction temperature	T_J	-40 to +150	$^\circ\text{C}$	
Storage temperature	T_{stg}	-40 to +125	$^\circ\text{C}$	
Junction to case thermal resistance	θ_{j-c}	5.5	$^\circ\text{C}/\text{W}$	
Junction to ambient-air thermal resistance	θ_{j-a}	66.7	$^\circ\text{C}/\text{W}$	

Recommended Operating Conditions

Parameter	Symbol	Ratings			Unit	Conditions
		min	typ	max		
Input voltage	V_{IN}	8		18	V	
Output current	I_O	0.5		3	A	
Operating temperature	T_{op}	-40		+85	$^\circ\text{C}$	T_a-P_D characteristics

Electrical Characteristics

($V_{IN}=14\text{V}$, $I_{OUT}=2\text{A}$, $T_J=25^\circ\text{C}$ unless otherwise specified)

Parameter	Symbol	Ratings			Unit	Conditions	
		min	typ	max			
Output voltage	V_O	4.80	5.00	5.20	V		
Line regulation	$\Delta V_{O\text{LINE}}$			100	mV	$V_{IN}=8$ to 18V	
Load regulation	$\Delta V_{O\text{LOAD}}$			50	mV	$I_O=0.5$ to 3A	
Efficiency *1	η		82		%		
Oscillation frequency	f_{OSC}	50	60	70	kHz		
Quiescent circuit current	I_q		5	10	mA	$I_O=0\text{A}$	
Overcurrent protection starting current	I_S	3.1			A	*2	
Soft start *3	Low level voltage	V_{SSL}		0.2	V		
	Source current when low	I_{SSL}	15	25	35	μA	$V_{SSL}=0.2\text{V}$
	Discharge resistance	R_{DIS}		200		$\text{k}\Omega$	$V_{IN}=0\text{V}$

Notes:

*1. Efficiency is calculated by the following equation:

$$\eta = \frac{V_O \cdot I_O}{V_{IN} \cdot I_{IN}} \cdot 100 (\%)$$

*2. A drooping-type overcurrent protection circuit is built in the IC.

*3. An external voltage may not be applied to the soft start terminal. As shown in the diagram to the right, use this IC in the soft start mode with a capacitor or in the open-collector drive mode with a transistor. Leave the soft start terminal open when not using it since it is already pulled up in the IC.

External Dimensions (unit: mm)

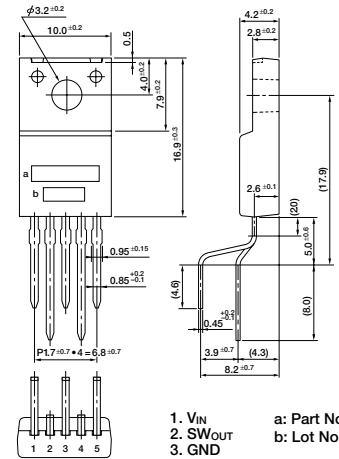

1. V_{IN}
2. SW_{OUT}
3. GND
4. V_S
5. SS
- a: Part No.
b: Lot No.

(Forming No. 1101)

Standard Circuit Diagram

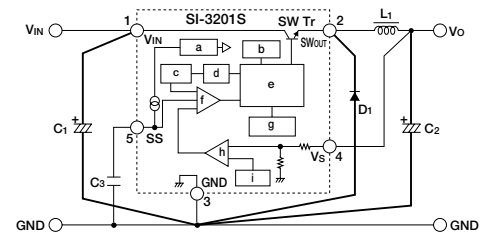

C1: 1000 μF
C2: 1000 μF

L1: 250 μH
D1: RK46 (Sanken)

- a: Internal power supply
b: Thermal protection
c: Reference oscillator
d: Reset
e: Latch & driver
f: Comparator
g: Overcurrent protection
h: Error amplifier
i: Reference voltage

Cautions:

- (1) A high-ripple current flows through C1 and C2. Use high-ripple type 1000 μF or higher capacitors with low internal resistance. Refer to the respective data books for more information on reliability and electrical characteristics of the capacitor.
- (2) C3 is a capacitor used for soft start.
- (3) L1 should be a choke coil with a low core loss for switching power supplies.
- (4) Use a Schottky barrier diode for D1 and make sure that the reverse voltage applied to the 2nd terminal (SW_{OUT} terminal) is within the maximum ratings (-1V). If you use a fast-recovery diode, the recovery voltage and the ON forward voltage may cause a reversed-bias voltage exceeding the maximum ratings to be applied to the 2nd terminal (SW_{OUT} terminal). Applying a reversed-bias voltage exceeding the maximum rating to the 2nd terminal (SW_{OUT} terminal) may damage the IC.
- (5) The 4th terminal (V_S) is an output voltage detection terminal. Since this terminal has a high impedance, connect it to the positive (+) terminal of C2 via the shortest possible route.
- (6) Leave the 5th terminal (soft start terminal) open when not using it. It is pulled up internally.
- (7) To ensure optimum operating environment, connect the high-frequency current line with minimum wiring length.

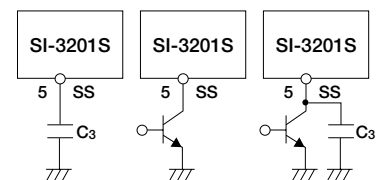

Electrical Characteristics

Line Regulation

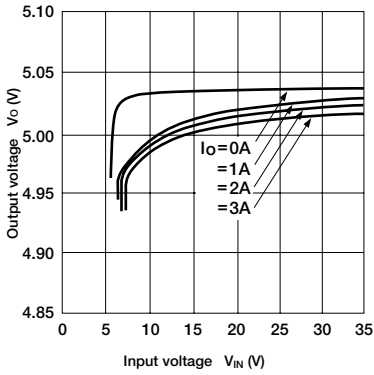

Load Regulation

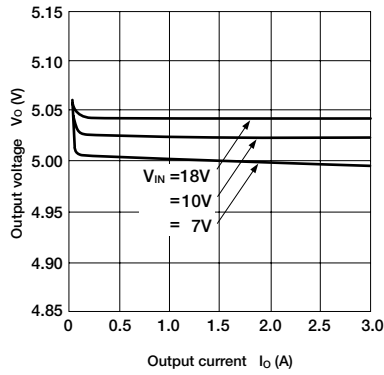

Rise Characteristics

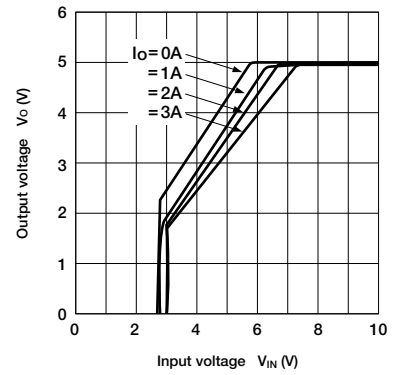

Efficiency Curve

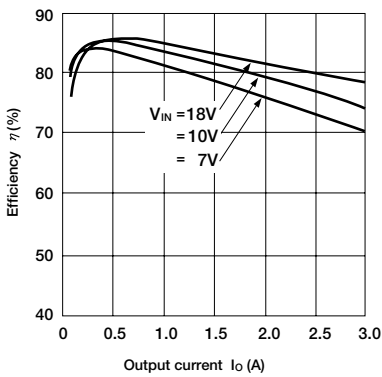

Overcurrent Protection Characteristics

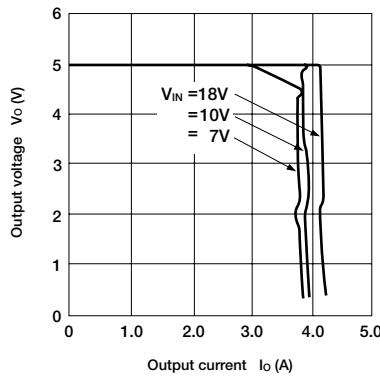

Overcurrent Protection Temperature Characteristics

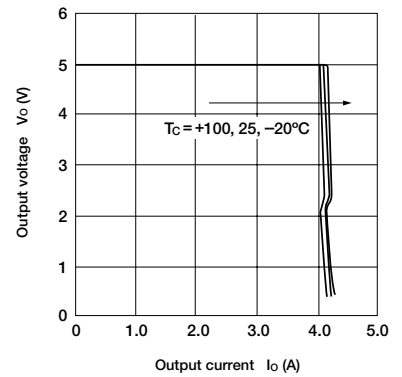

Ta—Pd Characteristics

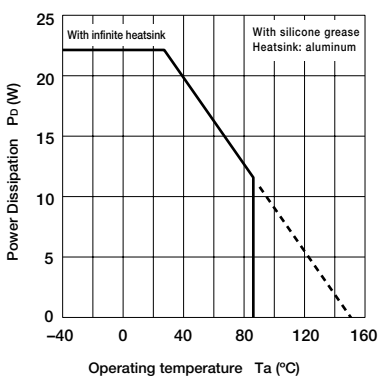

High-side Power Switch ICs [With Diagnostic Function, Surface-mount 2-circuits] SDH04

Features

- Built-in diagnostic function to detect short and open circuiting of loads and output status signals
- Low saturation PNP transistor use
- Allows direct driving using LS-TTL and C-MOS logic levels
- Built-in overcurrent protection circuits
- Built-in protection against reverse connection of power supply
- $T_j = 150^\circ\text{C}$ guaranteed
- Surface-mount full-mold package

Absolute Maximum Ratings

($T_a=25^\circ\text{C}$)

Parameter	Symbol	Ratings	Unit	Conditions
Power supply voltage	V_B	-13 to +40	V	
Drive terminal applied voltage	V_D	-0.3 to V_B	V	
Input terminal voltage	V_{IN}	-0.3 to +7.0	V	
DIAG output applied voltage	V_{DIAG}	-0.3 to +7.0	V	
DIAG output source current	I_{DIAG}	3	mA	
Voltage across power supply and drive terminal	V_{B-D}	$V_B - 0.4$	V	
Output current	I_O	1.5	A	
Power dissipation	P_D	2.6	W	Without heatsink, all circuits operating
Junction temperature	T_j	-40 to +150	$^\circ\text{C}$	
Operating temperature	T_{OP}	-40 to +100	$^\circ\text{C}$	
Storage temperature	T_{stg}	-40 to +150	$^\circ\text{C}$	

Electrical Characteristics

($V_{Bopr}=14\text{V}$, $T_a=25^\circ\text{C}$ unless otherwise specified)

Parameter	Symbol	Ratings			Unit	Conditions
		min	typ	max		
Operating power supply voltage	V_{Bopr}	6.0		16	V	
Quiescent circuit current	I_q		5	12	mA	Lo output
Threshold input voltage	V_{INth}	0.8		3.0	V	
Input current	Hi output	I_{IN}		1.0	mA	$V_{IN}=5\text{V}$
	Lo output	I_{IN}	0	100	μA	$V_{IN}=0\text{V}$
Saturation voltage of output transistor	$V_{CE(sat)}$			0.5	V	$I_O \leq 1.0\text{A}$, $V_{Bopr}=6$ to 16V
Output terminal sink current	$I_{O(off)}$			2.0	mA	$V_O=0\text{V}$, $V_{IN}=0\text{V}$
Saturation voltage of DIAG output	V_{DL}			0.3	V	$I_{DIAG}=3\text{mA}$
Leak current of DIAG output	I_{DGH}			100	μA	$V_{DIAG}=5\text{V}$
Open load detection resistor	R_{open}	1		30	k Ω	
Overcurrent protection starting current	I_s	1.6			A	$V_O=V_{Bopr}-1.9\text{V}$
Output transfer time	T_{ON}		8	30	μs	$I_O=1\text{A}$
	T_{OFF}		15	30	μs	$I_O=1\text{A}$
DIAG output transfer time	T_{PLH}		10	30	μs	$I_O=1\text{A}$
	T_{PHL}		15	30	μs	$I_O=1\text{A}$

Note: * The rule of protection against reverse connection of power supply is $V_B = -13\text{V}$, one minute (all terminals except, V_B and GND, are open).

Diagnostic Function

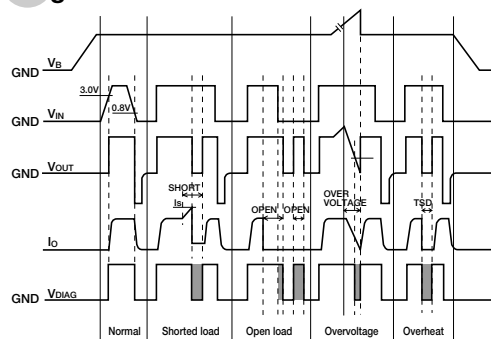

External Dimensions (unit: mm) SMD-16A

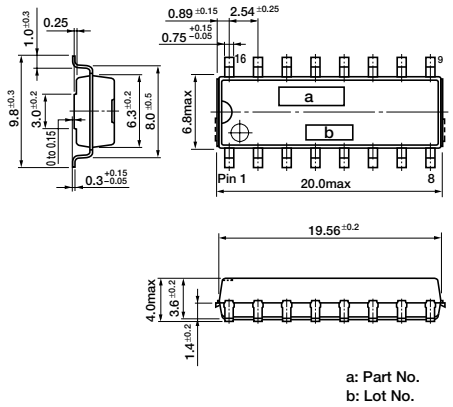

Equivalent Circuit Diagram

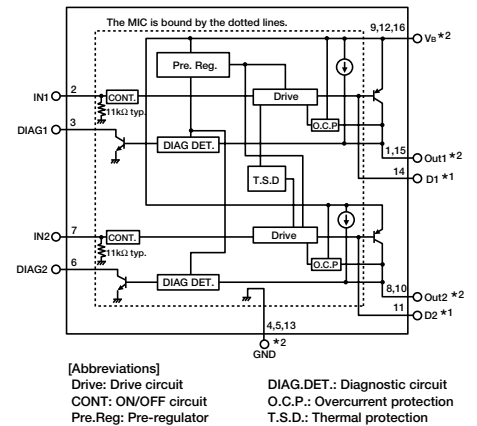

[Abbreviations]
 Drive: Drive circuit
 CONT: ON/OFF circuit
 Pre.Reg: Pre-regulator
 DIAG.DET.: Diagnostic circuit
 O.C.P.: Overcurrent protection
 T.S.D.: Thermal protection

- *1. The base terminal (D terminal) is connected to the output transistor base. It is also connected to the control monolithic IC. Do not, therefore, apply an external voltage in operation.
- *2. SDH04 have two or three terminals of the same function (V_B , Out1, Out2, GND). The terminals of the same function must be shorted at a pattern near the product.

Standard Circuit Diagram

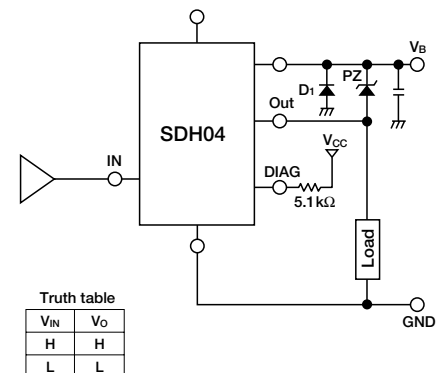

Note 1: A pull-down resistor (11 k Ω typ.) is connected to the IN terminal. V_{OUT} turns "L" when a high impedance is connected to the IN terminal in series.

Electrical Characteristics

■ Quiescent Circuit Current (dual circuit)

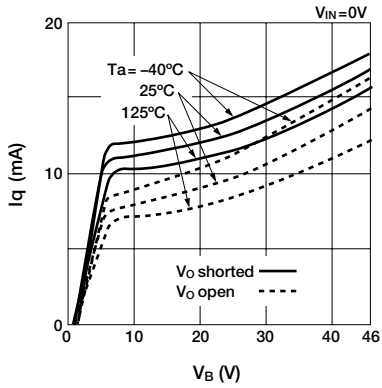

■ Circuit Current (single circuit)

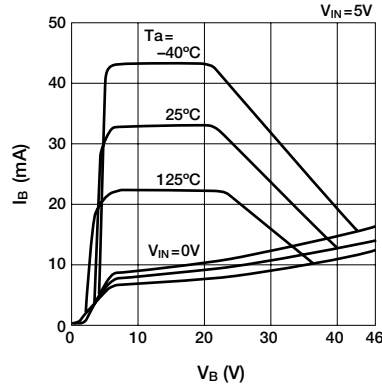

■ Circuit Current (dual circuit)

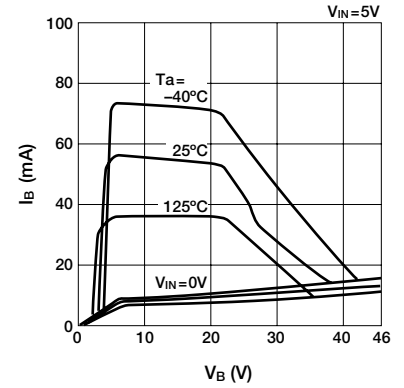

■ Saturation Voltage of Output Transistor

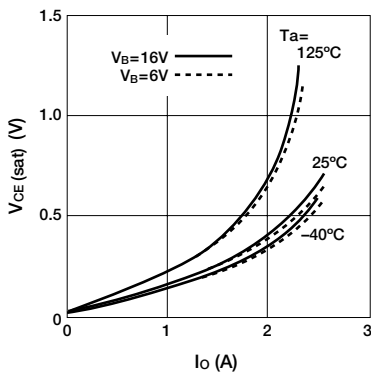

■ Overcurrent Protection Characteristics ($T_a = -40^\circ\text{C}$)

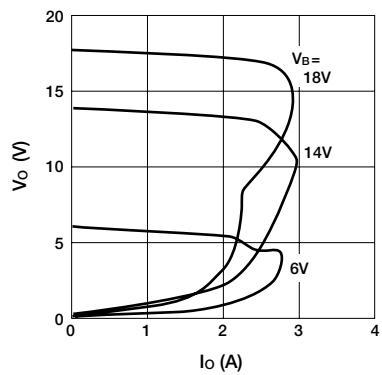

■ Overcurrent Protection Characteristics ($T_a = 25^\circ\text{C}$)

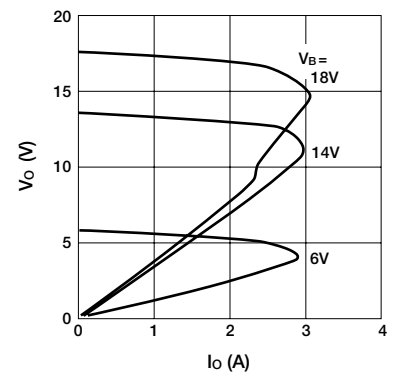

■ Overcurrent Protection Characteristics ($T_a = 125^\circ\text{C}$)

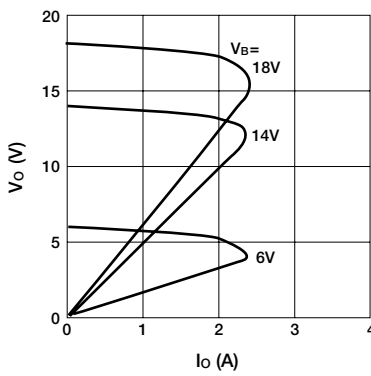

■ Threshold Characteristics of Input Voltage

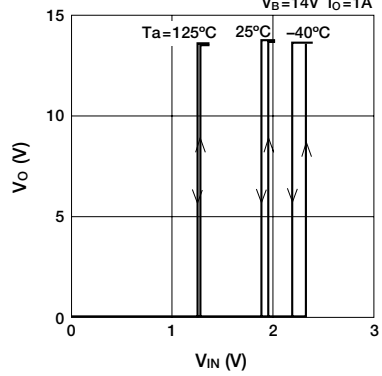

■ Input Terminal Source Current

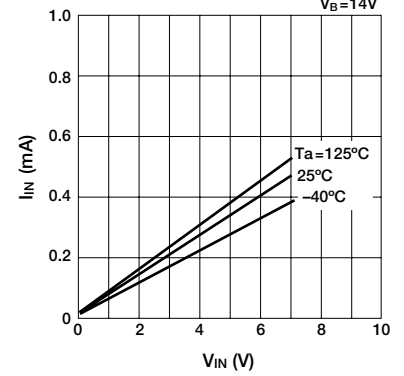

■ Input Terminal Sink Current

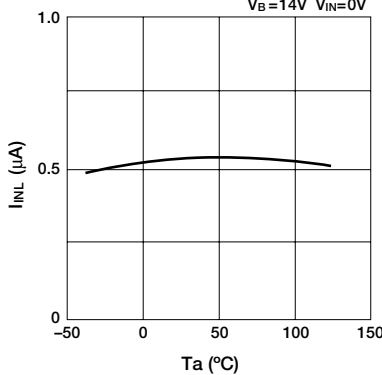

■ Saturation Voltage of DIAG Output

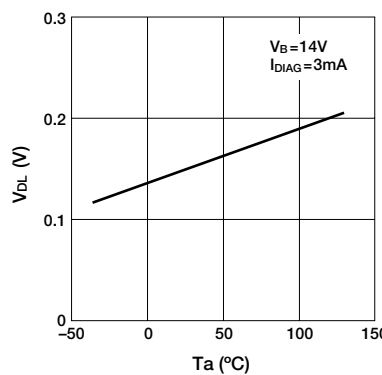

High-side Power Switch ICs [With Diagnostic Function] SI-5151S

Features

- Built-in diagnostic function to detect short and open circuiting of loads and output status signals
- Low saturation PNP transistor use
- Allows direct driving using LS-TTL and C-MOS logic levels
- Built-in overcurrent and thermal protection circuits
- Built-in protection against reverse connection of power supply
- TO220 equivalent full-mold package not require insulation mica

Absolute Maximum Ratings

(Ta=25°C)

Parameter	Symbol	Ratings	Unit	Conditions
Power supply voltage	V _B	40	V	
Input terminal voltage	V _{IN}	-0.3 to V _B	V	
DIAG terminal voltage	V _{DIAG}	6	V	
Collector-emitter voltage	V _{CE}	40	V	
Output current	I _O	1.8	A	
Power Dissipation	P _{D1}	18	W	With infinite heatsink (T _c =25°C)
	P _{D2}	1.5	W	Stand-alone without heatsink (T _c =25°C)
Junction temperature	T _J	-40 to +125	°C	
Operating temperature	T _{OP}	-40 to +100	°C	
Storage temperature	T _{stg}	-40 to +125	°C	

External Dimensions (unit: mm)

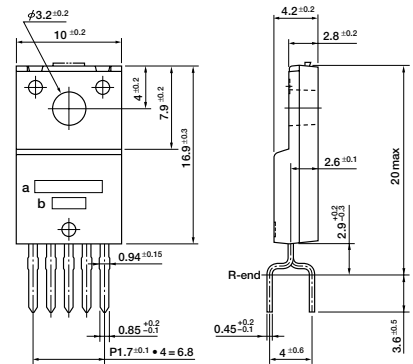

1. GND
 2. V_{IN}
 3. V_O
 4. DIAG
 5. V_B
- a: Part No.
b: Lot No.

(Forming No. 1123)

Electrical Characteristics

(Ta=25°C unless otherwise specified)

Parameter	Symbol	Ratings			Unit	Conditions
		min	typ	max		
Operating power supply voltage	V _{Bopr}	6.0		30	V	
Quiescent circuit current	I _q		5	12	mA	V _{Bopr} =14V, V _{IN} =0V
Saturation voltage of output transistor	V _{CE(sat)}			0.5	V	I _O ≤ 1.0A, V _{Bopr} =6 to 16V
				1.0	V	I _O ≤ 1.8A, V _{Bopr} =6 to 16V
Output leak current	I _{O, leak}			2	mA	V _{CEO} =16V
Input voltage	Output ON	V _{IH}	2.0	V _B	V	V _{Bopr} =6 to 16V
	Output OFF	V _{IL}	-0.3	0.8	V	V _{Bopr} =6 to 16V
Input current	Output ON	I _{IH}		1	mA	V _{IN} =5V
	Output OFF	I _{IL}	-0.1		mA	V _{IN} =0V
Overcurrent protection starting current	I _s	1.9			A	V _{Bopr} =14V, V _O =V _{Bopr} -1.5V
Thermal protection starting temperature	T _{TSD}	125	145		°C	
Open load detection resistor	R _{open}			30	kΩ	V _{Bopr} =6 to 16V
Output transfer time	T _{ON}		8	30	μs	V _{Bopr} =14V, I _O =1A
	T _{OFF}		15	30	μs	V _{Bopr} =14V, I _O =1A
DIAG output voltage	V _{DH}	4.5		6	V	V _{CC} =6V
	V _{DL}			0.3	V	V _{CC} =6V, I _{DD} =2mA
DIAG output transfer time	T _{PLH}			30	μs	V _{Bopr} =14V, I _O =1A
	T _{PHL}			30	μs	V _{Bopr} =14V, I _O =1A
Minimum load inductance	L	1			mH	

Note:

* The rule of protection against reverse connection of power supply is V_B = -13V, one minute (all terminals except, V_B and GND, are open).

Standard Circuit Diagram

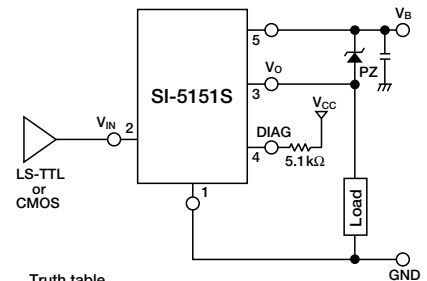

Truth table

V _{IN}	V _O
H	H
L	L

Diagnostic Function

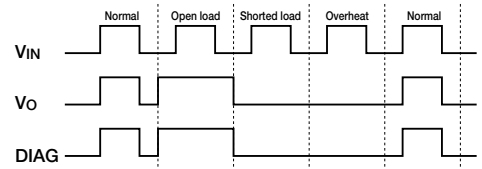

Mode	V _{IN}	V _O	DIAG
Normal	L	L	L
Open load	L	H	H
Shorted load	L	L	L
Overheat	L	L	L

- DIAG output will be undetermined when a voltage exceeding 25V is applied to V_B terminal.

Electrical Characteristics

■ Quiescent Circuit Current

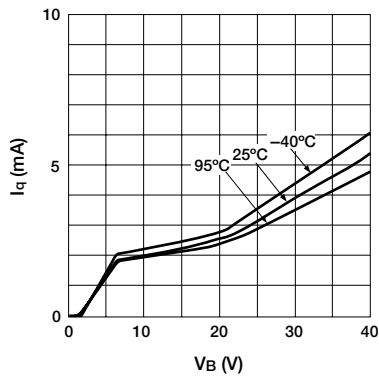

■ Circuit Current

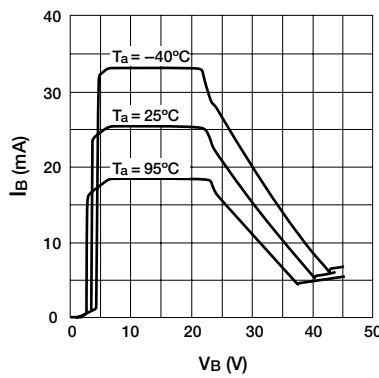

■ Saturation Voltage of Output Transistor

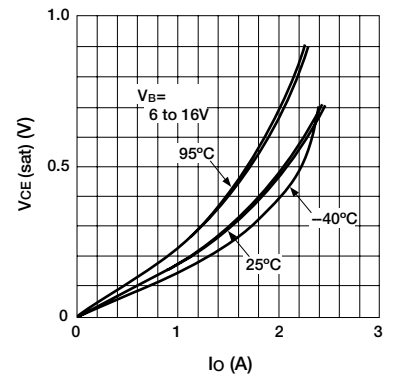

■ Overcurrent Protection Characteristics ($T_a = -40^\circ\text{C}$)

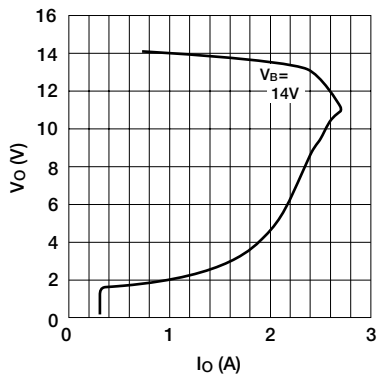

■ Overcurrent Protection Characteristics ($T_a = 25^\circ\text{C}$)

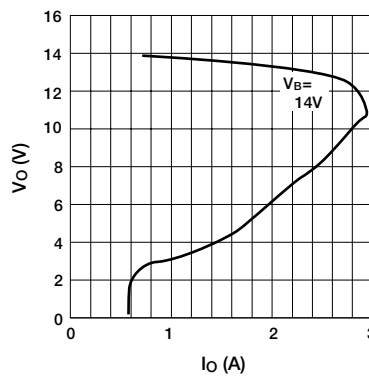

■ Overcurrent Protection Characteristics ($T_a = 100^\circ\text{C}$)

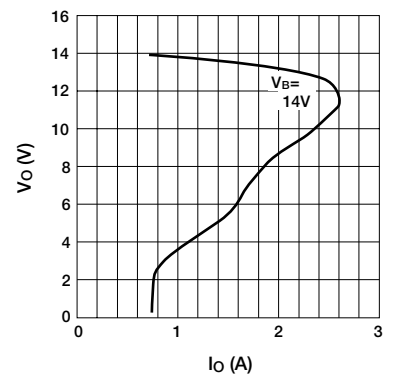

■ Threshold input voltage

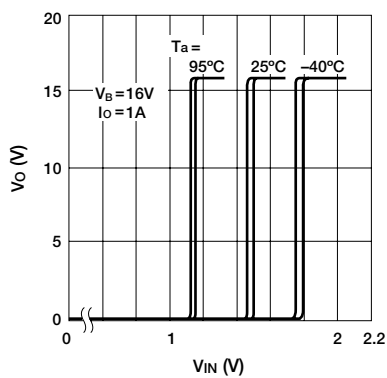

■ Input Current (Output ON)

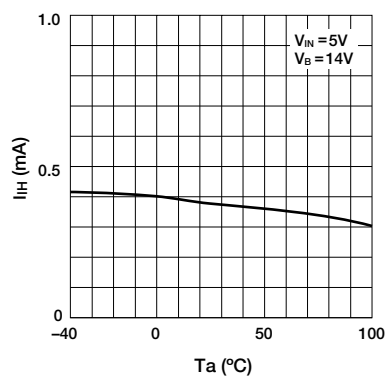

■ Input Current (Output OFF)

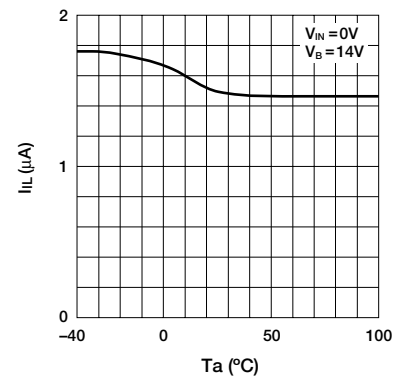

■ Saturation Voltage of DIAG Output

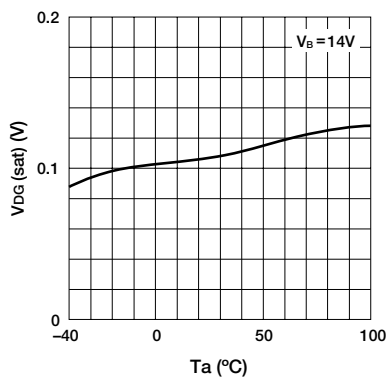

■ Thermal Protection Characteristics

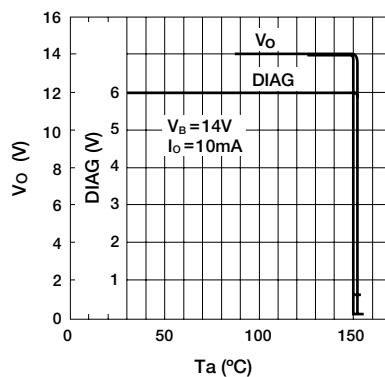

High-side Power Switch ICs [With Diagnostic Function] SI-5152S

Features

- Built-in diagnostic function to detect short and open circuiting of loads and output status signals
- Low saturation PNP transistor use
- Allows direct driving using LS-TTL and C-MOS logic levels
- Built-in overcurrent and thermal protection circuits
- Built-in protection against reverse connection of power supply
- $T_j = 150^\circ\text{C}$ guaranteed
- TO220 equivalent full-mold package not require insulation mica

Absolute Maximum Ratings

($T_a = 25^\circ\text{C}$)

Parameter	Symbol	Ratings	Unit	Conditions
Power supply voltage	V_B	40	V	
Input terminal voltage	V_{IN}	-0.3 to V_B	V	
DIAG terminal voltage	V_{DIAG}	6	V	
Collector-emitter voltage	V_{CE}	40	V	
Output current	I_O	1.8	A	
Power Dissipation	P_{D1}	22	W	With infinite heatsink ($T_c = 25^\circ\text{C}$)
	P_{D2}	1.8	W	Stand-alone without heatsink
Junction temperature	T_j	-40 to +150	$^\circ\text{C}$	
Operating temperature	T_{OP}	-40 to +100	$^\circ\text{C}$	
Storage temperature	T_{stg}	-40 to +150	$^\circ\text{C}$	

Electrical Characteristics

($T_a = 25^\circ\text{C}$ unless otherwise specified)

Parameter	Symbol	Ratings			Unit	Conditions
		min	typ	max		
Operating power supply voltage	V_{Bopr}	6.0		30	V	
Quiescent circuit current	I_q		5	12	mA	$V_{Bopr} = 14\text{V}$, $V_{IN} = 0\text{V}$
Saturation voltage of output transistor	$V_{CE(sat)}$			0.5	V	$I_O \leq 1.0\text{A}$, $V_{Bopr} = 6$ to 16V
				1.0	V	$I_O \leq 1.8\text{A}$, $V_{Bopr} = 6$ to 16V
Output leak current	$I_{o, leak}$			2	mA	$V_{CE0} = 16\text{V}$, $V_{IN} = 0\text{V}$
Input voltage	Output ON	V_{IH}	2.0	V_B	V	$V_{Bopr} = 6$ to 16V
	Output OFF	V_{IL}	-0.3	0.8	V	$V_{Bopr} = 6$ to 16V
Input current	Output ON	I_{IH}		1	mA	$V_{IN} = 5\text{V}$
	Output OFF	I_{IL}	-0.1		mA	$V_{IN} = 0\text{V}$
Overcurrent protection starting current	I_S	1.9			A	$V_{Bopr} = 14\text{V}$, $V_O = V_{Bopr} - 1.5\text{V}$
Thermal protection starting temperature	T_{TSD}	150			$^\circ\text{C}$	$V_{Bopr} \geq 6\text{V}$
Open load detection resistor	R_{open}			30	k Ω	$V_{Bopr} = 6$ to 16V
Output transfer time	T_{ON}		8	30	μs	$V_{Bopr} = 14\text{V}$, $I_O = 1\text{A}$
	T_{OFF}		15	30	μs	$V_{Bopr} = 14\text{V}$, $I_O = 1\text{A}$
DIAG output leak current	I_{DIAG}			100	μA	$V_{CC} = 6\text{V}$, $V_{Bopr} = 6$ to 16V
Saturation voltage of DIAG output	V_{DL}			0.3	V	$V_{CC} = 6\text{V}$, $V_{Bopr} = 6$ to 16V , $I_{DO} = 2\text{mA}$
DIAG output transfer time	T_{PLH}			30	μs	$V_{Bopr} = 14\text{V}$, $I_O = 1\text{A}$
	T_{PHL}			30	μs	$V_{Bopr} = 14\text{V}$, $I_O = 1\text{A}$
Minimum load inductance	L	1			mH	

Note:

* The rule of protection against reverse connection of power supply is $V_B = -13\text{V}$, one minute (all terminals except, V_B and GND, are open).

External Dimensions (unit: mm)

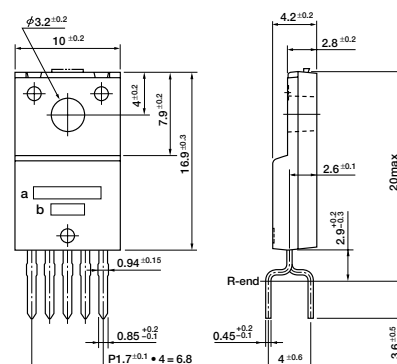

1. GND
 2. V_{IN}
 3. V_O
 4. DIAG
 5. V_B
- a: Part No.
b: Lot No.

(Forming No. 1123)

Standard Circuit Diagram

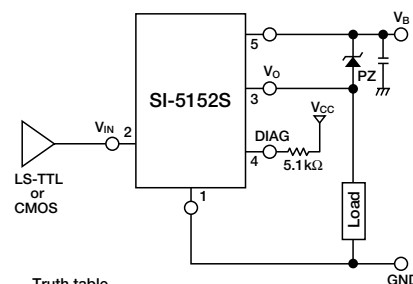

Truth table

V_{IN}	V_O
H	H
L	L

Diagnostic Function

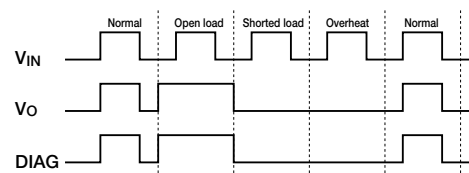

Mode	V_{IN}	V_O	DIAG
Normal	H	H	H
Open load	L	H	H
Shorted load	L	L	L
Overheat	L	L	L

- DIAG output will be undetermined when a voltage exceeding 25V is applied to V_B terminal.

Electrical Characteristics

■ Quiescent Circuit Current

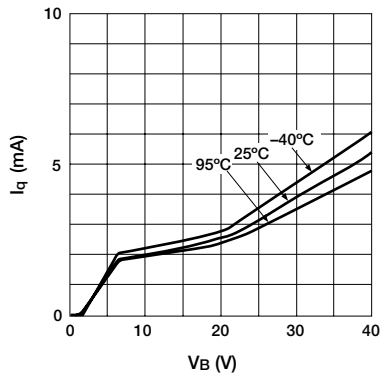

■ Circuit Current

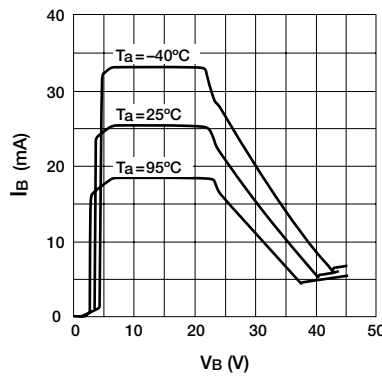

■ Saturation Voltage of Output Transistor

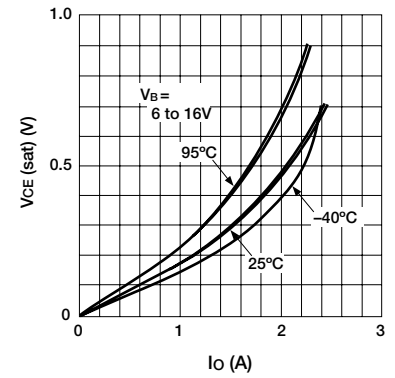

■ Overcurrent Protection Characteristics ($T_a = -40^\circ\text{C}$)

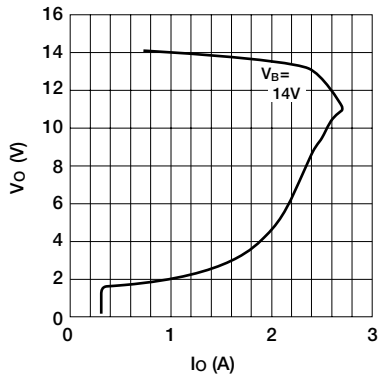

■ Overcurrent Protection Characteristics ($T_a = 25^\circ\text{C}$)

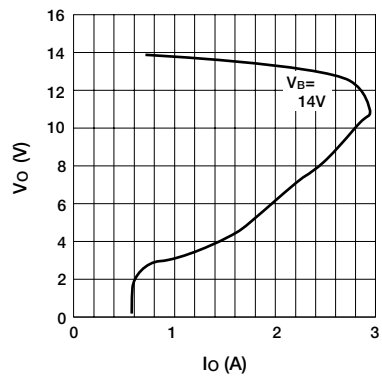

■ Overcurrent Protection Characteristics ($T_a = 100^\circ\text{C}$)

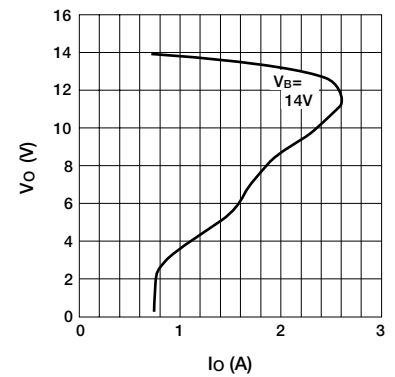

■ Threshold input voltage

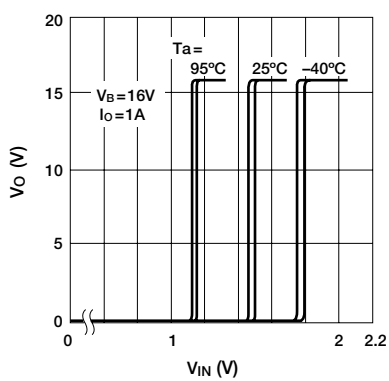

■ Input Current (Output ON)

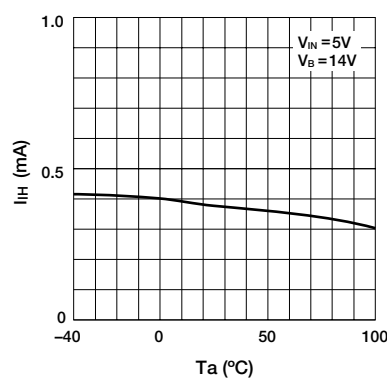

■ Input Current (Output OFF)

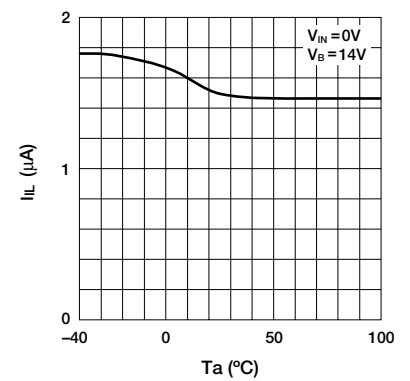

■ Saturation Voltage of DIAG Output

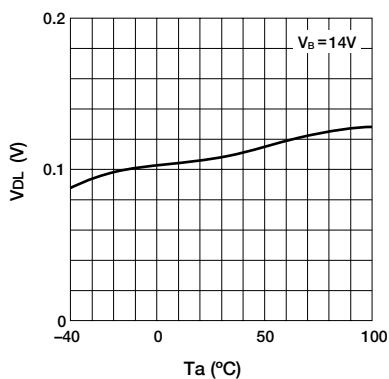

Features

- Built-in diagnostic function to detect short and open circuiting of loads and output status signals
- Low saturation PNP transistor use
- Allows direct driving using LS-TTL and C-MOS logic levels
- Built-in overcurrent and thermal protection circuits
- Built-in protection against reverse connection of power supply
- $T_j = 150^\circ\text{C}$ guaranteed
- Built-in Zener diode
- TO220 equivalent full-mold package not require insulation mica

Absolute Maximum Ratings

($T_a = 25^\circ\text{C}$)

Parameter	Symbol	Ratings	Unit	Conditions
Power supply voltage	V_B	-13 to +40	V	
Input terminal voltage	V_{IN}	-0.3 to V_B	V	
DIAG terminal voltage	V_{DIAG}	6	V	
Collector-emitter voltage	V_{CE}	$V_B - V_Z$	V	Refer to "Surge clamp voltage" in Electrical Characteristics
Output current	I_O	2.04	A	
Power Dissipation	P_{D1}	22	W	With infinite heatsink ($T_c = 25^\circ\text{C}$)
	P_{D2}	1.8	W	Stand-alone without heatsink
Junction temperature	T_j	-40 to +150	$^\circ\text{C}$	
Operating temperature	T_{OP}	-40 to +100	$^\circ\text{C}$	
Storage temperature	T_{stg}	-40 to +150	$^\circ\text{C}$	

Electrical Characteristics

($T_a = 25^\circ\text{C}$ unless otherwise specified)

Parameter	Symbol	Ratings			Unit	Conditions	
		min	typ	max			
Operating power supply voltage	V_{Bopr}	6.0		30	V		
Quiescent circuit current	I_q		5	12	mA	$V_{Bopr} = 14\text{V}$, $V_{IN} = 0\text{V}$	
Saturation voltage of output transistor	$V_{CE(sat)}$			0.47	V	$I_O \leq 2.05\text{A}$, $V_{Bopr} = 6$ to 16V	
Output leak current	$I_{O, leak}$			2	mA	$V_{CE} = 16\text{V}$, $V_{IN} = 0\text{V}$	
Input voltage	Output ON	V_{IH}	2.0		V_B	V	$V_{Bopr} = 6$ to 16V
	Output OFF	V_{IL}	-0.3		0.8	V	$V_{Bopr} = 6$ to 16V
Input current	Output ON	I_{IH}		1	mA	$V_{IN} = 5\text{V}$	
	Output OFF	I_{IL}	-0.1		mA	$V_{IN} = 0\text{V}$	
Overcurrent protection starting current	I_S	2.05			A	$V_{Bopr} = 14\text{V}$, $V_O = V_{Bopr} - 1.5\text{V}$	
Thermal protection starting temperature	T_{TSD}	150			$^\circ\text{C}$	$V_{Bopr} \geq 6\text{V}$	
Open load detection resistor	R_{open}			30	$\text{k}\Omega$	$V_{Bopr} = 6$ to 16V	
Output transfer time	T_{ON}		8	30	μs	$V_{Bopr} = 14\text{V}$, $I_O = 1\text{A}$	
	T_{OFF}		15	30	μs	$V_{Bopr} = 14\text{V}$, $I_O = 1\text{A}$	
DIAG output voltage	V_{DH}	4.5		6	V	$V_{CC} = 6\text{V}$, $V_{Bopr} = 6$ to 16V	
	V_{DL}			0.3	V	$V_{CC} = 6\text{V}$, $V_{Bopr} = 6$ to 16V , $I_{DO} = 2\text{mA}$	
DIAG output transfer time	T_{PLH}			30	μs	$V_{Bopr} = 14\text{V}$, $I_O = 1\text{A}$	
	T_{PHL}			30	μs	$V_{Bopr} = 14\text{V}$, $I_O = 1\text{A}$	
Minimum load inductance	L	1			mH		
Surge clamp voltage *1	V_Z	28	34	40	V	$I_C = 5\text{mA}$	

Note:

*1. The Zener diode for surge clamping has an energy capability of 140 mJ (single pulse).

* The rule of protection against reverse connection of power supply is $V_B = -13\text{V}$, one minute.

* This driver is exclusively used for ON/OFF control.

External Dimensions (unit: mm)

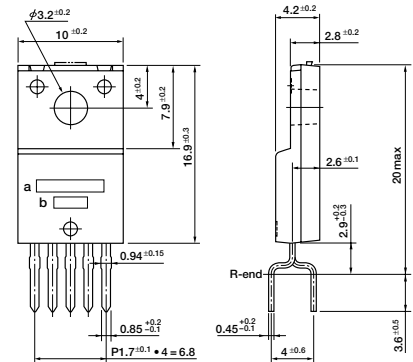

1. GND
 2. V_{IN}
 3. V_O
 4. DIAG
 5. V_B
- a: Part No.
b: Lot No.

(Forming No. 1123)

Standard Circuit Diagram

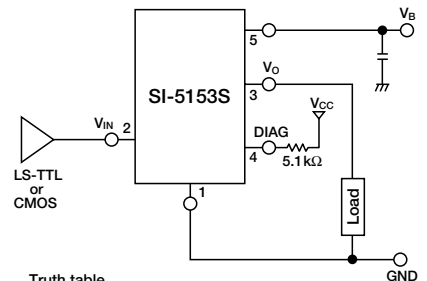

Truth table

V_{IN}	V_O
H	H
L	L

Diagnostic Function

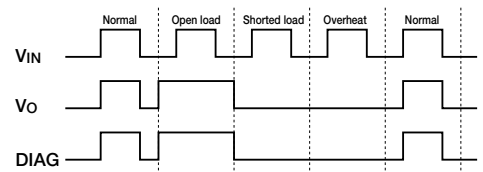

Mode	V_{IN}	V_O	DIAG
Normal	L	L	L
Open load	L	H	H
Shorted load	L	L	L
Overheat	L	L	L

- DIAG output will be undetermined when a voltage exceeding 25V is applied to V_B terminal.

Electrical Characteristics

■ Quiescent Circuit Current

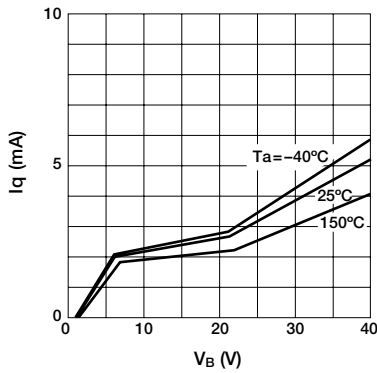

■ Circuit Current

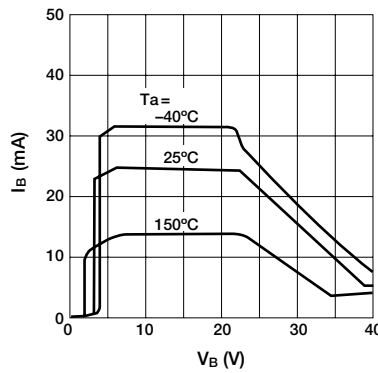

■ Saturation Voltage of Output Transistor

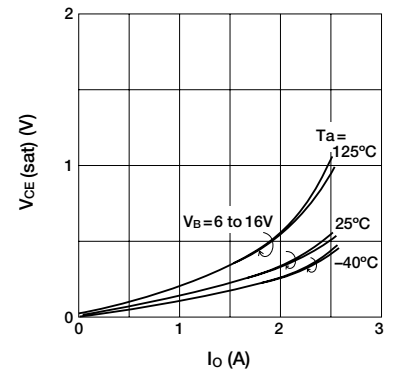

■ Overcurrent Protection Characteristics (Ta = -40°C)

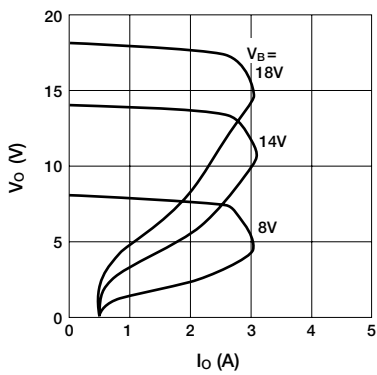

■ Overcurrent Protection Characteristics (Ta = 25°C)

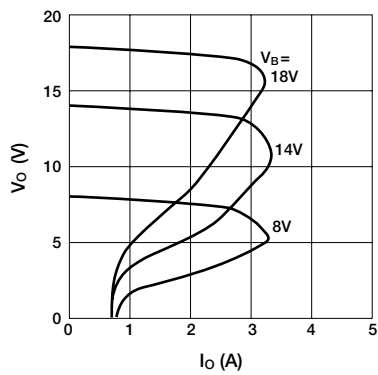

■ Overcurrent Protection Characteristics (Ta = 125°C)

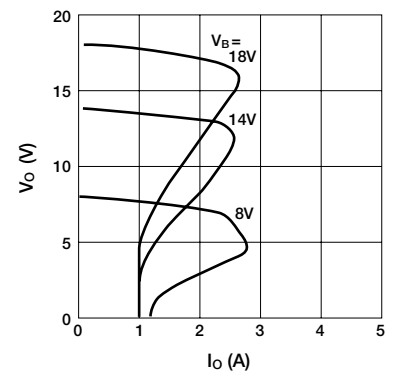

■ Threshold Characteristics of Input Voltage

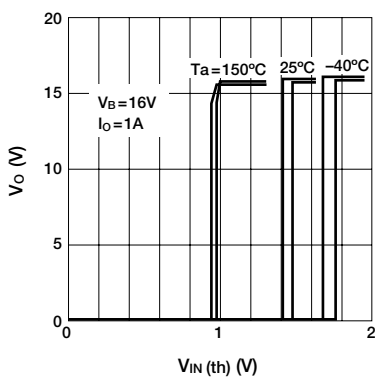

■ Input Current (Output ON)

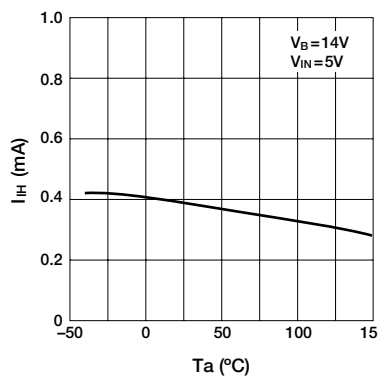

■ Input Current (Output OFF)

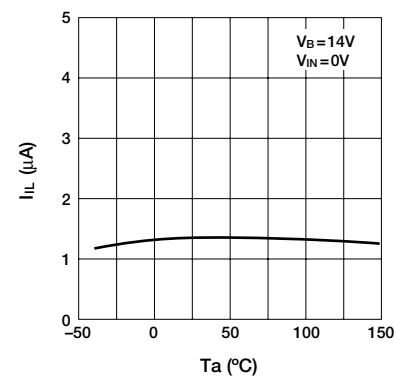

■ Output Terminal Leak Current

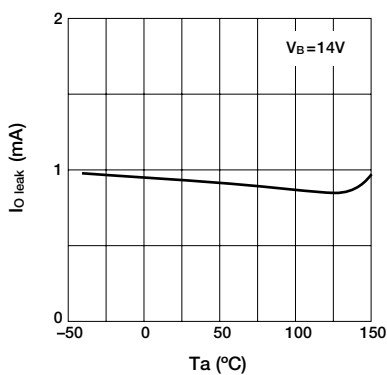

■ Saturation Voltage of DIAG Output

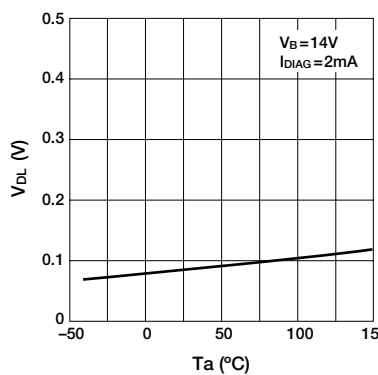

■ Thermal Protection Characteristics

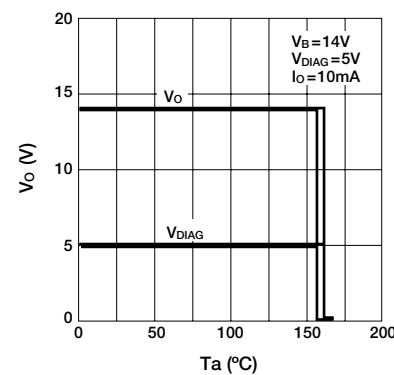

Features

- Built-in diagnostic function to detect short and open circuiting of loads and output status signals
- Low saturation PNP transistor use
- Allows direct driving using LS-TTL and C-MOS logic levels
- Built-in overcurrent and thermal protection circuits
- Built-in protection against reverse connection of power supply
- $T_j = 150^\circ\text{C}$ guaranteed
- Built-in Zener diode
- TO220 equivalent full-mold package not require insulation mica

Absolute Maximum Ratings

($T_a=25^\circ\text{C}$)

Parameter	Symbol	Ratings	Unit	Conditions
Power supply voltage	V_B	-13 to +40	V	
Input terminal voltage	V_{IN}	-0.3 to V_B	V	
DIAG terminal voltage	V_{DIAG}	6	V	
Collector-emitter voltage	V_{CE}	$V_B - V_Z$	V	Refer to "Surge clamp voltage" in Electrical Characteristics
Output current	I_O	2.5	A	
Power Dissipation	P_{D1}	22	W	With infinite heatsink ($T_c=25^\circ\text{C}$)
	P_{D2}	1.8	W	Stand-alone without heatsink
Junction temperature	T_j	-40 to +150	$^\circ\text{C}$	
Operating temperature	T_{OP}	-40 to +100	$^\circ\text{C}$	
Storage temperature	T_{stg}	-40 to +150	$^\circ\text{C}$	

Electrical Characteristics

($T_a=25^\circ\text{C}$ unless otherwise specified)

Parameter	Symbol	Ratings			Unit	Conditions
		min	typ	max		
Operating power supply voltage	V_{Bopr}	6.0		30	V	
Quiescent circuit current	I_q		5	12	mA	$V_{Bopr}=14\text{V}$, $V_{IN}=0\text{V}$
Saturation voltage of output transistor	$V_{CE(sat)}$			0.3	V	$I_O \leq 1.0\text{A}$, $V_{Bopr}=6$ to 16V
				0.72	V	$I_O \leq 2.5\text{A}$, $V_{Bopr}=6$ to 16V
Output leak current	$I_{o, leak}$			2	mA	$V_{CE0}=16\text{V}$, $V_{IN}=0\text{V}$
Input voltage	Output ON	V_{IH}	2.0	V_B	V	$V_{Bopr}=6$ to 16V
	Output OFF	V_{IL}	-0.3	0.8	V	$V_{Bopr}=6$ to 16V
Input current	Output ON	I_{IH}		1	mA	$V_{IN}=5\text{V}$
	Output OFF	I_{IL}	-0.1		mA	$V_{IN}=0\text{V}$
Overcurrent protection starting current	I_s	2.6			A	$V_{Bopr}=14\text{V}$, $V_O=V_{Bopr}-1.5\text{V}$
Thermal protection starting temperature	T_{TSD}	150			$^\circ\text{C}$	$V_{Bopr} \geq 6\text{V}$
Open load detection resistor	R_{open}			30	$\text{k}\Omega$	$V_{Bopr}=6$ to 16V
Output transfer time	T_{ON}		8	30	μs	$V_{Bopr}=14\text{V}$, $I_O=1\text{A}$
	T_{OFF}		15	30	μs	$V_{Bopr}=14\text{V}$, $I_O=1\text{A}$
DIAG output voltage	V_{DH}	4.5		6	V	$V_{CC}=6\text{V}$, $V_{Bopr}=6$ to 16V
	V_{DL}			0.3	V	$V_{CC}=6\text{V}$, $V_{Bopr}=6$ to 16V, $I_{D0}=2\text{mA}$
DIAG output transfer time	T_{PLH}			30	μs	$V_{Bopr}=14\text{V}$, $I_O=1\text{A}$
	T_{PHL}			30	μs	$V_{Bopr}=14\text{V}$, $I_O=1\text{A}$
Minimum load inductance	L	1			mH	
Surge clamp voltage ^{*1}	V_Z	28	34	40	V	$I_C=5\text{mA}$

Note:

- *1. The Zener diode for surge clamping has an energy capability of 200 mJ (single pulse).
- * The rule of protection against reverse connection of power supply is $V_B = -13\text{V}$, one minute.
- * This driver is exclusively used for ON/OFF control.

External Dimensions (unit: mm)

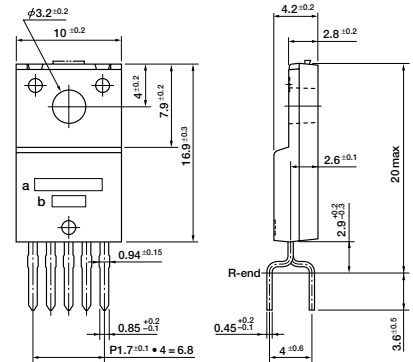

1. GND
 2. V_{IN}
 3. V_O
 4. DIAG
 5. V_B
- a: Part No.
b: Lot No.

(Forming No. 1123)

Standard Circuit Diagram

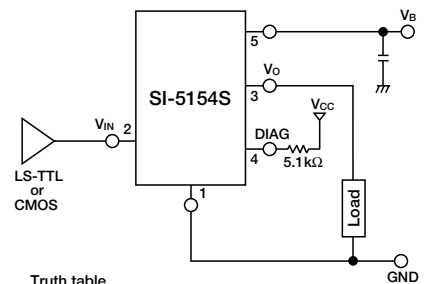

Truth table

V_{IN}	V_O
H	H
L	L

Diagnostic Function

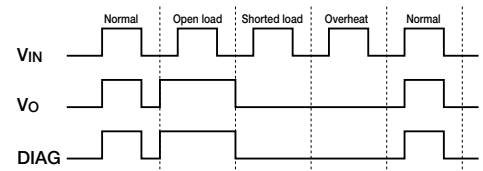

Mode	V_{IN}	V_O	DIAG
Normal	L	L	L
Normal	H	H	H
Open load	L	H	H
Open load	H	L	L
Shorted load	L	L	L
Shorted load	H	L	L
Overheat	L	L	L
Overheat	H	L	L

- DIAG output will be undetermined when a voltage exceeding 25V is applied to V_B terminal.

Electrical Characteristics

■ Quiescent Circuit Current

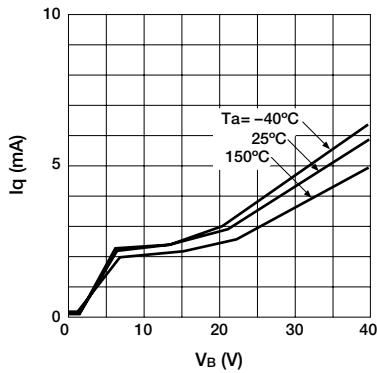

■ Circuit Current

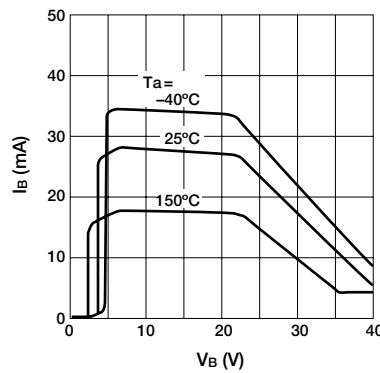

■ Saturation Voltage of Output Transistor

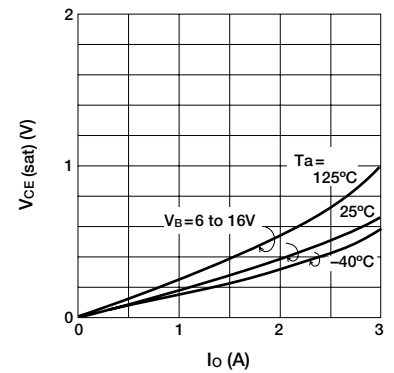

■ Overcurrent Protection Characteristics ($T_a = -40^\circ\text{C}$)

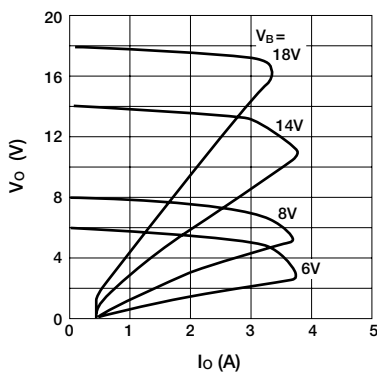

■ Overcurrent Protection Characteristics ($T_a = 25^\circ\text{C}$)

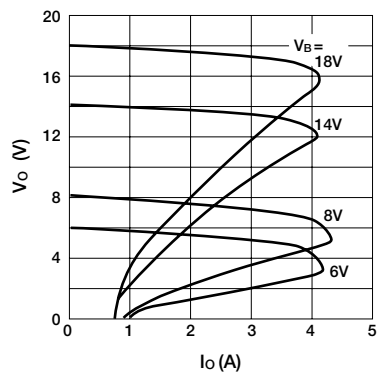

■ Overcurrent Protection Characteristics ($T_a = 125^\circ\text{C}$)

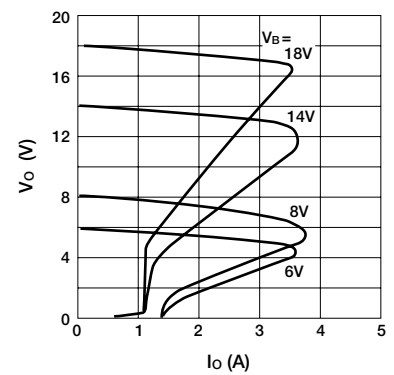

■ Threshold input voltage

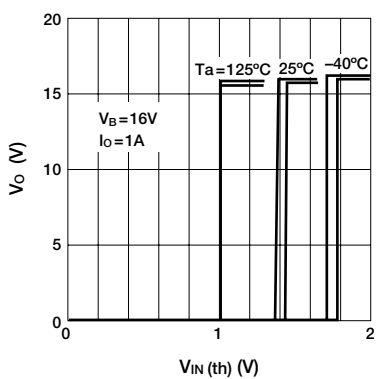

■ Input Current (Output ON)

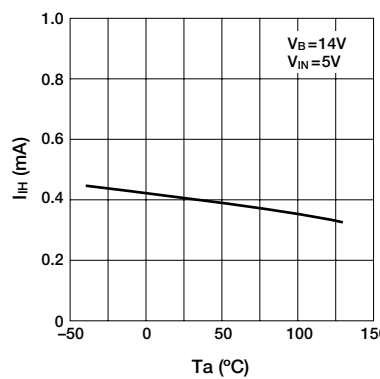

■ Input Current (Output OFF)

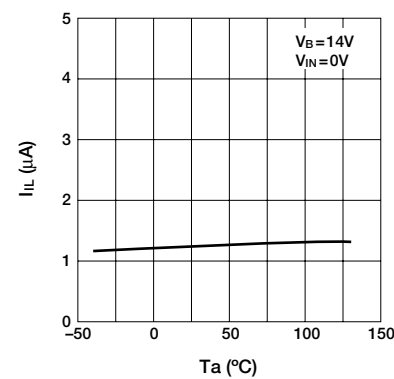

■ Output Terminal Leak Current

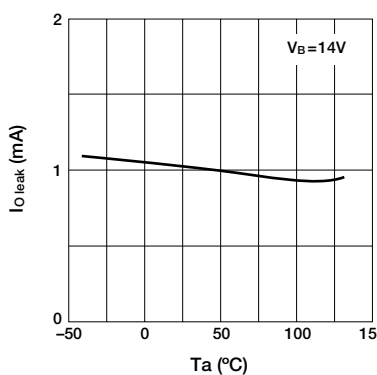

■ Saturation Voltage of DIAG Output

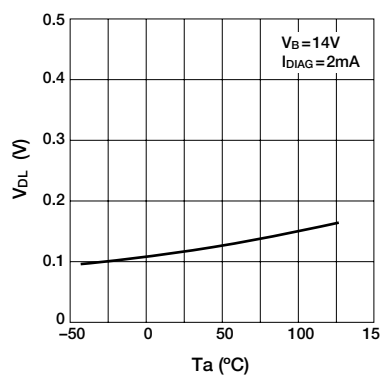

■ Thermal Protection Characteristics

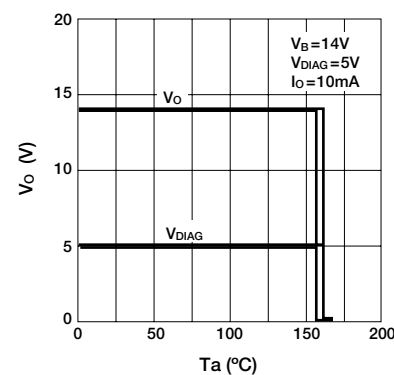

High-side Power Switch ICs [With Diagnostic Function] SI-5155S

Features

- Built-in diagnostic function to detect short and open circuiting of loads and output status signals
- Low saturation PNP transistor use
- Allows direct driving using LS-TTL and C-MOS logic levels
- Built-in overcurrent and thermal protection circuits
- Built-in protection against reverse connection of power supply
- $T_J = 150^\circ\text{C}$ guaranteed
- TO220 equivalent full-mold package not require insulation mica

Absolute Maximum Ratings

($T_a = 25^\circ\text{C}$)

Parameter	Symbol	Ratings	Unit	Conditions
Power supply voltage	V_B	-13 to +40	V	
Input terminal voltage	V_{IN}	-0.3 to V_B	V	
DIAG terminal voltage	V_{DIAG}	6	V	
Collector-emitter voltage	V_{CE}	40	V	
Output current	I_O	2.5	A	
Power dissipation	P_{D1}	22	W	With infinite heatsink ($T_c = 25^\circ\text{C}$)
	P_{D2}	1.8	W	Stand-alone without heatsink
Junction temperature	T_J	-40 to +150	$^\circ\text{C}$	
Operating temperature	T_{OP}	-40 to +100	$^\circ\text{C}$	
Storage temperature	T_{stg}	-40 to +150	$^\circ\text{C}$	

Electrical Characteristics

($T_a = 25^\circ\text{C}$ unless otherwise specified)

Parameter	Symbol	Ratings			Unit	Conditions
		min	typ	max		
Operating power supply voltage	V_{Bopr}	6.0		30	V	
Quiescent circuit current	I_q		5	12	mA	$V_{Bopr} = 14\text{V}$, $V_{IN} = 0\text{V}$
Saturation voltage of output transistor	$V_{CE(sat)}$			0.3	V	$I_O \leq 1.0\text{A}$, $V_{Bopr} = 6$ to 16V
				0.72	V	$I_O \leq 2.5\text{A}$, $V_{Bopr} = 6$ to 16V
Output leak current	$I_{o, leak}$			2	mA	$V_{CE0} = 16\text{V}$, $V_{IN} = 0\text{V}$
Input voltage	Output ON	V_{IH}	2.0		V	$V_{Bopr} = 6$ to 16V
	Output OFF	V_{IL}	-0.3	0.8	V	$V_{Bopr} = 6$ to 16V
Input current	Output ON	I_{IH}		1	mA	$V_{IN} = 5\text{V}$
	Output OFF	I_{IL}	-0.1		mA	$V_{IN} = 0\text{V}$
Overcurrent protection starting current	I_s	2.6			A	$V_{Bopr} = 14\text{V}$, $V_O = V_{Bopr} - 1.5\text{V}$
Thermal protection starting temperature	T_{TSD}	150			$^\circ\text{C}$	$V_{Bopr} \geq 6\text{V}$
Open load detection resistor	R_{open}			30	$\text{k}\Omega$	$V_{Bopr} = 6$ to 16V
Output transfer time	T_{ON}		8	30	μs	$V_{Bopr} = 14\text{V}$, $I_O = 1\text{A}$
	T_{OFF}		15	30	μs	$V_{Bopr} = 14\text{V}$, $I_O = 1\text{A}$
DIAG output voltage	V_{DH}	4.5		6	V	$V_{CC} = 6\text{V}$, $V_{Bopr} = 6$ to 16V
	V_{DL}			0.3	V	$V_{CC} = 6\text{V}$, $V_{Bopr} = 6$ to 16V , $I_{DO} = 2\text{mA}$
DIAG output transfer time	T_{PLH}			30	μs	$V_{Bopr} = 14\text{V}$, $I_O = 1\text{A}$
	T_{PHL}			30	μs	$V_{Bopr} = 14\text{V}$, $I_O = 1\text{A}$
Minimum load inductance	L	1			mH	

Note:

* The rule of protection against reverse connection of power supply is $V_B = -13\text{V}$, one minute (all terminals except, V_B and GND, are open).

External Dimensions (unit: mm)

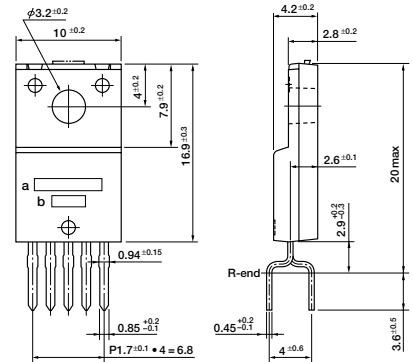

1. GND
 2. V_{IN}
 3. V_O
 4. DIAG
 5. V_B
- a: Part No.
b: Lot No.

(Forming No. 1123)

Standard Circuit Diagram

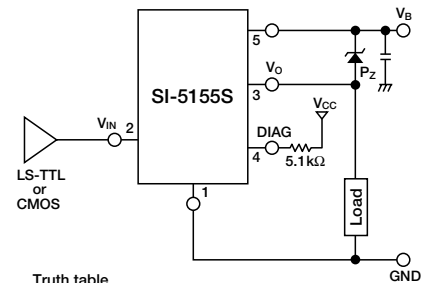

Truth table

V_{IN}	V_O
H	H
L	L

Diagnostic Function

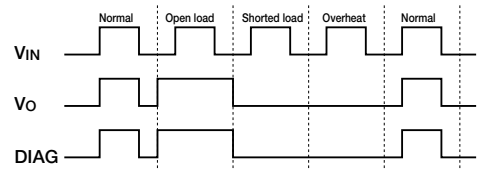

Mode	V_{IN}	V_O	DIAG
Normal	L	L	L
	H	H	H
Open load	L	H	H
	H	H	H
Shorted load	L	L	L
	H	L	L
Overheat	L	L	L
	H	L	L

- DIAG output will be undetermined when a voltage exceeding 25V is applied to V_B terminal.

Electrical Characteristics

■ Quiescent Circuit Current

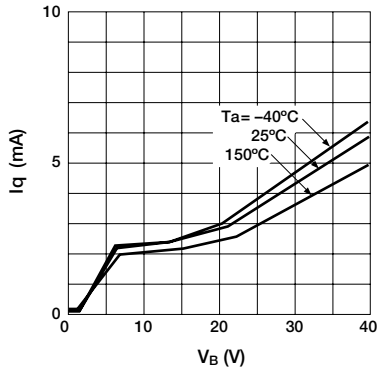

■ Circuit Current

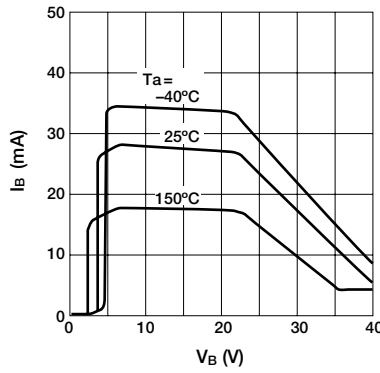

■ Saturation Voltage of Output Transistor

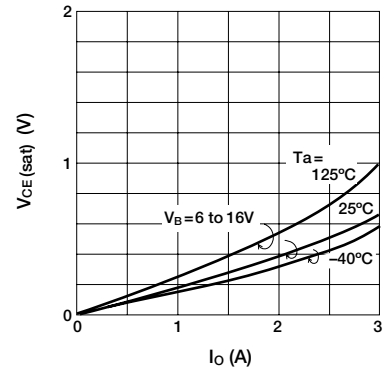

■ Overcurrent Protection Characteristics (Ta = -40°C)

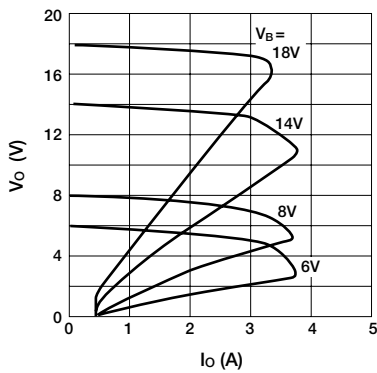

■ Overcurrent Protection Characteristics (Ta = 25°C)

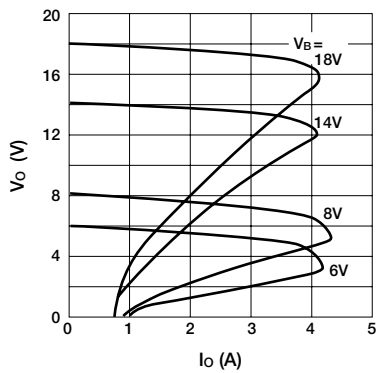

■ Overcurrent Protection Characteristics (Ta = 125°C)

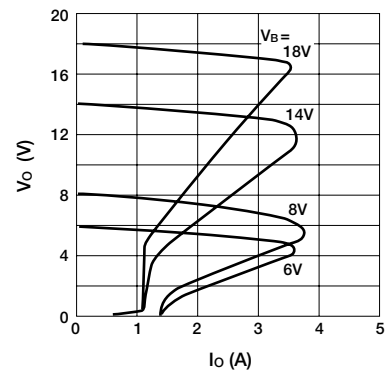

■ Threshold input voltage

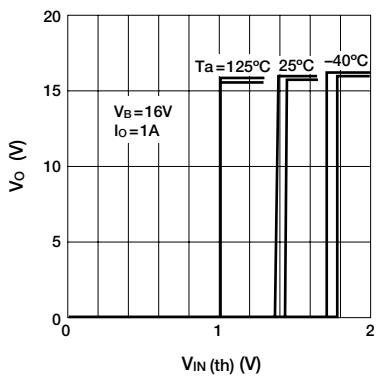

■ Input Current (Output ON)

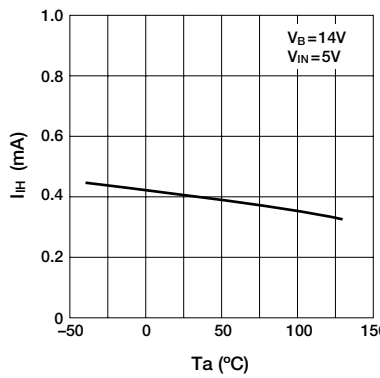

■ Input Current (Output OFF)

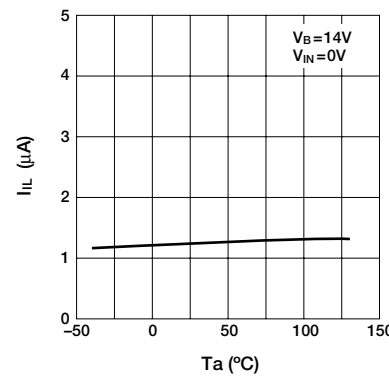

■ Output Terminal Leak Current

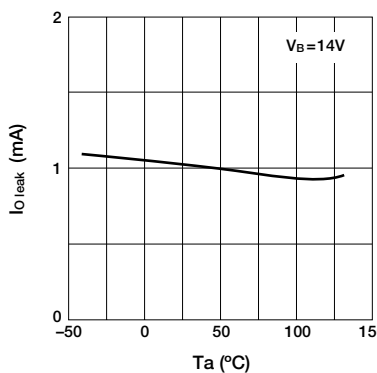

■ Saturation Voltage of DIAG Output

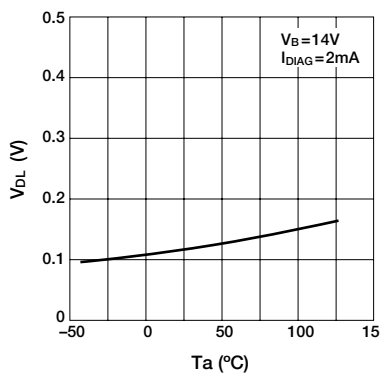

■ Thermal Protection Characteristics

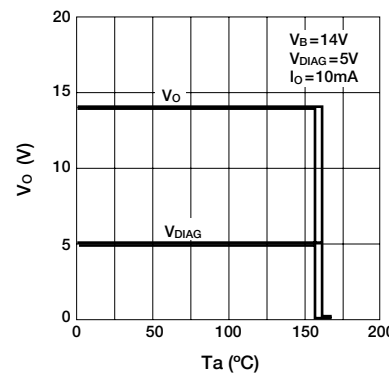

Features

- Built-in diagnostic function to detect short and open circuiting of loads and output status signals
- Low saturation PNP transistor use ($V_{CE(sat)} \leq 0.2V$)
- Allows direct driving using LS-TTL and C-MOS logic levels
- Built-in Zener diode in transistor eliminates the need of (or simplifies) external surge absorption circuit
- Built-in independent overcurrent and thermal protection circuit in each circuit
- Built-in protection against reverse connection of power supply
- $T_j = 150^\circ\text{C}$ guaranteed

Absolute Maximum Ratings

($T_a = 25^\circ\text{C}$)

Parameter	Symbol	Ratings	Unit	Conditions
Power supply voltage	V_B	-13 to +40	V	
Drive terminal applied voltage	V_D	-0.3 to V_B	V	
Input terminal voltage	V_{IN}	-0.3 to +7.0	V	
DIAG output applied voltage	V_{DIAG}	-0.3 to +7.0	V	
DIAG output source current	I_{DIAG}	-3	mA	
Voltage across power supply and output terminal	V_{B-O}	$V_B - 34$	V	
Voltage across power supply and drive terminal	V_{B-D}	-0.4	V	
Output current	I_O	1.5	A	
Output reverse current	I_O	-1.8	A	
Electrostatic resistance	E_S/A	± 250	V	$C = 200\text{pF}$, $R = 0\Omega$
Power Dissipation	P_D	4.8	W	Stand-alone without heatsink, all circuits operating
Junction temperature	T_j	-40 to +150	$^\circ\text{C}$	
Operating temperature	T_{OP}	-40 to +115	$^\circ\text{C}$	
Storage temperature	T_{stg}	-50 to +150	$^\circ\text{C}$	

Electrical Characteristics

($V_{Bopr} = 14V$, $T_j = -40$ to $+150^\circ\text{C}$ unless otherwise specified)

Parameter	Symbol	Ratings			Unit	Conditions	
		min	typ	max			
Operating power supply voltage	V_{Bopr}	6.0		16	V		
Quiescent circuit current (per circuit)	I_q		0.8	1.6	mA	I_O output	
Circuit current (per circuit)	I_B		19.3		mA	$T_j = 25^\circ\text{C}$	
Threshold input voltage	V_{INth}	0.8		3.0	V		
Input voltage	Hi output	V_{IN}	3.7		V		
	Lo output	V_{IN}		1.5	V		
Input current	Hi output	I_{IN}		-1.0	mA	$V_{IN} = 5V$	
	Lo output	I_{IN}	100		μA	$V_{IN} = 0V$	
Saturation voltage of output transistor	$V_{CE(sat)}$			0.2	V	$I_O \leq 1.2A$, $V_{Bopr} = 6$ to $16V$	
	$V_{CE(sat)}$		1.0		V	$I_O \leq 1.5A$, $V_{Bopr} = 6$ to $16V$	
Output terminal sink current	$I_{O(off)}$		2.5	5	mA	$T_j = 25^\circ\text{C}$, $V_{CE0} = 14V$	
Surge clamp voltage	V_{B-O}		29	34	39	V	$T_j = 25^\circ\text{C}$, $I_C = 10\text{mA}$
			28	34	40	V	$I_C = 5\text{mA}$
Saturation voltage of DIAG output	V_{DL}			0.4	V	$I_{DGH} = -2\text{mA}$, $V_{Bopr} = 6$ to $16V$	
Leak current of DIAG output	I_{DGH}			-100	μA	$V_{CC} = 7V$	
Open load detection resistor	R_{open}	5.5			$\text{k}\Omega$		
Overcurrent protection starting current	I_S	1.6			A	$V_O = V_{Bopr} - 1.5V$	
Thermal protection starting temperature	T_{TSD}				$^\circ\text{C}$	$V_{Bopr} \geq 6V$	
Output transfer time	T_{ON}			30	μs	$I_O = 1A$	
	T_{OFF}			100	μs	$I_O = 1A$	
DIAG output transfer time	T_{PLH}			30	μs	$I_O = 1A$	
	T_{PHL}			100	μs	$I_O = 1A$	
Minimum load inductance	L_O	1.0			mH		
Maximum ON duty	$D_{(ON)}$	0		60	%		

Note:

* The Zener diode has an energy capability of 200 mJ (single pulse).

* A start failure may occur if a short OFF signal of 10 ms or below is input in the V_{IN} terminal.

External Dimensions (unit: mm)

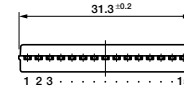
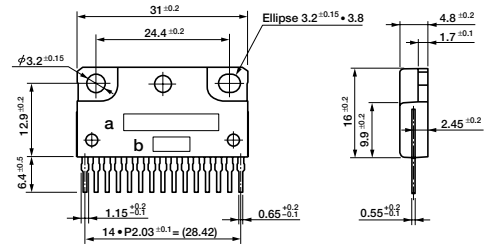

a: Part No.
b: Lot No.

Equivalent Circuit Diagram

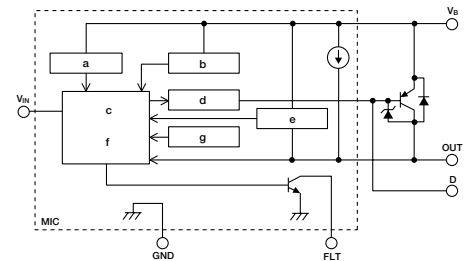

- a: Pre-regulator
- b: Overvoltage protection circuit
- c: Control circuit
- d: Driver circuit
- e: Overcurrent protection circuit
- f: Diagnostic circuit
- g: Thermal protection circuit

Standard Circuit Diagram

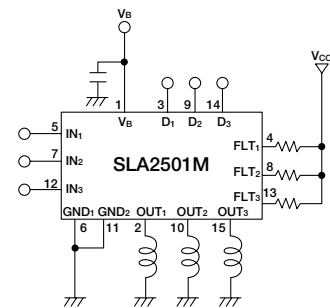

Diagnostic Function

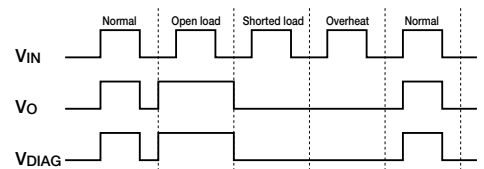

Electrical Characteristics

■ Quiescent Circuit Current (single circuit)

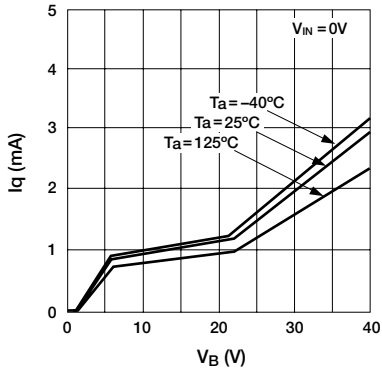

■ Circuit Current (single circuit)

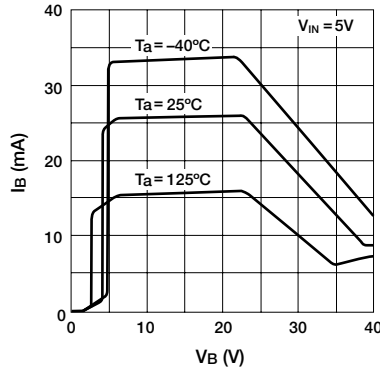

■ Saturation Voltage of Output Transistor

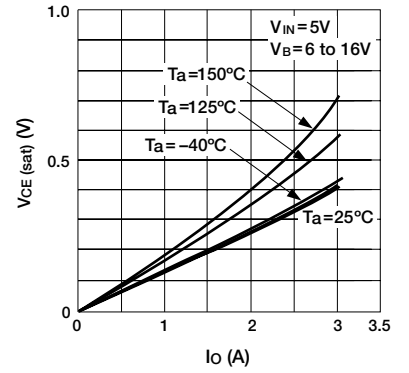

■ Overcurrent Protection Characteristics ($T_a = -40^\circ C$)

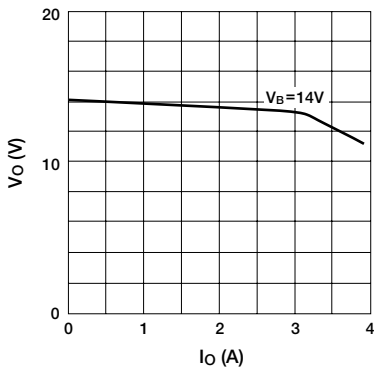

■ Overcurrent Protection Characteristics ($T_a = 25^\circ C$)

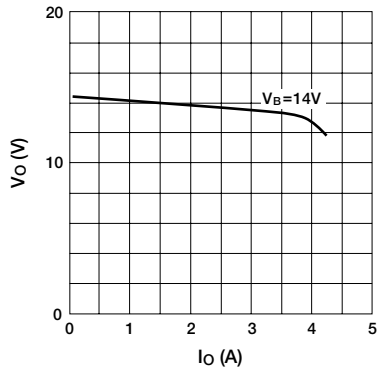

■ Overcurrent Protection Characteristics ($T_a = 125^\circ C$)

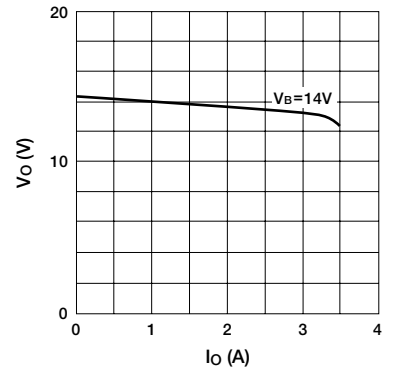

■ Threshold Input Voltage

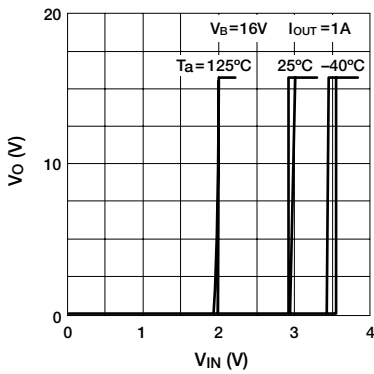

■ Input Current (Output ON)

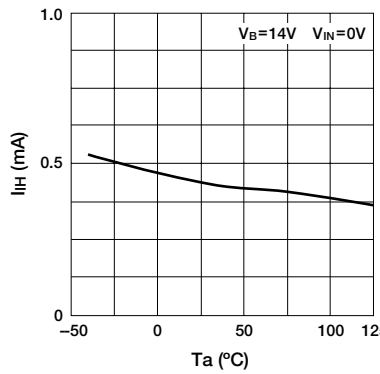

■ Input Current (Output OFF)

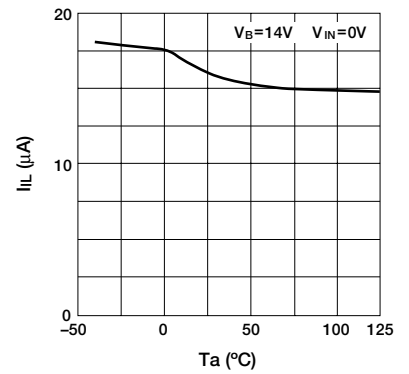

■ Saturation Voltage of DIAG Output

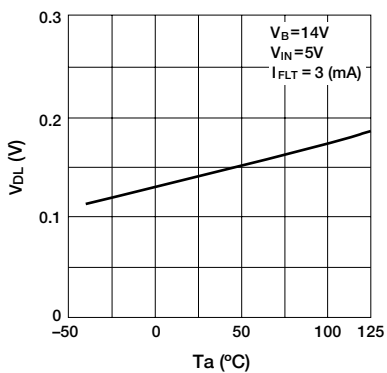

■ Output Reverse Current

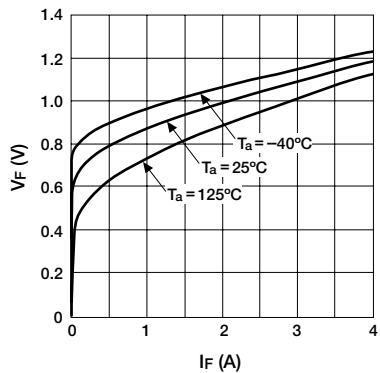

■ Thermal Protection

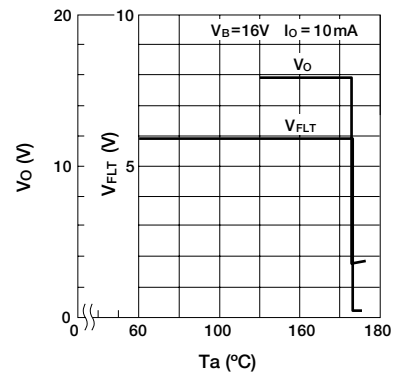

High-side Power Switch ICs [With Diagnostic Function, 4-circuits] SLA2502M

Features

- Built-in diagnostic function to detect short and open circuiting of loads and output status signals
- Low saturation PNP transistor use ($V_{CE(sat)} \leq 0.5V$)
- Allows direct driving using LS-TTL and C-MOS logic levels
- Built-in overcurrent protection circuits
- Built-in protection against reverse connection of power supply
- $T_J = 150^\circ C$ guaranteed

Absolute Maximum Ratings

($T_a = 25^\circ C$)

Parameter	Symbol	Ratings	Unit	Conditions
Power supply voltage	V_B	-13 to +40	V	
Input terminal voltage	V_{IN}	-0.3 to +7.0	V	
DIAG output applied voltage	V_{DIAG}	-0.3 to +7.0	V	
DIAG output source current	I_{DIAG}	3	mA	
Output current	I_O	1.2	A	
Power Dissipation	P_D	4.8	W	Stand-alone operation without heatsink; all circuits operating
Junction temperature	T_J	-40 to +150	$^\circ C$	
Operating temperature	T_{OP}	-40 to +100	$^\circ C$	
Storage temperature	T_{stg}	-50 to +150	$^\circ C$	

Electrical Characteristics

($V_{Bopr} = 14V, T_a = 25^\circ C$ unless otherwise specified)

Parameter	Symbol	Ratings			Unit	Conditions
		min	typ	max		
Operating power supply voltage	V_{Bopr}	6.0		16	V	
Quiescent circuit current (per circuit)	I_q		5	12	mA	$V_{IN} = 0V$
Threshold input voltage	V_{INth}	0.8		3.0	V	
Input current	Hi output	I_{IN}		1.0	mA	$V_{IN} = 5V$
	Lo output	I_{IN}	0	100	μA	$V_{IN} = 0V$
Saturation voltage of output transistor	$V_{CE(sat)}$			0.5	V	$I_O \leq 1.0A, V_{Bopr} = 6$ to 16V
Output terminal sink current	$I_O(off)$			2.0	mA	$V_O = 0V, V_{IN} = 0V$
Saturation voltage of DIAG output	V_{DL}			0.3	V	$I_{DIAG} = 3mA$
Leak current of DIAG output	I_{DGH}			100	μA	$V_{DIAG} = 5V$
Open load detection resistor	R_{open}			30	$k\Omega$	
Overcurrent protection starting current	I_S	1.6			A	$V_O = V_{Bopr} - 1.9V$
	T_{ON}		8	30	μs	$I_O = 1A$
Output transfer time	T_{OFF}		15	30	μs	$I_O = 1A$
	T_{PLH}		10	30	μs	$I_O = 1A$
DIAG output transfer time	T_{PHL}		15	30	μs	$I_O = 1A$

Note: * The rule of protection against reverse connection of power supply is $V_B = -13V$, one minute (all terminals except V_B and GND should be open).

Diagnostic Function

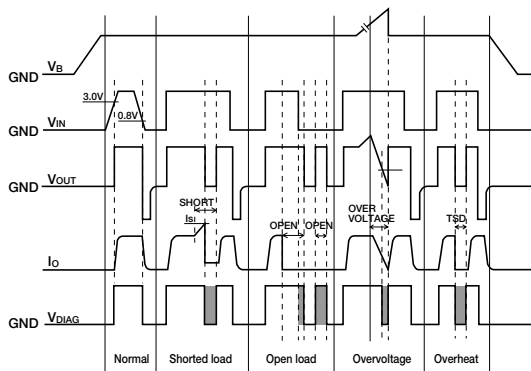

ERROR SIGNAL for CPU

External Dimensions (unit: mm)

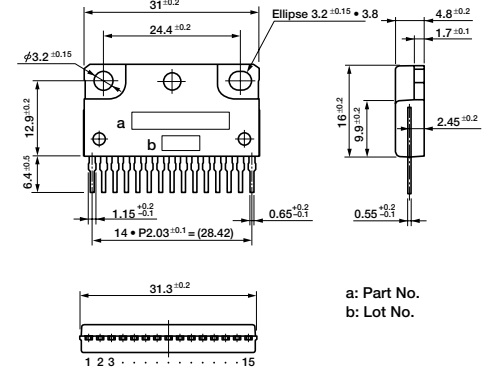

a: Part No.
b: Lot No.

Equivalent Circuit Diagram

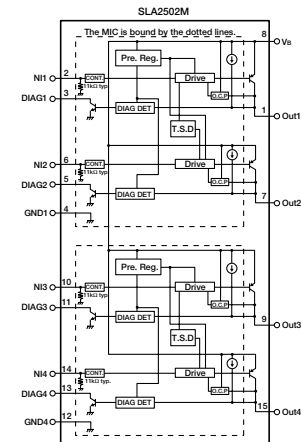

[Abbreviations]

- Drive: Drive circuit
- CONT: ON/OFF circuit
- Pre.Reg: Pre-regulator
- DIAG.DET.: Diagnostic circuit
- O.C.P.: Overcurrent protection
- T.S.D.: Thermal protection

Standard Circuit Diagram

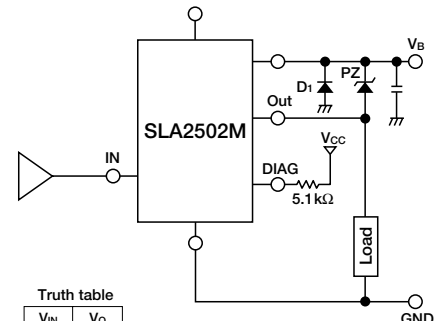

V_{IN}	V_O
H	H
L	L

- Note 1: A pull-down resistor (11kΩ typ.) is connected to the IN terminal. V_{OUT} turns "L" when a high impedance is connected to the IN terminal in series.
- Note 2: Grounds GND1 and GND2 are not wired internally. They must be shorted at a pattern near the product.

Electrical Characteristics

■ Circuit Current (single circuit)

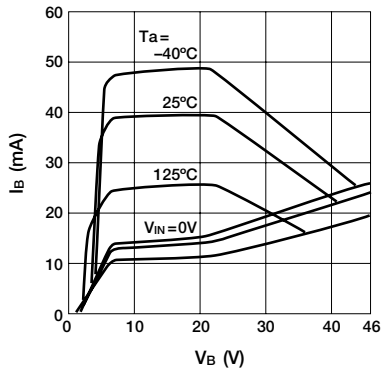

■ Circuit Current (4 circuits)

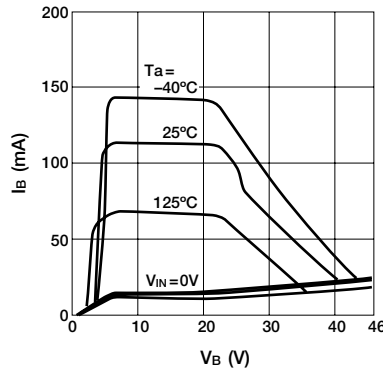

■ Saturation Voltage of Output Transistor (Vb = 14V)

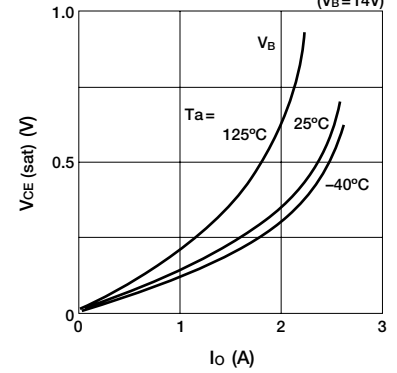

■ Overcurrent Protection Characteristics (Ta = -40°C)

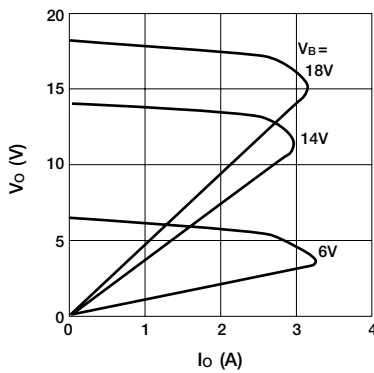

■ Threshold Input Voltage

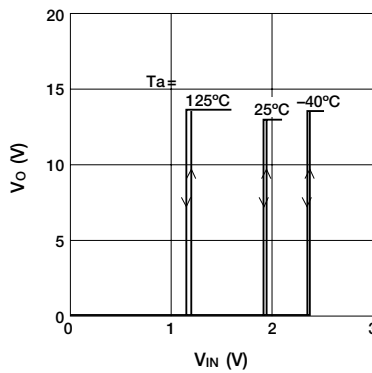

■ Input Current (Output OFF)

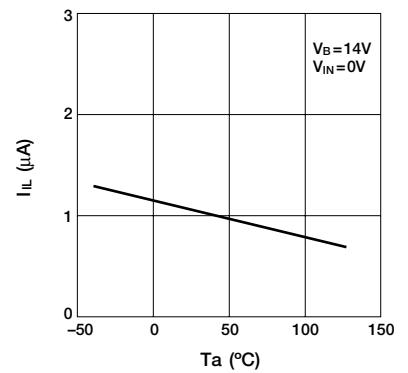

■ Input Current (Output Hi)

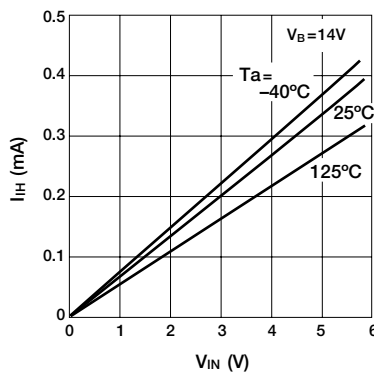

■ Saturation Voltage of DIAG Output

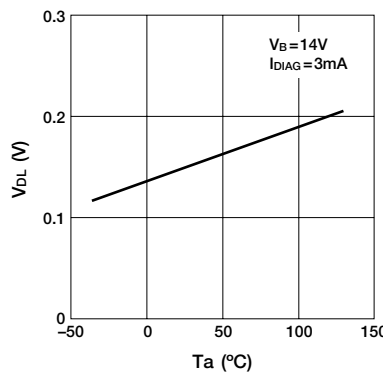

■ Quiescent Circuit Current (dual circuit)

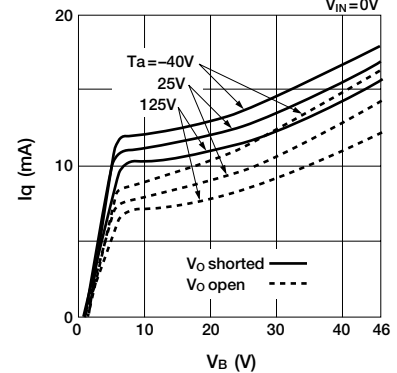

■ Thermal Protection Characteristics

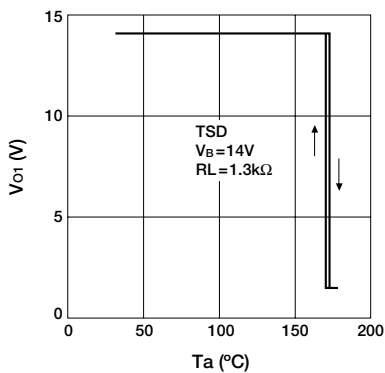

■ Output Terminal Leak Current (Vo = 0V)

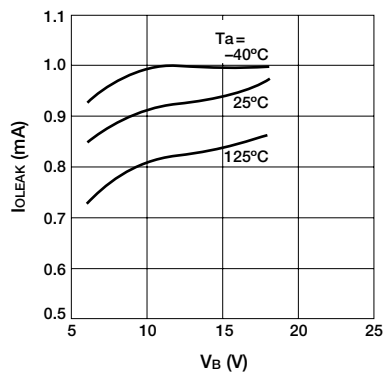

■ Open Load Detection Resistor

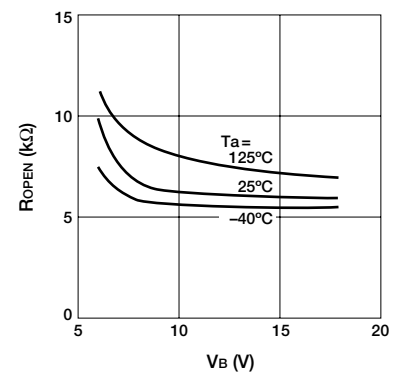

High-side Power Switch ICs [With Diagnostic Function, Surface-mount 2-circuits] **SPF5003**

Features

- Built-in diagnostic function to detect short and open circuiting of loads and output status signals
- DMOS 2ch output
- Allows ON/OFF using C-MOS logic level
- Built-in overcurrent and thermal protection circuits

Absolute Maximum Ratings

(Ta=25°C)

Parameter	Symbol	Ratings	Unit	Conditions
Power supply voltage	V _B	35	V	
Input terminal voltage	V _{IN}	-0.3 to 7	V	
Input terminal current	I _{IN}	5	mA	
DG terminal voltage	V _{DG}	-0.3 to 7	V	
DG terminal current	I _{DG}	5	mA	
Drain to source voltage	V _{DS}	V _B -45	V	
Output current	I _O	1.8	A	
Power dissipation	P _D	2	W	Ta=25°C
Source to drain Di forward current	I _F	0.8	A	
Channel temperature	T _{ch}	150	°C	
Operating temperature	T _{OP}	-40 to +105	°C	
Storage temperature	T _{stg}	-40 to +150	°C	

Electrical Characteristics

(V_B=14V, Ta=25°C unless otherwise specified)

Parameter	Symbol	Ratings			Unit	Conditions	
		min	typ	max			
Operating power supply voltage	V _{B (opr)}	5.5		35	V		
Quiescent circuit current	I _q			1	mA	V _{IN} =0V, V _{OUT} =0V	
Output ON resistance	R _{DS (ON)}			200	mΩ	I _O =1A	
				300	mΩ	I _O =1A, Ta=80°C	
Output leak current	I _{o, leak}		50	100	μA	V _{OUT} =0V	
Input threshold voltage	Output ON	V _{IHth}	1.4	2.0	3.0	V	Ta= -40 to +105°C
	Output OFF	V _{ILth}	1.0	1.8		V	Ta= -40 to +105°C
Input current	Output ON	I _{IH}		70	200	μA	V _{IN} =5V
	Output OFF	I _{IL}			12	μA	V _{IN} =0V
Overcurrent protection starting current	I _s	1.9	3		A	V _{OUT} =V _O -1.5V	
Internal current limit	I _{Lim}		5		A	V _{OUT} =0V	
Thermal shutdown operating temperature	T _{TSD}	155	165		°C		
Load open detection threshold voltage	V _{open}	1.5	3	4.5	V		
Output transfer time	*1	T _{ON}	70	140		μs	R _L =14Ω, V _O =-5V
		T _{OFF}	35	90		μs	R _L =14Ω, V _O *10%
DG leak current	I _{DG}			20	μA	V _{DG} =5.5V	
Low level DG output voltage	V _{DGL}		0.15	0.5	V	I _{DG} =1.6mA	
DG output transfer time	*1	T _{PLH}	70	140		μs	
		T _{PHL}	45	120		μs	

Note: *1. Transient time is showed Wave Form below.

Recommended Operating Conditions (for one channel)

Parameter	Ratings		Unit
	min	max	
Power supply voltage	5.5	16	V
V _{IH}	4	5.5	V
V _{IL}	-0.3	0.9	V
I _O		1	A
R _{IN}	10	20	kΩ
R _{DG}	10	20	kΩ

Wave Form

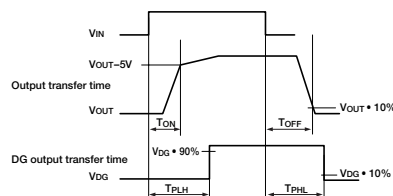

External Dimensions (unit: mm)

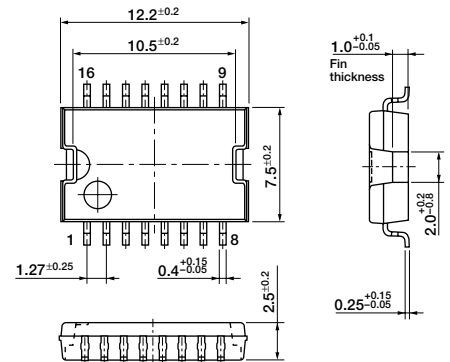

Block Diagram (for one channel)

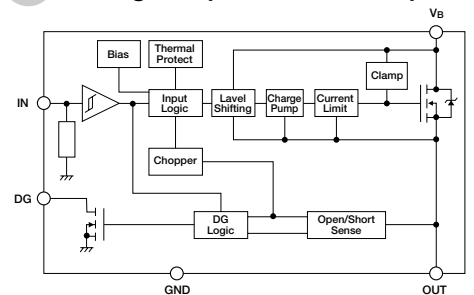

Standard Connection Diagram

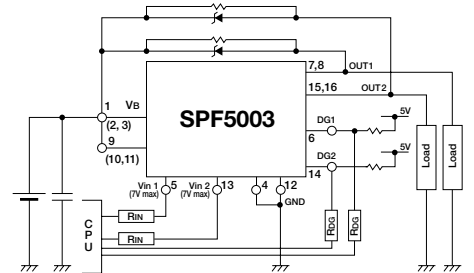

* R_{IN} and R_{DG} are needed to protect CPU and SPF5003 in case of reverse connection of V_B terminal.
* Make V_B of 1Pin and 9Pin short from the fin to be plated by solder.

Timing Chart

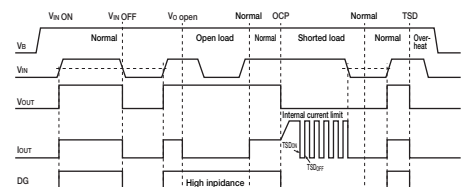

Mode	V _{IN}	DG	V _O
Normal	H	L	H
	L	L	L
Open load	H	H	H
	L	L	L
Shorted load	H	L	L (Limiting)
	L	L	L
Overheat	H	L	L
	L	L	L

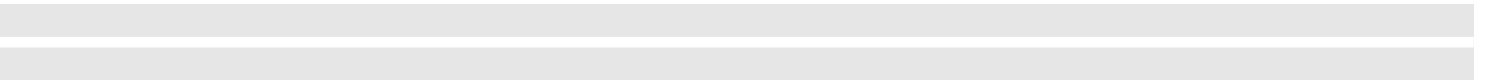

High-side Power Switch ICs [With Diagnostic Function, Surface-mount 2-circuits] **SPF5004**

Features

- Built-in diagnostic function to detect short and open circuiting of loads and output status signals
- DMOS 2ch output
- Allows ON/OFF using C-MOS logic level
- Built-in overcurrent and thermal protection circuits

Absolute Maximum Ratings

(Ta=25°C)

Parameter	Symbol	Ratings	Unit	Conditions
Power supply voltage	V _B	35	V	
Input terminal voltage	V _{IN}	-0.3 to 7	V	
Input terminal current	I _{IN}	5	mA	
DG terminal voltage	V _{DG}	-0.3 to 7	V	
DG terminal current	I _{DG}	5	mA	
Drain to source voltage	V _{DS}	V _B -45	V	
Output current	I _O	2.5	A	
Power dissipation	P _D	2.7	W	Ta=25°C
Source to drain Di forward current	I _F	0.8	A	
Channel temperature	T _{ch}	150	°C	
Operating temperature	T _{OP}	-40 to +105	°C	
Storage temperature	T _{stg}	-40 to +150	°C	

Electrical Characteristics

(V_B=14V, Ta=25°C unless otherwise specified)

Parameter	Symbol	Ratings			Unit	Conditions
		min	typ	max		
Operating power supply voltage	V _{B (opr)}	5.5		35	V	
Quiescent circuit current	I _q			1	mA	V _{IN} =0V, V _{OUT} =0V
Output ON resistance	R _{DS (ON)}			150	mΩ	I _O =2A
				250	mΩ	I _O =1A, Ta=80°C
Output leak current	I _{O, leak}		50		μA	V _{OUT} =0V
Input voltage	Output ON	V _{IH}	2.0	3.0	V	Ta=-40 to +105°C
	Output OFF	V _{IL}	1.0	1.8	V	Ta=-40 to +105°C
Input current	Output ON	I _{IH}		70	μA	V _{IN} =5V
Overcurrent protection starting current	I _s	2.6			A	V _{OUT} =V _O -1.5V
Internal current limit	I _{Lim}		10		A	V _{OUT} =0V
Thermal shutdown operating temperature	T _{TSD}	155	165		°C	
Load open detection threshold voltage	V _{open}		3		V	
Output transfer time	T _{ON}		165		μs	
	T _{OFF}		60		μs	
DG leak current	I _{DG}			20	μA	V _{DG} =5.5V
Low level DG output voltage	V _{DGL}		0.15		V	I _{DG} =1.6mA
DG output transfer time	T _{PLH}		70		μs	
	T _{PHL}		45		μs	

Recommended Operating Conditions (for one channel)

Parameter	Ratings		Unit
	min	max	
Power supply voltage	5.5	16	V
V _{IH}	4	5.5	V
V _{IL}	-0.3	0.9	V
I _O		1.15	A
R _{IN}	10	20	kΩ
R _{DG}	10	20	kΩ

External Dimensions (unit: mm)

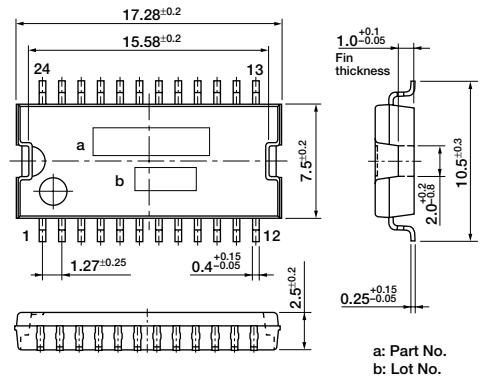

a: Part No.
b: Lot No.

Block Diagram (for one channel)

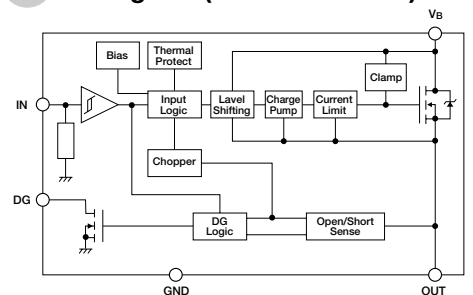

Standard Connection Diagram

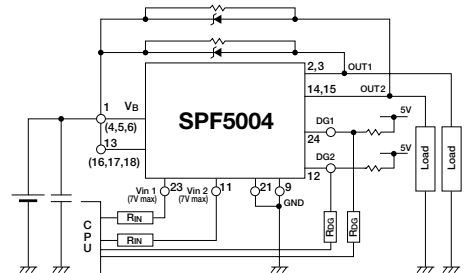

* Make V_b of 4Pin, 5Pin, 6Pin, 16Pin, 17Pin and 18Pin short from the fin to be plated by solder.

Timing Chart

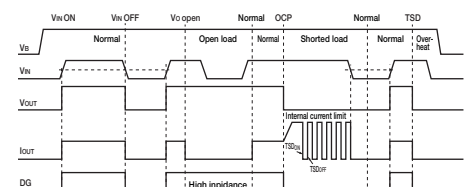

Mode	V _{IN}	DG	V _O
Normal	H	H	H
	L	L	L
Open load	H	H	H
	L	H	H
Shorted load	H	L	L (Limiting)
	L	L	L
Overheat	H	L	L
	L	L	L



High-side Power Switch ICs [With Diagnostic Function, Surface-mount 3-circuits] **SPF5007**

Features

- Built-in diagnostic function to detect short and open circuiting of loads and output status signals
- DMOS 3ch output
- Allows ON/OFF using C-MOS logic level
- Built-in overcurrent and thermal protection circuits

Absolute Maximum Ratings

(Ta=25°C)

Parameter	Symbol	Ratings	Unit	Conditions
Power supply voltage	V _B	35	V	
Input terminal voltage	V _{IN}	-0.3 to 7	V	
Input terminal current	I _{IN}	5	mA	
DG terminal voltage	V _{DG}	-0.3 to 7	V	
DG terminal current	I _{DG}	5	mA	
Drain to source voltage	V _{DS}	V _B -45	V	
Output current	I _O	1.8	A	
Power dissipation	P _D	2.7	W	Ta=25°C, all circuit operating
Source to drain Di forward current	I _F	0.8	A	
Channel temperature	T _{ch}	150	°C	
Operating temperature	T _{OP}	-40 to +105	°C	
Storage temperature	T _{stg}	-40 to +150	°C	

Electrical Characteristics

(V_B=14V, Ta=25°C unless otherwise specified)

Parameter	Symbol	Ratings			Unit	Conditions	
		min	typ	max			
Operating power supply voltage	V _{B (opr)}	5.5		35	V		
Quiescent circuit current	I _q			1	mA	V _{IN} =0V, V _{OUT} =0V	
Output ON resistance	R _{DS (ON)}			200	mΩ	I _O =1A	
				350	mΩ	I _O =1A, Ta=80°C	
Output leak current	I _{O, leak}		50	100	μA	V _{OUT} =0V	
Input threshold voltage	Output ON	V _{IHth}	1.4	2.0	3.0	V	Ta=-40 to +105°C
	Output OFF	V _{ILth}	1.0	1.8		V	Ta=-40 to +105°C
Input current	Output ON	I _{IH}		70	200	μA	V _{IN} =5V
	Output OFF	I _{IL}			12	μA	V _{IN} =0V
Overcurrent protection starting current	I _s	1.9	3		A	V _{OUT} =V _O -1.5V	
Internal current limit	I _{lim}		5		A	V _{OUT} =0V	
Thermal shutdown operating temperature	T _{TSD}	155	165		°C		
Load open detection threshold voltage	V _{open}	1.5	3	4.5	V		
Output transfer time	T _{ON}		70	140	μs	R _L =14Ω, V _{OUT} =V _B -5V	
	T _{OFF}		35	90	μs	R _L =14Ω, V _B +10%	
DG leak current	I _{DG}			20	μA	V _{DG} =5.5V	
Low level DG output voltage	V _{DGL}		0.15	0.5	V	I _{DG} =1.6mA	
DG output transfer time	T _{PLH}		70	140	μs		
	T _{PHL}		45	120	μs		

Recommended Operating Conditions (for one channel)

Parameter	Ratings		Unit
	min	max	
Power supply voltage	5.5	16	V
V _{IH}	4	5.5	V
V _{IL}	-0.3	0.9	V
I _O		1	A
R _{IN}	10	20	kΩ
R _{DG}	10	20	kΩ

External Dimensions (unit: mm)

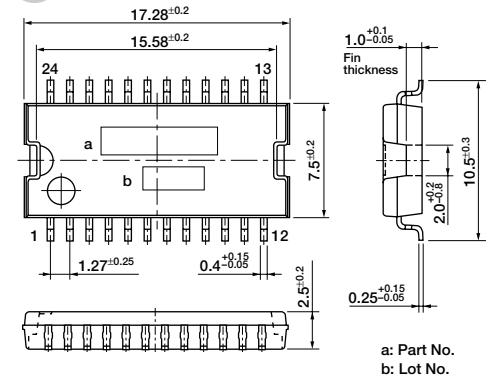

Block Diagram (for one channel)

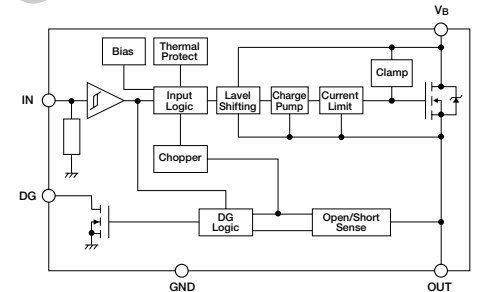

Standard Connection Diagram

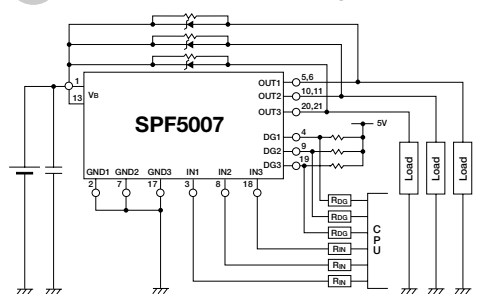

- * R_{IN} and R_{DG} are needed to protect CPU and SPF5007 in case of reverse connection of V_B terminal.
- * Make V_B of 1Pin and 13Pin short from the fin to be plated by solder.

Timing Chart

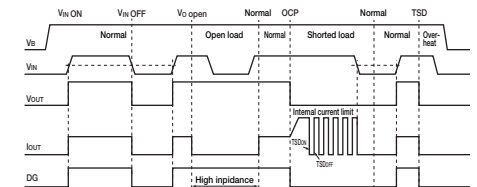

Mode	V _{IN}	DG	V _O
Normal	H	H	H
	L	L	L
Open load	H	H	H
	L	L	L
Shorted load	H	L	L (Limiting)
	L	L	L
Overheat	H	L	L
	L	L	L



High-side Power Switch ICs [Surface-mount 2-circuit, current monitor output function] **SPF5017**

Features

- Internal current sense resistor
- High accuracy current monitor output (sample & hold function)
- Built-in overcurrent and thermal protection circuits

Absolute Maximum Ratings

(Ta=25°C)

Parameter	Symbol	Ratings	Unit	Conditions
Power supply voltage 1	V _B	0 to 32	V	
Power supply voltage 2	V _{CC}	-0.5 to 7.0	V	
Power supply voltage 3	V _B	0 to 40	V	V _B terminal, t = 1 min
Current sensing voltage	V _{sense} ⁺	-0.8 to 6	V	
	V _{sense} ⁻	V _{sense} ⁺ ± I _o • R _{sense}		
Output terminal voltage	V _{OUT}	-2 to 32	V	
Input terminal voltage	V _{PWM}	-0.5 to 7.0	V	
	V _{Hold}			
Output current	I _{OUT}	2.0	A	
Power dissipation	P _D	2.4 to 5.0	W	Depends on surface-mount board pattern
Storage temperature	T _{stg}	-40 to +150	°C	
Channel temperature	T _{ch}	150	°C	

Electrical Characteristics

(V_B=14V, Ta=25°C unless otherwise specified) – One circuit equivalent

Parameter	Symbol	Ratings			Unit	Conditions	
		min	typ	max			
Min. operating power supply voltage	V _B min	6			V	Minimum operation of OUT terminal.	
Operating power supply voltage 1	V _B	10	14	16	V	*1	
Operating power supply voltage 2	V _{CC}		5.0		V	*2	
Quiescent circuit current 1	I _{qvb}			7.2	mA	V _{CC} =5V, V _{PWM} =0V, One circuit equivalent	
Quiescent circuit current 2	I _{qvcc}			0.2	mA	V _{CC} =5V, V _{PWM} =0V	
PWM terminal input voltage	V _{PWMH}	3.5			V	V _{CC} =5V	
	V _{PWML}			1.5			
PWM terminal input current	I _{PWMH}		70	110	μA	V _{CC} =5V, V _{PWM} =5V, Active H *3	
	I _{PWML}						
Hold terminal input voltage	V _{HoldH}	3.5			V	V _{CC} =5V	
	V _{HoldL}			1.5			
Hold terminal input current	I _{HoldH}		70	110	μA	V _{CC} =5V, V _{PWM} =5V, Active H *3	
	I _{HoldL}						
Output ON resistance	R _{DSon}			0.14	Ω	I _{OUT} =1A	
				0.21			
Current sensing resistance	R _{sense}			0.21	Ω	I _{OUT} =1A	
				0.25			
Overcurrent protection starting current	I _s	3.0			A	*4	
Thermal shutdown operating temperature	T _{tsd}				°C		
Operation circuit for current monitor output	I _o			0.2	V	I _o =0A, V _{CC} =5V	
			0.488	0.500			0.512
			1.219	1.250			1.281
			2.925	3.000			3.075
Current monitor output voltage	V _{SH}			0.2	V	I _o =0.2A, V _{CC} =5V	
Current monitor output current	I _{SH}			5	mA	I _o =1A, V _{CC} =5V, V _{SH} =0V	
Output transfer time	t _{on}			15	μs	I _o =0.5A, V _{CC} =5V	
Output rise time	t _r			100	μs		
Output fall time	t _f			50	μs		
Current monitor output hold time	t _{sh}	500		650	μs		
Current monitor output delay time	t _{shd}			1	μs	I _o =0.5A, V _{CC} =5V, C ₁ =0.033μF	
Hold time after inputting hold	t _{shh}			2	μs		
S/H settling time	t _{stt}			70	μs	V _B =11V, V _{CC} =5V, I _o =1.2A, C ₁ =0.033μF	
				80			

Note:

- *1: Accuracy warranty range for current monitor output
- *2: Equivalent errors are not included in current monitor output accuracy.
- *3: With built-in pull-down resistance (70kΩ typ)
- *4: Self-excitation and oscillation type
- *5: Accuracy of current monitor output is affected by the materials of the hold capacitor (C₁). The capacitor C₁ must be of low dielectric absorption and have good bias and leak current characteristics.

External Dimensions (unit: mm)

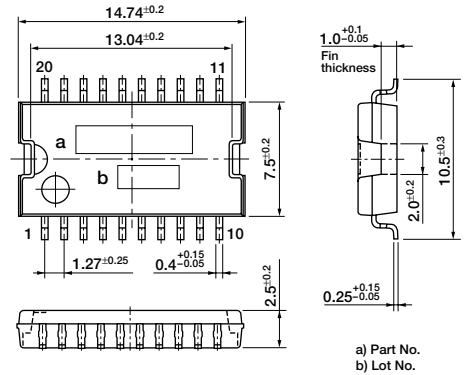

Block Diagram (for one channel)

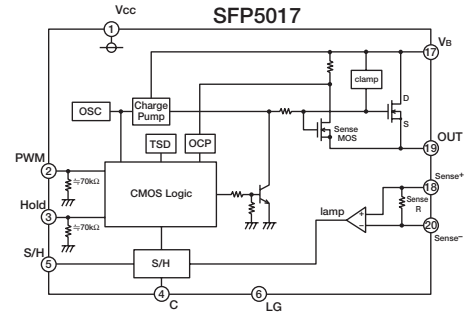

Standard Connection Diagram

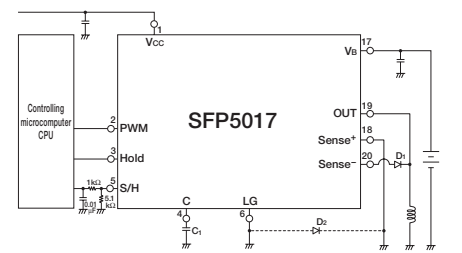

* Use a Schottky Di for D2 when the Sense* terminal is lower than the abs. max. rated voltage (-0.8V)

Timing Chart

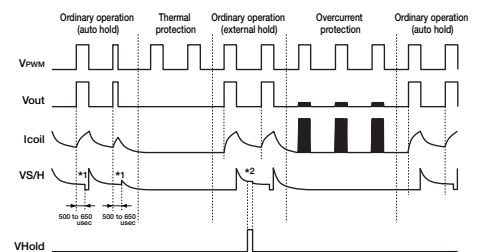

Truth table

V _{PWM}	L	H
V _{OUT}	L	H



High-side Power Switch ICs [Surface-mount, current monitor output function] **SPF5018**

Features

- Internal current sense resistor
- High accuracy current monitor output (sample & hold function)
- Built-in overcurrent and thermal protection circuits

Absolute Maximum Ratings

(Ta=25°C)

Parameter	Symbol	Ratings	Unit	Conditions
Power supply voltage 1	V _B	0 to 32	V	
Power supply voltage 2	V _{CC}	-0.5 to 7.0	V	
Power supply voltage 3	V _B	0 to 40	V	V _B terminal, t = 1 min
Current sensing voltage	V _{sense} ⁺	-0.8 to 6	V	
	V _{sense} ⁻	V _{sense} ⁺ ± I _o • R _{sense}		
Output terminal voltage	V _{OUT}	-2 to 32	V	
Input terminal voltage	V _{PWM}	-0.5 to 7.0	V	
	V _{Hold}			
Output current	I _{OUT}	2.0	A	
Power dissipation	P _D	2.0	W	Depends on surface-mount board pattern
Storage temperature	T _{stg}	-40 to +150	°C	
Channel temperature	T _{ch}	150	°C	

Electrical Characteristics

(V_B=14V, Ta=25°C unless otherwise specified)

Parameter	Symbol	Ratings			Unit	Conditions
		min	typ	max		
Min. operating power supply voltage	V _B min	6			V	Minimum operation of OUT terminal.
Operating power supply voltage 1	V _B	10	14	16	V	*1
Operating power supply voltage 2	V _{CC}		5.0		V	*2
Quiescent circuit current 1	I _{qvb}			7.2	mA	V _{CC} =5V, V _{PWM} =0V
Quiescent circuit current 2	I _{qvcc}			0.2	mA	V _{CC} =5V, V _{PWM} =0V
PWM terminal input voltage	V _{PWMH}	3.5			V	V _{CC} =5V
	V _{PWML}			1.5		
PWM terminal input current	I _{PWMH}		70	110	μA	V _{CC} =5V, V _{PWM} =5V, Active H *3
	I _{PWML}					
Hold terminal input voltage	V _{HoldH}	3.5			V	V _{CC} =5V
	V _{HoldL}			1.5		
Hold terminal input current	I _{HoldH}		70	110	μA	V _{CC} =5V, V _{PWM} =5V, Active H *3
	I _{HoldL}					
Output ON resistance	R _{DSon}			0.14	Ω	I _{OUT} =1A
				0.21		
Current sensing resistance	R _{sense}			0.21	Ω	I _{OUT} =1A
				0.25		
Overcurrent protection starting current	I _s	3.0			A	*4
Thermal shutdown operating temperature	T _{tsd}	150			°C	
Operation circuit for current monitor output	I _o	0.2		1.2	A	*1
Current monitor output voltage	V _{SH}			0.2	V	I _o =0A, V _{CC} =5V
		0.488	0.500	0.512	V	I _o =0.2A, V _{CC} =5V
		1.219	1.250	1.281	V	I _o =0.5A, V _{CC} =5V, Ta=-40 to 140°C
		2.925	3.000	3.075	V	I _o =1.2A, V _{CC} =5V, Ta=-40 to 140°C
Current monitor output current	I _{SH}			5	mA	I _o =1A, V _{CC} =5V, V _{SH} =0V
		-6			mA	I _o =1A, V _{CC} =5V, V _{SH} =5V
Output transfer time	t _{on}			15	μs	I _o =0.5A, V _{CC} =5V
	t _{off}			15		
Output rise time	t _r			100	μs	
Output fall time	t _f			50	μs	
Current monitor output hold time	t _{sh}	500		650	μs	
Current monitor output delay time	t _{shd}			1	μs	I _o =0.5A, V _{CC} =5V, C1=0.033μF
Hold time after inputting hold	t _{shh}			2	μs	
S/H settling time	t _{stt}			70	μs	V _B =11V, V _{CC} =5V, I _o =1.2A, C1=0.033μF
				80	μs	V _B =11V, V _{CC} =5V, I _o =1.2A, C1=0.033μF, Ta=125°C

Note:

- *1: Accuracy warranty range for current monitor output
- *2: Equivalent errors are not included in current monitor output accuracy.
- *3: With built-in pull-down resistance (70kΩ typ)
- *4: Self-excitation and oscillation type
- *5: Accuracy of current monitor output is affected by the materials of the hold capacitor (C1). The capacitor C1 must be of low dielectric absorption and have good bias and leak current characteristics.

External Dimensions (unit: mm)

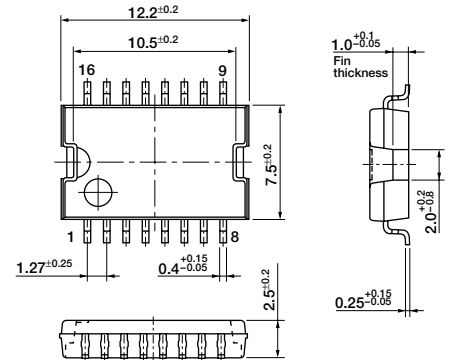

Block Diagram (for one channel)

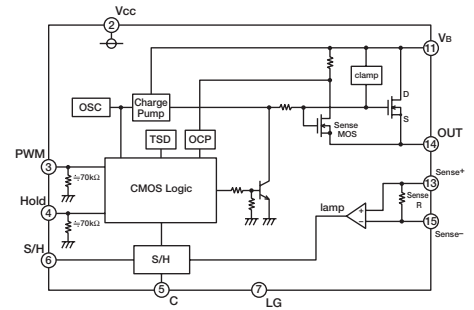

Standard Connection Diagram

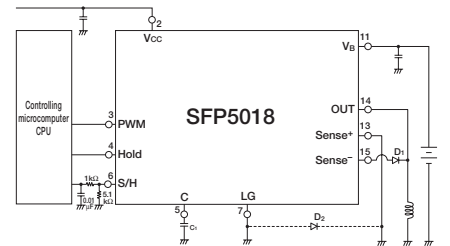

* Use a Schottky Di for D2 when the Sense* terminal is lower than the abs. max. rated voltage (-0.5V)

Timing Chart

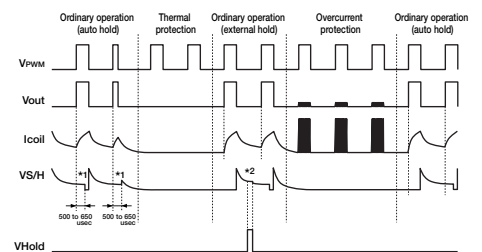

Truth table

V _{PWM}	L	H
V _{OUT}	L	H



Electrical Characteristics

■ Quiescent Circuit Current

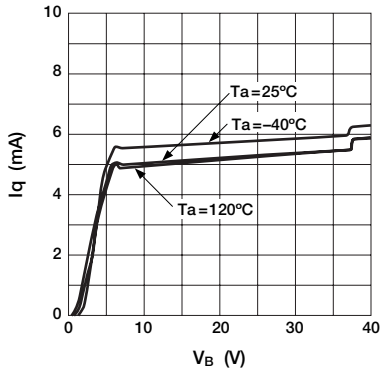

■ Circuit Current (single circuit)

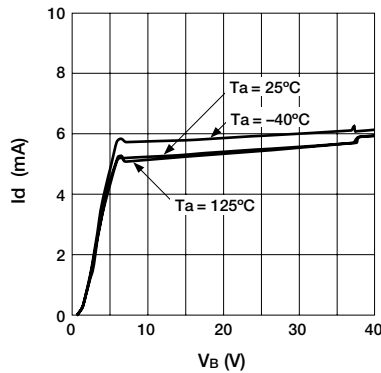

■ Circuit Current (4 circuits)

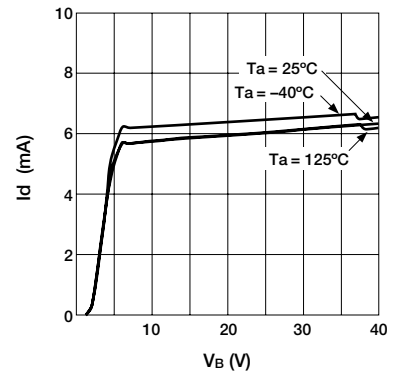

■ Threshold Input Voltage

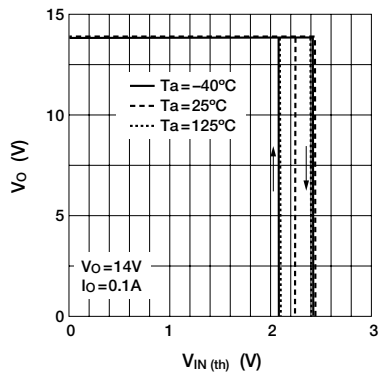

■ Output ON Voltage

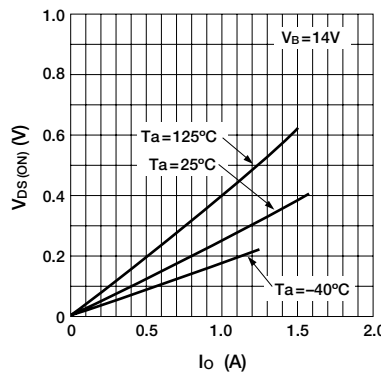

■ Forward Voltage of Output Stage Diode

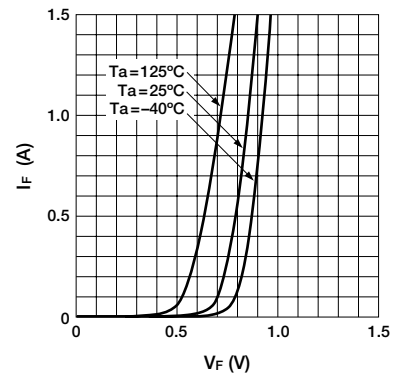

■ Overcurrent Protection Characteristics

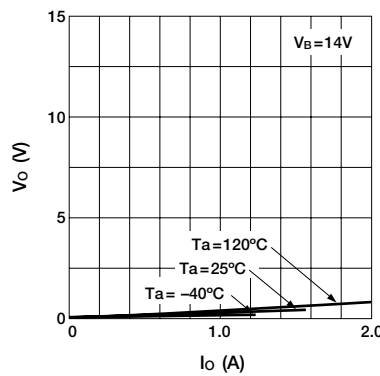

■ Overvoltage Protection Starting Voltage

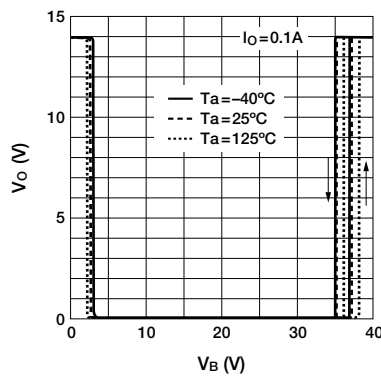

Features

- DMOS 4ch output
- Allows ON/OFF using C-MOS logic level
- Built-in over current and thermal protection circuit and diagnostic function to detect open load
- Built-in output status signals (over current, over heat and open load)

Absolute Maximum Ratings

(Ta=25°C)

Parameter	Symbol	Ratings	Unit	Conditions
Power supply voltage	V _B	40	V	
Output terminal voltage (DC)	V _{OUT}	50	V	
Output terminal voltage (pulse)	V _{OUT}	Output clamping (max 70V)	V	
Output current (DC)	I _{OUT}	±2.9	A	
Output current (pulse)	I _{OUT}	Over current protection starting current	A	
Input terminal voltage	V _(IN,SEL,B/U)	-0.5 to +6.5	V	
Diag output source current	V _{DIAG}	6.5	V	
Diag output voltage	I _{DIAG}	5	mA	
Power Dissipation	P _D	2.8	W	
Storage temperature	T _{stg}	-40 to +150	°C	
Channel temperature	T _{ch}	150	°C	
Output avalanche capability	E _{AV}	80	mJ	Single pulse

Electrical Characteristics

(V_B=14V, Ta= 25°C unless otherwise specified)

Parameter	Symbol	Ratings			Unit	Conditions
		min	typ	max		
Power supply voltage	V _{B (opr)}	5.5		40	V	
Quiescent circuit current	I _q		9	12	mA	V _B =14V, V _{IN} =0V
Operating circuit current	I _d		12	15	mA	V _B =14V, V _{IN} =5V (all inputs)
Input voltage (1 to 4, SEL, B/U)	V _{IN (H)}	3.5		6.5	V	V _B =14V, V _O =1A
	V _{IN (L)}	-0.5		1.5	V	V _B =14V
Input current (single circuit) (1 to 4, SEL, B/U)	I _{IN (H)}			200	µA	V _B =14V, V _{IN} =5V
	I _{IN (L)}			30	µA	V _B =14V, V _{IN} =0V
Output ON resistance	R _{DS (ON)}			0.18	Ω	V _B =14V, I _O =1A
Output clamp voltage	V _{OUT (clamp)}	60	65	70	V	V _B =14V, I _O =1A
Output leak current	I _{OH}			50	µA	V _B =14V, V _O =50V
Forward voltage of output stage diode	V _F			1.5	V	I _F =1A
Output monitor threshold voltage	V _{thM}			2	V	V _B =14V
DIAG output voltage	V _{DIAG (H)}	6.4		6.5	V	V _B =14V, I _{DIAG} =6.5V
	V _{DIAG (L)}			0.5	V	V _B =14V, I _{DIAG} =5mA
DIAG output leak current	I _{DH}			10	µA	V _B =14V, V _{DIAG} =6.5V
Thermal shutdown operating temperature	T _{TSD}	151	165		°C	V _B =14V
Overcurrent protection starting current	I _S	3.0			A	V _B =14V
Output transfer time	T _{ON}			12	µs	V _B =14V, R _L =14Ω, I _O =1A
	T _{OFF}			8	µs	V _B =14V, R _L =14Ω, I _O =1A
Output rise time	T _r			5	µs	V _B =14V, R _L =14Ω, I _O =1A
Output fall time	T _f			10	µs	V _B =14V, R _L =14Ω, I _O =1A
DIAG output transfer time	t _{DON}			12	µs	V _B =14V, R _L =14Ω, I _O =1A
	t _{DOFF}			8	µs	V _B =14V, R _L =14Ω, I _O =1A

External Dimensions (unit: mm)

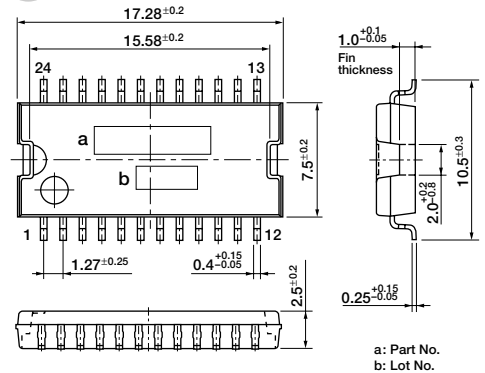

Equivalent Circuit Diagram

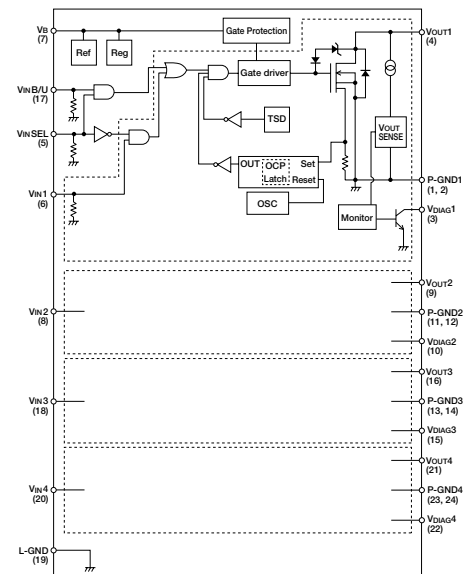

Circuit Example

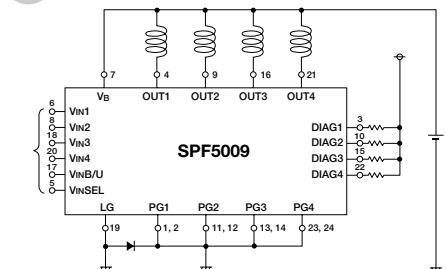

Timing Chart

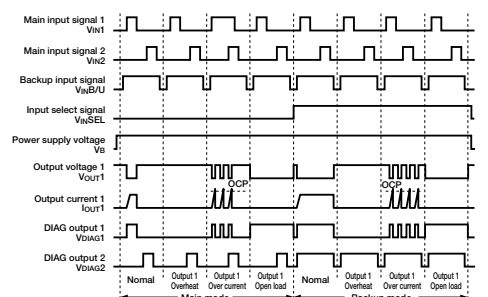



Low-side Switch ICs [Surface-mount 4-circuits with Output Monitor] **SPF5012**

Features

- Output monitor circuit (DIAG)
- DMOS 4ch output
- Allows ON/OFF using C-MOS logic level
- Built-in overcurrent, overvoltage and thermal protection circuits

Absolute Maximum Ratings

(Ta=25°C)

Parameter	Symbol	Ratings	Unit	Conditions
Power supply voltage 1	V _B	40	V	
Power supply voltage 2	V _{CC}	7.5	V	
Output voltage	V _O	40 (DC)	V	*1
Logic input voltage	V _{IN}	-0.5 to +7.5	V	
Output current	I _O	Self Limited	A	
Diag output voltage	V _{DIAG}	0 to V _{CC}	V	
Power Dissipation	P _D	2.8 to 5	W	*2
Storage temperature	T _{stg}	-40 to +150	°C	
Channel temperature	T _{ch}	150	°C	
Output avalanche capability	E _{AV}	100	mJ	Single pulse

*1. At the clamping operation, refer to the section of V_{OUT (clamp)} in electrical characteristics

*2. Changes by the pattern of mounted substrate

Electrical Characteristics

(V_B=14V, Ta=25°C unless otherwise specified)

Parameter	Symbol	Ratings			Unit	Conditions
		min	typ	max		
Operating power supply voltage 1	V _{B (opr)}	5.5		40	V	
Operating power supply voltage 2	V _{CC (opr)}	4.5		5.5	V	
Quiescent circuit current	I _q		4	6	mA	V _B =14V, V _{IN} =0V
Operating circuit current	I _d		8	12	mA	V _B =14V, V _{IN} =5V
Input voltage	Hi output	V _{IN}	3.5	5.5	V	V _B =14V, V _O =1A
	Lo output	V _{IN}	-0.5	1.5	V	V _B =14V
Input current	Hi output	I _{IN}		50	μA	V _B =14V, V _{IN} =5V
	Lo output	I _{IN}		-30	μA	V _B =14V, I _O 1A
Output ON resistance	R _{DS (ON)}			0.3	Ω	V _B =14V, I _O =1A, Ta=125°C
				0.2	Ω	V _B =14V, I _O =1A, Ta=25°C
Output clamp voltage	V _{OUT (clamp)}	45	50	55	V	V _B =14V, I _O =1A
Output leak current	I _{O H}			2.8	mA	V _B =14V, V _{CC} =5V, V _{IN} =0V, V _O =40V, Ta=25°C
				900	μA	V _B =14V, V _{CC} =5V, V _{IN} =0V, V _O =14V, Ta=25°C
Forward voltage of output stage diode	V _F			1.6	V	I _F =1A
Overvoltage protection starting voltage	V _{B (ovp)}	25		40	V	
Overvoltage protection hysteresis voltage	V _{B (ovp+hys)}		8		V	
Thermal shutdown operating temperature	T _{TSD}	151	165		°C	V _B =14V
Overcurrent protection operating current	I _S		6		A	V _B =14V, Ta=-40°C
			6		A	V _B =14V, Ta=25°C
			5		A	V _B =14V, Ta=125°C
Output transfer time	T _{ON}			12	μs	V _B =14V, R _L =14Ω, I _O =1A
	T _{OFF}			8	μs	
Output rise time	T _r			5	μs	
Output fall time	T _f			10	μs	
Output-diag voltage ratio	r _{a (DIAG)}	0.195	0.2	0.205		V _B =14V, V _O =1 to 14V, R _{diag} =500kΩ
Diag output clamping voltage	V _{DIAG (clamp)}			4.85	V	V _B =14V, V _{CC} =5V, V _O =40V

External Dimensions (unit: mm)

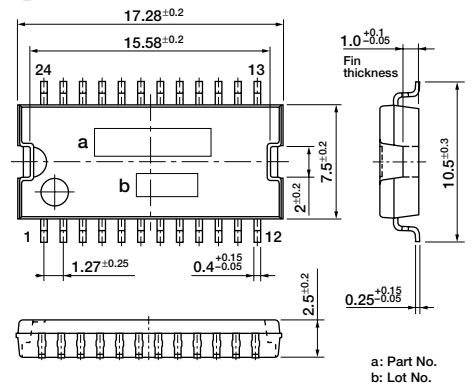

a: Part No.
b: Lot No.

Equivalent Circuit Diagram

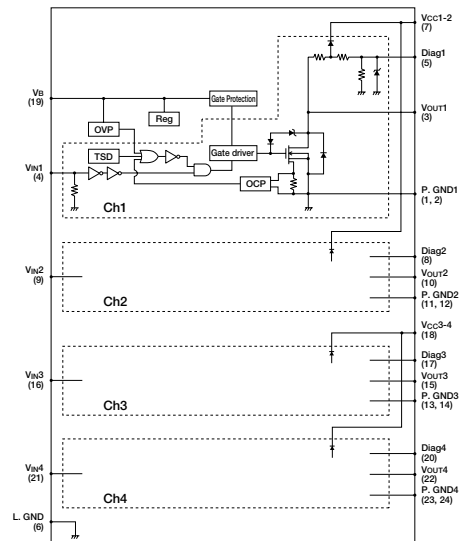

Circuit Example

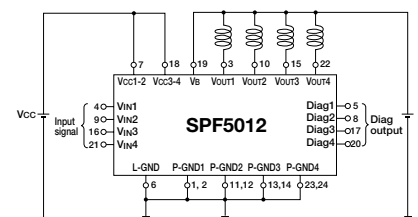

Truth table

V _{IN}	V _O
H	L
L	H

Short L-GND and P-GND in a pattern near the product.

Timing Chart

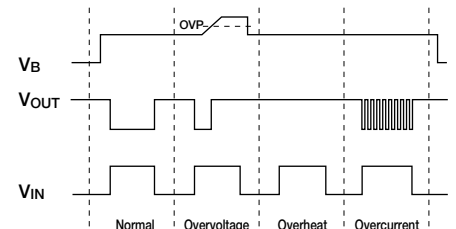

* Self-excited frequency is used in the overcurrent protection.



Stepper-motor Driver ICs SLA4708M

Features

- High output breakdown voltage of 50V
- Affluent output current of 1.5A
- Built-in overcurrent, overvoltage and thermal protection circuits
- Low standby current of 50 μ A

Absolute Maximum Ratings

(Ta=25°C)

Parameter	Symbol	Ratings	Unit	Conditions
Power supply voltage	V _S	35	V	
Breakdown voltage	V _O	50	V	
Input voltage	V _{IN}	-0.3 to +7	V	
Output current	I _{O,AVE}	1.5	A	
Diagnostic output sink current	I _{DIAG}	10	mA	
Diagnostic output withstand voltage	I _{DIAG, H}	7	V	
Operating temperature	Top	-40 to +85	°C	
Storage temperature	Tstg	-40 to +150	°C	
Power Dissipation	P _D	3.5 (Ta=25°C)	W	Without heatsink

Electrical Characteristics

(V_S=12V, Ta=25°C)

Parameter	Symbol	Ratings			Unit	Conditions
		min	typ	max		
Input voltage (I _A /I _B , I _B /I _B standby)	V _{IL}			0.8	V	
	V _{IH}	2.4			V	
Input current	I _{IL}			-0.8	mA	V _{IN} =0.4V
	I _{IH}			50	μ A	V _{IN} =2.4V
Output saturation voltage	V _{O,STA}			1.3	V	I _O =1A, Ta=25°C
	V _{O,STA}			1.5	V	I _O =1.5A, Ta=25°C
Output leak current	I _{O,LEAK}			100	μ A	V _O =16V
Overcurrent detection	I _{SD}	1.8			A	
Overvoltage detection	V _{SD}	27.5			V	
Saturation voltage of diagnostic output	V _{DIAG,L}			0.3	V	I _{DIAG} =5mA
Standby current	I _{STB}		50		μ A	V _S =12V

External Dimensions (unit: mm)

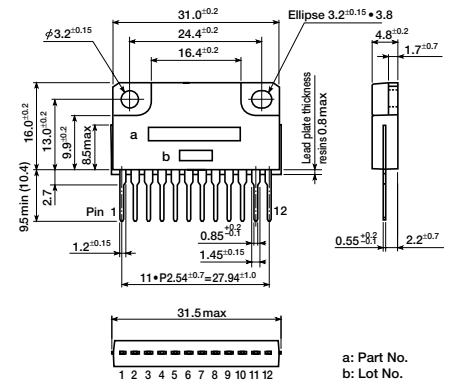

Standard Circuit Diagram

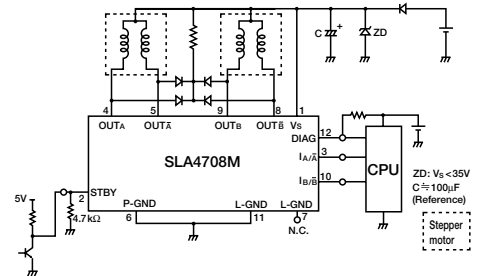

Electrical Characteristics

■ Power Supply Current Characteristics

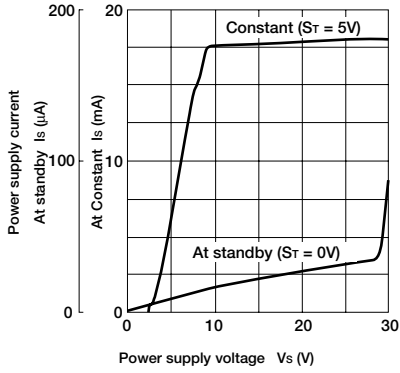

■ Overvoltage Protection Characteristics

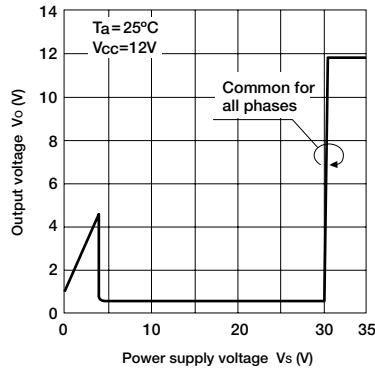

■ Saturation Voltage of Output Transistor Characteristics

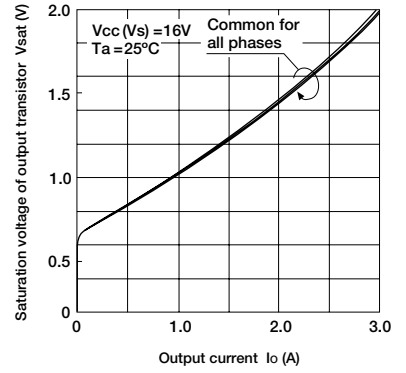

■ Thermal Protection Characteristics

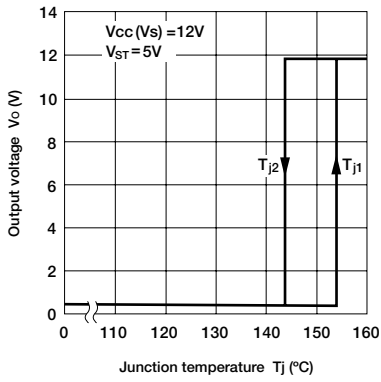

Electrical Characteristics

■ Vsat Temperature Characteristics (Io=0.5A)

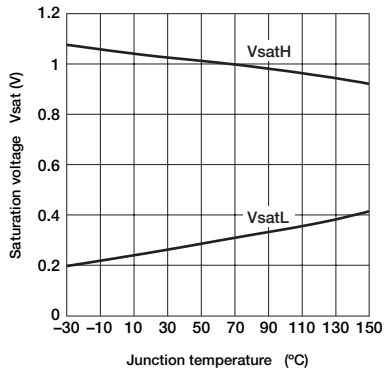

■ Diode Vf Characteristics (If=0.5A)

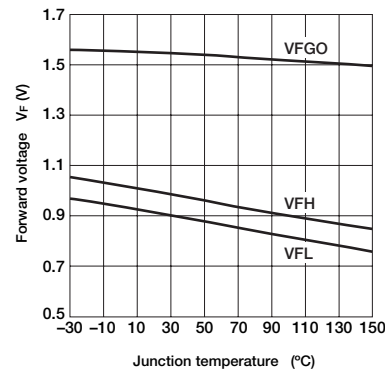

■ OSC Temperature Characteristics

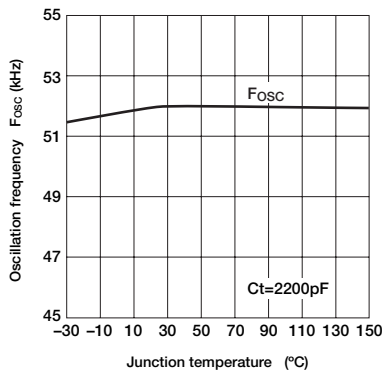

■ Ta-Pd Characteristics

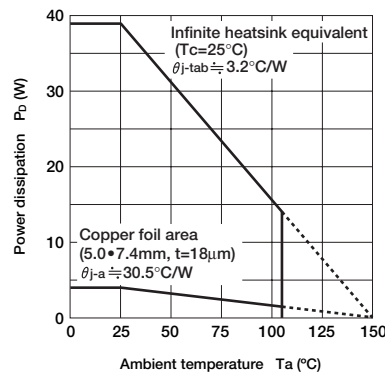

Full Bridge PWM Control DC Motor Driver ICs SI-5300

Features

- P-ch MOS for high side and N-ch MOS for low side in one package
- Enable to drive DC±5V
- Possible to drive a motor at the LS-TTL, C-MOS Logic level
- Guarantee $T_j=T_{ch}=150^{\circ}\text{C}$
- Built-in over current protection and thermal shut down circuits
- Built-in diagnosis function to monitor and signal the state of each protection circuits
- Built-in vertical current prevention circuits (Dead time is defined internally.)
- No insulator required for Sanken's original package (SPM package)

Absolute Maximum Ratings

($T_a=25^{\circ}\text{C}$)

Parameter	Symbol	Ratings	Unit	Conditions
Motor supply voltage	V_M	40	V	
Input terminal voltage	IN1	-0.3 to 7	V	
	IN2	-0.3 to 7	V	
	PWM	-0.3 to 7	V	
Output current	I_O	±5	A	
	$I_{O(p-p)}$	±17	A	$P_W \leq 1\text{ms}$, Duty $\leq 50\%$
PWM control frequency	f_{PWM}	20	kHz	Duty=20% to 80%
Forward • reverse rotation switch frequency*	f_{CW}	500	Hz	
Operating temperature	T_{OP}	-40 to +85	$^{\circ}\text{C}$	
Junction and channel temperature	T_j, T_{ch}	-40 to +150	$^{\circ}\text{C}$	
Storage temperature	T_{stg}	-40 to +150	$^{\circ}\text{C}$	
Thermal resistance	θ_{j-c}	3.7	$^{\circ}\text{C/W}$	
	θ_{j-a}	35	$^{\circ}\text{C/W}$	
Power dissipation	P_{D1}	3.6	W	Without heatsink
	P_{D2}	33.7	W	With infinite heatsink

Note: * The dead time for the length current prevention in positive and the reversing switch is set by internal control IC. The set point in internal IC at the dead time is 20μs (typical). Please take into account the dead time and consider the load conditions when you use the IC.

Electrical Characteristics

(Unless, otherwise specified, $T_j=T_{ch}=25^{\circ}\text{C}$, $V_M=14\text{V}$, $I_O=3\text{A}$)

Parameter	Symbol	Ratings			Unit	Conditions
		min	typ	max		
Motor supply voltage	V_{IN}	6		18	V	$V_M=24\text{V}$ (2 min.)
Output saturation voltage	V_i, V_M-V_O			0.8	V	$I_O=3\text{A}$
	V_i, V_O-PG			0.3	V	$I_O=3\text{A}$
Output leakage current	$I_{L, L}$		100		μA	$V_M=40\text{V}$
	$I_{L, H}$		100		μA	$V_M=40\text{V}$
Output transmission time	tpLH			10 *2	μs	$V_{PWM}: L \rightarrow H$ ($V_{th}=2.5\text{V typ}$)
	tpHL			15 *3	μs	$V_{PWM}: H \rightarrow L$ ($V_{th}=2.5\text{V typ}$)
	tpHL-tpLH			10	μs	
Forward voltage characteristic of diode between drain and source	$V_F \cdot L$		0.8		V	$I_O=3\text{A}$
	$V_F \cdot H$		1.0		V	$I_O=10\text{A}$
	$V_F \cdot L$		0.8		V	$I_O=3\text{A}$
	$V_F \cdot H$		1.0		V	$I_O=10\text{A}$
Static circuit current	IM1		22		mA	Stop mode
	IM2		22		mA	Forward and reverse mode
	IM3		16		mA	Brake mode
Input terminal voltage	$V_{IN, H}$	3.0			V	$V_{IN1}=V_{IN2}=V_{PWM}$
	$V_{IN, L}$			2.0	V	$V_{IN1}=V_{IN2}=V_{PWM}$
Input terminal current	$I_{IN, L}$	-100			μA	$V_{IN1}=V_{IN2}=V_{PWM}=0\text{V}$
	$I_{IN, H}$			200	μA	$V_{IN1}=V_{IN2}=V_{PWM}=5\text{V}$
OPC start current	I_{OCP}	16			A	*1
DIAG output pulse width	t_{DIAG}	20			ms	$C=1\mu\text{F}$ (typ)
DIAG terminal voltage	$V_{D \cdot L}$			0.3	V	$I_D = \text{SINK}=1\text{mA}$ *4

Note:

*1: The standard value of I_{OCP} is assumed to be a value by which the output of each Power MOS FET cuts off. When the protection circuit of OCP and TSD operates, Power MOS FETs keeps cutoff. When a signal (5V: H → 0V: L) is input to the terminal PWM, the cutoff operation will be released. Moreover, three minutes ($T_a=25^{\circ}\text{C}$, $f_{PWM}=10\text{kHz}$, $V_M=14\text{V}$) are assumed to be max at the overcurrent state continuance time in the V_M operation and the ground of output terminal (OUT1, OUT2). It is not the one to assure the operation including reliability in the state that the short-circuit continues for a long time.

*2: Output transmission time (tpLH)

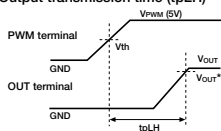

Output transmission time tpLH is time from V_{th} (2.5V typ) of the terminal of PWM to output ($V_{OUT} * 0.9$) of the output terminal.

*3: Output transmission time (tpHL)

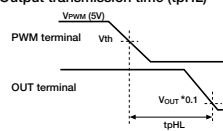

Output transmission time tpHL is time from V_{th} (2.5V typ) of the terminal of PWM to output ($V_{OUT} * 0.1$) of the output terminal.

*4: DIAG signal output terminal is an open collector output. Use a pull-up resistor when connecting it to a logic circuit.

External Dimensions (unit: mm)

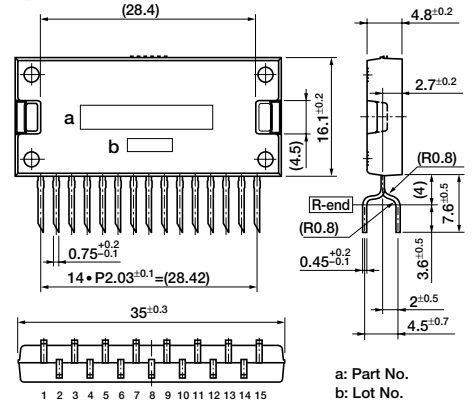

Equivalent Circuit

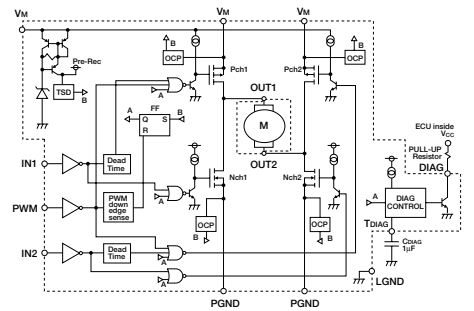

Standard Connection Diagram

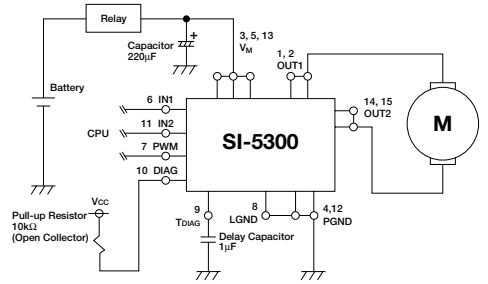

Timing Chart

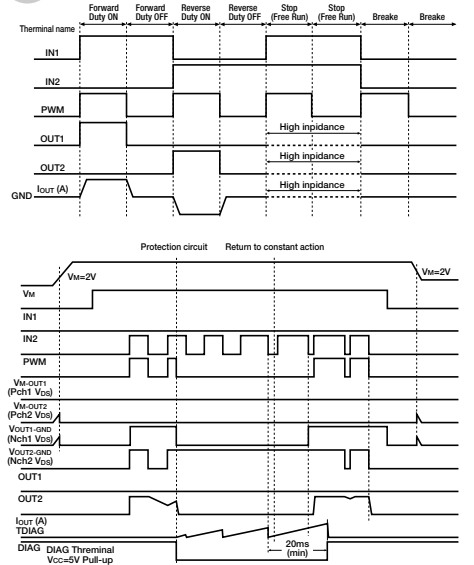

Electrical Characteristics

Output saturation voltage (Pch)

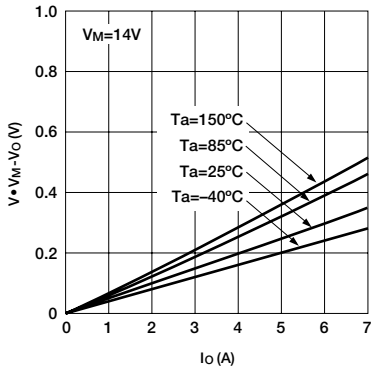

Output saturation voltage (Nch)

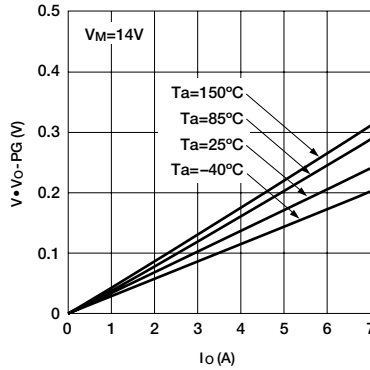

Forward voltage of Diode between drain and source

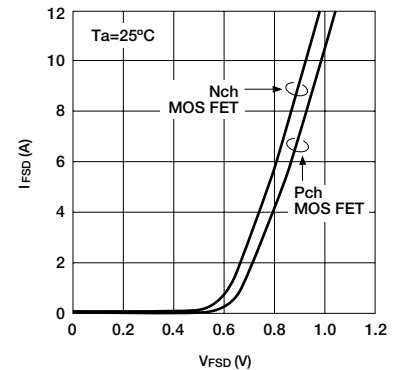

Quiescent circuit current

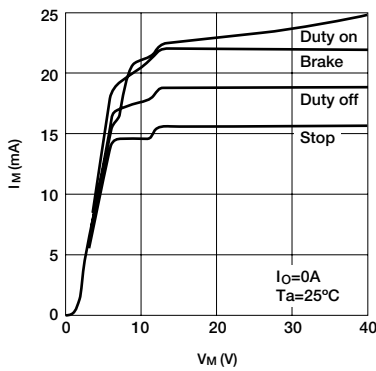

Voltage of input terminal (Threshold voltage)

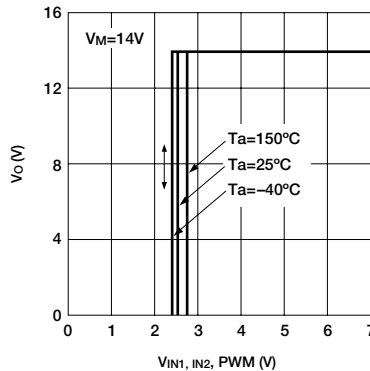

Current of input terminal (SINK current)

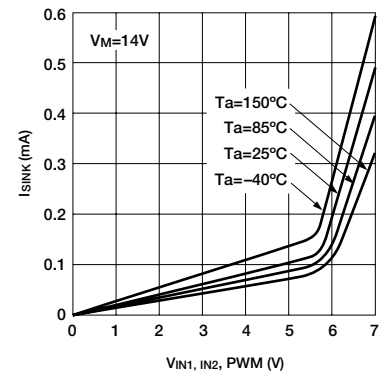

Current of input terminal (Source current)

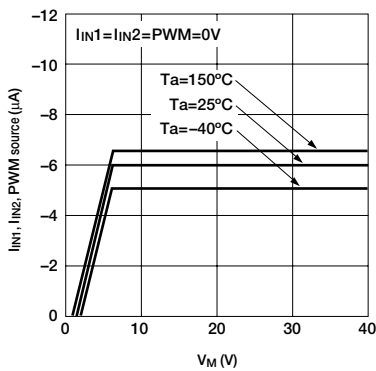

VTDIAG - VDIAG Characteristics

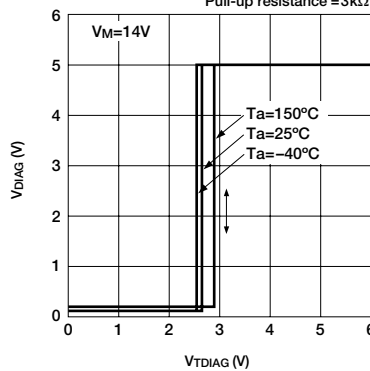

Thermal shut down protection

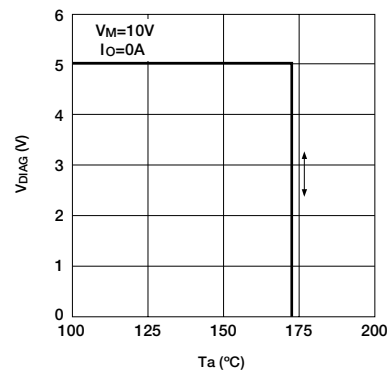

Pch MOS FET Safe Operating Area (SOA)

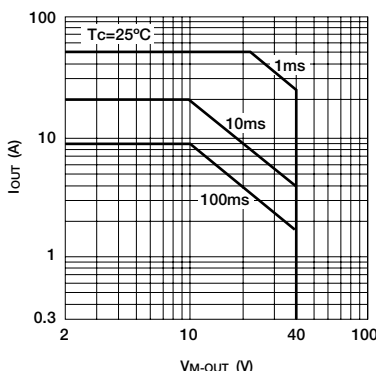

Nch MOS FET Safe Operating Area (SOA)

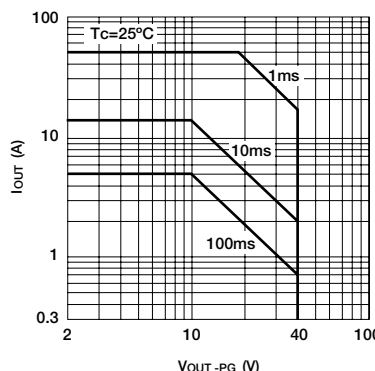

Pd-Ta Characteristics

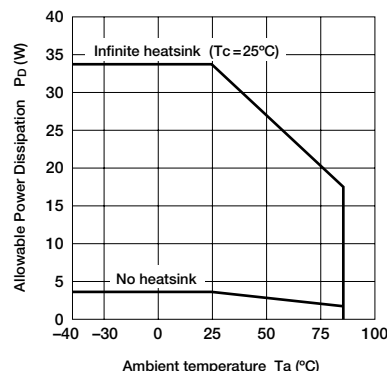

Full Bridge DC Motor Driver ICs – SPF7301 (under development)

Features

- A DMOS of low ON resistance (0.1Ω typ) is mounted on the high and low side power elements
- Two input signals control the forward/reverse/brake of a DC motor
- Current limit and overcurrent protection circuits
- Low voltage and thermal protection, excess input detecting output and input terminal open protection

Absolute Maximum Ratings

(Ta=25°C)

Parameter	Symbol	Ratings	Unit	Remarks
Main power supply voltage	V _B	-0.3 to 36	V	
Input terminal input voltage	V _{IN1} , V _{IN2}	-0.3 to 6	V	
EN terminal voltage	V _{EN}	-0.3 to 12	V	
Disable terminal input voltage	V _{DI}	-0.3 to 6	V	
Output current	I _o	±7	A	1kHz, Duty < 1%, Pulse < 10μS
	I _{oPeak}	±15	A	
DIAG output current	V _{DIAG}	-0.3 to 6	V	
DIAG inflow current	I _{DIAG}	-3	mA	DIAG terminal sink current
Power dissipation	P _{D1}	39	W	With an infinite heatsink mounted *1
	P _{D2}	4	W	
Junction temperature	T _J	-40 to 150	°C	
Operating temperature	T _{op}	-40 to 105	°C	
Storage temperature	T _{stg}	-40 to 150	°C	
Thermal resistance (junction to case)	θ _{J-C}	3.2	°C/W	
Thermal resistance (junction to ambient air)	θ _{J-A}	31	°C/W	

Note: *1: With glass epoxy + copper foil board (size 5.0*7.4cm; t: glass epoxy = 1.6mm/copper foil = 18μm)

Recommended Operation Range

Parameter	Symbol	Ratings	Unit	Remarks
Main power supply voltage	V _B	8 to 18	V	
DI terminal input voltage	V _{DI}	-0.3 to 5.3	V	
Input terminal input voltage	V _{INx}	-0.3 to 5.3	V	
Output current	I _o	±1	A	
DIAG terminal voltage	V _{DIAG}	-0.3 to 5.3	V	
Operating temperature	T _{op}	-40 to 105	°C	

Electrical Characteristics

(T_J = 30 to 125°C, V_B = 14V, EN = DI = 5V, C_{cp} = 33nF, R_{DIAG} = 20kΩ unless otherwise specified) *2

Parameter	Symbol	Ratings			Unit	Conditions
		min	typ	max		
Main power supply current	I _{BB1}		15		mA	For V _{EN} = 0V
	I _{BB2}			100	μA	
Low voltage protection operation voltage	V _{UVLOH}	5.0		7.0	V	
	V _{UVLOL}	4.5		6.5	V	
UVLO hysteresis voltage	ΔV _{UVLO}		0.5		V	
Output terminal leak current	I _{leakHS}	-100			μA	
	I _{leakLS}			100	μA	
Output DMOS RDS (ON)	R _{DS(ON)_1H}		100	200	mΩ	
	R _{DS(ON)_2H}		100	200	mΩ	
	R _{DS(ON)_1L}		100	200	mΩ	
	R _{DS(ON)_2L}		100	200	mΩ	
Forward voltage characteristics between output DMOS and DS	V _{F_H1}		1.5		V	I _{o1} = 1A
	V _{F_H2}		1.5		V	I _{o2} = 1A
	V _{F_L1}		1.5		V	I _{o1} = -1A
	V _{F_L2}		1.5		V	I _{o2} = -1A
Overcurrent limiting operation current	I _{ocp1_H1}	4.5	7	10	A	
	I _{ocp1_H2}	4.5	7	10	A	
	I _{ocp1_L1}	4.5	7	10	A	
	I _{ocp1_L2}	4.5	7	10	A	
OPC start current	I _{ocp2_H1}		15		A	
	I _{ocp2_H2}		15		A	
	I _{ocp2_L1}		15		A	
	I _{ocp2_L2}		15		A	
Input terminal voltage V _{IN1} , V _{IN2}	V _{INxH}	2			V	
	V _{INxL}			0.8	V	
Input terminal current V _{IN1} , V _{IN2}	I _{INxH}	-100			μA	V _{DI} = 5V
	I _{INxL}	-100			μA	
DI terminal voltage	V _{DIxH}	2			V	
	V _{DIxL}			0.8	V	
DI terminal current	I _{DIxH}	-100			μA	V _{DI} = 5V
	I _{DIxL}	-100			μA	
EN terminal input voltage	V _{ENth}	0.8		4	V	
EN terminal input current	I _{ENH}			100	μA	V _{EN} = 5V
	I _{ENL}	-10		10	μA	
DIAG terminal output voltage	V _{DIAG}			0.8	V	I _{DIAG} = 0.5mA
DIAG terminal output current	I _{DIAG}	1.5			mA	For V _{DIAG} = 1.6V
DIAG terminal leak current	I _{DIAGL}	-10		15	μA	
Input delay time	T _{dON}			20	μS	Time from V _{INxH} to V _{outx} * 0.2
	T _{dOFF}			15	μS	Time from V _{INxL} to V _{outx} * 0.8
	T _r			6	μS	Time of V _{outx} from 20% to 80%
	T _f			6	μS	Time of V _{outx} from 80% to 20%
	T _{ddis}			4	μS	Time from D _{lthH} to V _{outx} * 0.2
Overvoltage protection operation voltage	V _{ovp}	35	40	45	V	
OVP hysteresis width	ΔV _{ovp}		5		V	
Thermal protection starting temperature	T _{tsd_ON}	151	165		°C	*3
Thermal protection hysteresis width	ΔT _{tsd}		15		°C	*3

Note:

*2: For the electrical characteristics for T_J = -40 to 150°C, the design warranty applies to the above specification values.

*3: Thermal protection starting temperature is 165°C (typ) by design. The above parameters are the design specifications.

External Dimensions (unit: mm)

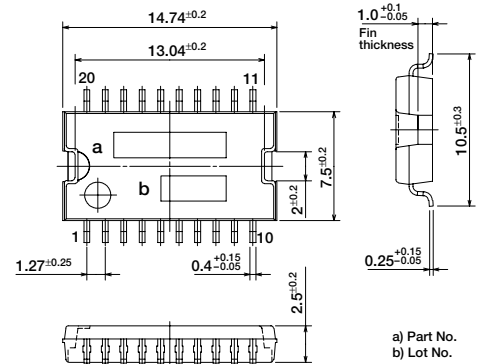

a) Part No.
b) Lot No.

Standard Circuit Diagram

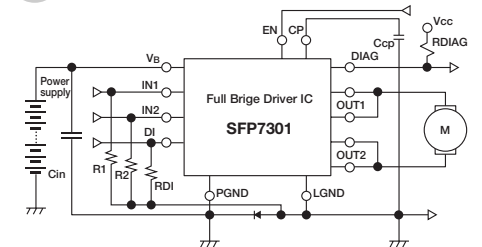

* Recommended connection parts

Pressure rise capacitor for charge pump circuits (CP to GND) Cp 33nF

DIAG terminal pull-up resistance RDIAG: 20kΩ

Input terminal pull-down resistance R1, R2, RDI: 10kΩ



High Voltage Full Bridge Drive ICs SLA2402M

Features

- One Package Full Bridge Driver Consisted of High Voltage IC and Power MOS FETs (4 pieces)
- High Voltage Driver which accepts direct connection to the input signal line
- External components such as high voltage diodes and capacitors are not required

Absolute Maximum Ratings

Parameter	Symbol	Ratings	Unit	Conditions
Power source voltage *	V_M	500	V	
Input voltage	V_{IN}	15	V	
Output voltage	V_O	500	V	
Output current	I_O	15	A	$P_W \leq 250 \mu s$
Power dissipation	P_D	5 ($T_a=25^\circ C$)	W	Without heatsink
Storage temperature	T_{stg}	-40 to +125	$^\circ C$	
Operation temperature	T_{opr}	-40 to +105	$^\circ C$	

* Power GND (D terminal) to -HV (-HV terminal) voltage.

Electrical Characteristics

Parameter	Symbol	Ratings			Unit	Conditions
		min	typ	max		
Power MOS FET output breakdown voltage	BV_{OUT}	500			V	$I_O=100 \mu A$
Power MOS FET output leakage voltage	$I_{OUT(off)}$			100	μA	$V_O=500V$
High-side Power MOS FET output on-state voltage	$V_{OUT(on)1}$	0.28	0.4	0.52	V	$I_O=0.4A, V_{IN}=10V$
	$V_{OUT(on)2}$	1.4	2.0	2.6	V	$I_O=2A, V_{IN}=10V$
Low-side Power MOS FET output on-state voltage	$V_{OUT(on)1}$	0.28	0.4	0.52	V	$I_O=0.4A, V_{GL}=10V$
	$V_{OUT(on)2}$	1.4	2.0	2.6	V	$I_O=2A, V_{GL}=10V$
Quiescent circuit current	I_{CC1}			3.0	mA	$V_{CC}=4.5$ to $15V$
	I_{CC2}			4.0	mA	$V_{CC}=10V, V_M=400V$
Operating circuit current	I_{CC3}			4.0	mA	$V_{CC}=10V, V_M=400V$
Input voltage (High level)	V_{IH}	$0.8V_{CC}$			V	$V_{CC}=4.5$ to $15V$
Input voltage (Low level)	V_{IL}			$0.2V_{CC}$	V	$V_{CC}=4.5$ to $15V$
Delay time *	$t_d(on)$		1.4		μs	$V_{CC}=10A, V_{IN}=10V, V_M=85A, I_O=0.41A$
	$t_d(off)$			3.3	μs	
	Δt			2.5	μs	
Operating voltage	V_{CC}			15	V	-40 to +105 $^\circ C$

* About delay time

Signal input waveform vs output waveform

① Highside switch turn-on, turn-off

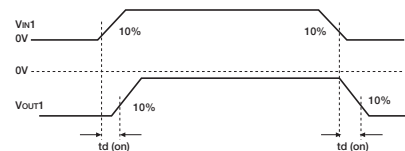

② Lowside switch turn-on, turn-off

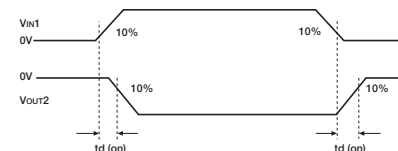

* $\Delta t: \Delta t = t_d(on) - t_d(off)$

Measurement Circuit

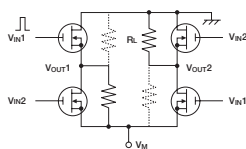

Conditions

$V_{CC}=10V, V_{IN}=10V$ (pulse)
 $V_M=85V$
 $I_O=0.41A$ ($R_L=207\Omega$)

* When pulse signal is inputted to V_{IN1} , R_L on solid line is ON and dotted line R_L is off.
 On the contrary, when pulse signal is inputted to V_{IN2} , R_L on dotted line is ON and dotted line R_L is off.

External Dimensions (unit: mm)

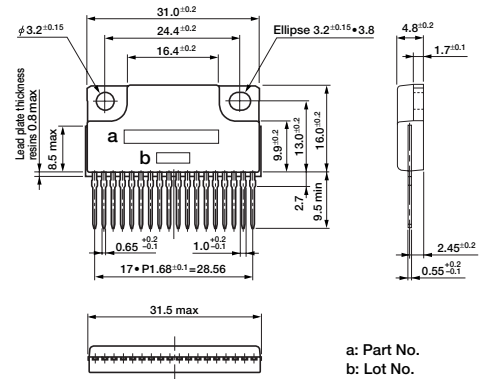

Block Diagram

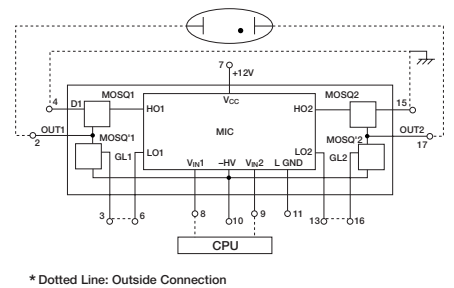

* Dotted Line: Outside Connection

Timing Chart

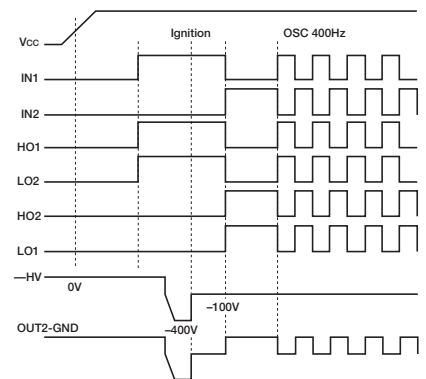

Electrical Characteristics

■ Quiescent circuit current

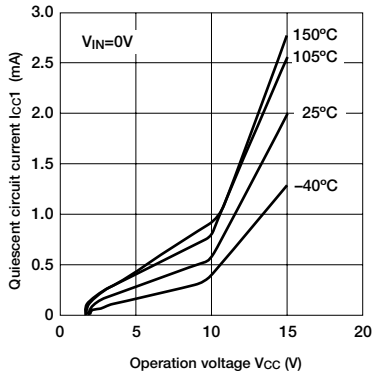

■ Quiescent circuit current supplied high voltage

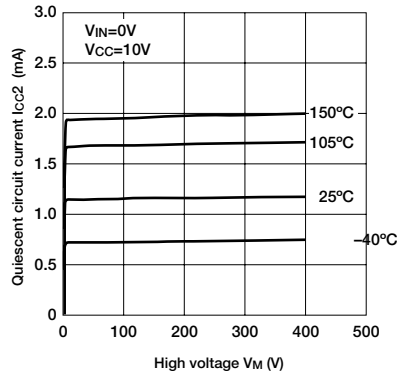

■ Operating circuit current

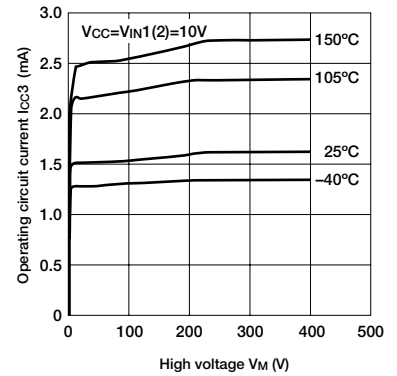

■ Quiescent circuit current supplied high voltage

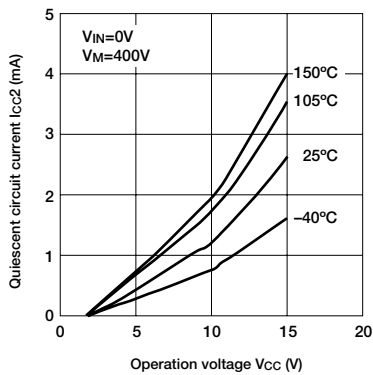

■ Quiescent circuit current

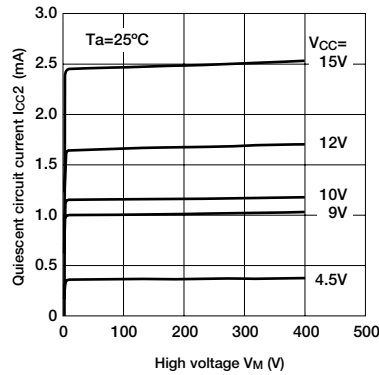

■ Operating circuit current

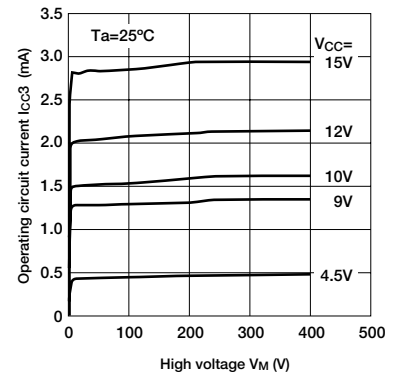

■ Output on-state voltage

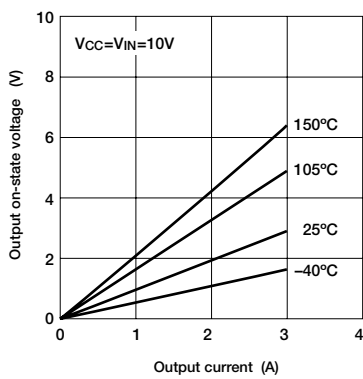

■ Gate drive voltage

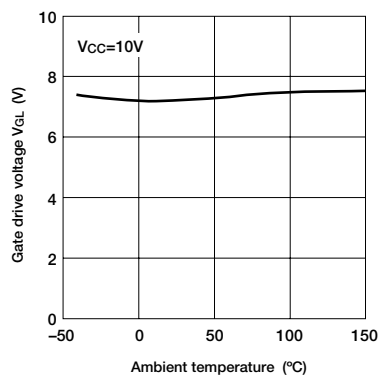

■ Gate drive voltage

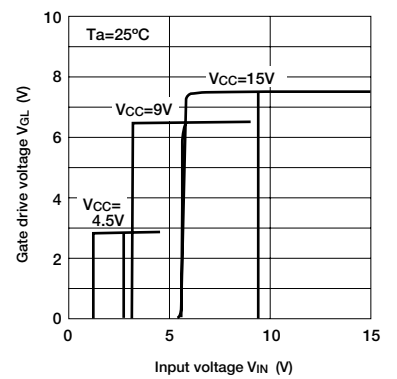

■ Output on-state voltage

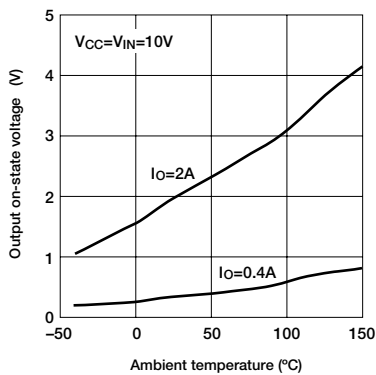

■ Input threshold voltage

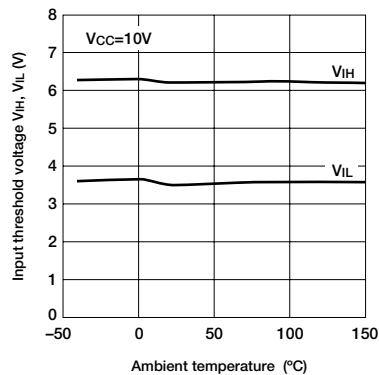

Electrical Characteristics

High side switch turn-on, off

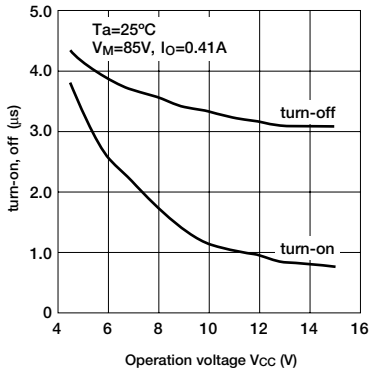

High side switch turn-on, off

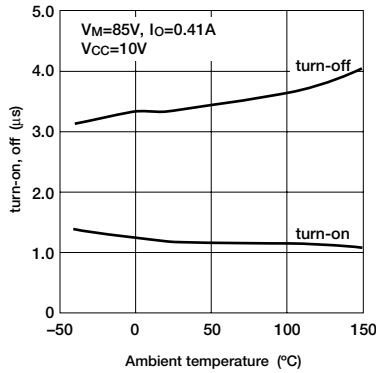

Low side switch turn-on, off

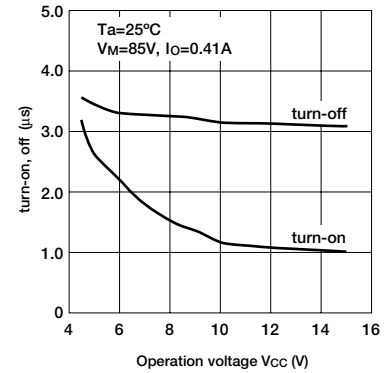

Low side switch turn-on, off

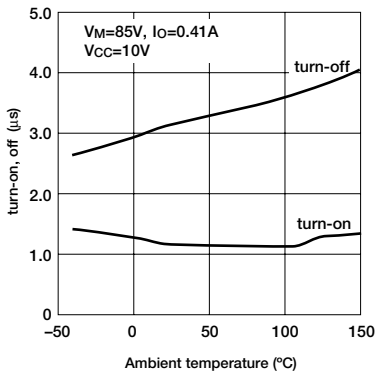

Transient thermal resistance characteristics

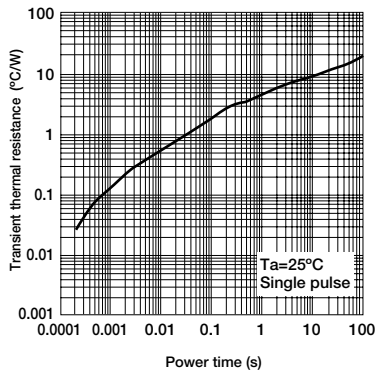

Safe operating area (Power MOS FET)

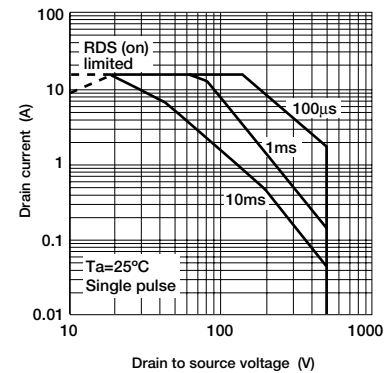

Power derating curve

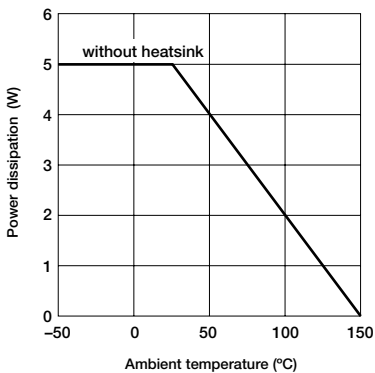



High Voltage Full Bridge Drive ICs SLA2403M

Features

- One Package Full Bridge Driver Consisted of High Voltage IC and Power MOS FETs (4 pieces)
- High Voltage Driver which accepts direct connection to the input signal line
- External components such as high voltage diodes and capacitors are not required

Absolute Maximum Ratings

Parameter	Symbol	Ratings	Unit	Conditions
Power source voltage *	V_M	500	V	
Input voltage	V_{IN}	15	V	
Output voltage	V_O	500	V	
Output current	I_O	7	A	$T_C=25^\circ\text{C}$
	I_O (peak)	15	A	$P_W \leq 250\mu\text{s}$
Power dissipation	P_D	5 ($T_a=25^\circ\text{C}$)	W	Without heatsink
		40 ($T_C=25^\circ\text{C}$)	W	With infinite heatsink
Storage temperature	T_{stg}	-40 to +125	$^\circ\text{C}$	
Operation temperature	T_{opr}	-40 to +125	$^\circ\text{C}$	
Junction temperature	T_J	150	$^\circ\text{C}$	

* Power GND (D terminal) to -HV (-HV terminal) voltage.

Electrical Characteristics

Parameter	Symbol	Ratings			Unit	Conditions
		min	typ	max		
Power MOS FET output breakdown voltage	BV_{OUT}	500			V	$I_O=100\mu\text{A}$
Power MOS FET output leakage voltage	$I_{OUT(off)}$			100	μA	$V_O=500\text{V}$
High-side Power MOS FET output on-state voltage	$V_{OUT(on)}$	0.18	0.26	0.34	V	$I_O=0.4\text{A}$, $V_{IN}=10\text{V}$
Lowside Power MOS FET output on-state voltage	$V_{OUT(on)}$	0.18	0.26	0.34	V	$I_O=0.4\text{A}$, $V_{GL}=10\text{V}$
Quiescent circuit current	I_{CC1}			3.0	mA	$V_{CC}=6$ to 15V
	I_{CC2}			4.0	mA	$V_{CC}=10\text{V}$, $V_M=400\text{V}$
Operating circuit current	I_{CC3}			4.0	mA	$V_{CC}=10\text{V}$, $V_M=400\text{V}$
Input voltage (High level)	V_{IH}	$0.8V_{CC}$			V	$V_{CC}=6$ to 15V
Input voltage (Low level)	V_{IL}			$0.2V_{CC}$	V	$V_{CC}=6$ to 15V
Delay time *	$t_d(on)$		2.0		μs	$V_{CC}=10\text{A}$, $V_{IN}=10\text{V}$, $V_M=85\text{V}$, $I_O=0.41\text{A}$
	$t_d(off)$		3.0		μs	
Operating voltage	V_{CC}	6		15	V	-40 to +125 $^\circ\text{C}$

* About delay time

Signal input waveform vs output waveform

① Highside switch turn-on, turn-off

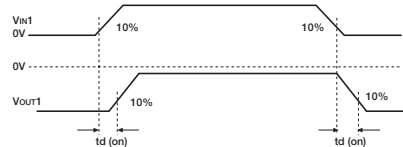

② Lowside switch turn-on, turn-off

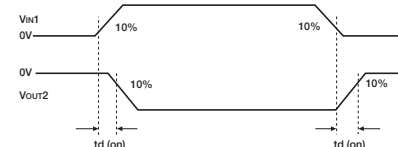

* $\Delta t: \Delta t = t_d(on) - t_d(off)$

Measurement Circuit

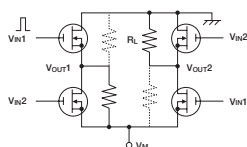

Conditions

$V_{CC}=10\text{V}$, $V_{IN}=10\text{V}$ (pulse)
 $V_M=85\text{V}$
 $I_O=0.41\text{A}$ ($R_L=207\Omega$)

* When pulse signal is inputted to V_{IN1} , R_L on solid line is ON and dotted line R_L is off.
 On the contrary, when pulse signal is inputted to V_{IN2} , R_L on dotted line is ON and solid line R_L is off.

External Dimensions (unit: mm)

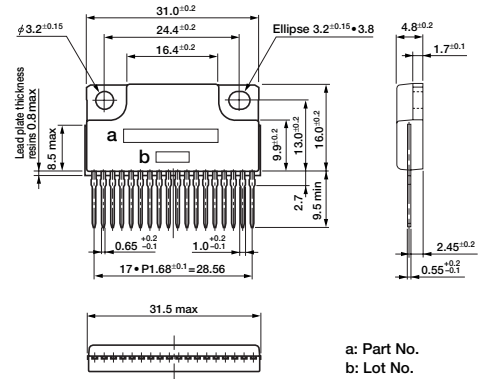

Block Diagram

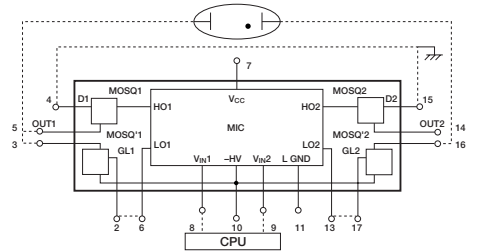

* Dotted Line: Outside Connection

Timing Chart

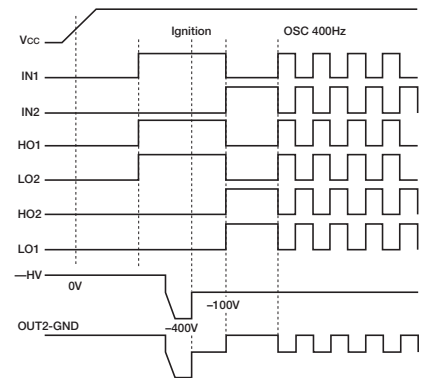

Electrical Characteristics

■ Quiescent circuit current

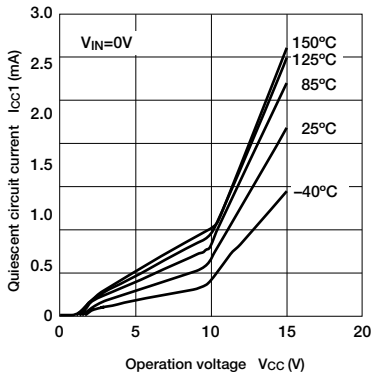

■ Quiescent circuit current supplied high voltage

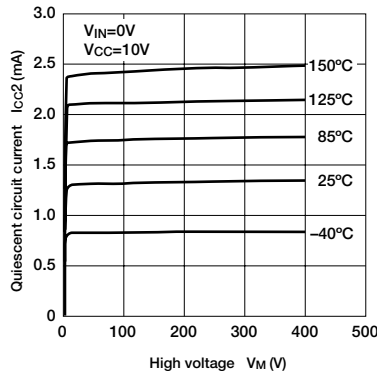

■ Operating circuit current

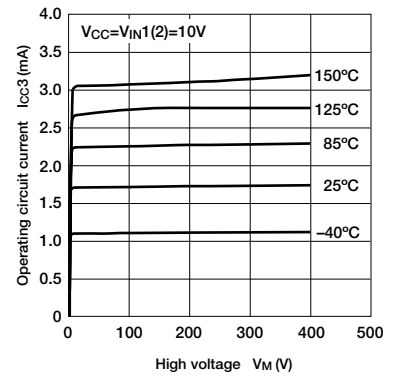

■ Quiescent circuit current supplied high voltage

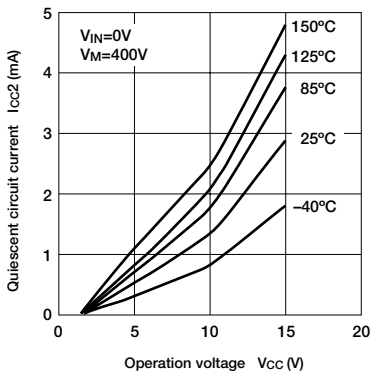

■ Quiescent circuit current supplied high voltage

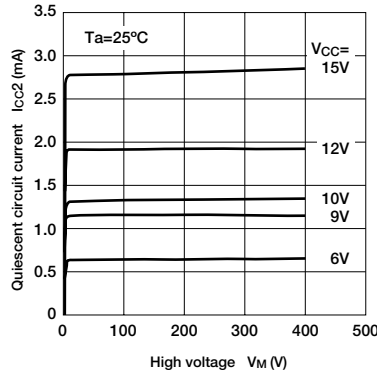

■ Operating circuit current

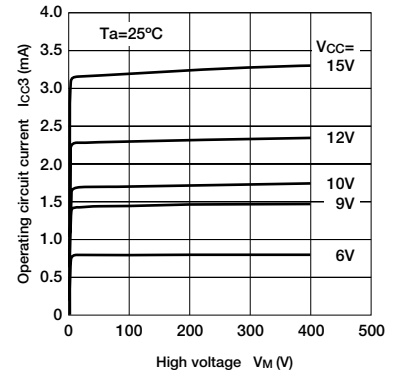

■ Output on-state voltage

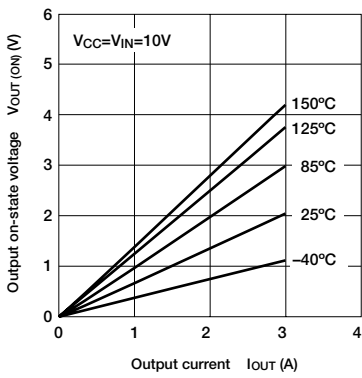

■ Input threshold voltage

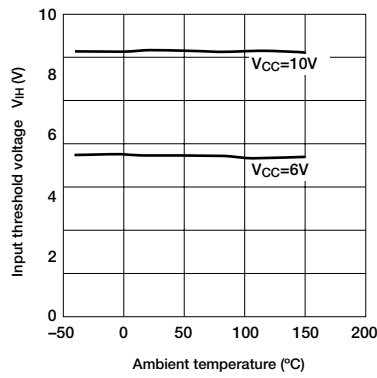

■ Gate drive voltage

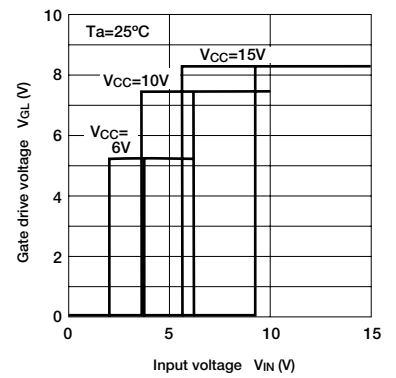

■ Output on-state voltage

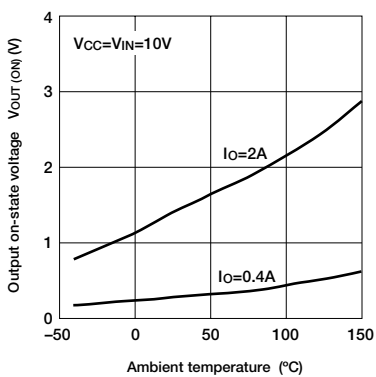

■ Input threshold voltage

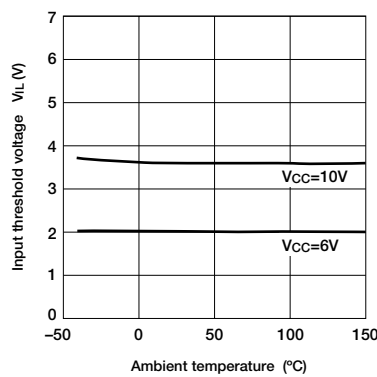

■ Gate drive voltage

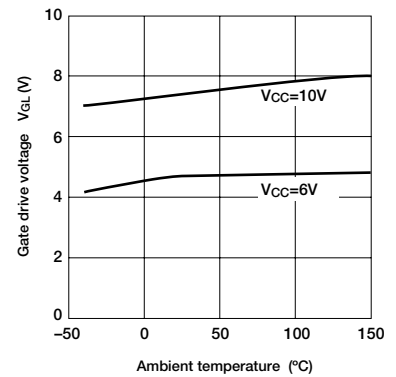

Electrical Characteristics

High side switch turn-on, off

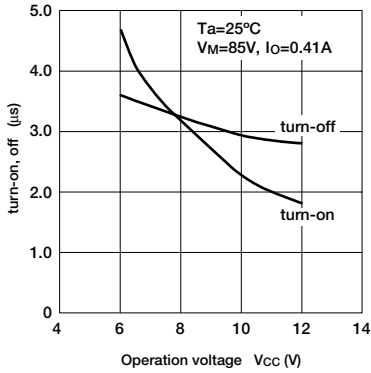

High side switch turn-on, off

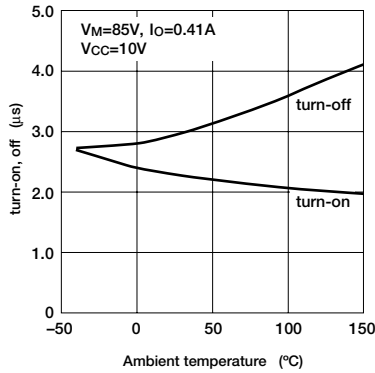

Low side switch turn-on, off

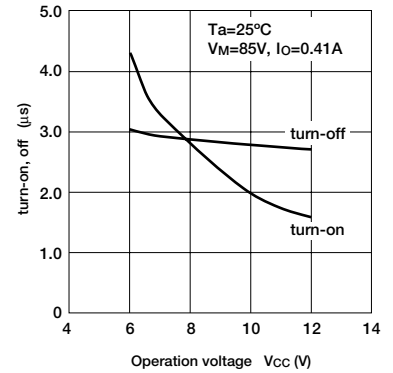

Low side switch turn-on, off

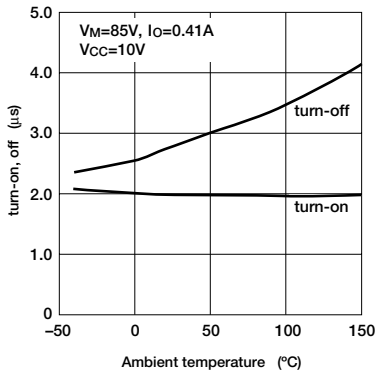

Transient thermal resistance characteristics

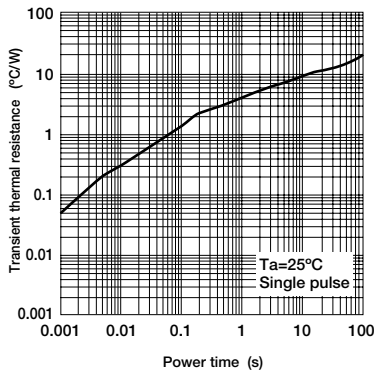

Safe operating area (Power MOS FET)

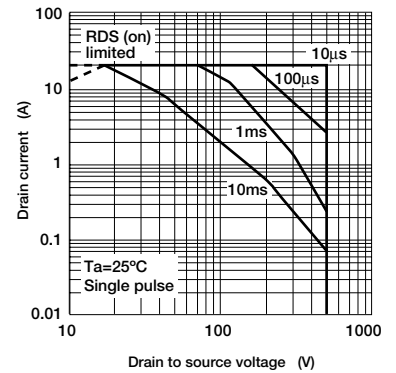

Power derating curve

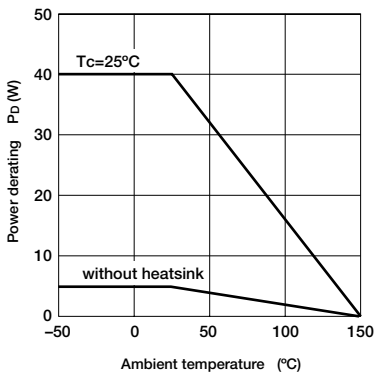



High Voltage Full Bridge Drive ICs SMA2409M

Features

- One Package Full Bridge Driver Consisted of High Voltage IC and Power IGBT (4 pieces)
- High Voltage Driver which accepts direct connection to the input signal line

Absolute Maximum Ratings

(Ta=25°C)

Parameter	Symbol	Ratings	Unit	Conditions
Power supply voltage	V _M	500	V	Power GNG to HV
Input voltage	V _{IN}	15	V	
Operation voltage	V _{CC}	15	V	
Output voltage	V _O	500	V	
Output current (DC)	I _{O(DC)}	7	A	
Output current (pulses)	I _{O(pulse)}	15	A	Single pulse (PW=50μs max.)
Power dissipation	P _D	4	W	T _C =25°C
		20		
Thermal resistance	θ _{J-a}	31.2	°C/W	T _C =25°C
		6.2		
Operating temperature	T _{opr}	-40 to +105	°C	
Storage temperature	T _{stg}	-40 to +150	°C	
Junction temperature	T _J	150	°C	
IGBT single pulse avalanche resistance	E _{AS}	5	mJ	V _{DD} =30V, L=1mH, Unclamped, I _C =3.2A
ESD protection	E _{SD}	±2	kV	Human body model (C=100pF, R=1.5kΩ)

External Dimensions (unit: mm)

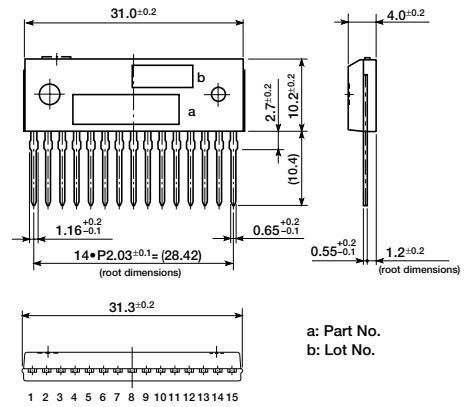

Electrical Characteristics

(Ta=25°C)

Parameter	Symbol	Ratings			Unit	Conditions	
		min	typ	max			
IGBT output breakdown voltage	BV _{OUT}	570			V	I _O =100μA, T _J =25°C	
IGBT output leak current	I _{OUT(off)}		1.0	1.2	μA	V _O =500V	
IGBT output ON voltage	V _{OUT(on)}		1.3	1.8	V	I _O =0.4A, V _{IN} (or V _{GL})=10V	
					V	I _O =2.0A, V _{IN} (or V _{GL})=10V	
Quiescent circuit current	I _{CC1}			3.0	mA	V _{CC} =10V, V _M =V _{IN} =0V	
	I _{CC2}			4.0	mA	V _{CC} =10V, V _M =400V, V _{IN} =0V	
Operating circuit current	I _{CC3}			4.0	mA	V _{CC} =10V, V _M =400V, V _{IN1} (or V _{IN2})=10V	
Input threshold voltage	V _{IH}	0.8•V _{CC}			V	V _{CC} =9 to 15V	
	V _{IL}			0.2•V _{CC}	V		
Low-side IGBT gate drive voltage	V _{GL}	0.8•V _{CC}		16	V	V _{CC} =9 to 15V	
	t _{d(on)}	0.6	0.7	0.8	μs		V _M =85V, I _O =0.41A
Delay time*	High side	t _{d(off)}	1.8	2.2	2.6	μs	V _{CC} =10V
		t _{d(on)}	0.8	0.9	1.0	μs	V _{IN} =10V (Out Stage=ON)
	Low side	t _{d(on)}	0.8	0.9	1.0	μs	V _{IN} =0V (Out Stage=OFF)
		t _{d(off)}	1.3	1.6	1.9	μs	
	Δt _d			2.5	μs	Δt _d =H/S t _{d(off)} - L/S t _{d(on)} or L/S t _{d(off)} - H/S t _{d(on)}	
Operating voltage	V _{CC}	9		15	V	T _a =-40 to +105°C	

Recommended Operation Range

Parameter	Symbol	Ratings			Unit	Conditions
		min	typ	max		
Dead time	t _d	5.0			μs	T _a =-40 to +105°C

* About delay time

Signal input waveform vs output waveform

① Highside switch turn-on, turn-off

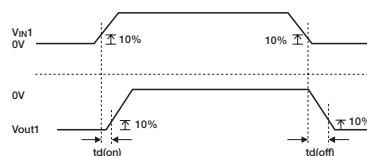

② Lowside switch turn-on, turn-off

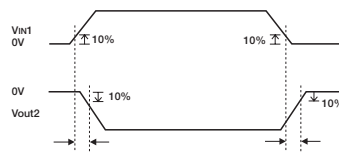

Measurement Circuit

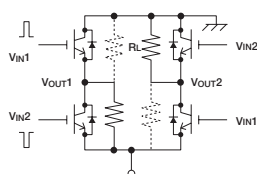

Conditions

V_{CC}=10V, V_{IN}=10V (pulse)

V_M=85V

I_O=0.41A (R_L=206Ω)

* When pulse signal is inputted to V_{IN1}, R_L on solid line is ON and dotted line R_L is off.

On the contrary, when pulse signal is inputted to V_{IN2}, R_L on dotted line is ON and solid line R_L is off.

Block Diagram

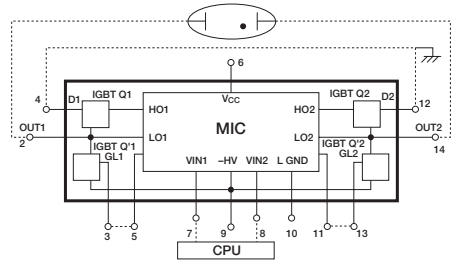

* Dotted Line: Outside Connection

Timing Chart

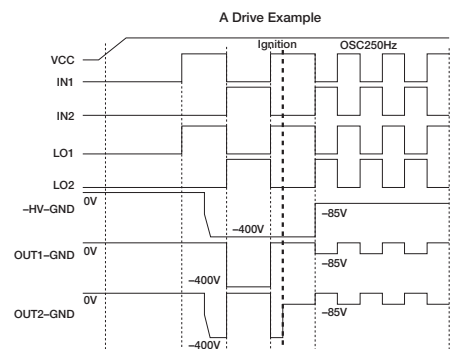

Electrical Characteristics

■ Quiescent circuit current

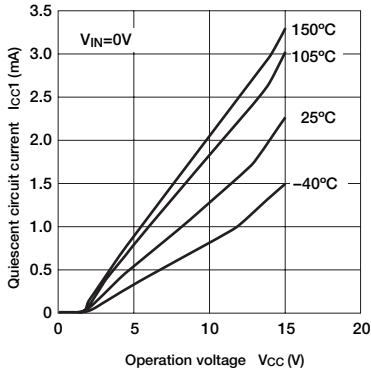

■ Quiescent circuit current supplied high voltage

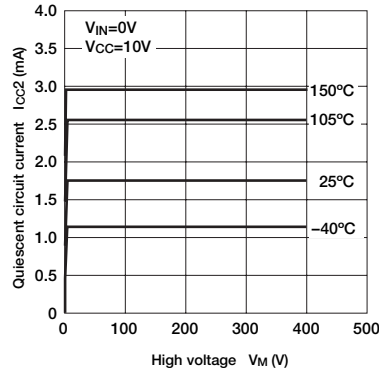

■ Operating circuit current

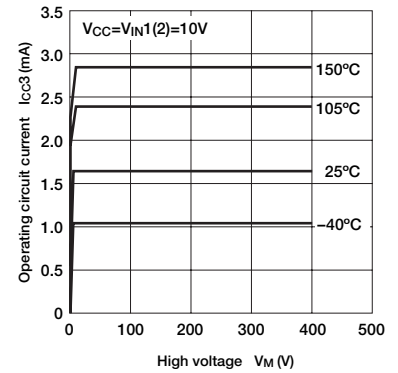

■ Quiescent circuit current supplied high voltage

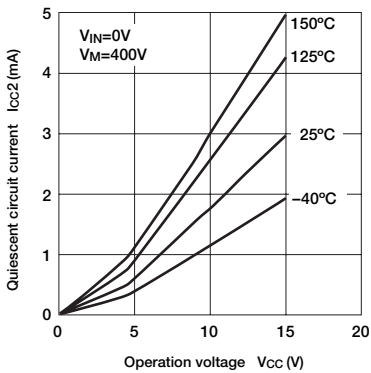

■ Quiescent circuit current supplied high voltage

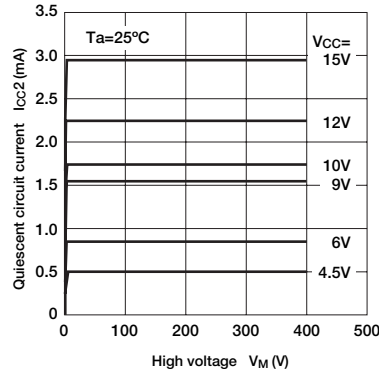

■ Operating circuit current

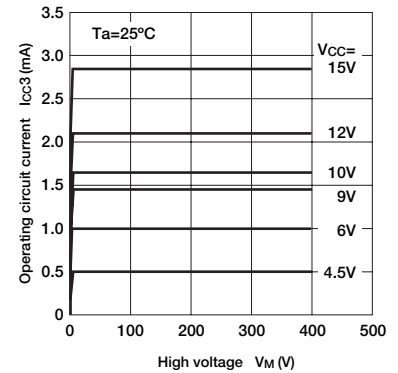

■ Output on-state voltage

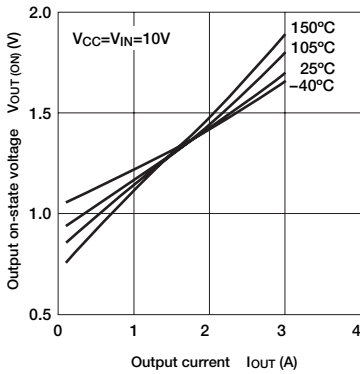

■ Input threshold voltage

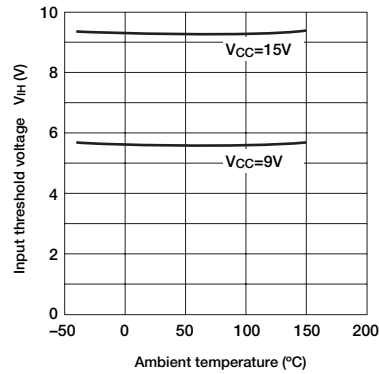

■ Gate drive voltage

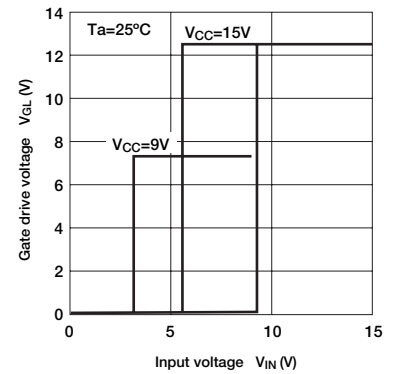

■ Output on-state voltage

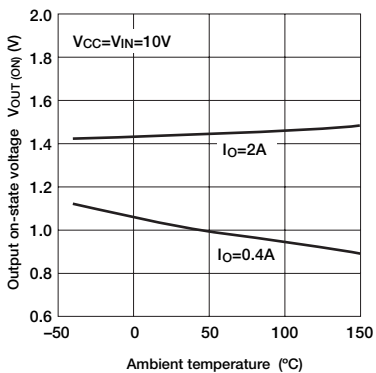

■ Input threshold voltage

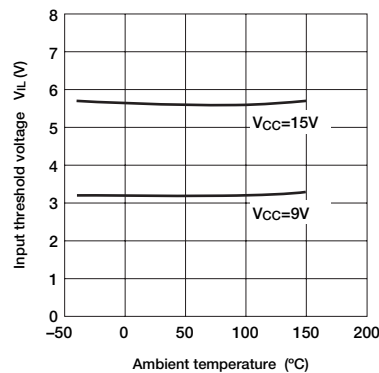

■ Gate drive voltage

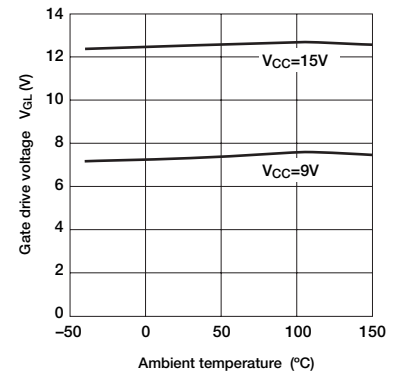

Electrical Characteristics

High side switch turn-on, off

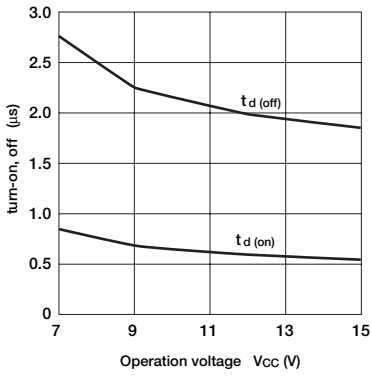

High side switch turn-on, off

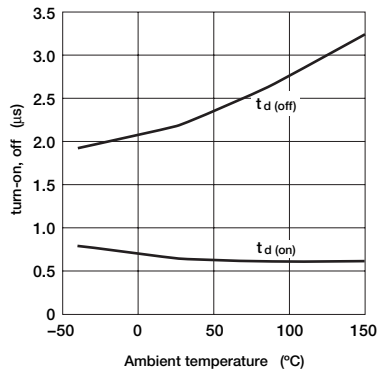

Low side switch turn-on, off

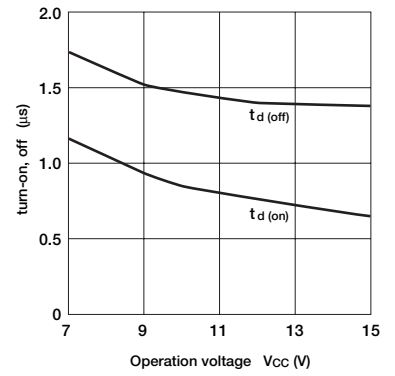

Low side switch turn-on, off

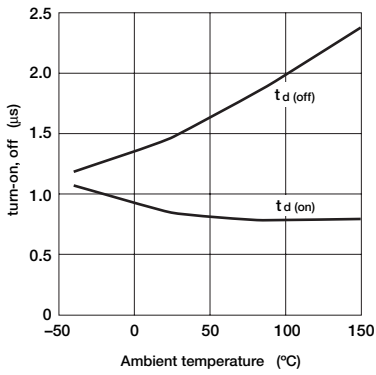

Transient thermal resistance characteristics

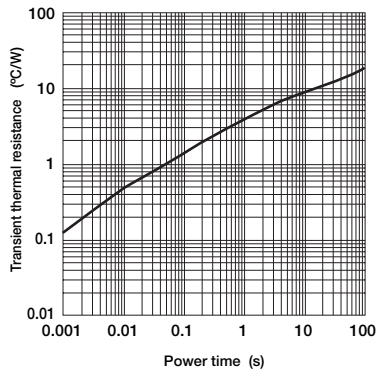

IGBT ASO characteristics

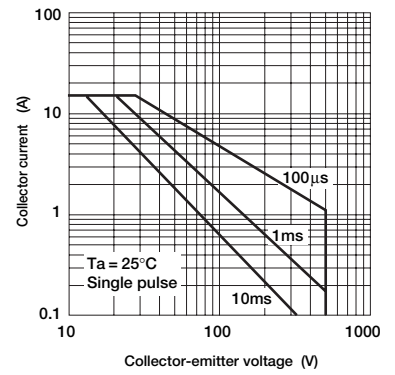

Power derating curve

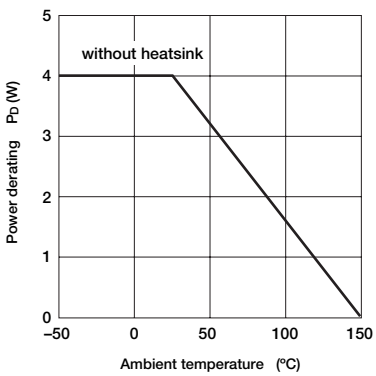



Custom ICs

- Various processing technologies of BIP, BiCMOS, CMOS and BCD can be used for the semiconductor chips.
- Meets detailed user needs, especially power ICs. A wide range of general-purpose ICs is also available.
- Employs a monolithic chip with flip-chip construction for increased reliability making it ideal for car electronic devices.
- Also available in hybrid ICs with transfer mold construction, multi-chip IC configuration and power monolithic IC configuration.

Features

- All semiconductor chips used are manufactured by Sanken.
- Main product lineup consists of power ICs produced out of many years' experience of Sanken.
- Uses monolithic chips with flip-chip construction.
- Mainly available in miniature transfer-mold packages.

Examples of Custom Hybrid IC Products

- Regulators for alternators
- Igniters
- Power supply for microcomputer system
- Power steering control IC
- Motor and actuator driver
- Others

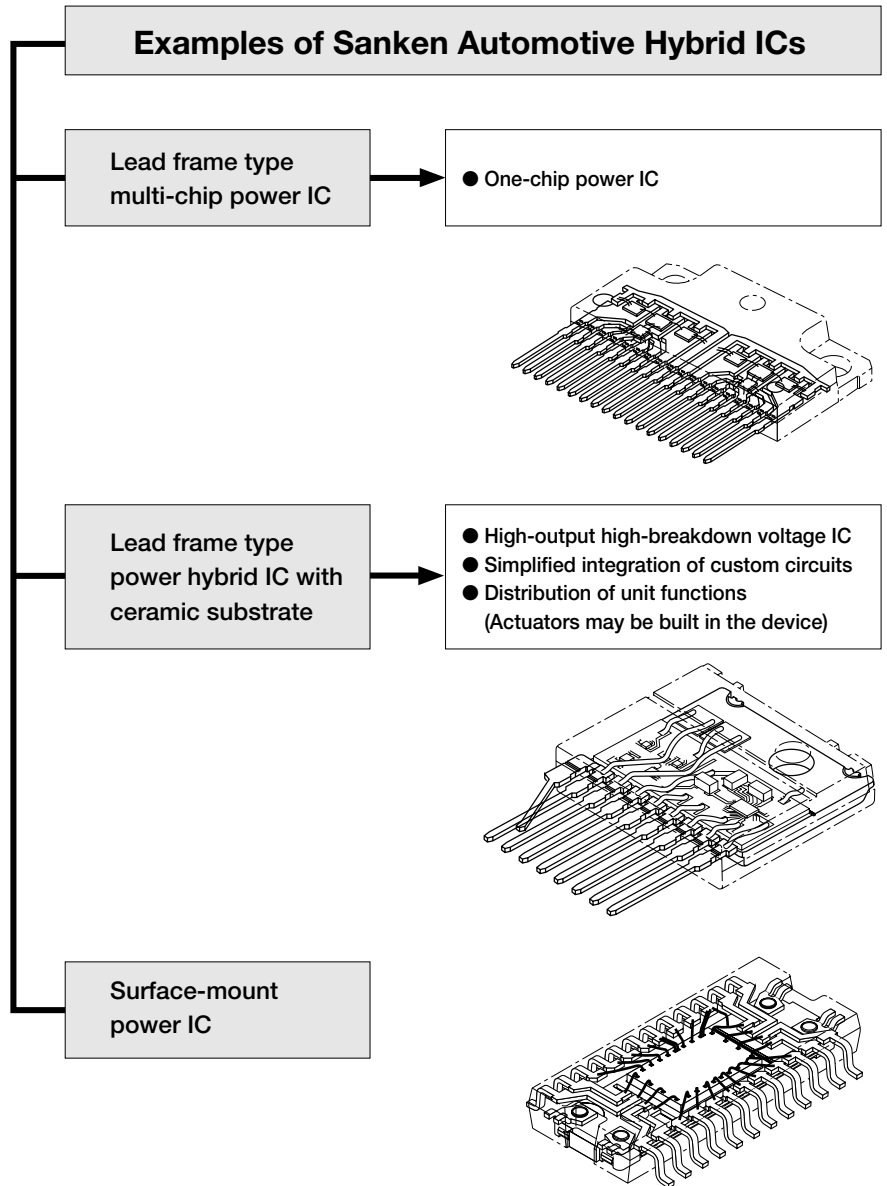

External Dimensions (unit: mm)

MT-100

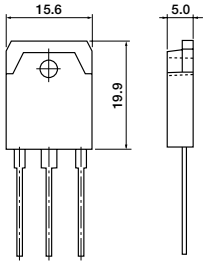

FM205

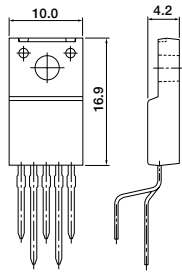

STA 8pin

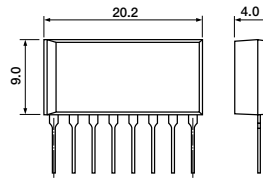

STA 10pin

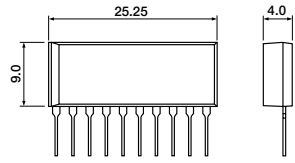

SMA12pin

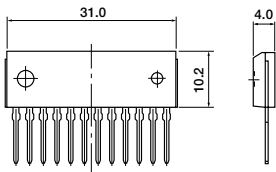

SMA15pin

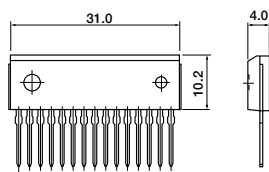

SLA12pin

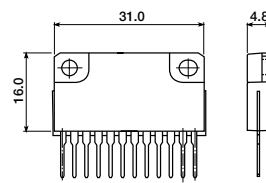

SLA15pin

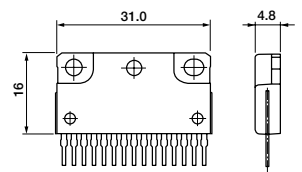

SLA18pin

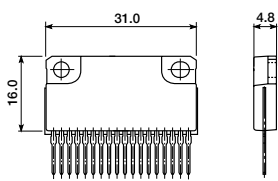

3GR-F

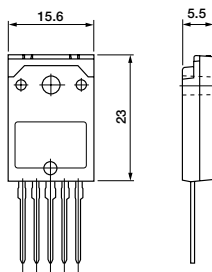

3GR-M

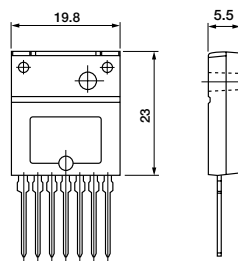

STR-S

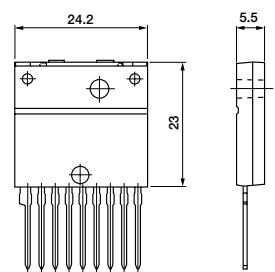

SPM

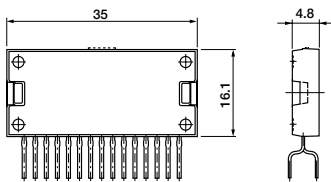

SMD16pin

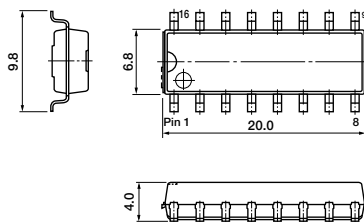

SPF16pin

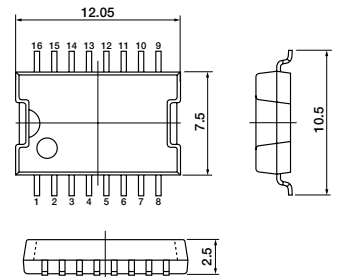

SPF20pin

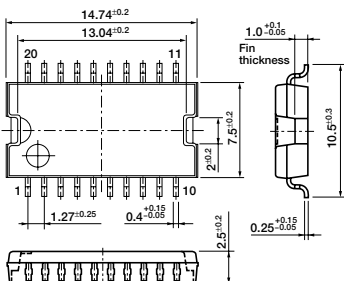

SPF24pin

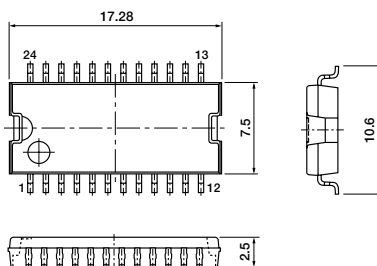

2

Discretetes

2-1. Transistors

2-1-1. Transistors	80
2SA1488/1488A (-60V/-4A, -80V/-4A)	80
2SA1567 (-50V/-12A)	81
2SA1568 (-60V/±12A)	82
2SA1908 (-120V/-8A)	83
2SB1622 (-200V/-15A)	84
2SC3852 (60V/3A)	85
2SC4024 (50V/10A)	86
2SC4065 (60V/±12A)	87
2SC4153 (120V/7A)	88
2SD2141 (380±50V/6A)	89
2SD2382 (60±5V/±6A)	90
2SD2633 (150V/8A)	91
FP812 (-100V/-8A)	92
MN611S (115±10V/±6A)	93
MN638S (380±50V/6A)	94
SSD103 (65±5V/±6A, Surface-mount)	95
2-1-2. Transistor Arrays	96
SDA03 (-60V/-6A, Surface-mount 4-circuits)	96
SDA04 (-60V/-6A, Surface-mount 2-circuits)	97
SDC09 (65±5V/6A, Surface-mount 2-circuits)	98
SLA8004 (60V/12A, -55V/-12A, H-bridge)	99
SPF0001 (115±10V/±6A, Surface-mount 2-circuits)	100
STA315A (35±5V/2A, 3-circuits)	101
STA335A (35±5V/3A, 2-circuits)	102
STA415A (35±5V/2A, 4-circuits)	103
STA460C (60±10V/±6A, 2-circuits)	104
STA461C (65±5V/±6A, 2-circuits)	105
STA463C (115±10V/±6A, 2-circuits)	106
STA464C (65±5V/6A, 4-circuits)	107

2-2. MOS FETs

2-2-1. MOS FETs	108
2SK3710 (60V/70A/6mΩ, Surface-mount) ...	108
2SK3711 (60V/70A/6mΩ)	109
2SK3724 (60V/80A/5mΩ, Surface-mount) ...	110
2SK3800 (40V/70A/6mΩ, Surface-mount) ...	111
2SK3801 (40V/70A/6mΩ)	112
2SK3803 (40V/85A/3mΩ, Surface-mount) ...	113
2SK3851 (60V/85A/4.7mΩ)	114
FKV460S (40V/60A/9mΩ, Surface-mount) ...	115
FKV660S (60V/60A/14mΩ, Surface-mount) ...	116
2-2-2. MOS FET Arrays	117
SDK06 (52±5V/3A/0.25Ω, Surface-mount 4-circuits)	117
SDK08 (50V/4.5A/0.08Ω, Surface-mount 4-circuits)	118
SDK09 (12V/6A/0.2Ω, Surface-mount 4-circuits)	119
SLA5027 (60V/12A/0.08Ω, 4-circuits)	120
SLA5098 (40V/20A/0.017Ω, 6-circuits)	121
SMA5113 (450V/7A/1.1Ω, 4-circuits)	122
STA508A (120V/6A/0.2Ω, 4-circuits)	123
STA509A (52±5V/3A/0.25Ω, 4-circuits)	124

2-3 Thyristors

2-3-1. Reverse Conducting Thyristors ...	125
TFC561D (600V, 430A, 1200A/μs)	125
TFC562D (600V, 600A, 1600A/μs)	126

2-4. Diodes

2-4-1. Alternator Diodes	127
2-4-2. High-voltage Diodes for Igniter ...	128
2-4-3. Power Zener Diodes	129
2-4-4. General-purpose Diodes	130

Power Transistor 2SA1568

Absolute Maximum Ratings (Ta=25°C)

Symbol	Ratings	Unit
V _{CB0}	-60	V
V _{CE0}	-60	V
V _{EB0}	-6	V
I _C	±12	A
I _B	-3	A
P _C	35 (T _C =25°C)	W
T _J	150	°C
T _{stg}	-55 to +150	°C

Electrical Characteristics (Ta=25°C)

Symbol	Test Conditions	Ratings	Unit
I _{CB0}	V _{CB} = -60V	-100max	μA
I _{EB0}	V _{EB} = -6V	-60max	mA
V _{(BR) CEO}	I _C = -25mA	-60min	V
h _{FE}	V _{CE} = -1V, I _C = -6A	50min	
V _{CE(sat)}	I _C = -6A, I _B = -0.3A	-0.35max	V
V _{FEC}	I _{ECO} = -10A	-2.5max	V
f _T	V _{CE} = -12V, I _E = 0.5A	40typ	MHz
COB	V _{CB} = -10V, f = 1MHz	330typ	pF

Typical Switching Characteristics (common emitter)

V _{CC} (V)	R _L (Ω)	I _C (A)	V _{BB1} (V)	V _{BB2} (V)	I _{B1} (mA)	I _{B2} (mA)	t _{on} (μs)	t _{stg} (μs)	t _f (μs)
-24	4	-6	-10	5	-120	120	0.4typ	0.4typ	0.2typ

External Dimensions TO220F (full-mold)

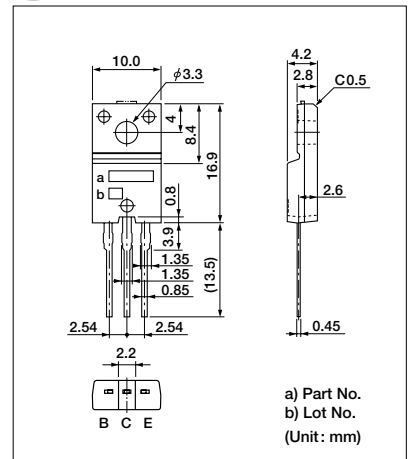

I_C—V_{CE} Characteristics (typ.)

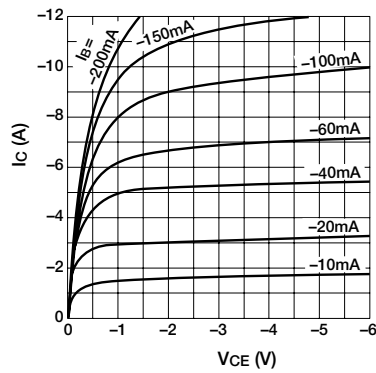

V_{CE(sat)}—I_B Characteristics (typ.)

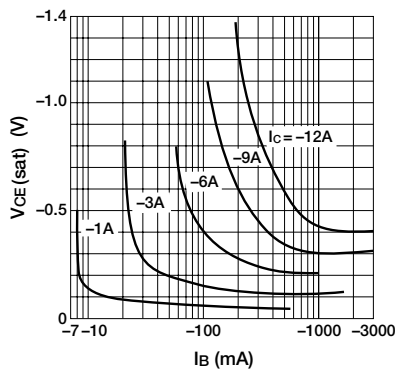

I_C—V_{BE} Temperature Characteristics (typ.)

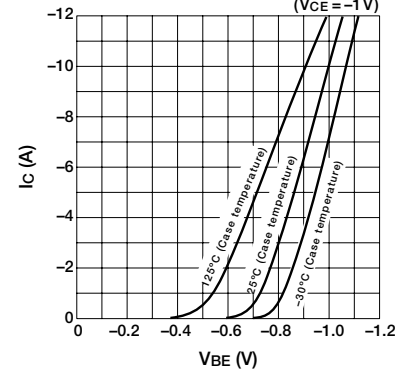

h_{FE}—I_C Characteristics (typ.)

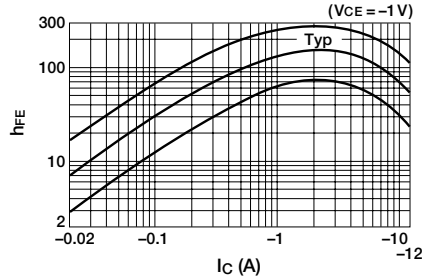

h_{FE}—I_C Temperature Characteristics (typ.)

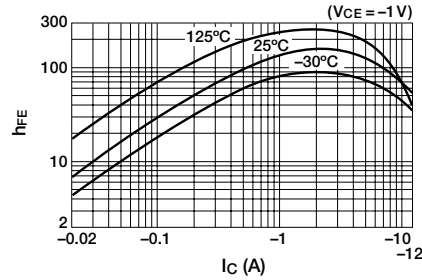

θ_{j-a}—t Characteristics

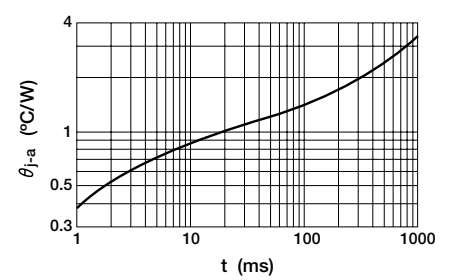

f_T—I_E Characteristics (typ.)

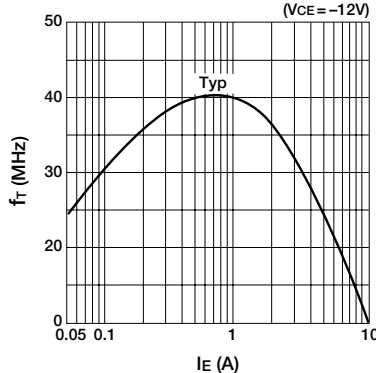

Safe Operating Area (single pulse)

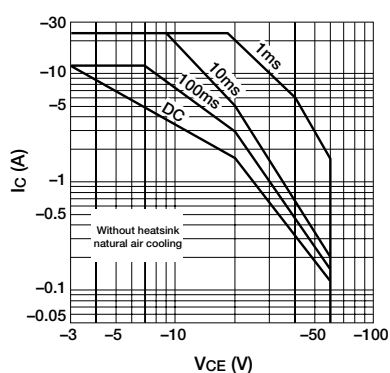

P_C—T_a Derating

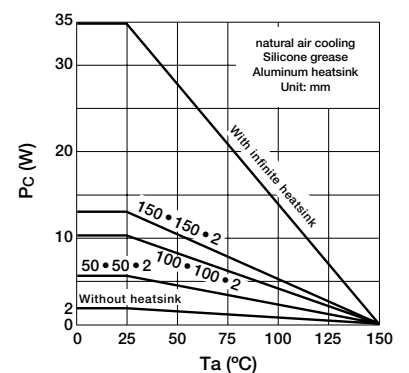

Power Transistor 2SA1908

Absolute Maximum Ratings (Ta=25°C)

Symbol	Rating	Unit
V _{CB0}	-120	V
V _{CE0}	-120	V
V _{EB0}	-6	V
I _C	-8	A
I _B	-3	A
P _C	75 (T _C =25°C)	W
T _J	150	°C
T _{stg}	-55 to +150	°C

Electrical Characteristics (Ta=25°C)

Symbol	Test Conditions	Rating	Unit
I _{CB0}	V _{CB} = -120V	-10max	μA
I _{EB0}	V _{EB} = -6V	-10max	μA
V _{(BR)CEO}	I _C = -50mA	-120min	V
h _{FE} *	V _{CE} = -4V, I _C = -3A	50min	
V _{CE(sat)}	I _C = -3A, I _B = -0.3A	-0.5max	V
f _T	V _{CE} = -12V, I _E = 0.5A	20typ	MHz
C _{OB}	V _{CB} = -10V, f = 1MHz	300typ	pF

* Rank: O (50 to 100), P (70 to 140), Y (90 to 180)

Typical Switching Characteristics (common emitter)

V _{CC} (V)	R _L (Ω)	I _C (A)	V _{BB1} (V)	V _{BB2} (V)	I _{B1} (mA)	I _{B2} (mA)	t _{on} (μs)	t _{stg} (μs)	t _f (μs)
-40	10	-4	-10	5	-400	400	0.14typ	1.40typ	0.21typ

External Dimensions FM100 (T03PF)

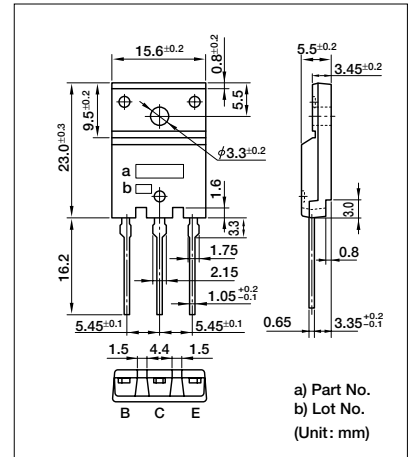

I_C—V_{CE} Characteristics (typ.)

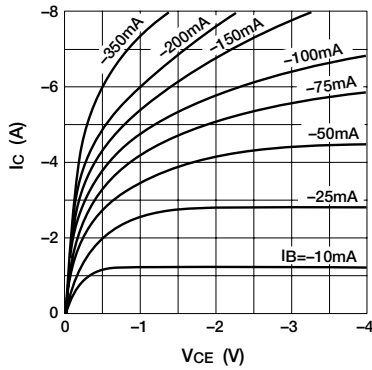

V_{CE(sat)}—I_B Characteristics (typ.)

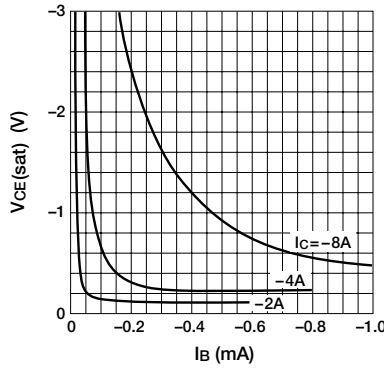

I_C—V_{BE} Temperature Characteristics (typ.)

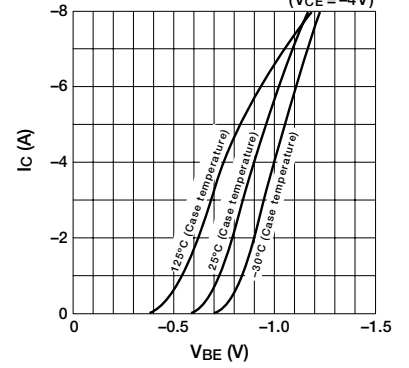

h_{FE}—I_C Characteristics (typ.)

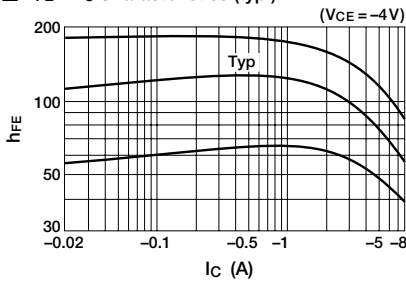

h_{FE}—I_C Temperature Characteristics (typ.)

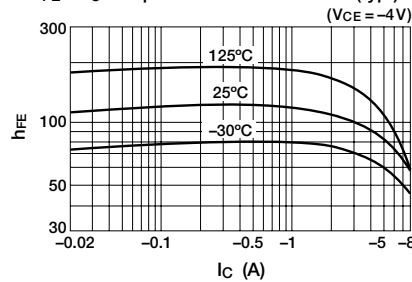

θ_{J-a}—t Characteristics

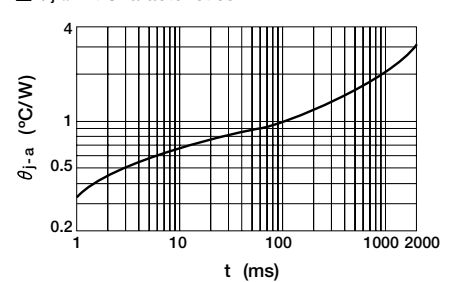

f_T—I_E Characteristics (typ.)

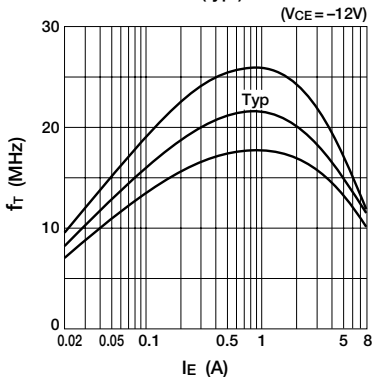

Safe Operating Area (single pulse)

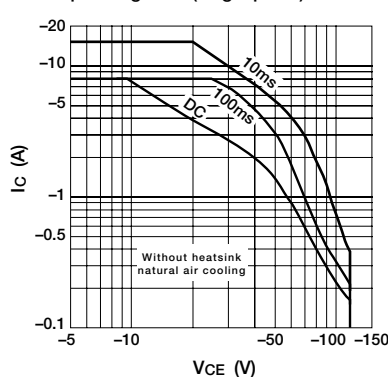

P_C—T_a Derating

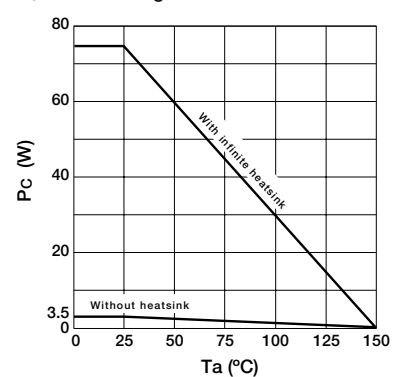

Power Transistor 2SB1622

Absolute Maximum Ratings (Ta=25°C)

Symbol	Ratings	Unit
V _{CB0}	-200	V
V _{CE0}	-200	V
V _{EB0}	-5	V
I _C	-15	A
I _B	-1	A
P _C	85 (T _C =25°C)	W
T _J	150	°C
T _{stg}	-55 to +150	°C

Electrical Characteristics (Ta=25°C)

Symbol	Test Conditions	Ratings			Unit
		min	typ	max	
I _{CB0}	V _{CB} = -200V			-100	μA
I _{EB0}	V _{EB} = -5V			-100	μA
V _{CE0}	I _C = -30mA	-200			V
h _{FE} *	V _{CE} = -4V, I _C = -10A	5000		30000	
V _{CE(sat)}	I _C = -10A, I _B = -10mA			-2.5	V
V _{BE(sat)}	I _C = -10A, I _B = -10mA			-3.0	V
f _T	V _{CE} = -12V, I _E = 2A		60		MHz
C _{OB}	V _{CB} = -10V, f = 1MHz		270		pF

*Rank: O(5000 to 12000), P(6500 to 20000), Y(15000 to 30000)

Typical Switching Characteristics

V _{CC} (V)	R _L (Ω)	I _C (A)	V _{BB1} (V)	V _{BB2} (V)	I _{B1} (mA)	I _{B2} (mA)	t _{on} (μs)	t _{stg} (μs)	t _f (μs)
-40	4	-10	-10	5	-10	10	0.4typ	3.6typ	1.0typ

External Dimensions

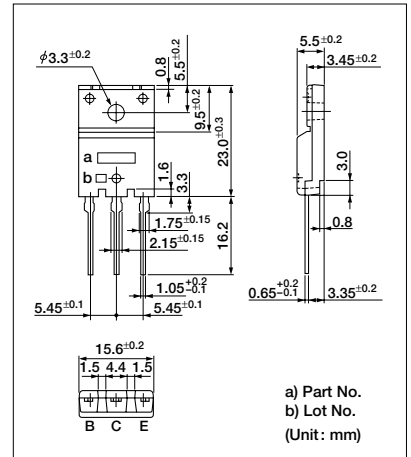

■ I_C—V_{CE} Characteristics (typ.)

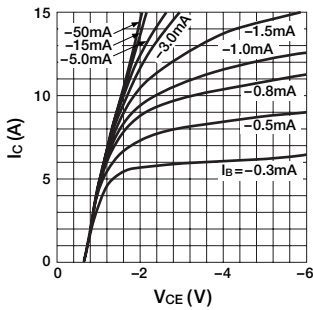

■ V_{CE(sat)}—I_B Characteristics (typ.)

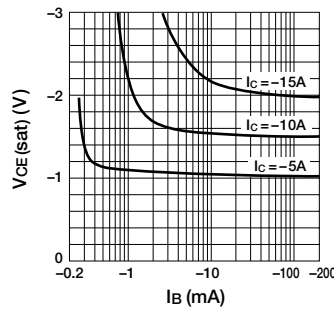

■ V_{CE(sat)}—I_B Temperature Characteristics (typ.)

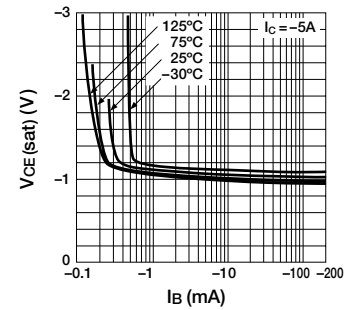

■ V_{CE(sat)}—I_B Temperature Characteristics (typ.)

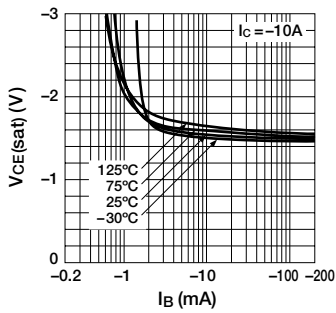

■ I_C—V_{BE} Temperature Characteristics (typ.)

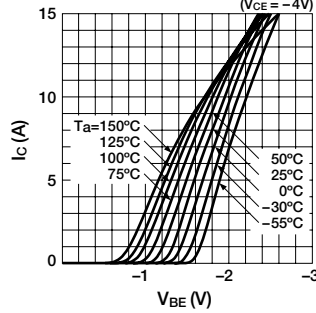

■ h_{FE}—I_C Characteristics (typ.)

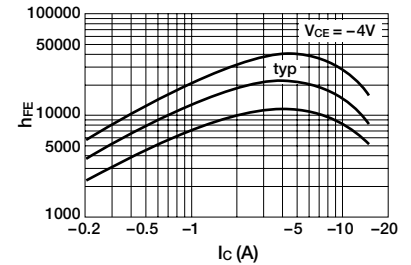

■ h_{FE}—I_C Temperature Characteristics (typ.)

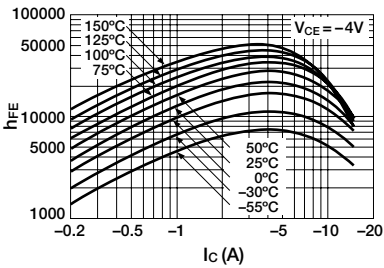

■ t_{on}·t_{stg}·t_f—I_C Characteristics (typ.)

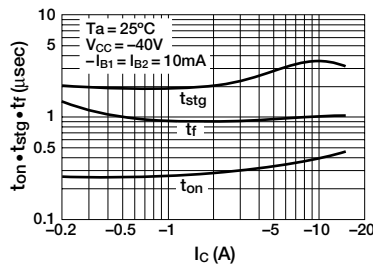

■ θ_{j-a}—t Characteristics

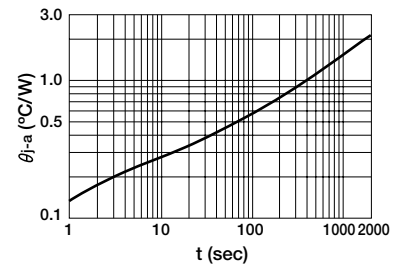

■ f_T—I_E Characteristics (typ.)

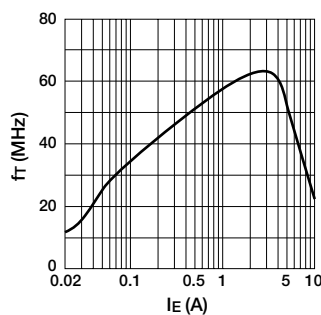

■ Safe Operating Area

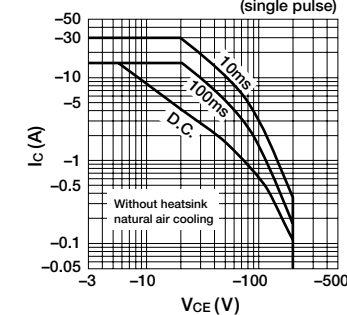

■ P_C—T_a Derating

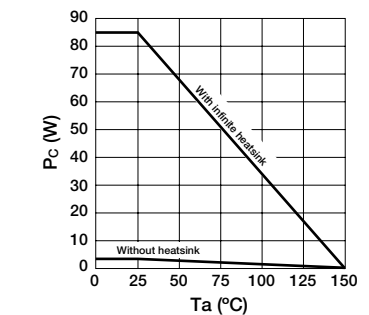

Power Transistor 2SC3852

Absolute Maximum Ratings (Ta=25°C)

Symbol	Rating	Unit
V _{CB0}	80	V
V _{CE0}	60	V
V _{EB0}	6	V
I _C	3	A
I _B	1	A
P _C	25 (T _C =25°C)	W
T _J	150	°C
T _{stg}	-55 to +150	°C

Electrical Characteristics (Ta=25°C)

Symbol	Test Conditions	Rating	Unit
I _{CB0}	V _{CB} = 80V	10max	μA
I _{EB0}	V _{EB} = 6V	100max	μA
V _{(BR)CEO}	I _C = 25mA	60min	V
h _{FE}	V _{CE} = 4V, I _C = 0.5A	500min	
V _{CE(sat)}	I _C = 2A, I _B = 50mA	0.5max	V
f _T	V _{CE} = 12V, I _E = -0.2A	15typ	MHz
COB	V _{CB} = 10V, f = 1MHz	50typ	pF

Typical Switching Characteristics (common emitter)

V _{CC} (V)	R _L (Ω)	I _C (A)	V _{BB1} (V)	V _{BB2} (V)	I _{B1} (mA)	I _{B2} (mA)	t _{on} (μs)	t _{stg} (μs)	t _f (μs)
20	20	1.0	10	-5	15	-30	0.8typ	3.0typ	1.2typ

External Dimensions TO220F (full-mold)

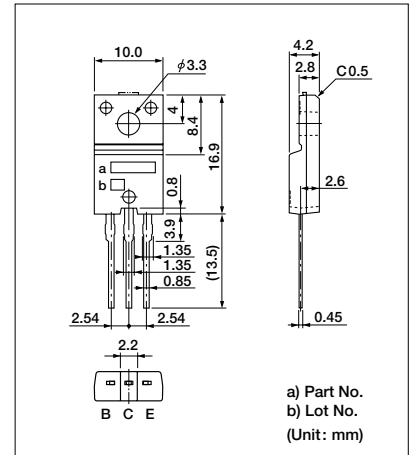

■ I_C—V_{CE} Characteristics (typ.)

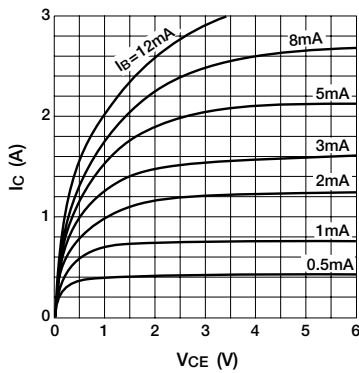

■ V_{CE(sat)}—I_B Characteristics (typ.)

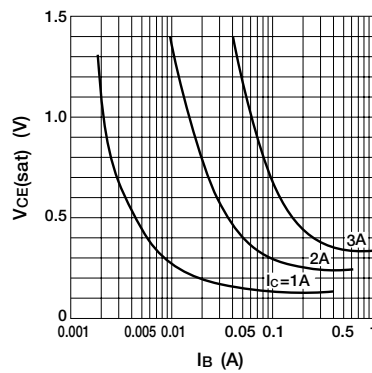

■ I_C—V_{BE} Temperature Characteristics (typ.)

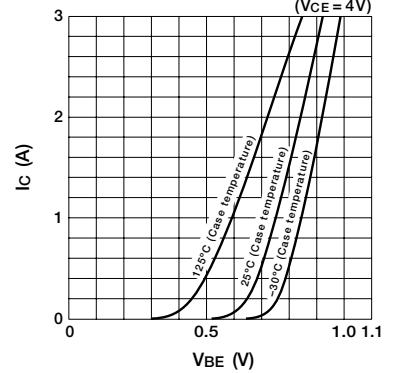

■ h_{FE}—I_C Characteristics (typ.)

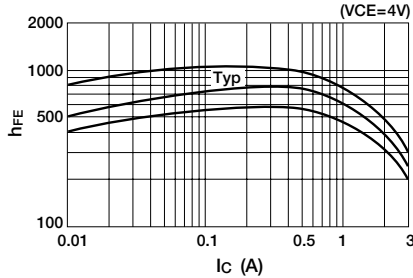

■ h_{FE}—I_C Temperature Characteristics (typ.)

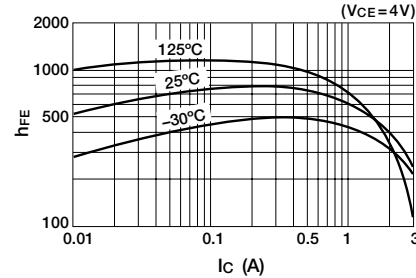

■ θ_{J-a}—t Characteristics

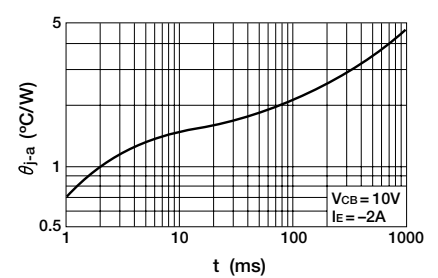

■ f_T—I_E Characteristics (typ.)

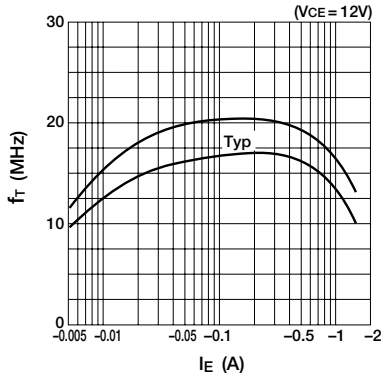

■ Safe Operating Area (single pulse)

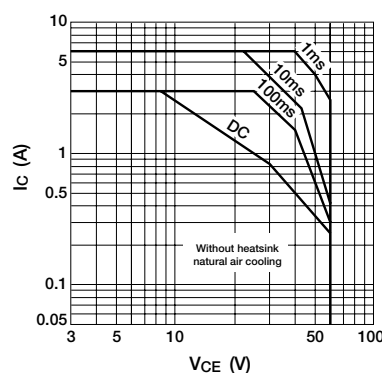

■ P_C—T_a Derating

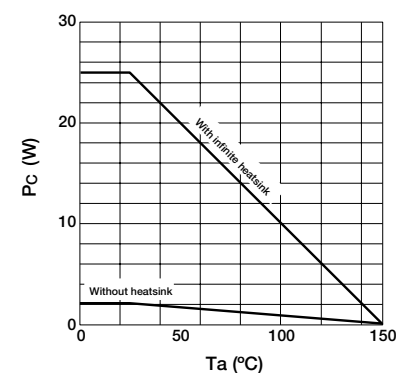

Power Transistor 2SC4024

Absolute Maximum Ratings (Ta=25°C)

Symbol	Rating	Unit
V _{CB0}	100	V
V _{CEO}	50	V
V _{EB0}	15	V
I _C	10	A
I _B	3	A
P _C	35 (T _C =25°C)	W
T _J	150	°C
T _{stg}	-55 to +150	°C

Electrical Characteristics (Ta=25°C)

Symbol	Test Conditions	Rating	Unit
I _{CB0}	V _{CB} = 100V	10max	μA
I _{EB0}	V _{EB} = 15V	10max	μA
V _{(BR) CEO}	I _C = 25 mA	50min	V
h _{FE}	V _{CE} = 4V, I _C = 1A	300 to 1600	
V _{CE(sat)}	I _C = 5A, I _B = 0.1A	0.5max	V
f _T	V _{CB} = 12V, I _E = -0.5A	24typ	MHz
COB	V _{CB} = 10V, f = 1MHz	150typ	pF

Typical Switching Characteristics (common emitter)

V _{CC} (V)	R _L (Ω)	I _C (A)	I _{B1} (A)	I _{B2} (A)	t _{on} (μs)	t _{stg} (μs)	t _f (μs)
20	4	5	0.1	-0.1	0.5typ	2.0typ	0.5typ

External Dimensions TO220F (full-mold)

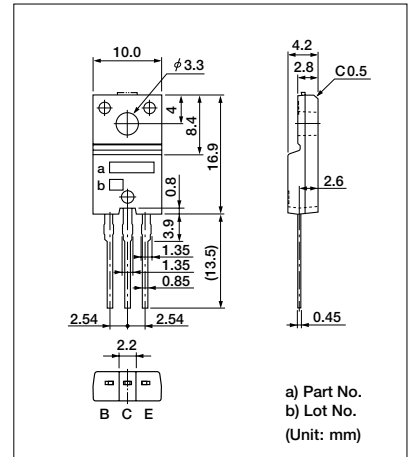

■ I_C—V_{CE} Characteristics (typ.)

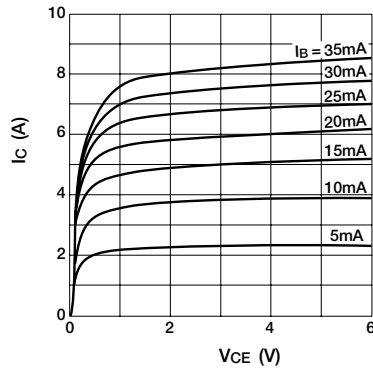

■ V_{CE(sat)}—I_B Characteristics (typ.)

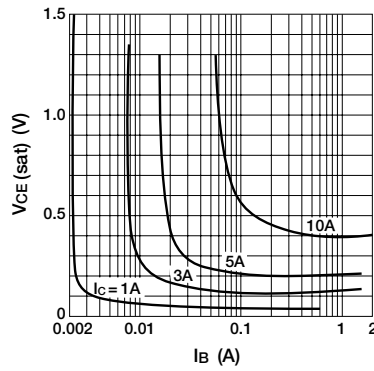

■ I_C—V_{BE} Temperature Characteristics (typ.)

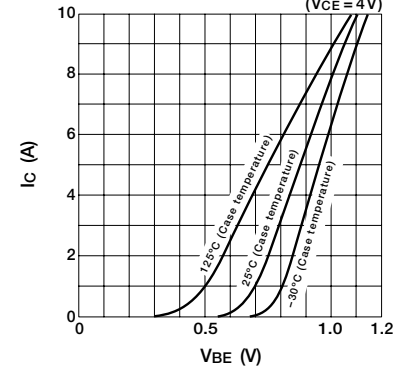

■ h_{FE}—I_C Characteristics (typ.)

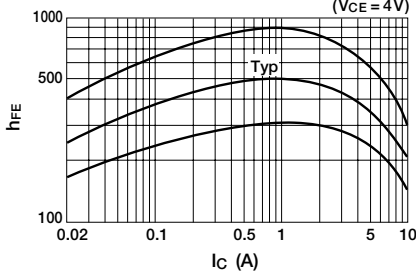

■ h_{FE}—I_C Temperature Characteristics (typ.)

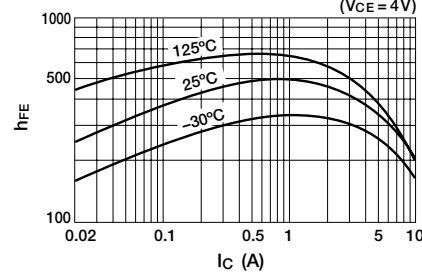

■ θ_{J-a}—t Characteristics

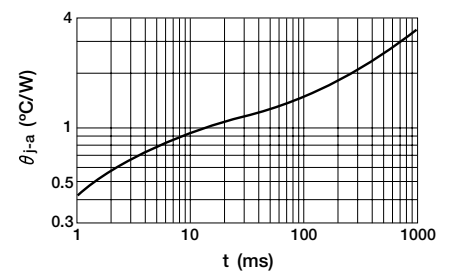

■ f_T—I_E Characteristics (typ.)

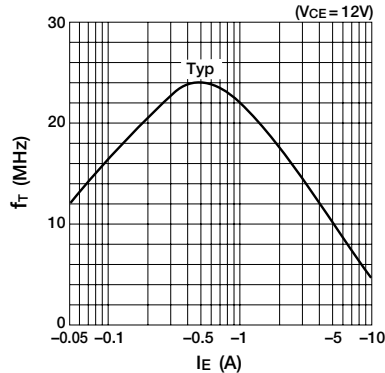

■ Safe Operating Area (single pulse)

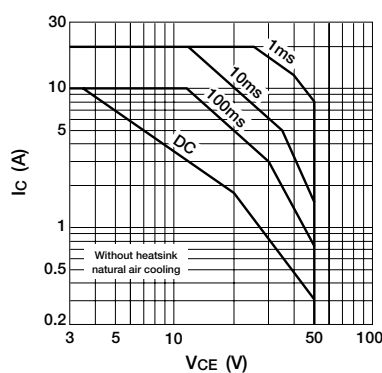

■ P_C—T_a Derating

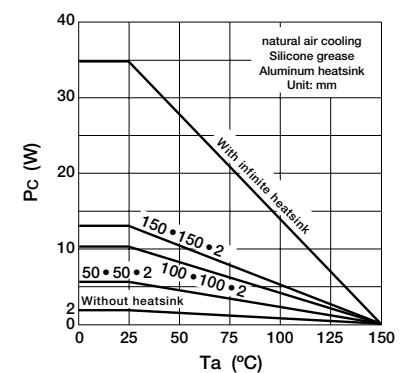

Power Transistor 2SC4065

Absolute Maximum Ratings (Ta=25°C)

Symbol	Ratings	Unit
V _{CB0}	60	V
V _{CE0}	60	V
V _{EB0}	6	V
I _C	±12	A
I _B	3	A
P _C	35 (T _c =25°C)	W
T _J	150	°C
T _{stg}	-55 to +150	°C

Electrical Characteristics (Ta=25°C)

Symbol	Test Conditions	Ratings	Unit
I _{CBO}	V _{CB} = 60V	100max	μA
I _{EBO}	V _{EB} = 6V	60max	mA
V _{(BR)CEO}	I _C = 25mA	60min	V
h _{FE}	V _{CE} = 1V, I _C = 6A	50min	
V _{CE(sat)}	I _C = 6A, I _B = 1.3A	0.35max	V
V _{FEC}	V _{ECO} = 10A	2.5max	V
f _T	V _{CE} = 12V, I _E = -0.5A	24typ	MHz
COB	V _{CB} = 10V, f = 1MHz	180typ	pF

Typical Switching Characteristics (common emitter)

V _{CC} (V)	R _L (Ω)	I _C (A)	V _{BB1} (V)	V _{BB2} (V)	I _{B1} (A)	I _{B2} (A)	t _{on} (μs)	t _{stg} (μs)	t _f (μs)
24	4	6	10	-5	0.12	-0.12	0.6typ	1.4typ	0.4typ

External Dimensions TO220F (full-mold)

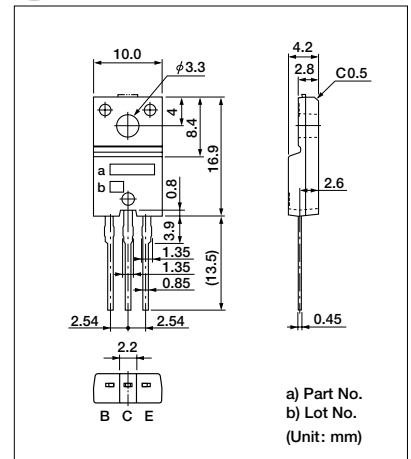

■ I_C—V_{CE} Characteristics (typ.)

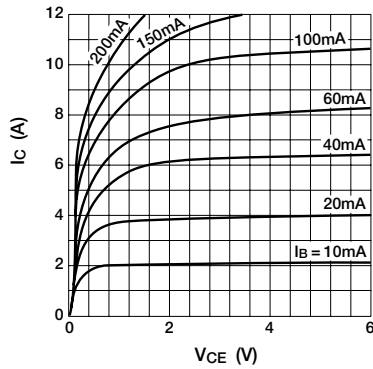

■ V_{CE(sat)}—I_B Characteristics (typ.)

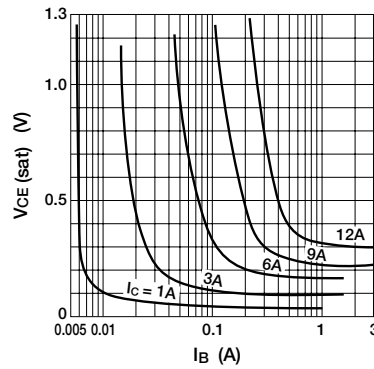

■ I_C—V_{BE} Temperature Characteristics (typ.)

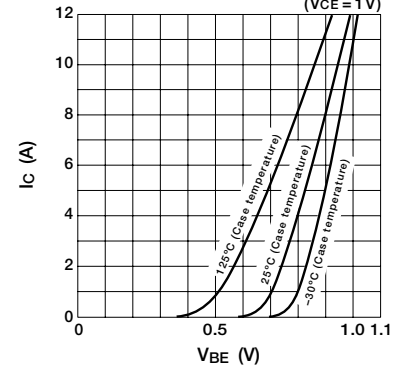

■ h_{FE}—I_C Characteristics (typ.)

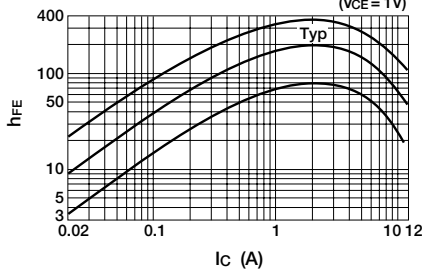

■ h_{FE}—I_C Temperature Characteristics (typ.)

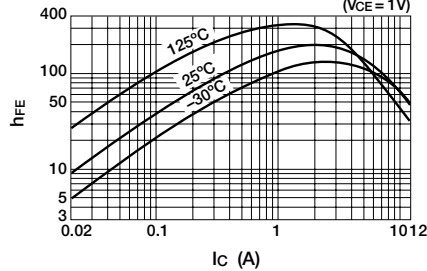

■ θ_{J-a}—t Characteristics

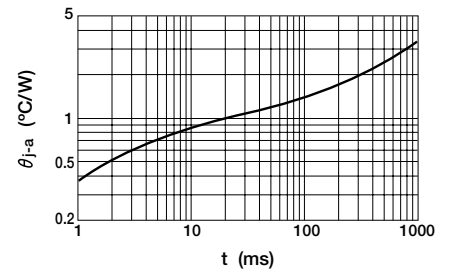

■ f_T—I_E Characteristics (typ.)

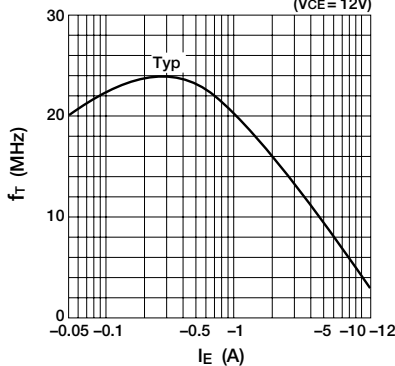

■ Safe Operating Area (single pulse)

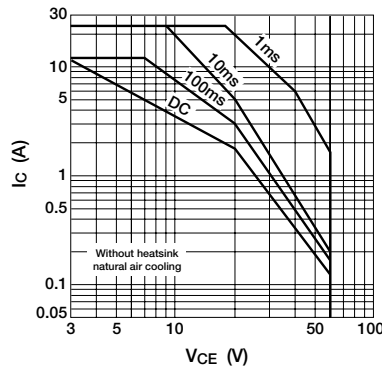

■ P_C—T_a Derating

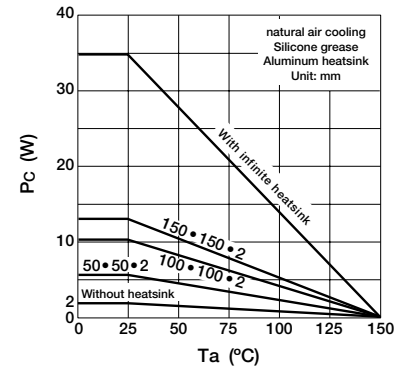

Power Transistor 2SC4153

Absolute Maximum Ratings (Ta=25°C)

Symbol	Rating	Unit
V _{CB0}	200	V
V _{CE0}	120	V
V _{EB0}	8	V
I _c	7 (pulse 14)	A
I _B	3	A
P _C	30 (T _c =25°C)	W
T _J	150	°C
T _{stg}	-55 to +150	°C

Electrical Characteristics (Ta=25°C)

Symbol	Test Conditions	Rating	Unit
I _{CB0}	V _{CB} = 200V	100max	μA
I _{EB0}	V _{EB} = 8V	100max	μA
V _{(BR) CEO}	I _c = 50mA	120min	V
h _{FE}	V _{CE} = 4V, I _c = 3A	70 to 220	
V _{CE(sat)}	I _c = 3A, I _B = 0.3A	0.5max	V
V _{BE(sat)}	I _c = 3A, I _B = 0.3A	1.2max	V
f _T	V _{CE} = 12V, I _E = -0.5A	30typ	MHz
COB	V _{CB} = 10V, f = 1MHz	110typ	pF

Typical Switching Characteristics (common emitter)

V _{CC} (V)	R _L (Ω)	I _c (A)	V _{BB1} (V)	V _{BB2} (V)	I _{B1} (A)	I _{B2} (A)	t _{on} (μs)	t _{stg} (μs)	t _f (μs)
50	16.7	3	10	-5	0.3	-0.6	0.5max	3max	0.5max

External Dimensions TO220F (full-mold)

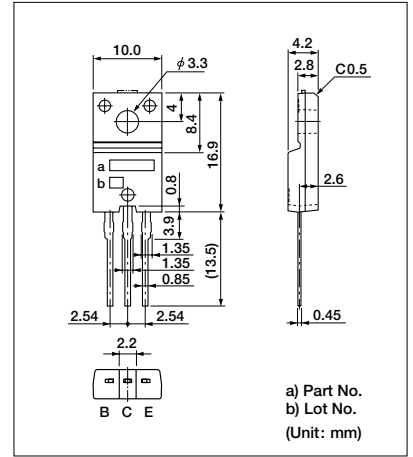

■ I_c—V_{CE} Characteristics (typ.)

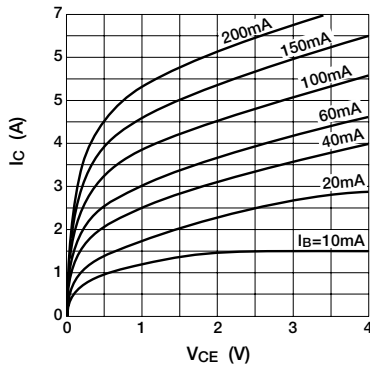

■ V_{CE(sat)}—I_B Characteristics (typ.)

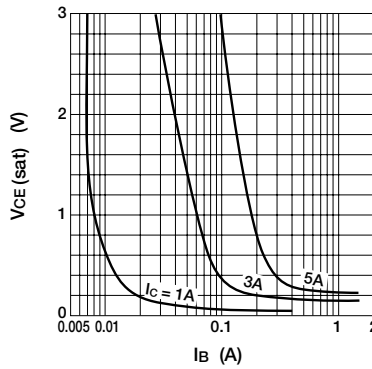

■ I_c—V_{BE} Temperature Characteristics (typ.)

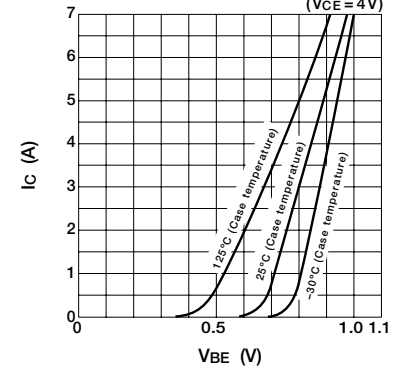

■ h_{FE}—I_c Characteristics (typ.)

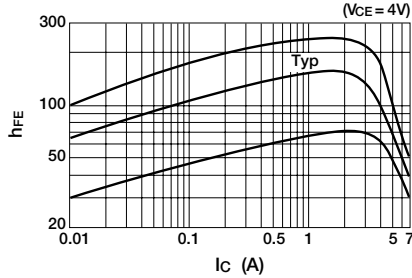

■ h_{FE}—I_c Temperature Characteristics (typ.)

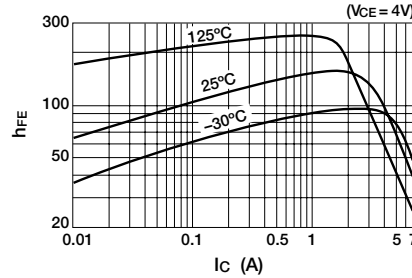

■ θ_{j-a}—t Characteristics

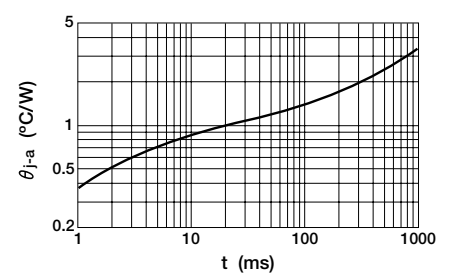

■ f_T—I_E Characteristics (typ.)

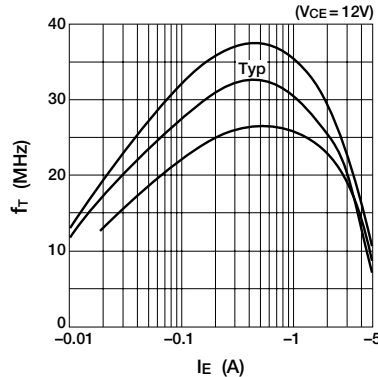

■ Safe Operating Area (single pulse)

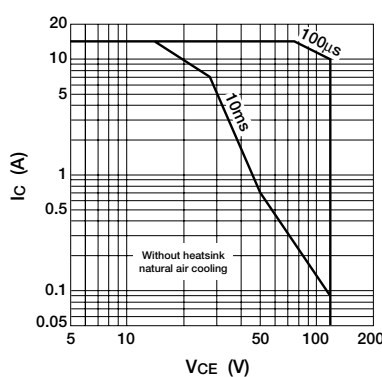

■ P_C—T_a Derating

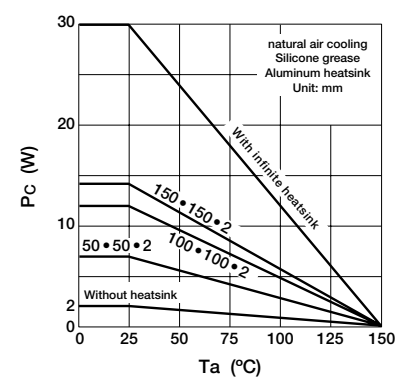

Power Transistor 2SD2141

Absolute Maximum Ratings (Ta=25°C)

Symbol	Rated	Unit
V _{CB0}	380±50	V
V _{CE0}	380±50	V
V _{EBO}	6	V
I _C	6 (pulse 10)	A
I _B	1	A
P _C	35 (T _C =25°C)	W
T _J	150	°C
T _{stg}	-55 to +150	°C

Electrical Characteristics (Ta=25°C)

Symbol	Test Conditions	Rated	Unit
I _{CB0}	V _{CB} = 330V	10max	μA
I _{EBO}	V _{EB} = 6V	20max	μA
V _{(BR)CEO}	I _C = 25mA	330 to 430	V
h _{FE}	V _{CE} = 2V, I _C = 3A	1500min	
V _{CE(sat)}	I _C = 4A, I _B = 20mA	1.5max	V

External Dimensions TO220F (full-mold)

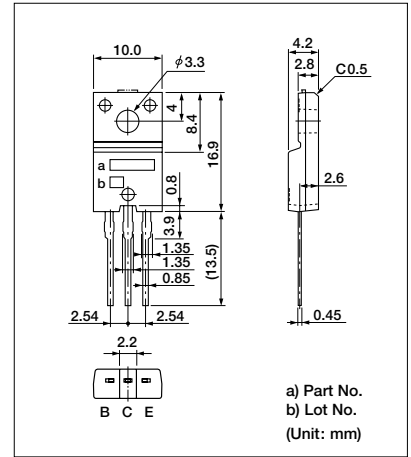

■ I_C—V_{CE} Characteristics (typ.)

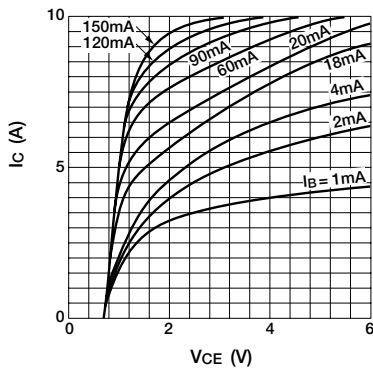

■ V_{CE(sat)}—I_B Characteristics (typ.)

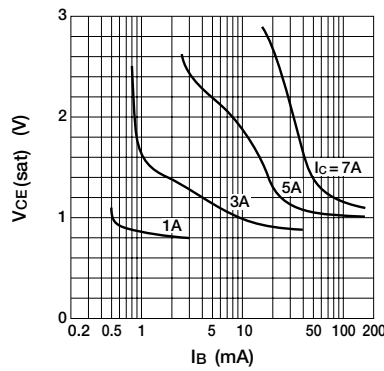

■ I_C—V_{BE} Temperature Characteristics (typ.)

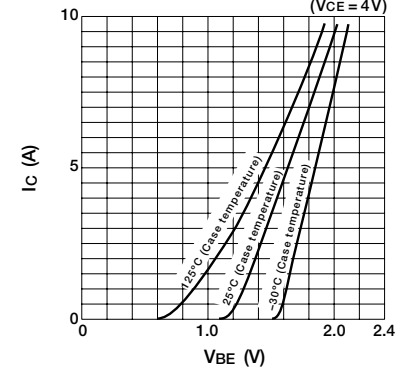

■ h_{FE}—I_C Characteristics (typ.)

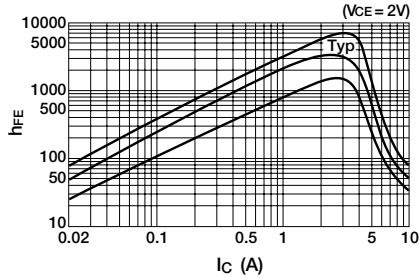

■ h_{FE}—I_C Temperature Characteristics (typ.)

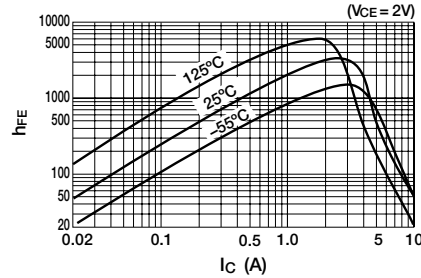

■ θ_{J-a}—t Characteristics

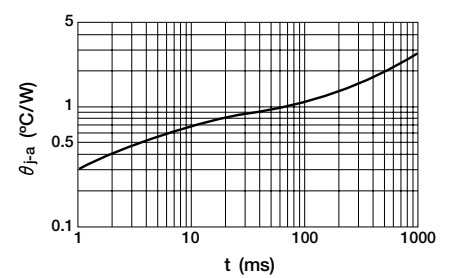

■ f_T—I_E Characteristics (typ.)

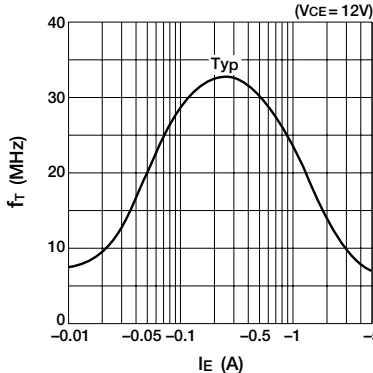

■ Safe Operating Area (single pulse)

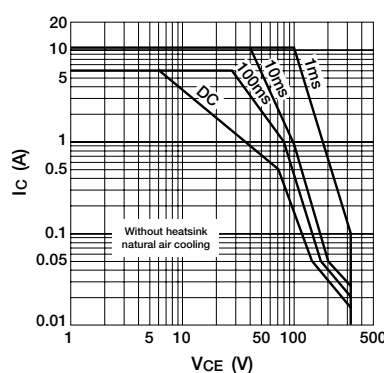

■ P_C—T_a Derating

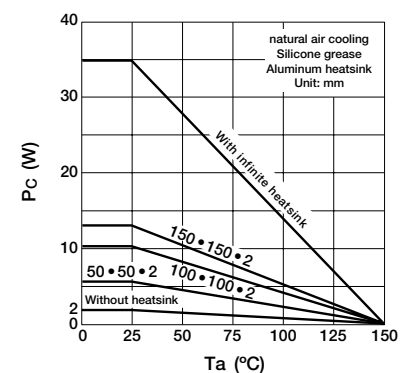

Power Transistor 2SD2382

Absolute Maximum Ratings (Ta=25°C)

Symbol	Rating	Unit
V _{CB0}	65±5	V
V _{CE0}	65±5	V
V _{EB0}	6	V
I _C	±6 (pulse ±10)	A
I _B	1	A
P _C	30 (T _C =25°C)	W
T _J	150	°C
T _{stg}	-55 to +150	°C

Electrical Characteristics (Ta=25°C)

Symbol	Test Conditions	Rating	Unit
I _{CB0}	V _{CB} = 60V	10max	μA
I _{EB0}	V _{EB} = 6V	10max	μA
V _{CE0}	I _C = 50mA	60 to 70	V
h _{FE}	V _{CE} = 1V, I _C = 1A	700 to 3000	
V _{CE(sat)}	I _C = 1.5A, I _B = 15mA	0.15max	V
V _{FEC}	I _{FEC} = 6A	1.5max	V
Es/b	L = 10mH, single pulse	200min	mJ

Typical Switching Characteristics

V _{CC} (V)	R _L (Ω)	I _C (A)	V _{BB1} (V)	V _{BB2} (V)	I _{B1} (mA)	I _{B2} (mA)	t _{on} (μs)	t _{stg} (μs)	t _f (μs)
12	12	1	10	-5	30	-30	0.25	0.8	0.35

External Dimensions TO220F (full-mold)

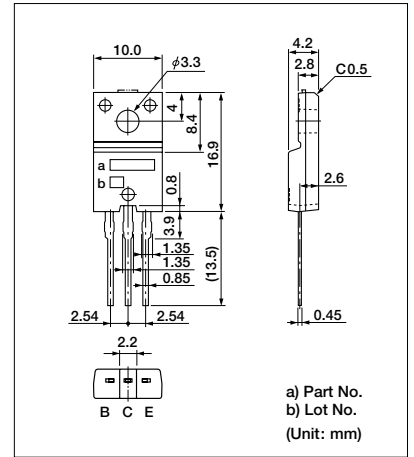

■ I_C—V_{CE} Characteristics (typ.)

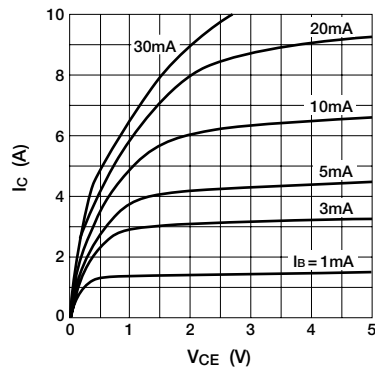

■ V_{CE(sat)}—I_B Temperature Characteristics (typ.)

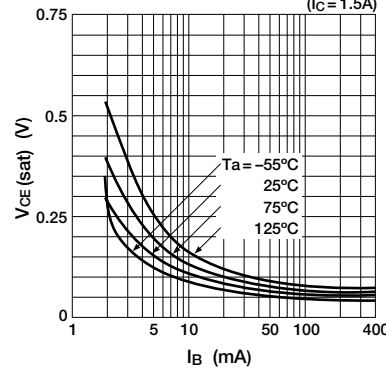

■ I_C—V_{BE} Temperature Characteristics (typ.)

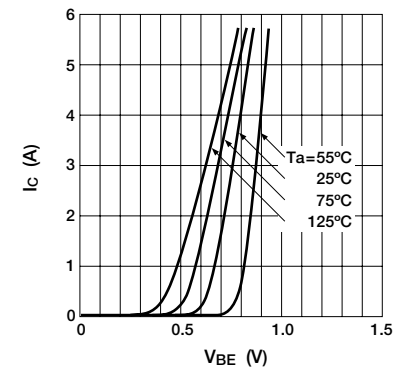

■ h_{FE}—I_C Characteristics (typ.)

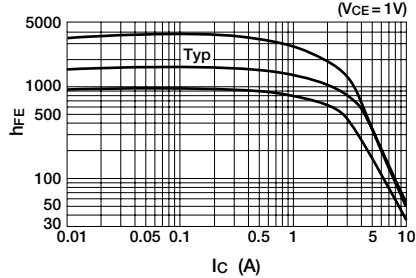

■ h_{FE}—I_C Temperature Characteristics (typ.)

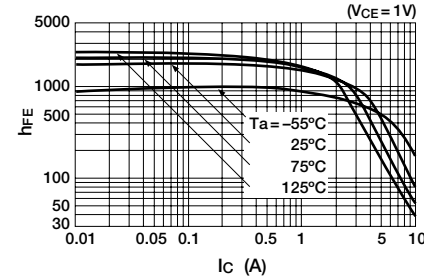

■ θ_{J-a}—t Characteristics

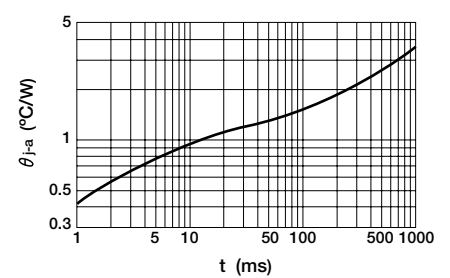

■ f_T—I_E Characteristics (typ.)

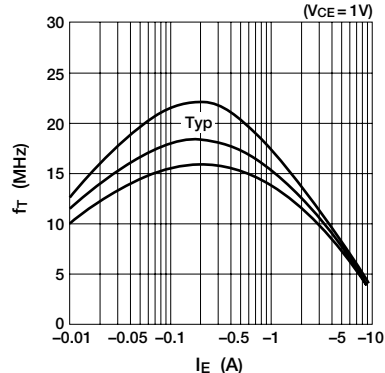

■ Safe Operating Area (single pulse)

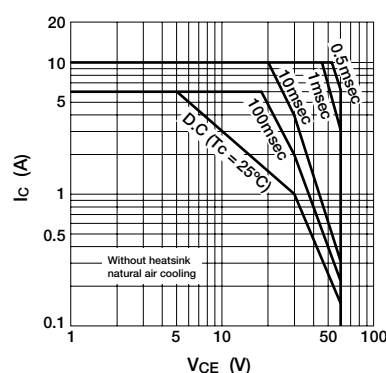

■ P_C—T_a Derating

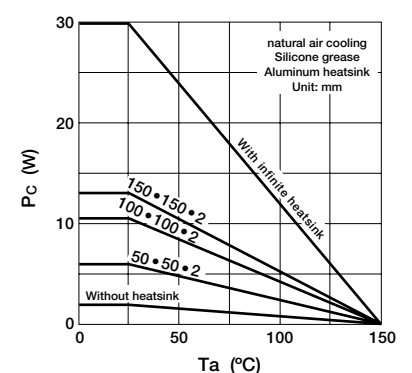

Power Transistor 2SD2633

Absolute Maximum Ratings (Ta=25°C)

Symbol	Ratings	Unit
V _{CB0}	200	V
V _{CE0}	150	V
V _{EBO}	6	V
I _C	8	A
I _B	1	A
P _C	35 (T _C =25°C) 2 (T _a =25°C, No Fin)	W
T _J	150	°C
T _{stg}	-55 to +150	°C

Electrical Characteristics (Ta=25°C)

Symbol	Test Conditions	Ratings	Unit
I _{CBO}	V _{CB} =200V	100max	μA
I _{EBO}	V _{EB} =6V	10max	mA
V _{CE0}	I _C =50mA	150min	V
h _{FE}	V _{CE} =2V, I _C =6A	2000min	
V _{CE (sat)}	I _C =6A, I _B =6mA	1.5max	V
V _{BE (sat)}	I _C =6A, I _B =6mA	2.0max	V

External Dimensions TO220F (full-mold)

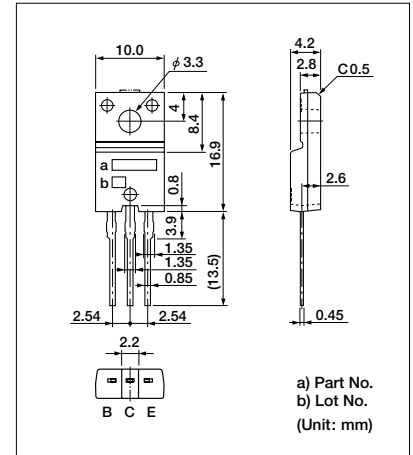

Power Transistor FP812

Absolute Maximum Ratings (Ta=25°C)

Symbol	Ratings	Unit
VcBo	-120	V
VcEO	-120	V
VEBO	-6	V
Ic	-8 (pulse -12)	A
Ib	-3	A
Pc	35 (Tc=25°C)	W
Tj	150	°C
Tstg	-55 to +150	°C

Electrical Characteristics (Ta=25°C)

Symbol	Test Conditions	Ratings	Unit
IcBo	VcB = -120V	10max	μA
IEBO	VEB = -6V	10max	μA
VcEO	Ic = -50mA	-120min	V
hFE	VCE = -4V, Ic = -3A	70min	
VCE(sat)	Ic = -3A, Ib = -0.3A	-0.3max	V

Typical Switching Characteristics

VCC (V)	RL (Ω)	Ic (A)	VBB1 (V)	VBB2 (V)	Ib1 (mA)	Ib2 (mA)	ton (μs)	tstg (μs)	tr (μs)
-12	4	-3	-10	5	-30	30	2.5	0.4	0.6

External Dimensions TO220F (full-mold)

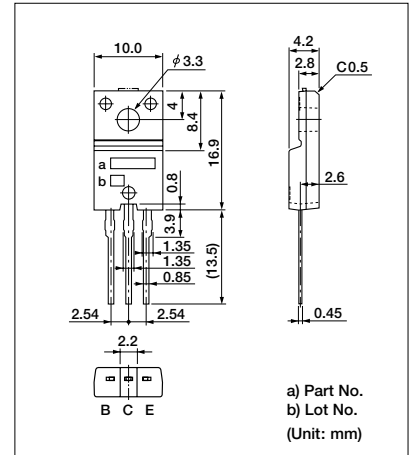

Ic—VCE Characteristics (typ.)

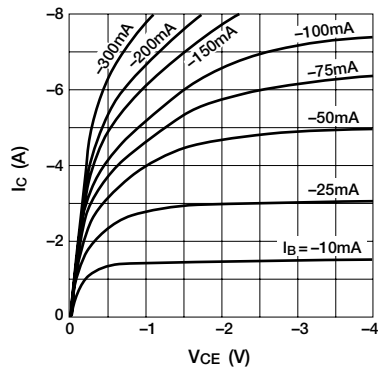

VCE (sat)—Ib Characteristics (typ.)

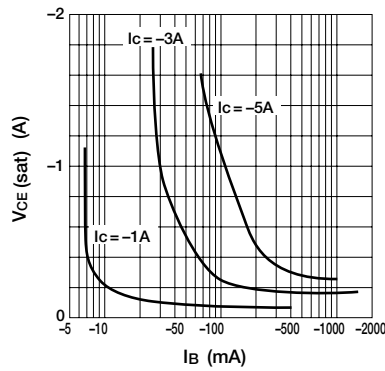

Ic—VBE Temperature Characteristics (typ.)

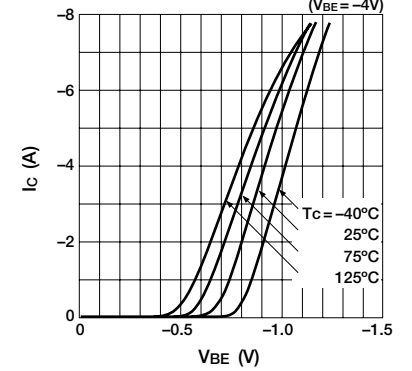

hFE—Ic Characteristics (typ.)

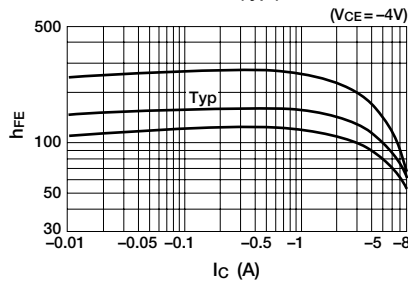

hFE—Ic Temperature Characteristics (typ.)

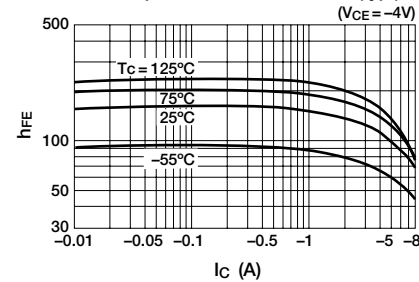

θj-a—t Characteristics

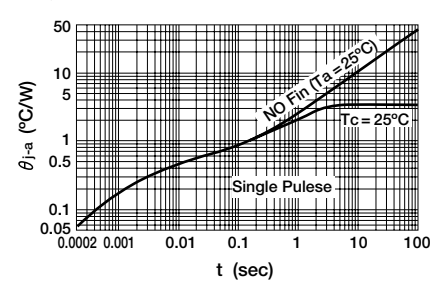

ft—Ic Characteristics (typ.)

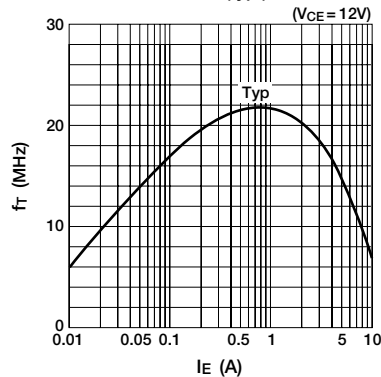

Safe Operating Area (single pulse)

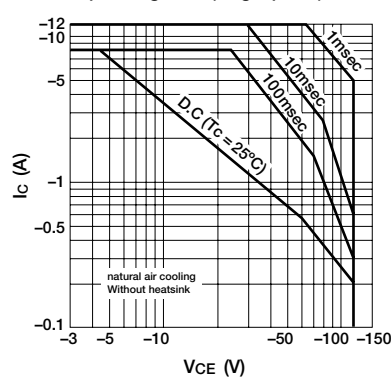

Pc—Ta Derating

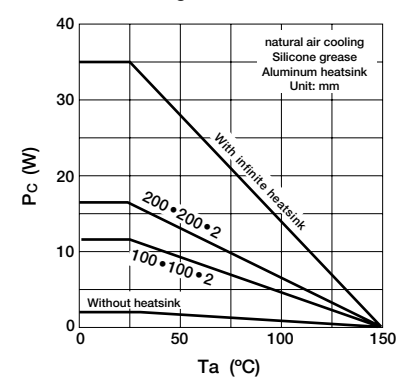

Power Transistor MN611S

Absolute Maximum Ratings (Ta=25°C)

Symbol	Rated	Unit
V _{CB0}	115±10	V
V _{CE0}	115±10	V
V _{EB0}	6	V
I _c	±6 (pulse ±10)	A
I _B	1	A
P _c	50 (T _c =25°C)	W
	1.2 (Ta=25°C, No Fin)	
T _J	150	°C
T _{stg}	-55 to +150	°C

Electrical Characteristics (Ta=25°C)

Symbol	Test Conditions	Ratings			Unit
		min	typ	max	
I _{CB0}	V _{CB} =105V			10	μA
I _{EB0}	V _{EB} =6V			10	μA
V _{CE0}	I _c =50mA	105	115	125	V
h _{FE}	V _{CE} =1V, I _c =1A	400	800	1500	
V _{CE (sat)}	I _c =1.2A, I _B =12mA		0.08	0.12	V
V _{FEC}	I _{FEC} =6A		1.25	1.5	V
ES/B	L=10mA	45			mJ

Typical Switching Characteristics

V _{CC} (V)	R _L (Ω)	V _{BB1} (V)	V _{BB2} (V)	I _c (A)	I _{B1} (mA)	I _{B2} (mA)	t _{on} (μs)	t _{stg} (μs)	t _f (μs)
12	12	10	-5	1	30	-30	0.2typ	5.7typ	0.4typ

External Dimensions T0220S

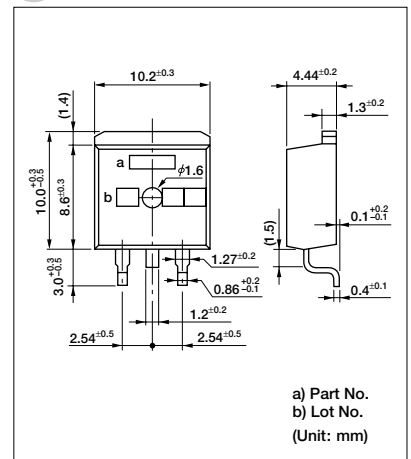

■ I_c—V_{CE} Characteristics (typ.)

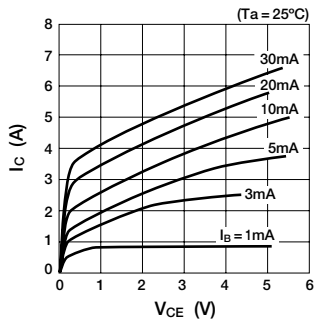

■ V_{CE (sat)}—I_B Characteristics (typ.)

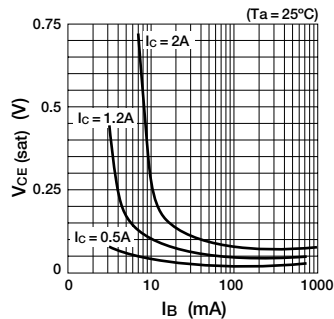

■ V_{CE (sat)}—I_B Temperature Characteristics (typ.)

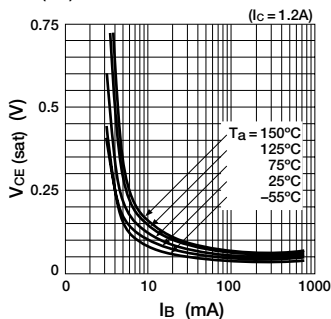

■ I_c—V_{BE} Temperature Characteristics (typ.)

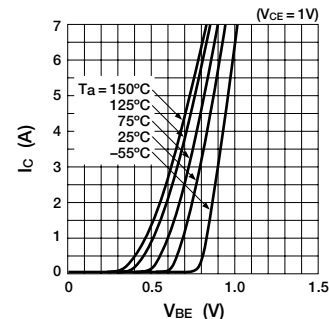

■ I_{FEC}—V_{FEC} Temperature Characteristics (typ.)

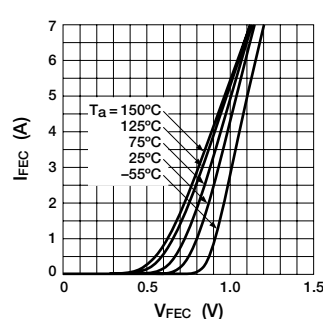

■ h_{FE}—I_c Characteristics (typ.)

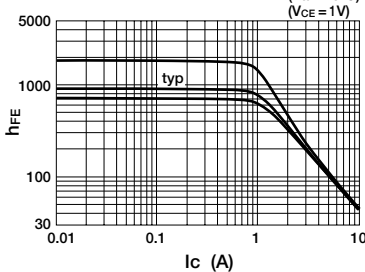

■ h_{FE}—I_c Temperature Characteristics (typ.)

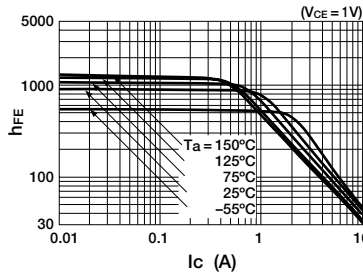

■ t_{on}•t_{stg}•t_f—I_c Characteristics (typ.)

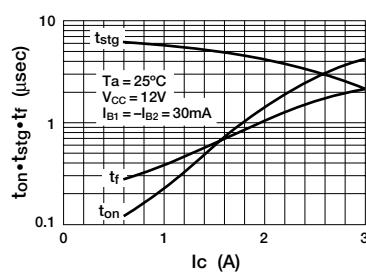

■ θ_{j-c}•θ_{j-a}—t Characteristics (Single pulse)

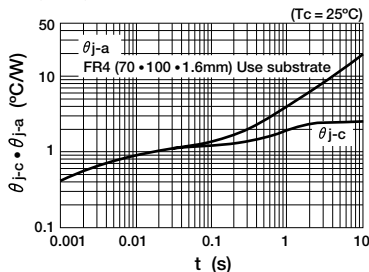

■ Safe Operating Area (Single pulse)

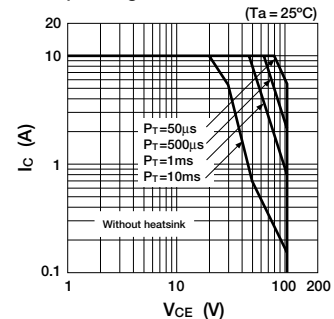

■ P_T—T_a Derating

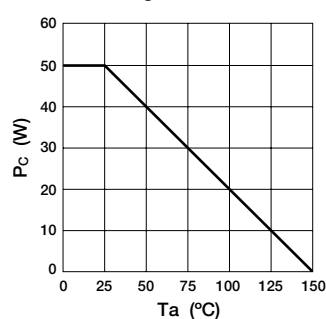

Power Transistor MN638S

Absolute Maximum Ratings (Ta=25°C)

Symbol	Ratings	Unit
V _{CB0}	380±50	V
V _{CE0}	380±50	V
V _{EB0}	6	V
I _c	6 (pulse 10)	A
I _B	1	A
P _c	60 (T _c =25°C)	W
T _j	150	°C
T _{stg}	-55 to +150	°C

Electrical Characteristics (Ta=25°C)

Symbol	Test Conditions	Ratings	Unit
I _{CB0}	V _{CB} =330V	10max	μA
I _{EB0}	V _{EB} =6V	20max	mA
V _{(BR) CEO}	I _c =25mA	330 to 430	V
h _{FE}	V _{CE} =2V, I _c =3A	1500min	
V _{CE (sat)}	I _c =4A, I _B =20mA	1.5max	V

External Dimensions TO220S

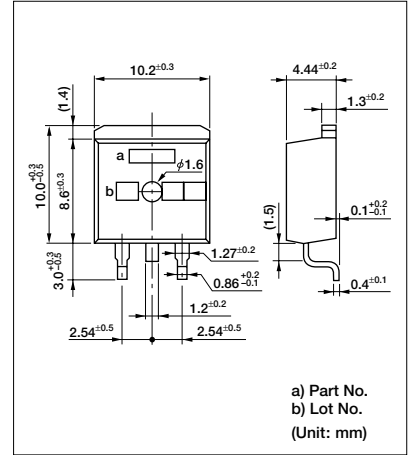

■ I_c—V_{CE} Characteristics (typ.)

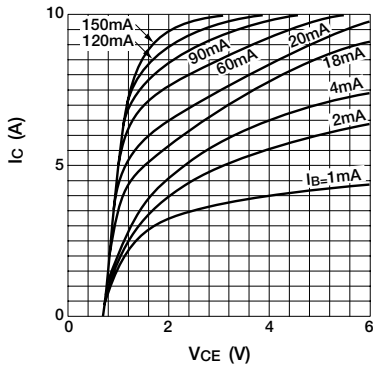

■ V_{CE (sat)}—I_B Characteristics (typ.)

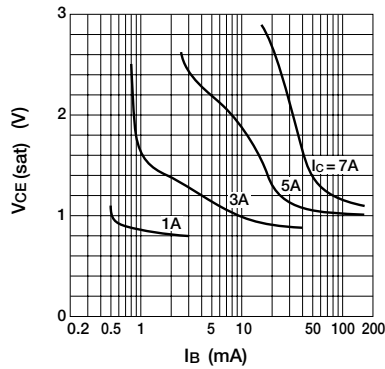

■ I_c—V_{BE} Temperature Characteristics (typ.)

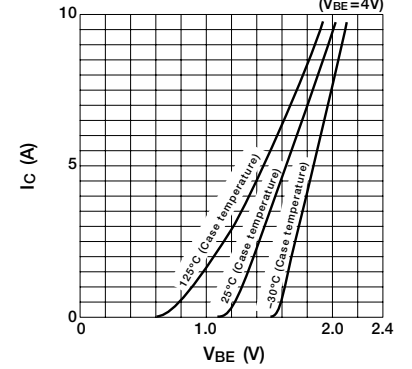

■ h_{FE}—I_c Characteristics (typ.)

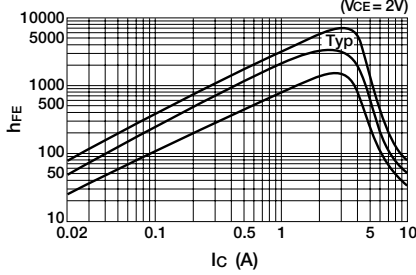

■ h_{FE}—I_c Temperature Characteristics (typ.)

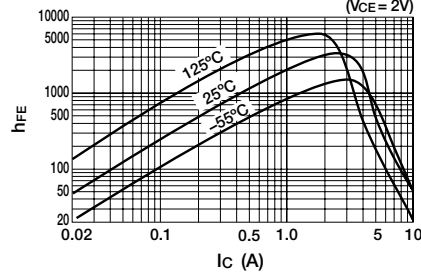

■ θ_{j-c}•θ_{j-a}—t Characteristics

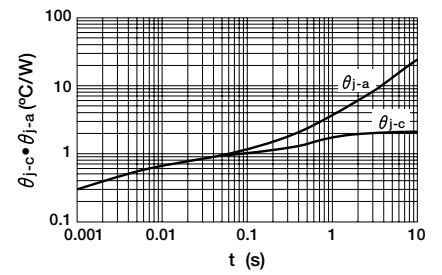

Surface-mount Power Transistor SSD103

Absolute Maximum Ratings (Ta=25°C)

Symbol	Ratings	Unit
Vcbo	65±5	V
Vceo	65±5	V
Vebo	6	V
Ic	6	A
Ic (pulse)	10 (Pw≤1mS, Duty≤25%)	A
Ib	10	A
Pc	1.5*1	W
Tj	150	°C
Tstg	-55 to +150	°C

*1: FR4 70mm×100mm×1.6mm
(drain heatsink copper foil area 25×25mm)

Electrical Characteristics (Ta=25°C)

Symbol	Test Conditions	Ratings			Unit
		min	typ	max	
ICBO	V _{CB} = 60V, I _E = 0A			10	μA
IEBO	V _{EB} = 6V, I _C = 0A			10	μA
VCEO	I _C = 50mA	60	65	70	V
hFE	V _{CE} = 1V, I _C = 1A	400	800	1500	
VCE (sat)	I _C = 1.5A, I _B = 15mA		0.11	0.15	V
VFEC	I _{FEC} = 6A		1.25	1.5	V
Es/b	L = 10mH	80			mJ

External Dimensions SOP8

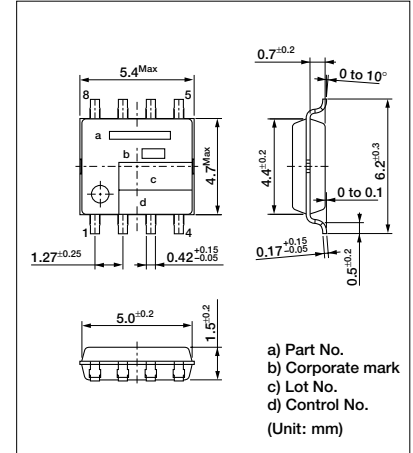

IC—VCE Characteristics (typ.)

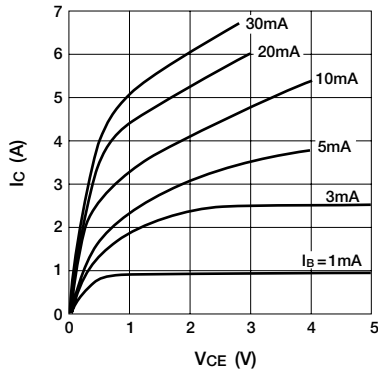

VCE (sat)—IC Temperature Characteristics (typ.)

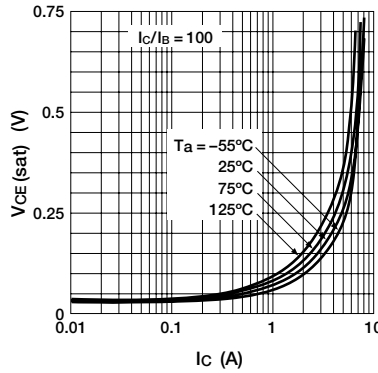

IC—VBE Temperature Characteristics (typ.)

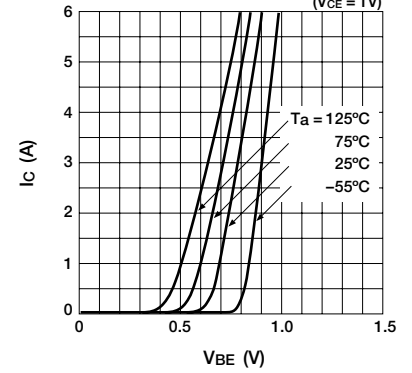

hFE—IC Temperature Characteristics (typ.)

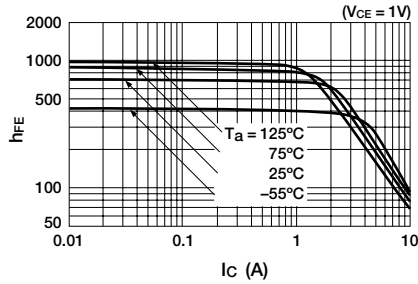

ton • tstg • tr—IC Characteristics (typ.)

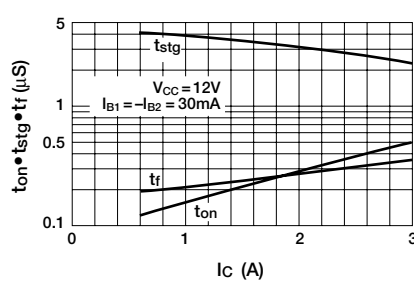

Safe Operating Area (Single pulse)

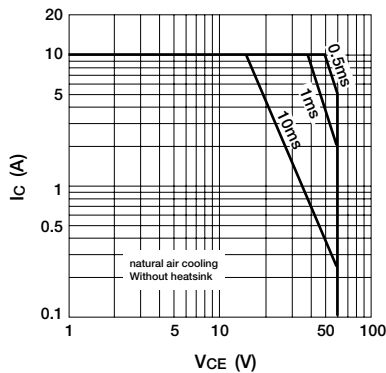

Equivalent Circuit Diagram

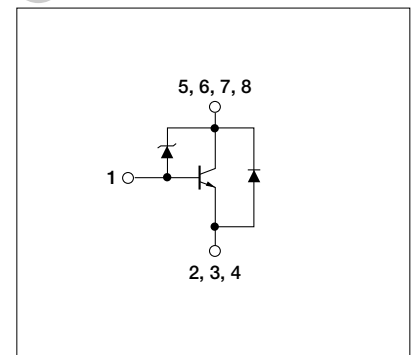

Surface-mount Power Transistor Array SDA03

Absolute Maximum Ratings (Ta=25°C)

Symbol	Ratings	Unit
V _{CB0}	-60	V
V _{CEO}	-60	V
V _{EBO}	-6	V
I _C	-6 (pulse -12)	A
I _B	-1	A
P _T	3 (No Fin)	W
T _J	150	°C
T _{stg}	-55 to +150	°C

Electrical Characteristics (Ta=25°C)

Symbol	Test Conditions	Ratings	Unit
I _{CB0}	V _{CB} = -60V	-10max	μA
I _{EBO}	V _{EB} = -6V	-10max	μA
V _{CEO}	I _C = -25mA	-60min	V
h _{FE}	V _{CE} = -4V, I _C = -2A	100min	
V _{CE(sat)}	I _C = -2A, I _B = -0.1A	-0.4max	V

Typical Switching Characteristics

V _{CC} (V)	R _L (Ω)	I _C (A)	V _{BB1} (V)	V _{BB2} (V)	I _{B1} (mA)	I _{B2} (mA)	t _{on} (μs)	t _{stg} (μs)	t _f (μs)
-12	12	-1	-10	5	-50	50	0.4	1.75	0.22

External Dimensions SMD-16A

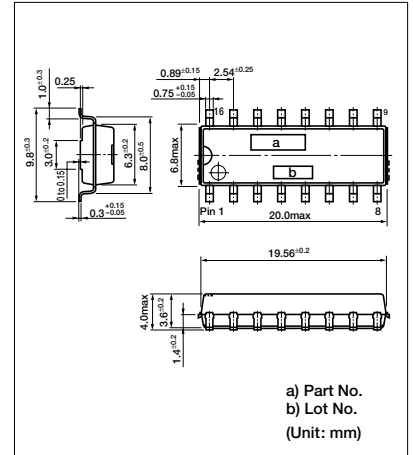

I_C—V_{CE} Characteristics

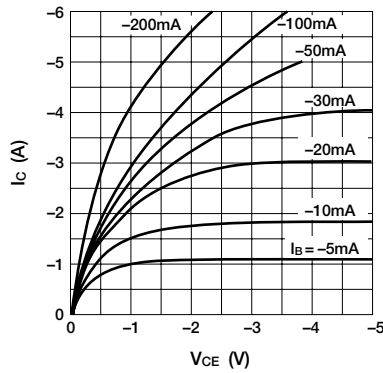

V_{CE(sat)}—I_C Temperature Characteristics (typ.)

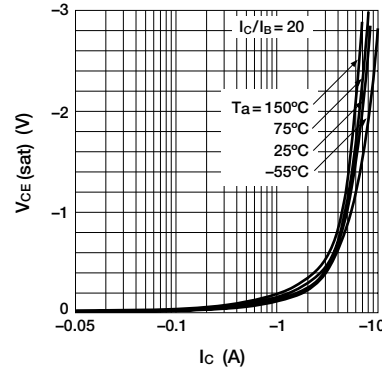

I_C—V_{BE} Temperature Characteristics (typ.)

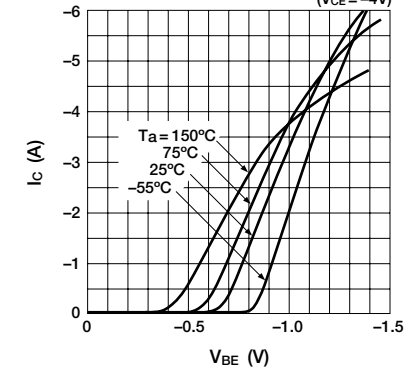

h_{FE}—I_C Temperature Characteristics

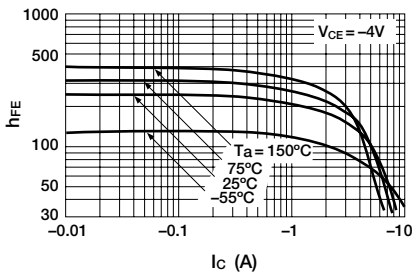

t_{on}•t_{stg}•t_f—I_C Characteristics

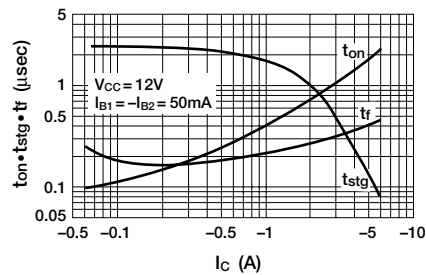

θ_{J-a}—t Characteristics (Single pulse)

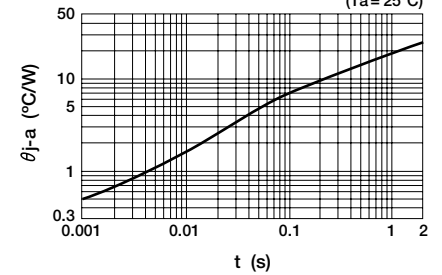

Safe Operating Area (Single pulse)

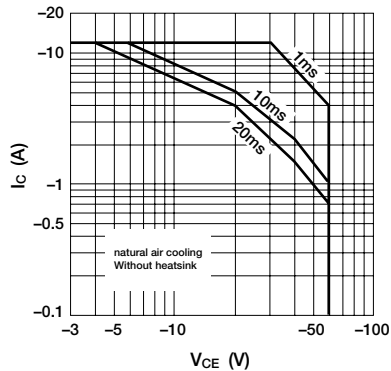

P_T—Ta Derating

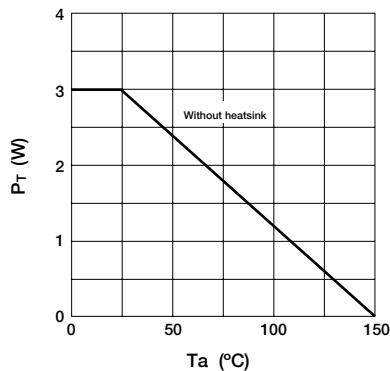

Equivalent Circuit Diagram

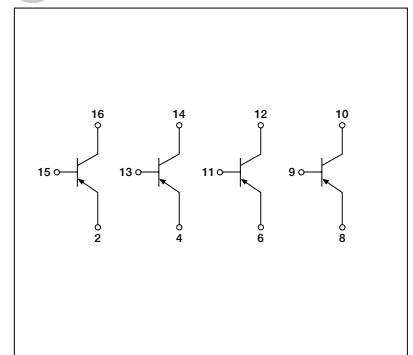

Surface-mount Power Transistor Array SDA04

Absolute Maximum Ratings (Ta=25°C)

Symbol	Ratings	Unit
V _{CB0}	-60	V
V _{CE0}	-60	V
V _{EB0}	-6	V
I _C	-6 (pulse -12)	A
I _B	-1	A
P _T	2.5 (No Fin)	W
T _J	150	°C
T _{stg}	-55 to +150	°C

Electrical Characteristics (Ta=25°C)

Symbol	Test Conditions	Ratings	Unit
I _{CB0}	V _{CB} = -60V	-10max	μA
I _{EB0}	V _{EB} = -6V	-10max	μA
V _{CE0}	I _C = -25mA	-60min	V
h _{FE}	V _{CE} = -4V, I _C = -2A	100min	
V _{CE(sat)}	I _C = -2A, I _B = -0.1A	-0.4max	V

Typical Switching Characteristics

V _{CC} (V)	R _L (Ω)	I _C (A)	V _{BB1} (V)	V _{BB2} (V)	I _{B1} (mA)	I _{B2} (mA)	t _{on} (μs)	t _{stg} (μs)	t _f (μs)
-12	12	-1	-10	5	-50	50	0.4	1.75	0.22

External Dimensions SMD-16A

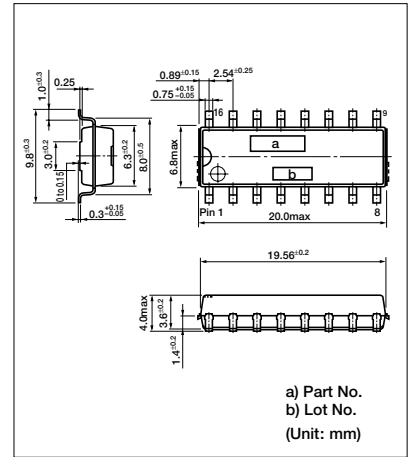

I_C—V_{CE} Characteristics

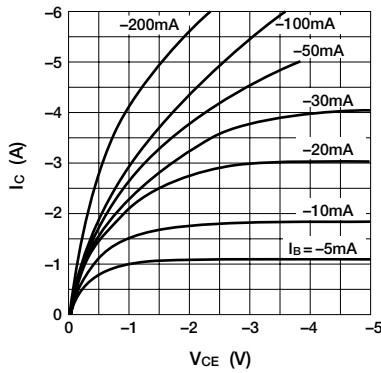

V_{CE(sat)}—I_C Temperature Characteristics (typ.)

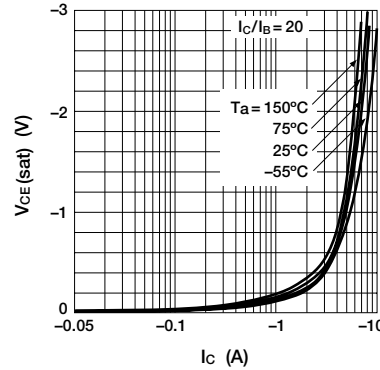

I_C—V_{BE} Temperature Characteristics (typ.)

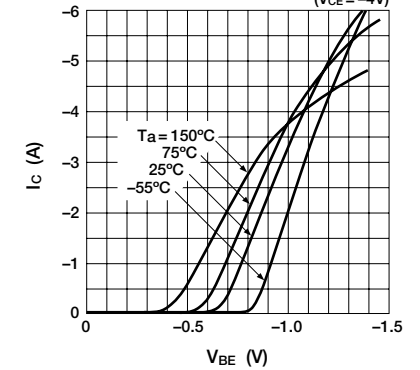

h_{FE}—I_C Temperature Characteristics

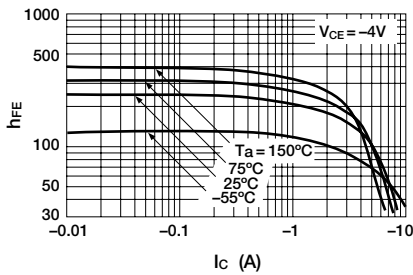

t_{on}•t_{stg}•t_f—I_C Characteristics

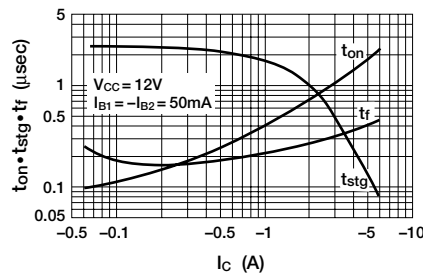

θ_{j-a}—t Characteristics (Single pulse)

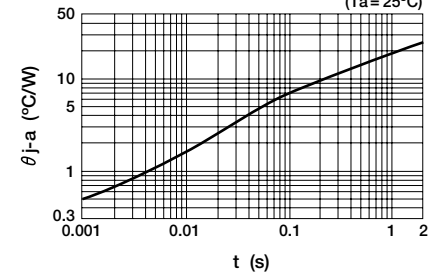

Safe Operating Area (Single pulse)

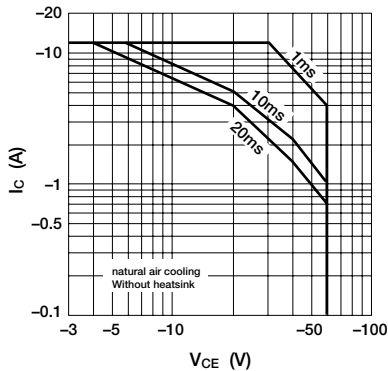

P_T—Ta Derating

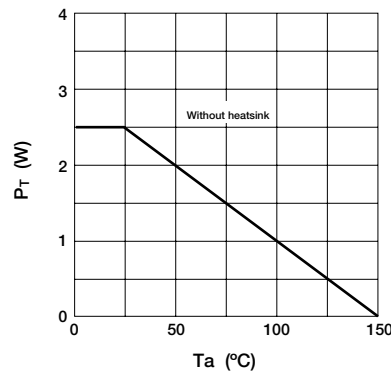

Equivalent Circuit Diagram

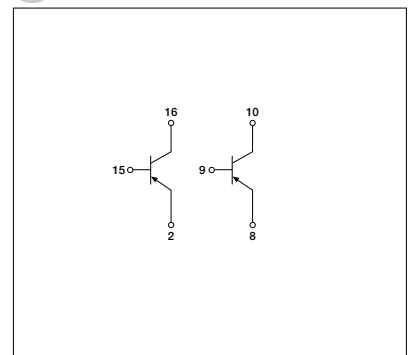

Surface-mount Power Transistor Array SDC09

Absolute Maximum Ratings (Ta=25°C)

Symbol	Ratings	Unit
Vcbo	65±5	V
Vceo	65±5	V
Vebo	6	V
Ic	6 (pulse 10*)	A
Ib	1	A
P _T	2.8	W
T _J	150	°C
Tstg	-55 to +150	°C

* P_w ≤ 100μs, Duty ≤ 1%

Electrical Characteristics (Ta=25°C)

Symbol	Test Conditions	Ratings	Unit
Icbo	V _{CB} = 60V	10max	μA
Iebo	V _{EB} = 6V	10max	μA
Vceo	I _C = 50mA	60 to 70	V
hFE	V _{CE} = 1V, I _C = 1A	400 to 1500	
VCE(sat)	I _C = 1.5A, I _B = 15mA	0.15max	V
VfEC	I _{FEC} = 6A	1.5max	V
Es/b	L = 10mH, single pulse	80min	mJ

External Dimensions SMD-16A

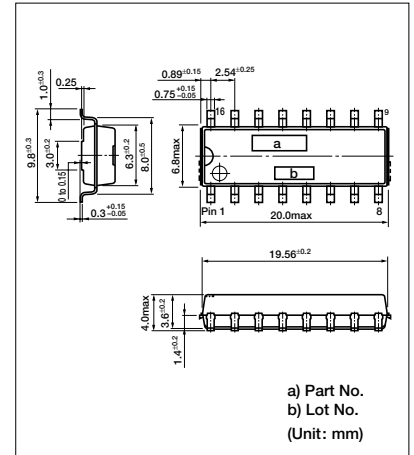

I_C — V_{CE} Characteristics

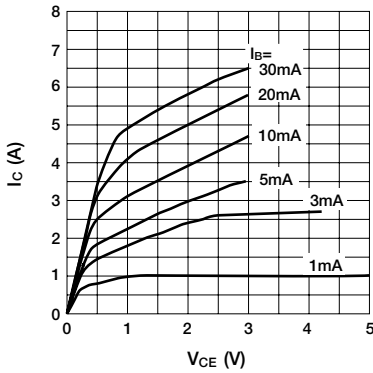

V_{CE}(sat) — I_C Temperature Characteristics (typ.)

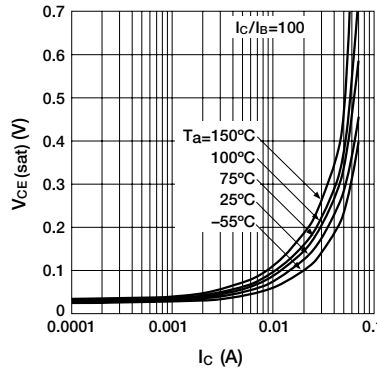

I_C — V_{BE} Temperature Characteristics (typ.)

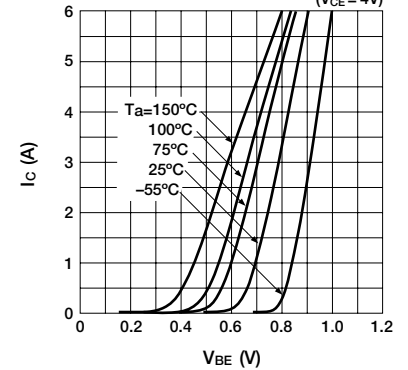

h_{FE} — I_C Temperature Characteristics

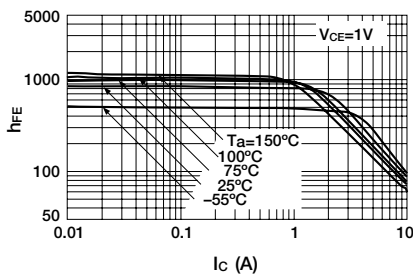

ton • t_{stg} • t_{fr} — I_C Characteristics

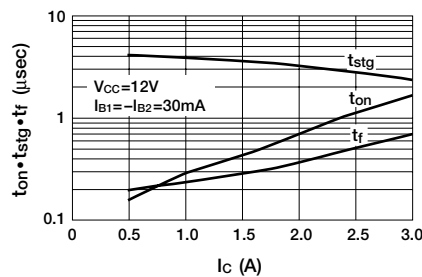

θ_{J-a} — t Characteristics (Single pulse)

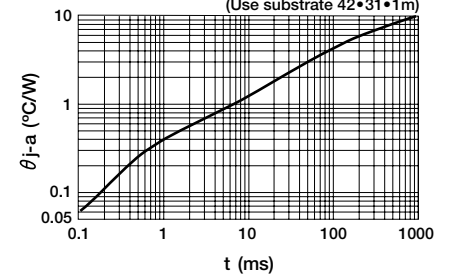

Safe Operating Area (Single pulse)

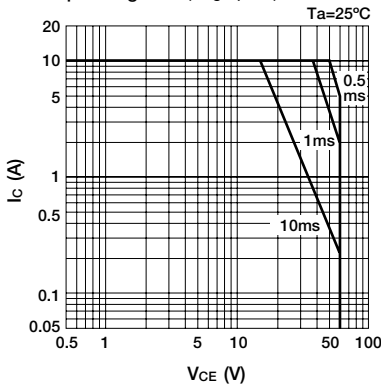

P_T — T_a Derating

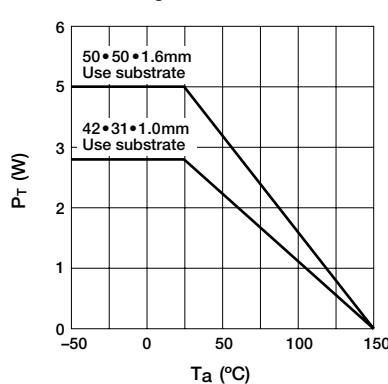

Equivalent Circuit Diagram

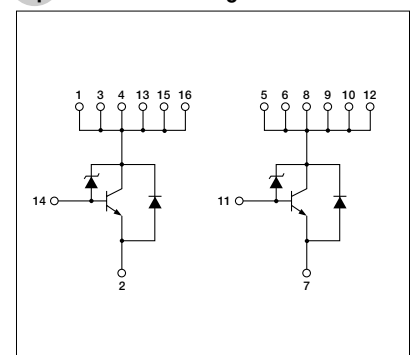

Power Transistor Array SLA8004

Absolute Maximum Ratings (Ta=25°C)

Symbol	Ratings		Unit
	NPN	PNP	
V _{CB0}	60	-55	V
V _{CE0}	60	-55	V
V _{EB0}	6	-6	V
I _C	12	-12	A
I _B	3	-3	A
P _T	5 (Tc=25°C, No Fin)		W
	40 (Tc=25°C)		W
T _J	150		°C
T _{stg}	-55 to +150		°C

Electrical Characteristics (Ta=25°C)

Symbol	NPN		PNP		Unit
	Test Conditions	Ratings	Test Conditions	Ratings	
I _{CB0}	V _{CB} = 60V	100max	V _{CB} = -55V	-100max	μA
I _{EB0}	V _{EB} = 6V	60max	V _{EB} = -6V	-60max	mA
V _{CE0}	I _C = 25mA	60min	I _C = -25mA	-55min	V
h _{FE}	V _{CE} = 1V, I _C = 3A	150min	V _{CE} = -1V, I _C = -3A	80min	
V _{CE(sat)}	I _C = 6A, I _B = 0.3A	0.35max	I _C = -6A, I _B = -0.3A	-0.35max	V
V _{FEC}	I _{FEC} = 10A	2.5max	I _{FEC} = 10A	2.5max	V

External Dimensions SLA 12pin (LF817)

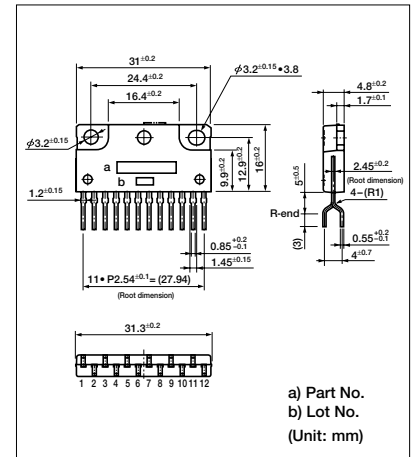

■ I_C—V_{CE} Characteristics (typ.) (PNP)

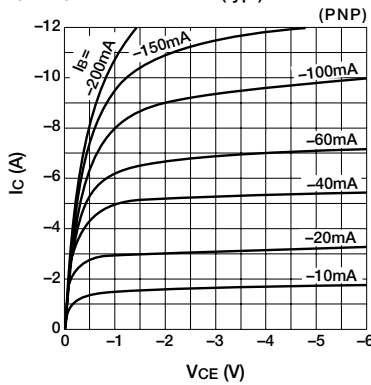

■ I_C—V_{CE} Characteristics (typ.) (NPN)

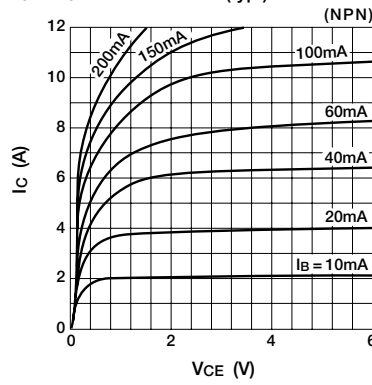

■ h_{FE}—I_C Characteristics (typ.) (PNP)

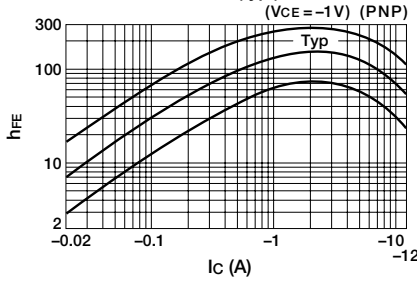

■ h_{FE}—I_C Characteristics (typ.) (NPN)

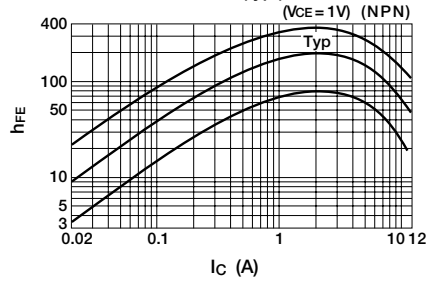

■ h_{FE}—I_C Temperature Characteristics (typ.) (PNP)

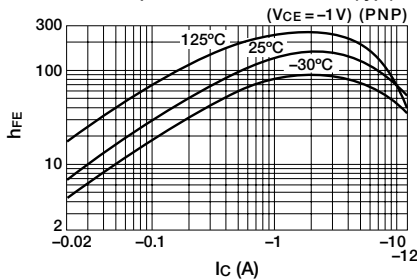

■ h_{FE}—I_C Temperature Characteristics (typ.) (NPN)

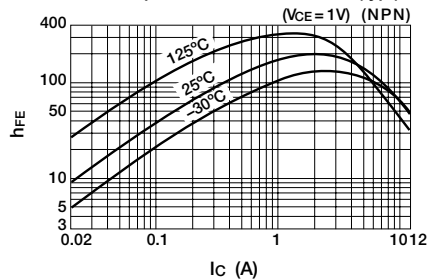

■ V_{CE(sat)}—I_B Characteristics (typ.) (PNP)

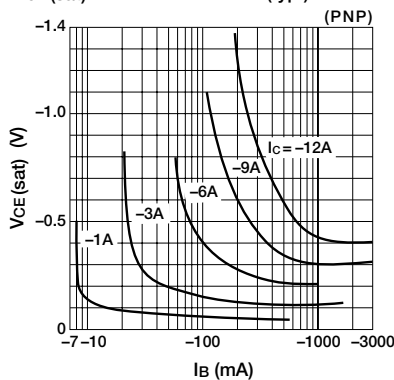

■ V_{CE(sat)}—I_B Characteristics (typ.) (NPN)

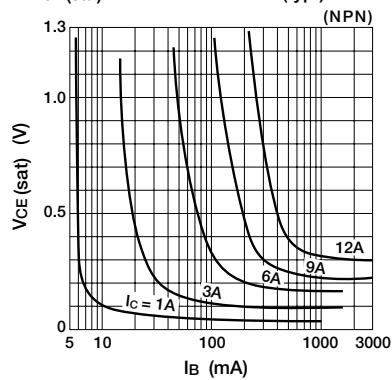

Equivalent Circuit Diagram

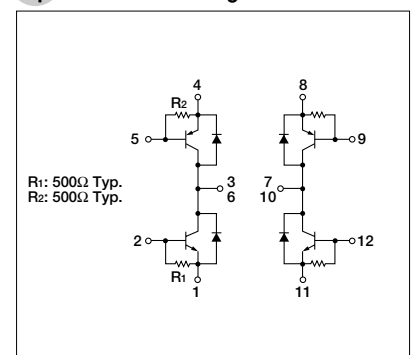

Surface-mount Power Transistor Array SPF0001

Absolute Maximum Ratings (Ta=25°C)

Symbol	Ratings	Unit
V _{CB0}	115±10	V
V _{CEO}	115±10	V
V _{EBO}	6	V
I _C	±6 (pulse ±10)	A
I _B	1	A
P _T *	2.5 (Ta=25°C)	W
T _J	150	°C
T _{stg}	-55 to +150	°C

* Use glass epoxy substrate (FR4) 70mm×100mm×1.6mm

Electrical Characteristics (Ta=25°C)

Symbol	Test Conditions	Ratings			Unit
		min	typ	max	
I _{CB0}	V _{CB} =105V			10	μA
I _{EBO}	V _{EB} =6V			10	μA
V _{CEO}	I _C =50mA	105	115	125	V
h _{FE}	V _{CE} =1V, I _C =1A	400	800	1500	
V _{CE(sat)}	I _C =1.2A, I _B =12mA		0.08	0.12	V
V _{FEC}	I _{FEC} =6A		1.25	1.5	V
Es/b	L=10mH	45			mJ

External Dimensions SPF 20pin

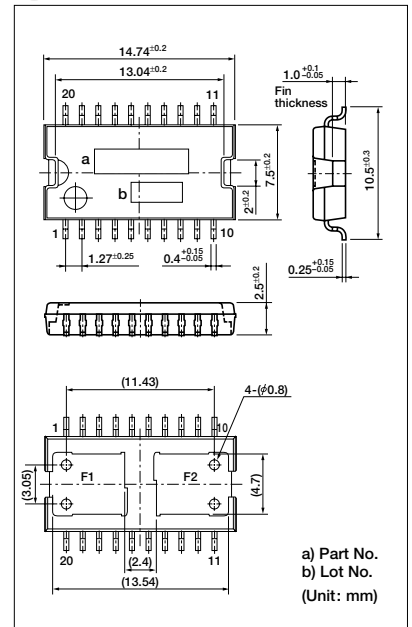

■ h_{FE}—I_C Temperature Characteristics (typ.)

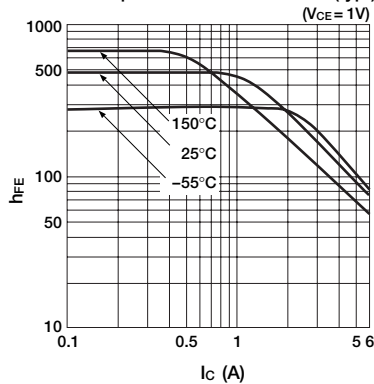

■ V_{CE(sat)}—I_B Temperature Characteristics (typ.)

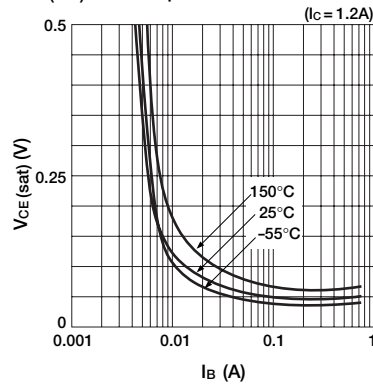

■ I_C—V_{EC} Temperature Characteristics (typ.)

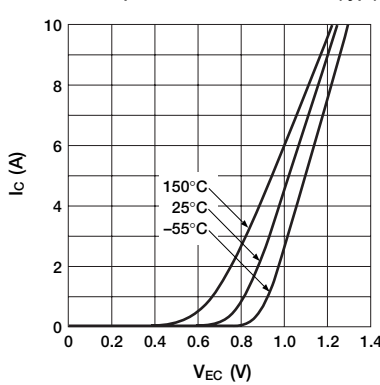

■ I_C—V_{BE} Temperature Characteristics (typ.)

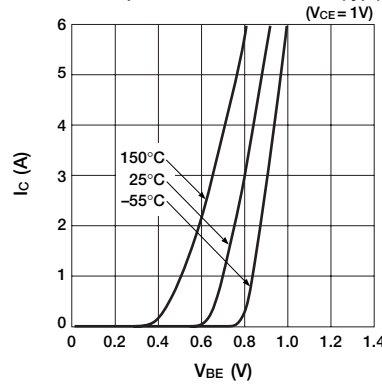

■ Safe Operating Area (single pulse)

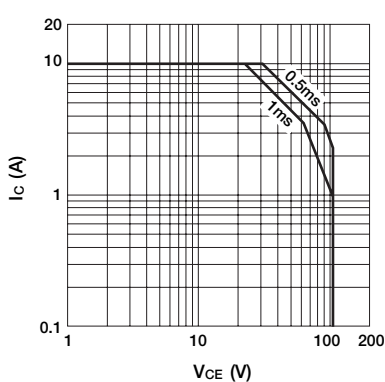

■ Transient thermal resistance characteristics (82×36×1mm at the time of mounting the recommended pattern of the glass epoxy board)

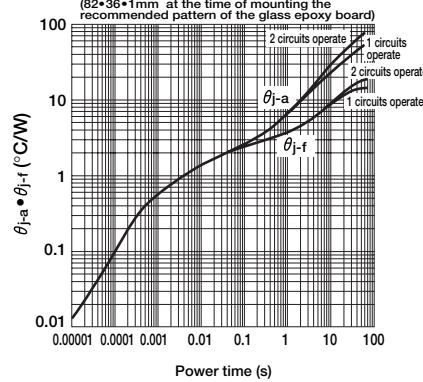

Equivalent Circuit Diagram

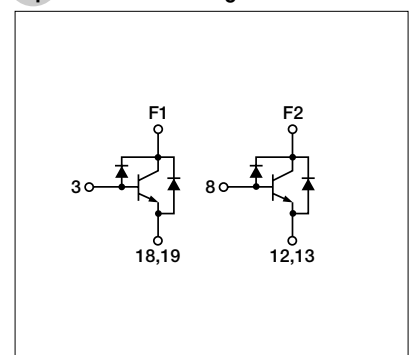

Power Transistor Array STA315A

Absolute Maximum Ratings (Ta=25°C)

Symbol	Rated Values	Unit
V _{CB0}	35±5	V
V _{CE0}	36±5	V
V _{EB0}	6	V
I _C	2 (pulse 3*)	A
I _B	30	mA
P _T	3 (Ta=25°C) 13.5 (Tc=25°C)	W
T _J	150	°C
T _{stg}	-55 to +150	°C

* P_W ≤ 1ms, Duty ≤ 25%

Electrical Characteristics (Ta=25°C)

Symbol	Test Conditions	Rated Values	Unit
I _{CB0}	V _{CB} = 30V	10max	μA
I _{EB0}	V _{EB} = 6V	2.7max	mA
V _{CE0}	I _C = 25mA	31 to 41	V
h _{FE}	V _{CE} = 4V, I _C = 0.7A	400min	
V _{CE (sat)}	I _C = 0.5A, I _B = 5mA	0.2max	V
	I _C = 1A, I _B = 5mA	0.5max	V
V _{FEC}	I _{FEC} = 2A	2.5max	V
R _B		800±120	Ω
R _{BE}		2.0±0.4	kΩ
Es/b	L = 10mH, single pulse	50min	mJ

Typical Switching Characteristics

V _{CC} (V)	R _L (Ω)	I _C (A)	V _{BB1} (V)	V _{BB2} (V)	I _{B1} (mA)	I _{B2} (mA)	t _{on} (μs)	t _{stg} (μs)	t _f (μs)
12	12	1	10	-5	5	0	1.0	8.5	2.5

External Dimensions STA3 (LF400A)

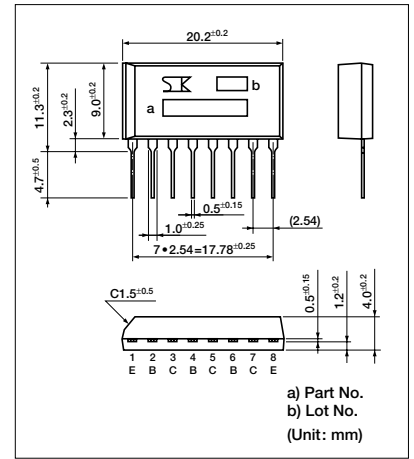

I_C — V_{CE} Characteristics (typ.)

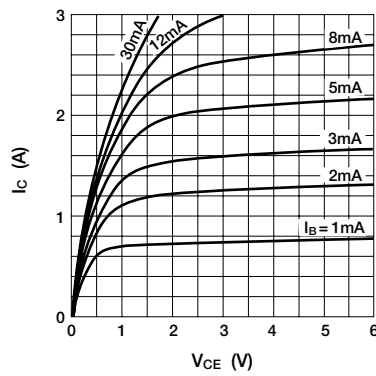

V_{CE (sat)} — I_B Temperature Characteristics

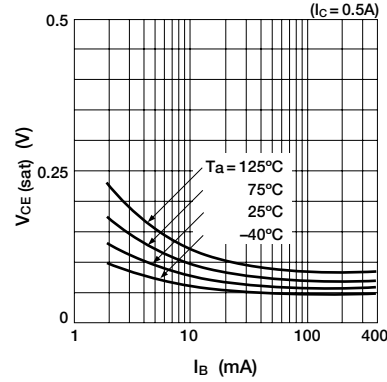

V_{CE (sat)} — I_C Temperature Characteristics

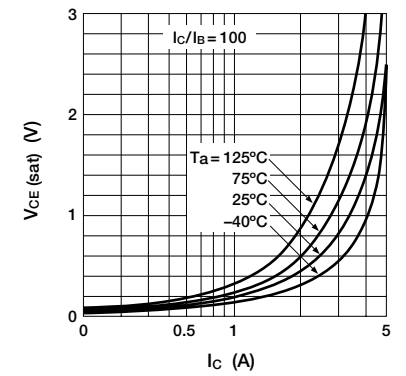

h_{FE} — I_C Temperature Characteristics

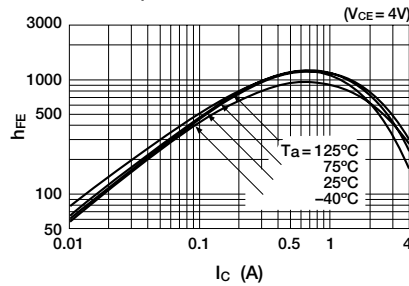

t_{on} • t_{stg} • t_f — I_C Characteristics (typ.)

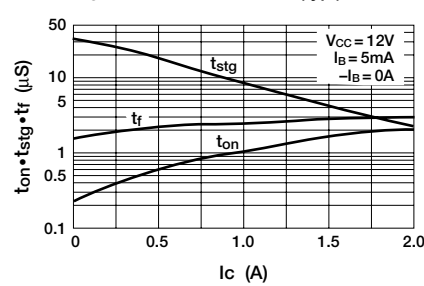

θ_{J-a} — t Characteristics

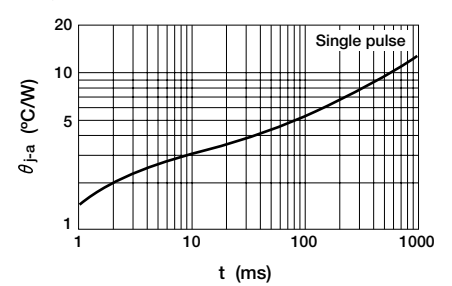

Safe Operating Area (single pulse)

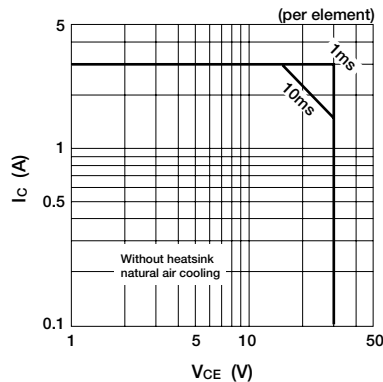

P_T — T_a Derating

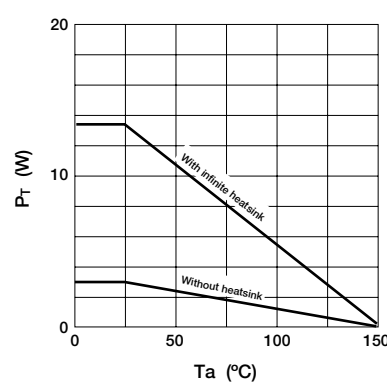

Equivalent Circuit Diagram

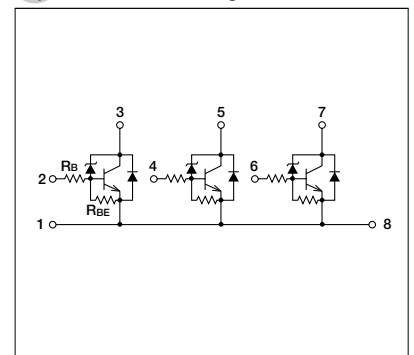

Power Transistor Array STA335A

Absolute Maximum Ratings (Ta=25°C)

Symbol	Ratings	Unit
V _{CB0}	35±5	V
V _{CE0}	35±5	V
V _{EBO}	6	V
I _C	3	A
I _B	1	A
P _T	2.5 (Ta=25°C) 12 (Tc=25°C)	W
T _J	150	°C
T _{stg}	-55 to +150	°C

Electrical Characteristics (Ta=25°C)

Symbol	Test Conditions	Ratings	Unit
I _{CB0}	V _{CB} = 30V	10max	μA
I _{EBO}	V _{EB} = 6V	10max	μA
V _{CE0}	I _C = 25mA	35±5	V
h _{FE}	V _{CE} = 4V, I _C = 0.5A	500min	
V _{CE(sat)}	I _C = 1A, I _B = 5mA	0.5max	V
Es/b	L = 10mH, single pulse	150min	mJ

Typical Switching Characteristics

V _{CC} (V)	R _L (Ω)	I _C (A)	V _{BB1} (V)	V _{BB2} (V)	I _{B1} (mA)	I _{B2} (mA)	t _{on} (μs)	t _{stg} (μs)	t _f (μs)
12	12	1	10	-5	5	5	1.3	4.7	1.2

External Dimensions STA3 (LF400A)

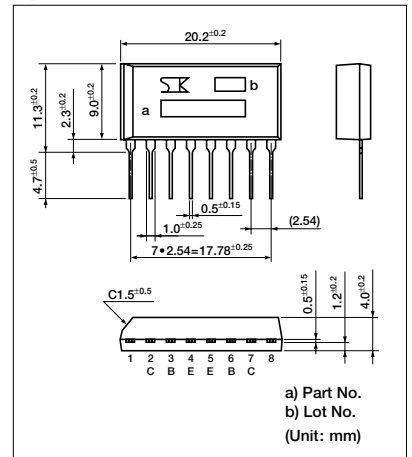

I_C—V_{CE} Characteristics (typ.)

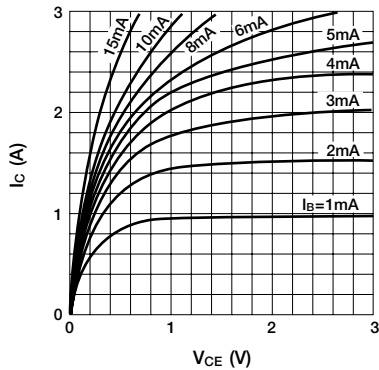

V_{CE(sat)}—I_B Temperature Characteristics

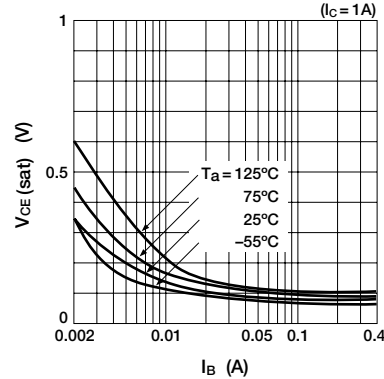

I_C—V_{BE} Temperature Characteristics (typ.)

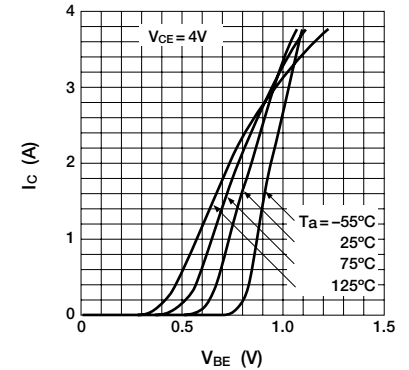

h_{FE}—I_C Temperature Characteristics (typ.)

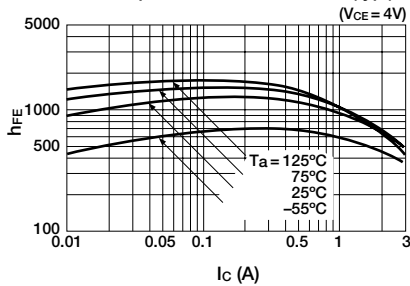

t_{on}·t_{stg}·t_f—I_C Characteristics (typ.)

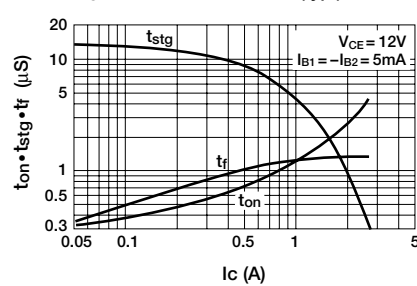

θ_{J-a}—t Characteristics

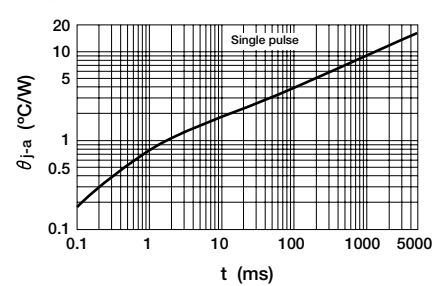

Safe Operating Area (single pulse)

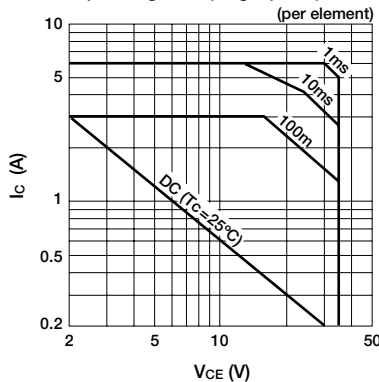

P_T—T_a Derating

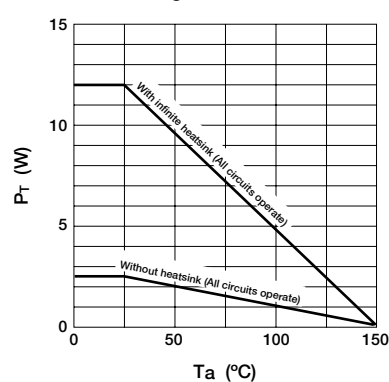

Equivalent Circuit Diagram

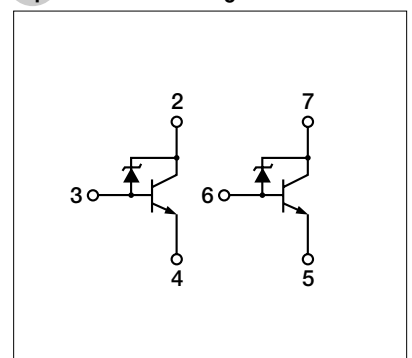

Power Transistor Array STA415A

Absolute Maximum Ratings (Ta=25°C)

Symbol	Ratings	Unit
V _{CB0}	35±5	V
V _{CE0}	36±5	V
V _{EB0}	6	V
I _C	2 (pulse 3*)	A
I _B	30	mA
P _T	4 (Ta = 25°C) 18 (Tc = 25°C)	W
T _J	150	°C
T _{stg}	-55 to +150	°C

* P_w ≤ 1ms, Duty ≤ 25%

Electrical Characteristics (Ta=25°C)

Symbol	Test Conditions	Ratings	Unit
I _{CBO}	V _{CB} = 30V	10max	μA
I _{EB0}	V _{EB} = 6V	2.7max	mA
V _{CE0}	I _C = 25mA	31 to 41	V
h _{FE}	V _{CE} = 4V, I _C = 0.7A	400min	
V _{CE(sat)}	I _C = 0.5A, I _B = 5mA	0.2max	V
	I _C = 1A, I _B = 5mA	0.5max	V
V _{FEC}	I _{FEC} = 2A	2.5max	V
R _B		800±120	Ω
R _{BE}		2.0±0.4	kΩ
Es/b	L = 10mH, single pulse	50min	mJ

Typical Switching Characteristics

V _{CC} (V)	R _L (Ω)	I _C (A)	V _{BB1} (V)	V _{BB2} (V)	I _{B1} (mA)	I _{B2} (mA)	t _{on} (μs)	t _{stg} (μs)	t _f (μs)
12	12	1	10	-5	5	0	1.0	8.5	2.5

External Dimensions STA4 (LF412)

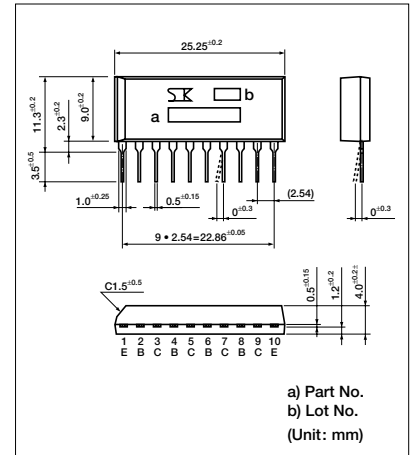

I_C—V_{CE} Characteristics (typ.)

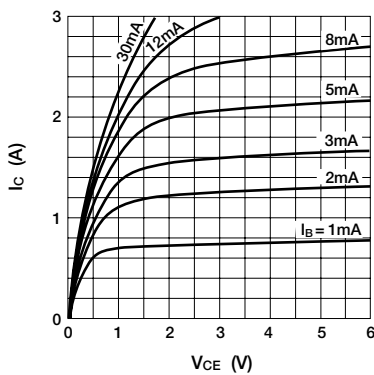

V_{CE(sat)}—I_B Temperature Characteristics

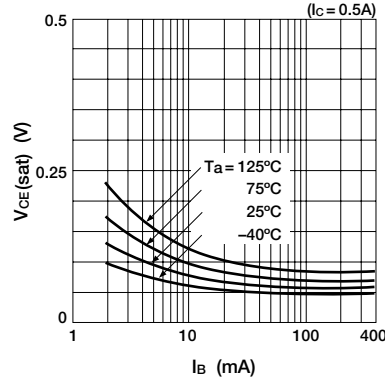

V_{CE(sat)}—I_C Temperature Characteristics

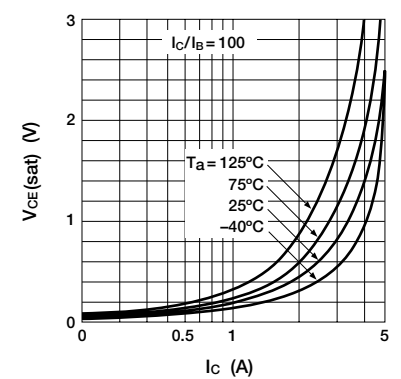

h_{FE}—I_C Temperature Characteristics

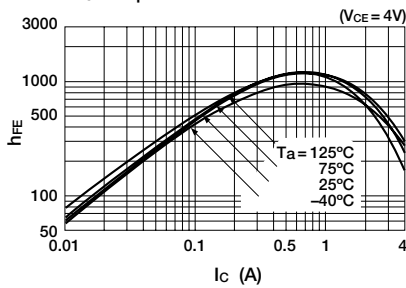

t_{on}·t_{stg}·t_f—I_C Characteristics (typ.)

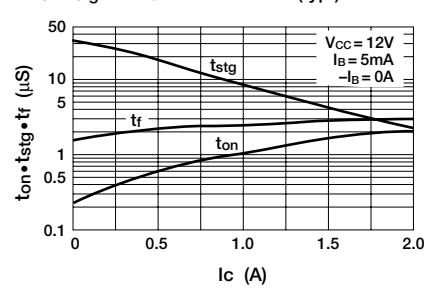

θ_{J-a}—t Characteristics

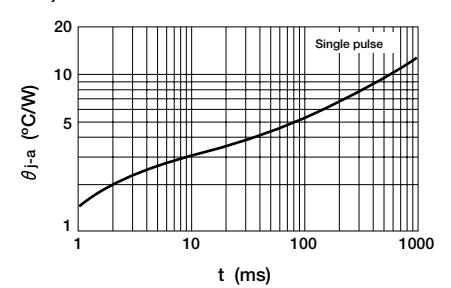

Safe Operating Area (single pulse)

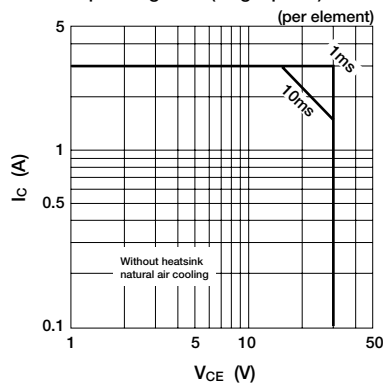

P_T—T_a Derating

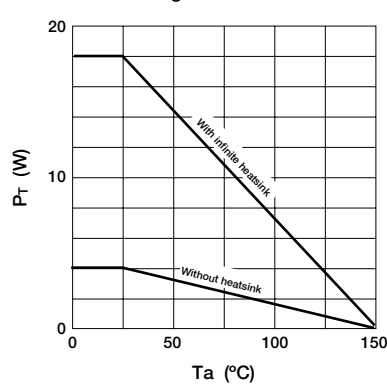

Equivalent Circuit Diagram

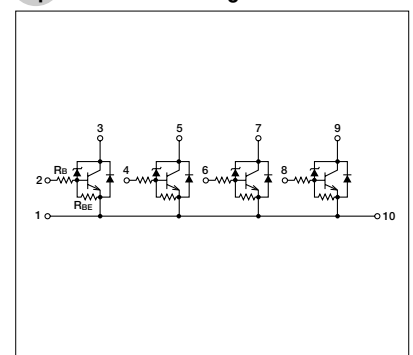

Power Transistor Array STA460C

Absolute Maximum Ratings (Ta=25°C)

Symbol	Rated	Unit
V _{CB0}	60±10	V
V _{CE0}	60±10	V
V _{EB0}	6	V
I _c	±6	A
I _{cP}	±10 (P _W ≤ 1ms, D _u ≤ 50%)	A
P _T	3.2 (Ta = 25°C) 18 (Tc = 25°C)	W
T _j	150	°C
T _{stg}	-40 to +15	°C

Electrical Characteristics (Ta=25°C)

Symbol	Test Conditions	Rated			Unit
		min	typ	max	
I _{CB0}	V _{CB} = 50V			10	μA
I _{EB0}	V _{EB} = 6V			10	μA
V _{CE0}	I _c = 50mA	50	60	70	V
h _{FE}	V _{CE} = 1V, I _c = 1A	700	1500	3000	
V _{CE(sat)}	I _c = 1.5A, I _B = 15mA	0.09	0.15		V
V _{FEC}	I _{FEC} = 6A		1.25	1.5	V
Es/b	L = 10mH, single pulse	200			mJ

External Dimensions STA4 (LF412)

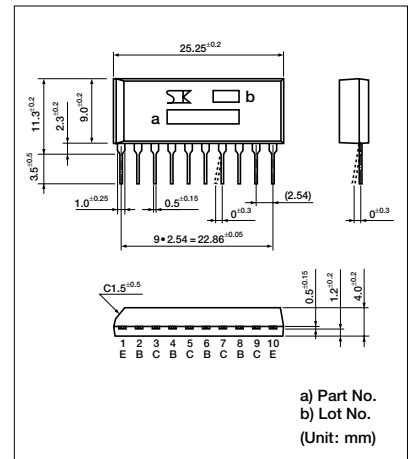

I_c—V_{CE} Characteristics (typ.)

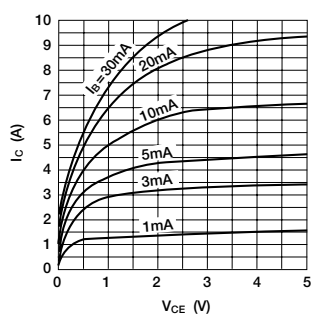

h_{FE}—I_c Characteristics (typ.)

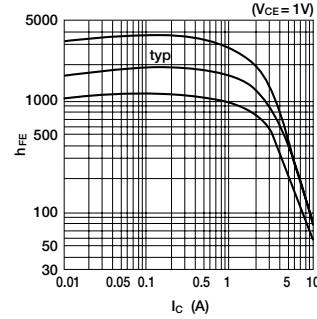

h_{FE}—I_c Temperature Characteristics (typ.)

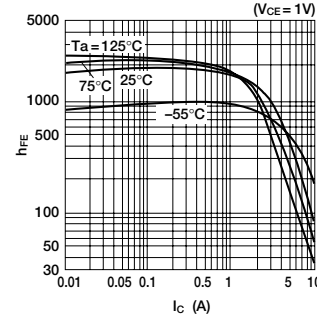

V_{CE(sat)}—I_c Temperature Characteristics (typ.)

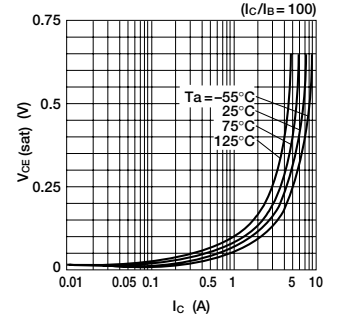

V_{CE(sat)}—I_B Temperature Characteristics (typ.)

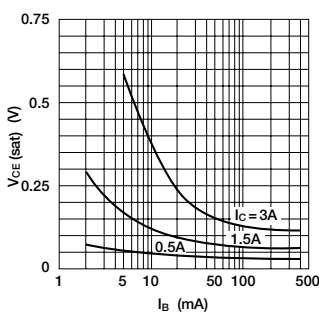

I_c—V_{BE} Temperature Characteristics (typ.)

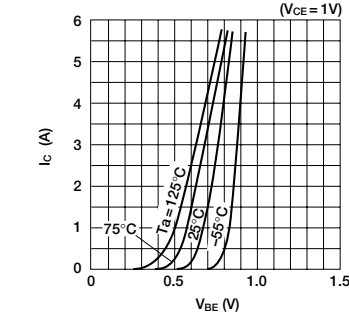

θ_{j-a}—PW Characteristics

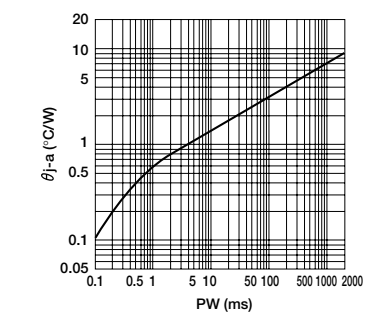

P_T—T_a Derating

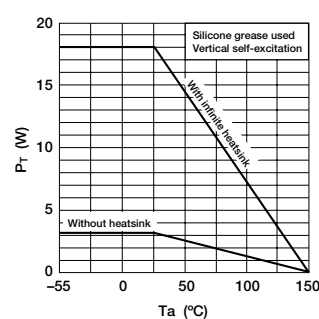

Safe Operating Area

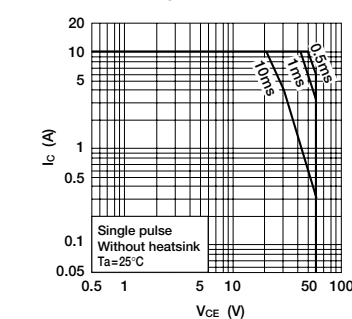

Equivalent Circuit Diagram

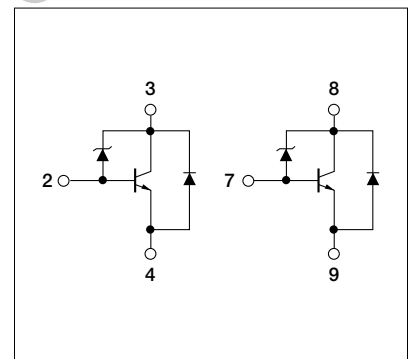

Power Transistor Array STA461C

Absolute Maximum Ratings (Ta=25°C)

Symbol	Rated	Unit
V _{CB0}	65±5	V
V _{CE0}	65±5	V
V _{EB0}	6	V
I _C	±6 (pulse ±10)	A
I _B	1	A
P _T	3.2 (Ta = 25°C) 18 (Tc = 25°C)	W
T _J	150	°C
T _{stg}	-55 to +150	°C

Electrical Characteristics (Ta=25°C)

Symbol	Test Conditions	Rated	Unit
I _{CB0}	V _{CB} = 60V	10max	μA
I _{EB0}	V _{EB} = 6V	10max	μA
V _{CE0}	I _C = 50mA	60 to 70	V
h _{FE}	V _{CE} = 1V, I _C = 1A	400 to 1500	
V _{CE(sat)}	I _C = 1.5A, I _B = 15mA	0.15max	V
V _{FEC}	I _{FEC} = 6A	1.5max	V
Es/b	L = 10mH, single pulse	80min	mJ

Typical Switching Characteristics

V _{CC} (V)	R _L (Ω)	I _C (A)	V _{BB1} (V)	V _{BB2} (V)	I _{B1} (mA)	I _{B2} (mA)	t _{on} (μs)	t _{stg} (μs)	t _f (μs)
12	12	1	10	-5	30	-30	0.2	3.9	0.2

External Dimensions STA4 (LF400B)

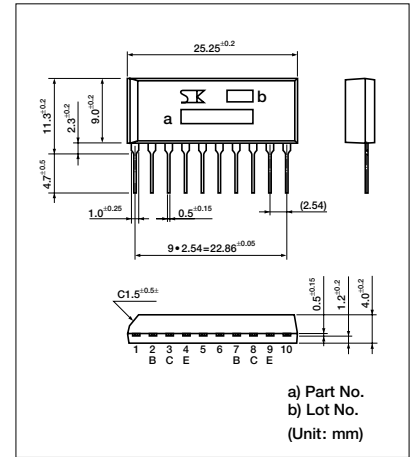

■ I_C—V_{CE} Characteristics (typ.)

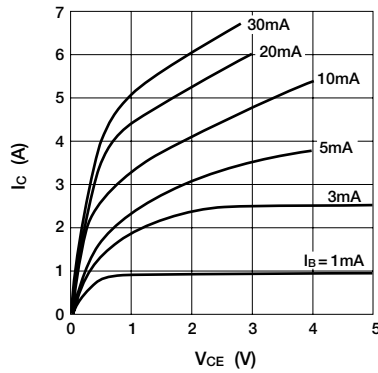

■ V_{CE(sat)}—I_C Temperature Characteristics (typ.)

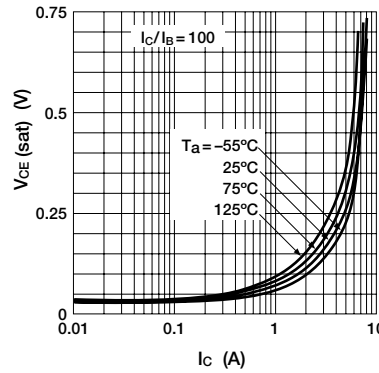

■ I_C—V_{BE} Temperature Characteristics (typ.)

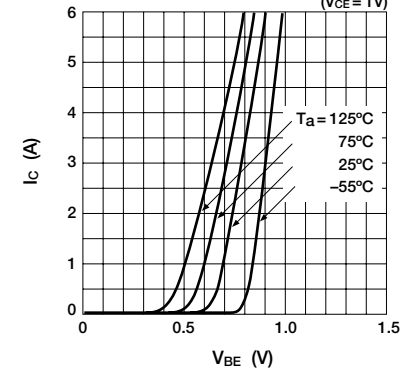

■ h_{FE}—I_C Temperature Characteristics (typ.)

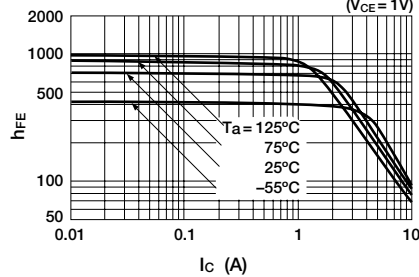

■ t_{on}·t_{stg}·t_f—I_C Characteristics

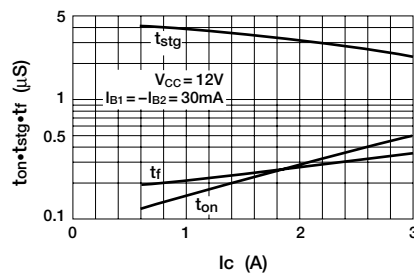

■ θ_{J-a}—t Characteristics

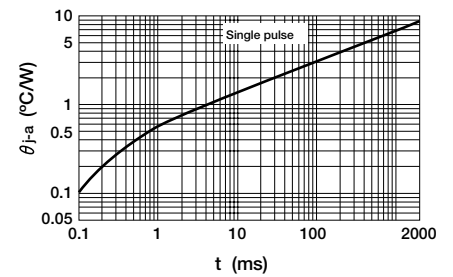

■ Safe Operating Area (single pulse)

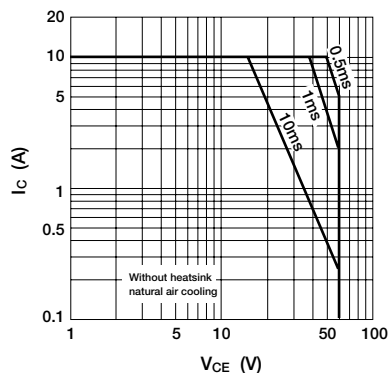

■ P_T—Ta Derating

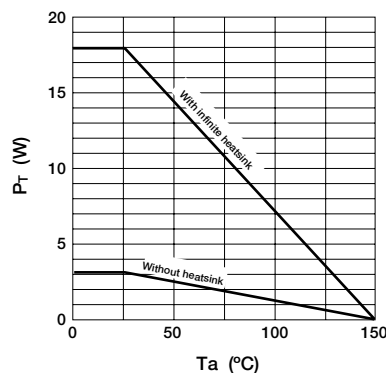

Equivalent Circuit Diagram

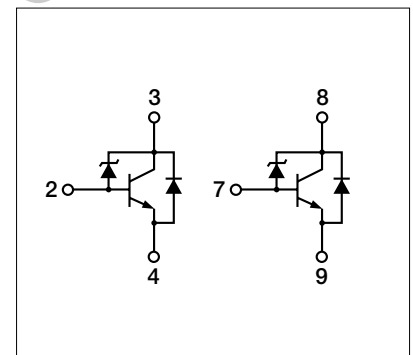

Power Transistor Array STA463C

Absolute Maximum Ratings (Ta=25°C)

Symbol	Ratings	Unit
V _{CB0}	115±10	V
V _{CE0}	115±10	V
V _{EBO}	6	V
I _C	±6 (pulse ±10)	A
I _B	1	A
P _T	3.2 (Ta=250°C) 18 (Tc=25°C)	W
T _J	150	°C
T _{stg}	-55 to +150	°C

Electrical Characteristics (Ta=25°C)

Symbol	Test Conditions	Ratings	Unit
I _{CB0}	V _{CB} = 105V	10max	μA
I _{EBO}	V _{EB} = 6V	10max	μA
V _{CE0}	I _C = 50mA	105 to 125	V
h _{FE}	V _{CE} = 1V, I _C = 1A	400 to 1500	
V _{CE(sat)}	I _C = 1.2A, I _B = 12mA	0.12max	V
V _{FEC}	I _{FEC} = 6A	1.5max	V
Es/b	L = 10mH, single pulse	45min	mJ

Typical Switching Characteristics

V _{CC} (V)	R _L (Ω)	I _C (A)	V _{BB1} (V)	V _{BB2} (V)	I _{B1} (mA)	I _{B2} (mA)	t _{on} (μs)	t _{stg} (μs)	t _f (μs)
12	12	1	10	-5	30	-30	0.2	5.7	0.4

External Dimensions STA4 (LF400B)

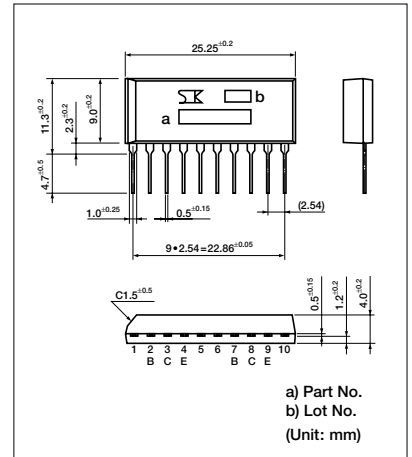

I_C—V_{CE} Characteristics (typ.)

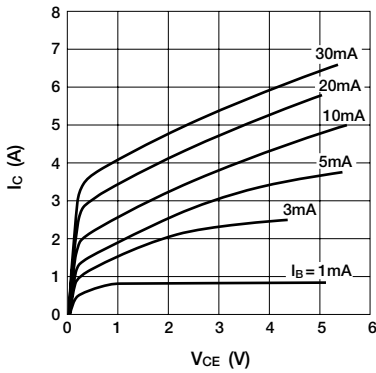

V_{CE(sat)}—I_C Temperature Characteristics (typ.)

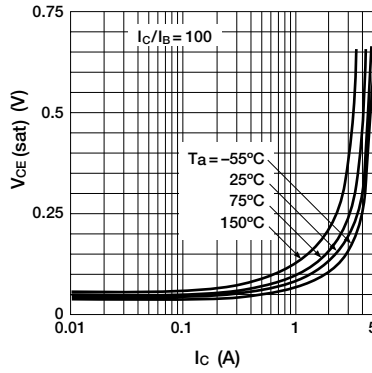

I_C—V_{BE} Temperature Characteristics (typ.)

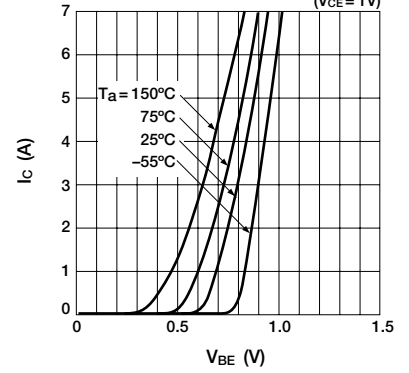

h_{FE}—I_C Temperature Characteristics (typ.)

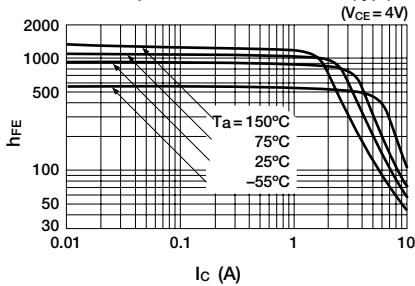

t_{on}·t_{stg}·t_f—I_C Characteristics

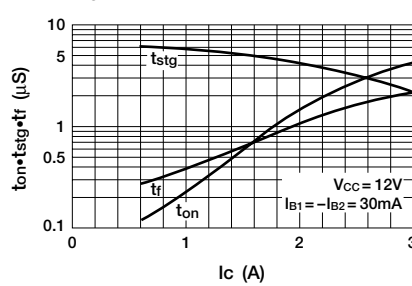

θ_{J-a}—t Characteristics

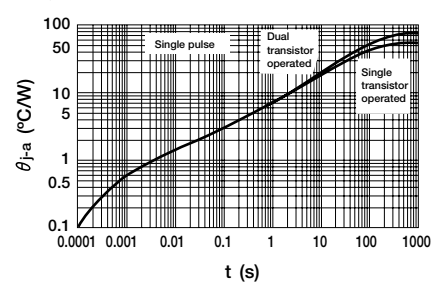

V_{CE(sat)}—I_B Temperature Characteristics (typ.)

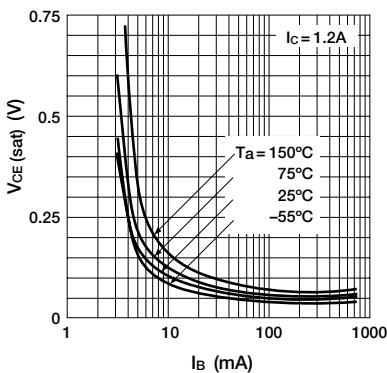

P_T—T_a Derating

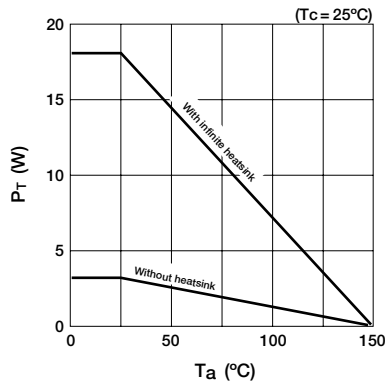

Equivalent Circuit Diagram

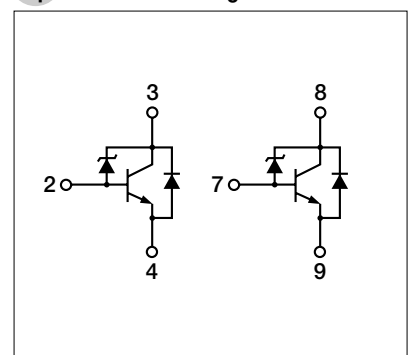

Power Transistor Array STA464C

Absolute Maximum Ratings (Ta=25°C)

Symbol	Rated Values	Unit
V _{CB0}	65±5	V
V _{CE0}	65±5	V
V _{EB0}	6	V
I _C	6 (pulse 10)	A
I _B	1	A
P _C	20 (T _C =25°C) 4 (T _a =25°C)	W
T _J	150	°C
T _{stg}	-55 to +150	°C

Electrical Characteristics (Ta=25°C)

Symbol	Test Conditions	Ratings			Unit
		min	typ	max	
I _{CB0}	V _{CB} =60V			10	μA
I _{EB0}	V _{EB} =6V			10	μA
V _{CE0}	I _C =50mA	60	65	70	V
h _{FE}	V _{CE} =1V, I _C =1A	400	800	1500	
V _{CE(sat)}	I _C =1.5A, I _B =15mA		0.09	0.15	V
V _{FEC}	I _{FEC} =6A		1.25	1.5	V
Es/b	L=10mH	80			mJ

External Dimensions STA4

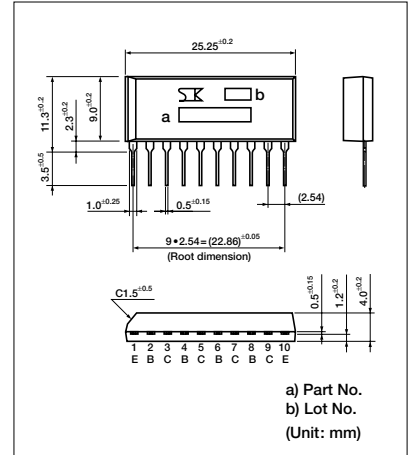

I_C—V_{CE} Characteristics (typ.)

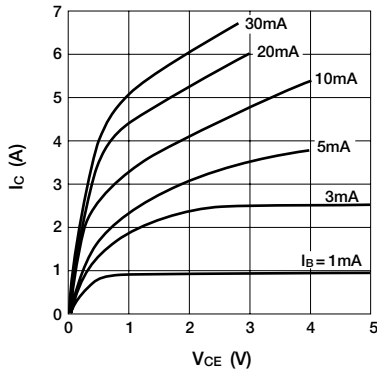

V_{CE(sat)}—I_C Temperature Characteristics (typ.)

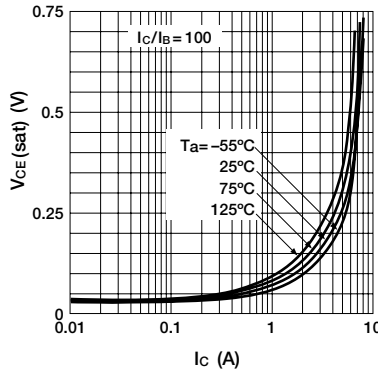

I_C—V_{BE} Temperature Characteristics (typ.)

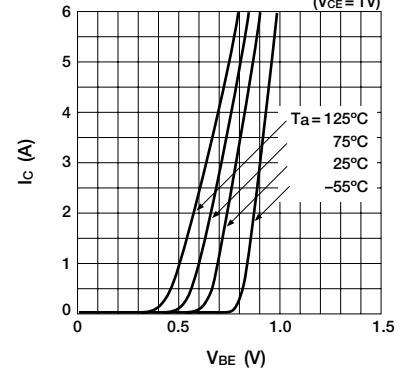

h_{FE}—I_C Temperature Characteristics (typ.)

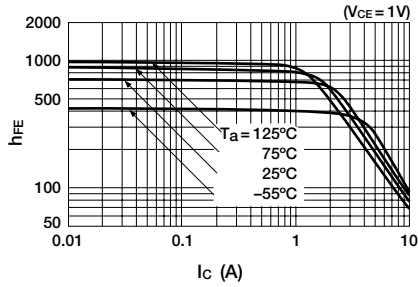

t_{on}·t_{stg}·t_{fr}—I_C Characteristics

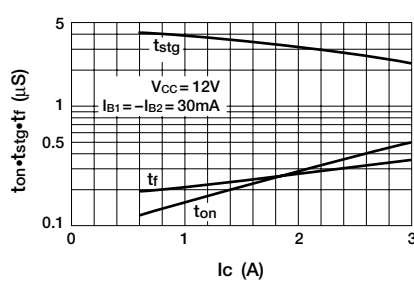

Safe Operating Area (single pulse)

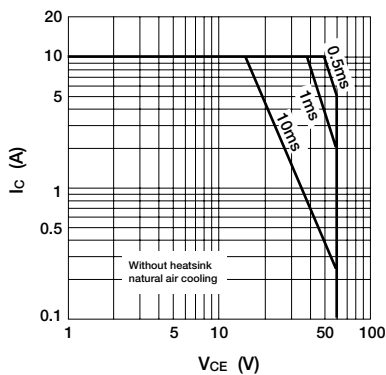

P_T—T_a Derating

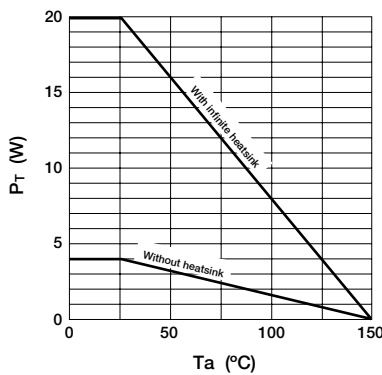

Equivalent Circuit Diagram

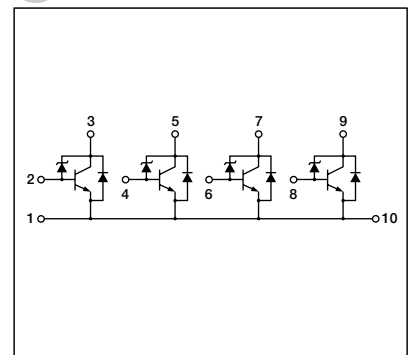

MOS FET 2SK3710 (under development)

Features

- ON resistance 0.0060Ω max.
- Built-in G-S bidirectional Zener diode
- Trench MOS structure

Applications

- Power steering motor
- Various motors
- Replaces mechanical relays

Absolute Maximum Ratings (Ta=25°C)

Symbol	Ratings	Unit
V _{DSS}	60	V
V _{GSS}	20	V
I _D	70	A
I _{D (pulse)}	140	A
P _D	130	W
EAS	400	mJ
T _{ch}	150	°C
T _{stg}	-55 to +150	°C

Electrical Characteristics (Ta=25°C)

Symbol	Test Conditions	Ratings			Unit
		min	typ	max	
V _{(BR) DSS}	I _D = 100μA	60			V
I _{GSS}	V _{GS} = ±20V			±10	μA
I _{DSS}	V _{DS} = 60V, V _{GS} = 0V			100	μA
V _{TH}	V _{DS} = 10V, I _D = 250μA	2		4	V
R _{DS (ON)}	V _{GS} = 10V, I _D = 35A		5.0	6.0	mΩ
V _{SD}	I _{SD} = 50A		0.9	1.5	V
t _{rr}	I _{SD} = 25A, di/dt = 50A/μs		110		ns
C _{iss}	V _{DS} = 10V		9400		pF
C _{oss}	V _{GS} = 10V		1400		pF
C _{rss}	f = 1.0MHz		1100		pF

External Dimensions TO220S

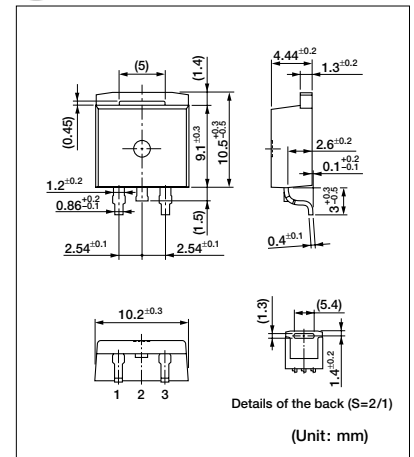

MOS FET 2SK3711

Features

- ON resistance 0.006Ω max.
- Built-in G-S bidirectional Zener diode
- Trench MOS structure

Applications

- Power steering motor
- Various motors
- Replaces mechanical relays

External Dimensions TO-3P

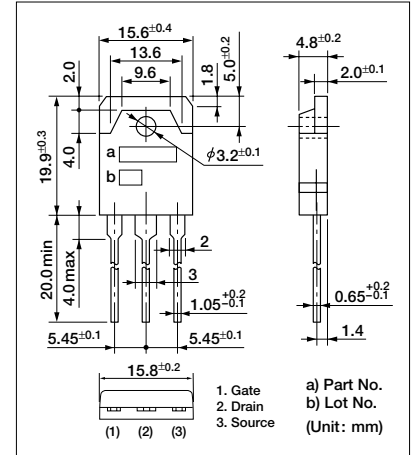

Absolute Maximum Ratings (Ta=25°C)

Symbol	Rating	Unit
V _{DSS}	60	V
V _{GSS}	20	V
I _D	70	A
I _{D (pulse)}	140	A
P _D	130	W
EAS	To be defined	mJ
T _{ch}	150	°C
T _{stg}	-55 to +150	°C

* 1: P_w ≤ 100μs, duty cycle ≤ 1%

* 2: V_{DD} = 20V, L = 1mH, I_L = 20A, unclamped, R_G = 50Ω

* Contact your sales rep for the details of warranty at T_{ch} = 175°C

Electrical Characteristics (Ta=25°C)

Symbol	Test Conditions	Ratings			Unit
		min	typ	max	
V _{(BR) DSS}	I _D = 100μA	60			V
I _{GSS}	V _{GS} = +20V			±10	μA
I _{DSS}	V _{DS} = 60V, V _{GS} = 0V			100	μA
V _{TH}	V _{DS} = 10V, I _D = 250μA	2		4	V
R _{DS (ON)}	V _{GS} = 10V, I _D = 35A		5.0	6.0	mΩ
V _{SD}	I _{SD} = 50A		0.9	1.2	V
t _{rr}	I _{SD} = 25A, di/dt = 50A/μs		70		ns
C _{iss}	V _{DS} = 10V			7800	pF
C _{oss}	V _{GS} = 10V			1250	pF
Cr _{ss}	f = 1.0MHz			990	pF

I_D — V_{DS} Characteristics (typ.)

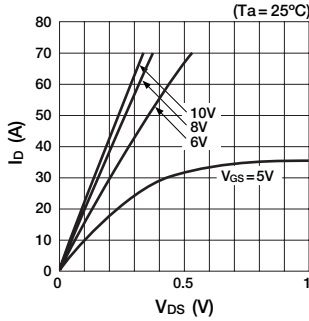

I_D — V_{GS} Characteristics (typ.)

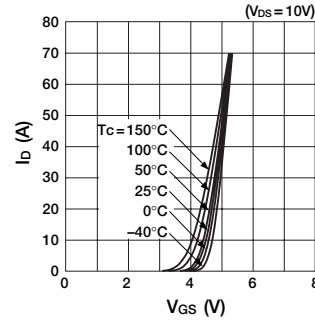

V_{DS} — V_{GS} Characteristics (typ.)

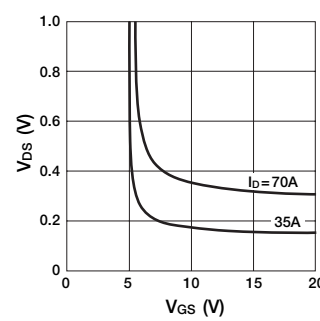

Re (yfs) — I_D Characteristics (typ.)

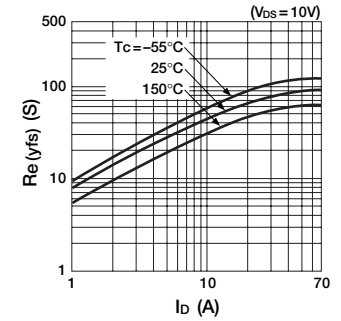

R_{DS (ON)} — I_D Characteristics (typ.)

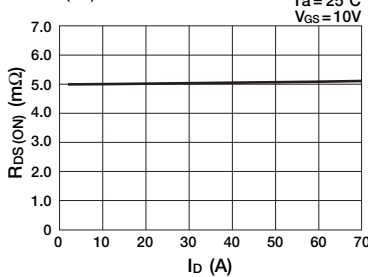

R_{DS (ON)} — T_C Characteristics (typ.)

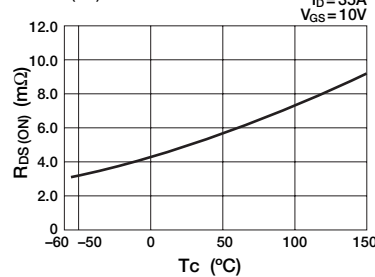

θ_{J-C} — P_w Characteristics

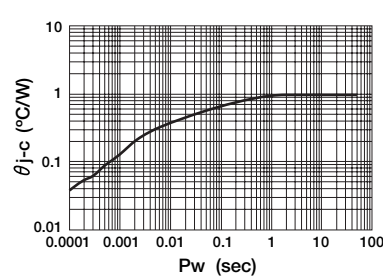

Capacitance — V_{DS} Characteristics

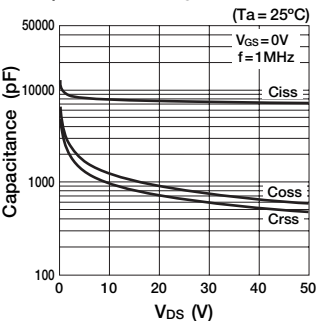

I_{DR} — V_{SD} Characteristics

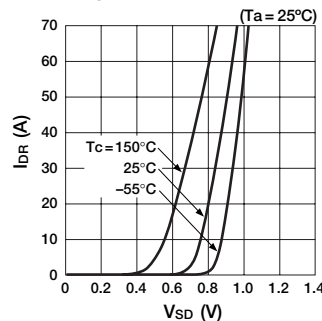

Safe Operating Area (single pulse)

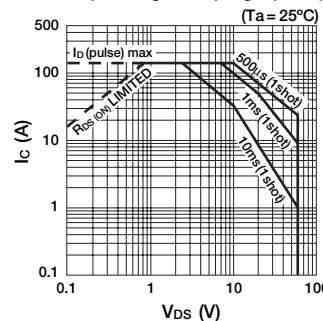

P_D — T_C Characteristics

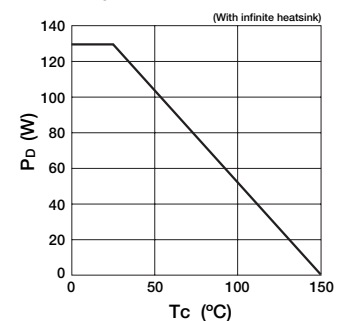

MOS FET 2SK3724 (under development)

Features

- ON resistance 0.005Ω max.
- Built-in G-S bidirectional Zener diode
- Trench MOS structure

Applications

- Power steering motor
- Various motors
- Replaces mechanical relays

Absolute Maximum Ratings (Ta=25°C)

Symbol	Ratings	Unit
V _{DSS}	60	V
V _{GSS}	20	V
I _D	80	A
I _D (pulse)	160	A
P _D	60	W
EAS	To be defined	mJ
T _{ch} *	150	°C
T _{stg}	-55 to +150	°C

* Contact your sales rep for the details of warranty at T_{ch}=175°C

Electrical Characteristics (Ta=25°C)

Symbol	Test Conditions	Ratings			Unit
		min	typ	max	
V _{(BR) DSS}	I _D = 100μA	60			V
I _{GSS}	V _{GS} = ±20V			±10	μA
I _{DSS}	V _{DS} = 60V, V _{GS} = 0V			100	μA
V _{TH}	V _{DS} = 10V, I _D = 1mA	1		2	V
R _{DS (ON)}	V _{GS} = 10V, I _D = 40A		4.0	5.0	mΩ
V _{SD}	I _{SD} = 50A		0.9	1.5	V
t _{rr}	I _{SD} = 25A, di/dt = 50A/μs		To be defined		ns
C _{iss}	V _{DS} = 10V		10600		pF
C _{oss}	V _{GS} = 10V		1600		pF
C _{rss}	f = 1.0MHz		1300		pF

External Dimensions TO220S

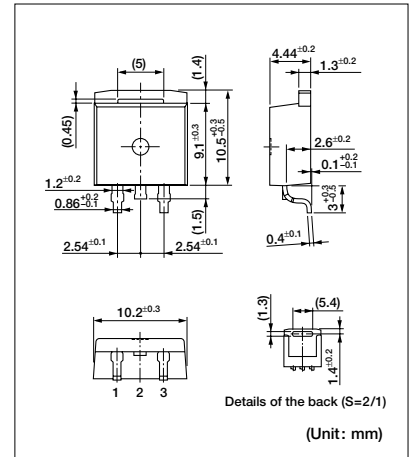

MOS FET 2SK3800

Absolute Maximum Ratings (Ta=25°C)

Symbol	Ratings	Unit
V _{DSS}	40	V
V _{GSS}	±20	V
I _D	±70	A
I _D (pulse)*1	±140	A
P _D	80 (Tc=25°C)	W
EAS*2	400	mJ
T _{ch}	150	°C
T _{stg}	-40 to +150	°C

*1: P_w ≤ 100μs, duty cycle ≤ 1%

*2: V_{DD} = 20V, L = 1mH, I_L = 20A, unclamped, R_θ = 50Ω

Electrical Characteristics (Ta=25°C)

Symbol	Test Conditions	Ratings			Unit
		min	typ	max	
V _{(BR) DSS}	I _D = 100μA, V _{GS} = 0V	40			V
I _{GSS}	V _{GS} = ±15V			±10	μA
I _{DSS}	V _{DS} = 40V, V _{GS} = 0V			100	μA
V _{TH}	V _{DS} = 10V, I _D = 1mA	2.0	3.0	4.0	V
R _e (yfs)	V _{DS} = 10V, I _D = 35A	30	50		S
R _{DS (ON)}	V _{GS} = 10V, I _D = 35A		5.0	6.0	mΩ
C _{iss}	V _{DS} = 10V		5100		pF
C _{oss}	f = 1.0MHz		1200		pF
C _{rss}	V _{GS} = 0V		860		pF
t _{d (on)}	I _D = 35A		100		ns
t _r	V _{DD} = 20V, R _G = 22Ω		100		ns
t _{d (off)}	R _L = 0.57Ω, V _{GS} = 10V		300		ns
t _f			130		ns
V _{SD}	I _{SD} = 50A, V _{GS} = 0V		0.9	1.2	V
t _{rr}	I _{SD} = 25A, di/dt = 50A/μs		110		ns
R _{th (ch-c)}				1.56	°C/W
R _{th (ch-a)}				62.5	°C/W

External Dimensions TO220S

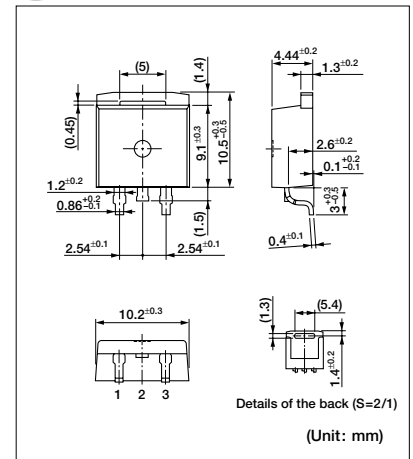

■ I_D—V_{DS} Characteristics (typ.)

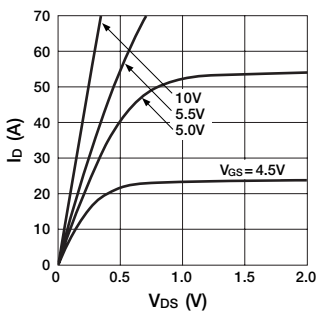

■ I_D—V_{GS} Characteristics (typ.)

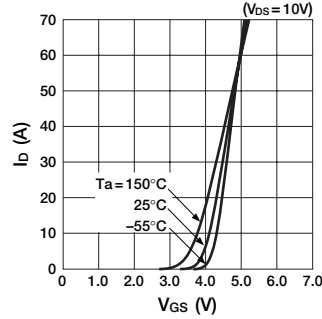

■ V_{DS}—V_{GS} Characteristics (typ.)

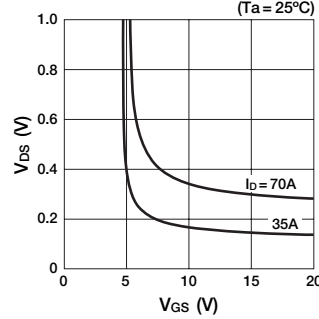

■ R_e (yfs) — I_D Characteristics (typ.)

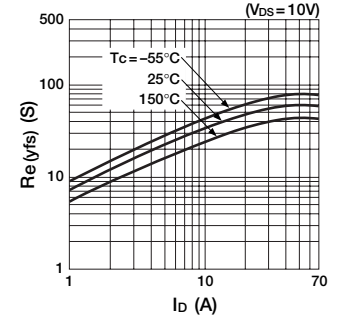

■ R_{DS (ON)} — I_D Characteristics (typ.)

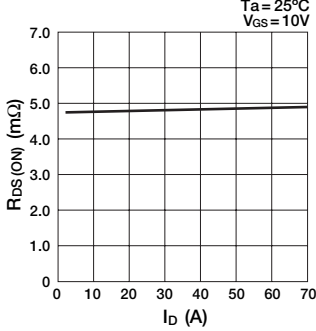

■ R_{DS (ON)} — T_C Characteristics (typ.)

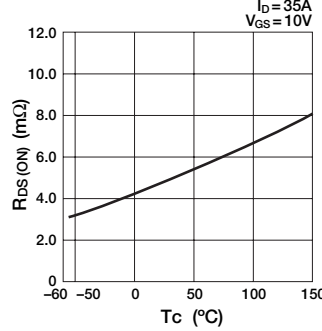

■ θ_{j-c} — t Characteristics (Single pulse)

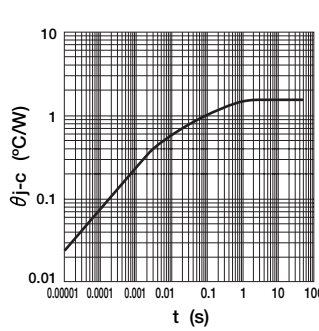

■ Dynamic I/O Characteristics (typ.)

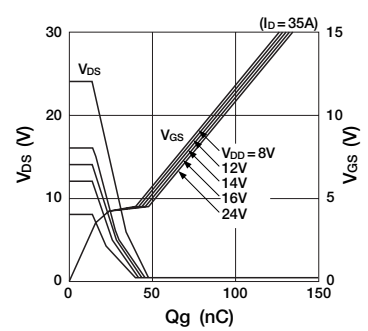

■ Capacitance—V_{DS} Characteristics (typ.)

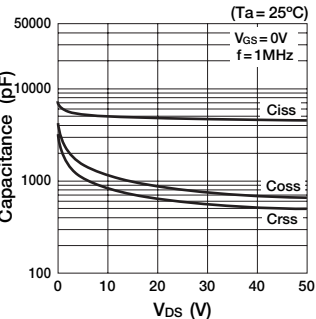

■ I_{DR}—V_{SD} Characteristics (typ.)

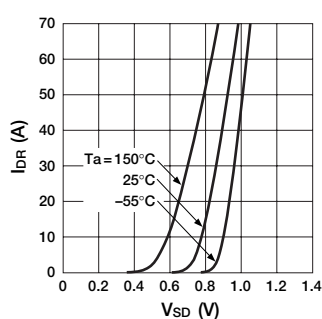

■ Safe Operating Area (single pulse)

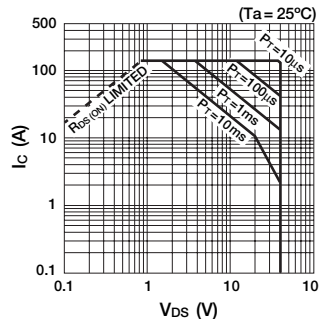

■ P_D—T_C Characteristics

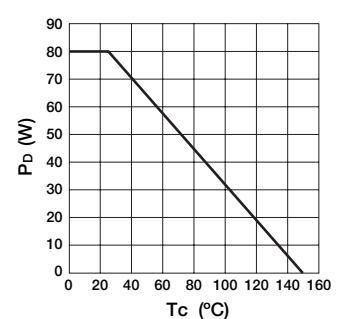

MOS FET 2SK3801

Absolute Maximum Ratings (Ta=25°C)

Symbol	Ratings	Unit
V _{DSS}	40	V
V _{GSS}	±20	V
I _D	±70	A
I _{D (pulse)*1}	±140	A
P _D	100 (Tc=25°C)	W
EAS*1	400	mJ
T _{ch}	150	°C
T _{stg}	-40 to +150	°C

* 1: P_w ≤ 100μs, duty cycle ≤ 1%

* 2: V_{DD} = 20V, L = 1mH, I_L = 20A, unclamped, R_G = 50Ω

Electrical Characteristics (Ta=25°C)

Symbol	Test Conditions	Ratings			Unit
		min	typ	max	
V _{(BR) DSS}	I _D = 100μA, V _{GS} = 0V	40			V
I _{GSS}	V _{GS} = ±15V			±10	μA
I _{DSS}	V _{DS} = 40V, V _{GS} = 0V			100	μA
V _{TH}	V _{DS} = 10V, I _D = 1mA	2.0	3.0	4.0	V
R _{e (yfs)}	V _{DS} = 10V, I _D = 35A	30	50		S
R _{DS (ON)}	V _{GS} = 10V, I _D = 35A		5.0	6.0	mΩ
C _{iss}	V _{DS} = 10V		5100		pF
C _{oss}	f = 1.0MHz		1200		pF
C _{rss}	V _{GS} = 0V		860		pF
t _{d (on)}	I _D = 35A		100		ns
t _r	V _{DD} = 20V, R _G = 22Ω		100		ns
t _{d (off)}	R _L = 0.57Ω, V _{GS} = 10V		300		ns
t _f			130		ns
V _{SD}	I _{SD} = 50A, V _{GS} = 0V		0.9	1.5	V
t _{rr}	I _{SD} = 25A, di/dt = 50A/μs		100		ns
R _{th (ch-c)}				1.25	°C/W
R _{th (ch-a)}				35.71	°C/W

External Dimensions TO-3P

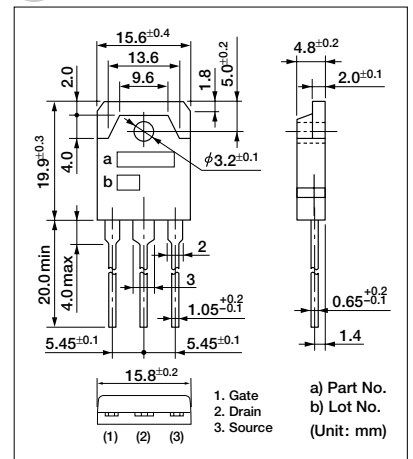

■ I_D — V_{DS} Characteristics (typ.)

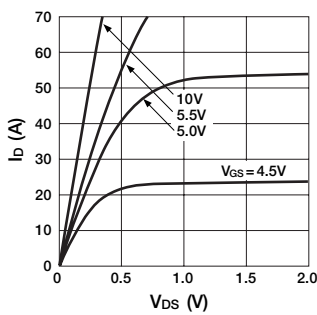

■ I_D — V_{GS} Characteristics (typ.)

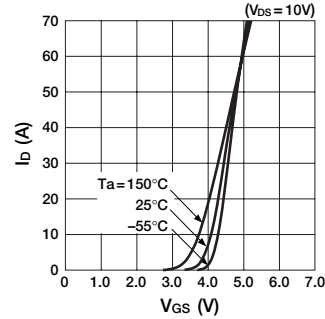

■ V_{DS} — V_{GS} Characteristics (typ.)

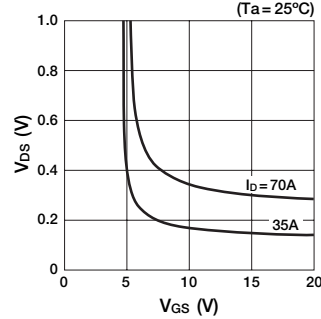

■ R_{e (yfs)} — I_D Characteristics (typ.)

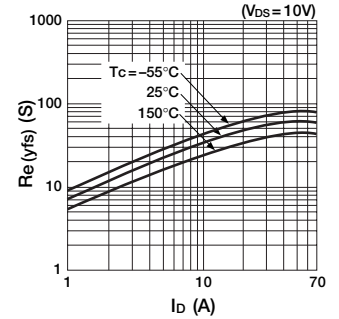

■ R_{DS (ON)} — I_D Characteristics (typ.)

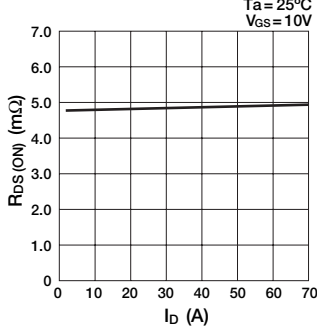

■ R_{DS (ON)} — T_c Characteristics (typ.)

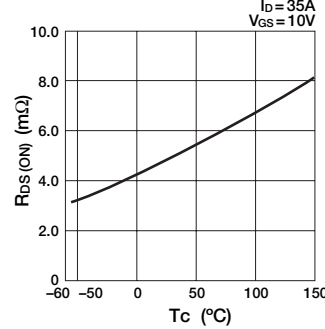

■ θ_{j-c} — P_w Characteristics (Single pulse)

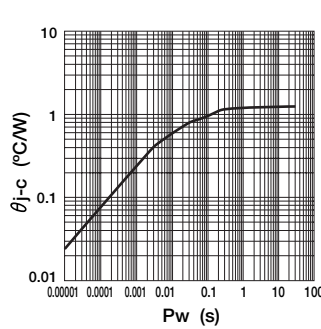

■ Dynamic I/O Characteristics (typ.)

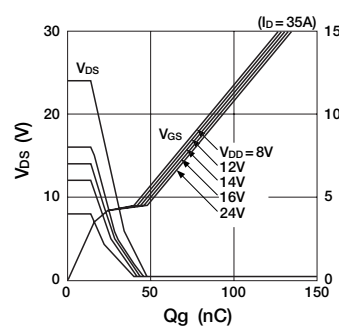

■ Capacitance — V_{DS} Characteristics (typ.)

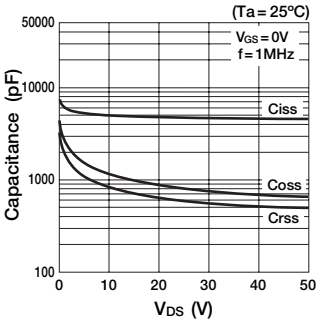

■ I_{DR} — V_{SD} Characteristics (typ.)

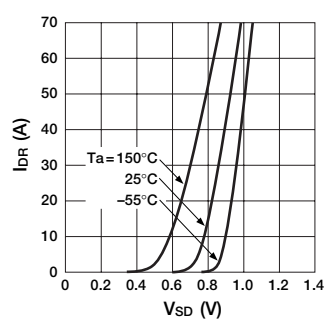

■ Safe Operating Area (single pulse)

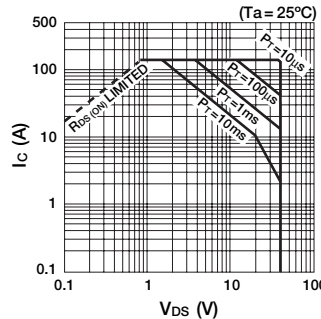

■ P_D — T_c Characteristics

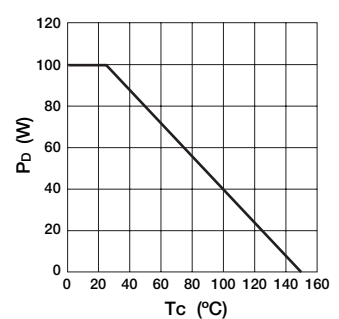

MOS FET 2SK3803 (under development)

Absolute Maximum Ratings (Ta=25°C)

Symbol	Ratings	Unit
V _{DSS}	40	V
V _{GSS}	±20	V
I _D	±85	A
I _{D (pulse)} *1	±170	A
P _D	100 (T _C =25°C)	W
EAS*2	730	mJ
T _{ch}	150	°C
T _{stg}	-55 to +150	°C

* 1: P_W ≤ 100 μs, duty cycle ≤ 1%

* 2: V_{DD} = 20V, L = 1mH, I_L = 20A, unclamped, R_G = 50Ω

Electrical Characteristics (Ta=25°C)

Symbol	Test Conditions	Ratings			Unit
		min	typ	max	
V _{(BR) DSS}	I _D = 100 μA, V _{GS} = 0V	40			V
I _{GSS}	V _{GS} = ±15V			±10	μA
I _{DSS}	V _{DS} = 40V, V _{GS} = 0V			100	μA
V _{TH}	V _{DS} = 10V, I _D = 1mA	2.0		4.0	V
R _{θ (yfs)}	V _{DS} = 10V, I _D = 42A	50			S
R _{DS (ON)}	V _{GS} = 10V, I _D = 42A		2.1	3.0	mΩ
C _{iss}	V _{DS} = 10V		10500		pF
C _{oss}	f = 1.0MHz		2400		pF
C _{rss}	V _{GS} = 0V		1900		pF
t _{d (on)}	I _D = 42A		90		ns
t _r	V _{DD} = 20V, R _G = 22Ω		230		ns
t _{d (off)}	V _{GS} = 10V		490		ns
t _f			760		ns
V _{SD}	I _{SD} = 50A, V _{GS} = 0V		0.85	1.2	V
t _{tr}	I _{SD} = 25A, di/dt = 50A/μs		90		ns

External Dimensions TO220S

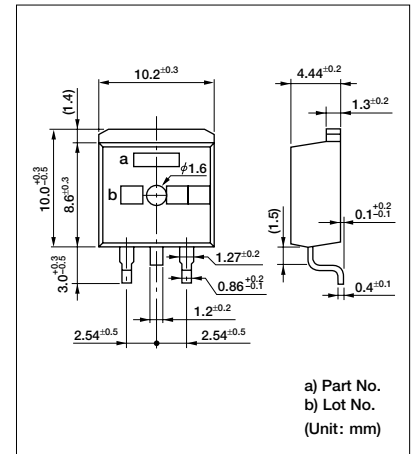

MOS FET 2SK3851

Absolute Maximum Ratings (Ta=25°C)

Symbol	Ratings	Unit
V _{DSS}	60	V
V _{GSS}	±20	V
I _D	±85	A
I _{D (pulse)*1}	±280	A
P _D	150	W
EAS*2	280	mJ
T _{ch}	150	°C
T _{stg}	-55 to +150	°C

*1: P_W ≤ 100μs, duty cycle ≤ 1%

*2: V_{DD} = 20V, L = 1mH, I_L = 20A, unclamped

Electrical Characteristics (Ta=25°C)

Symbol	Test Conditions	Ratings			Unit
		min	typ	max	
V _{(BR) DSS}	I _D = 100μA, V _{GS} = 0V	60			V
I _{GSS}	V _{GS} = ±20V			±10	μA
I _{DSS}	V _{DS} = 60V, V _{GS} = 0V			100	μA
V _{TH}	V _{DS} = 10V, I _D = 1mA	2.0	2.5	3.0	V
Re (yfs)	V _{DS} = 10V, I _D = 42A	30			S
R _{DS (ON)}	V _{GS} = 10V, I _D = 42A		4.0	4.7	mΩ
C _{iss}	V _{DS} = 10V		11500		pF
C _{oss}	f = 1.0MHz		1500		pF
C _{rss}	V _{GS} = 0V		1100		pF
t _{d (on)}	I _D = 42A		60		ns
t _r	V _{DD} = 16V		25		ns
t _{d (off)}	R _G = 22Ω		370		ns
t _f	V _{GS} = 10V		65		ns
V _{SD}	I _{SD} = 50A, V _{GS} = 0V		0.87	1.5	V
t _{tr}	I _{SD} = 50A, di/dt = 100A/μs		70		ns

External Dimensions TO-3P

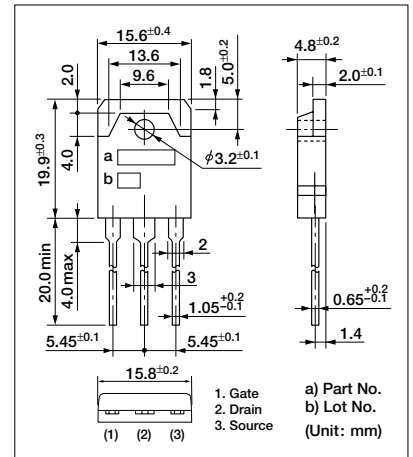

I_D—V_{DS} Characteristics (Ta=25°C)

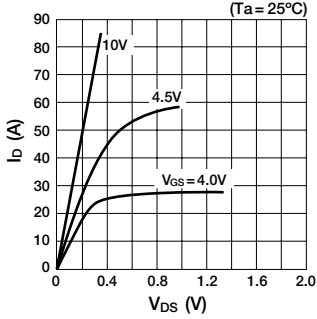

I_D—V_{GS} Characteristics (V_{DS} = 10V)

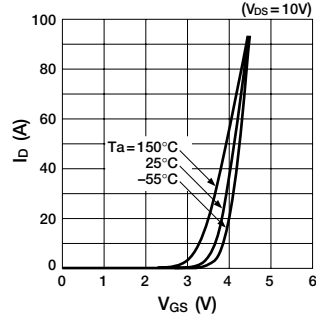

V_{DS}—V_{GS} Characteristics (Ta=25°C)

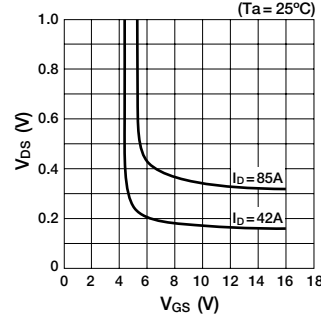

Re (yfs) — I_D Characteristics (V_{DS} = 10V)

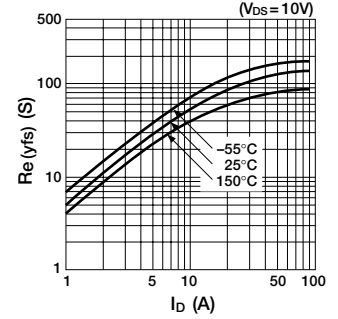

R_{DS (ON)} — I_D Characteristics (Ta=25°C, V_{GS} = 10V)

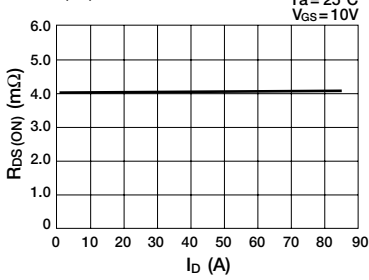

R_{DS (ON)} — T_C Characteristics (V_{GS} = 10V, I_D = 25A)

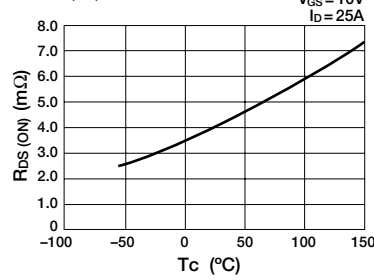

θ_{J-C} — t Characteristics (Single pulse)

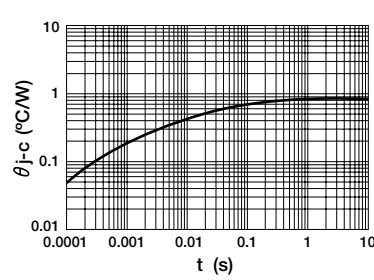

Capacitance—V_{DS} Characteristics (Ta=25°C, V_{GS} = 0V, f = 1MHz)

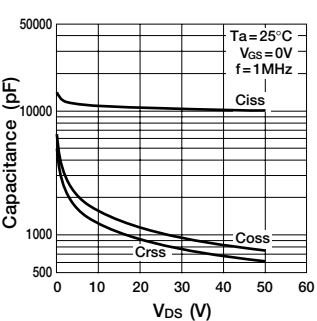

I_{DR}—V_{SD} Characteristics (Ta=25°C)

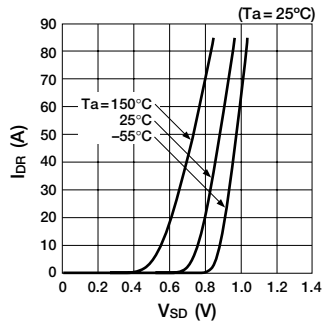

P_D—T_C Characteristics

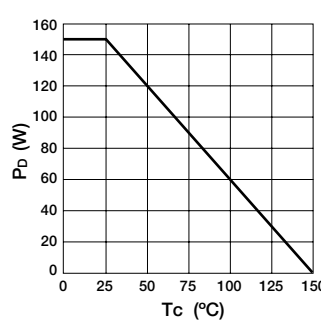

MOS FET FKV460S

Absolute Maximum Ratings (Ta=25°C)

Symbol	Ratings	Unit
V _{DSS}	40	V
V _{GSS}	+20, -10	V
I _D	±60	A
I _{D (pulse)*}	±180	A
P _D	60 (Tc=25°C)	W
T _{ch}	150	°C
T _{stg}	-55 to +150	°C

* P_W ≤ 100μs, duty ≤ 1%

Electrical Characteristics (Ta=25°C)

Symbol	Test Conditions	Ratings			Unit
		min	typ	max	
V _{(BR) DSS}	I _D = 100μA, V _{GS} = 0V	40			V
I _{GSS}	V _{GS} = +20V			+10	μA
	V _{GS} = -10V			-5	μA
I _{DSS}	V _{DS} = 40V, V _{GS} = 0V			100	μA
V _{TH}	V _{DS} = 10V, I _D = 250μA	1.3		2.3	V
R _{e (yfs)}	V _{DS} = 10V, I _D = 25A	20.0			S
R _{DS (ON)}	V _{GS} = 10V, I _D = 25A		7	9	mΩ
C _{iss}	V _{DS} = 10V		2800		pF
C _{oss}	f = 1.0MHz		1400		pF
C _{rss}	V _{GS} = 0V		600		pF
t _{d (on)}	I _D = 25A		20		ns
t _r	V _{DD} = 12V		600		ns
t _{d (off)}	R _L = 0.48Ω		250		ns
	V _{GS} = 10V		100		ns
V _{SD}	I _{SD} = 50A, V _{GS} = 0V	1.0		1.5	V

External Dimensions TO220S

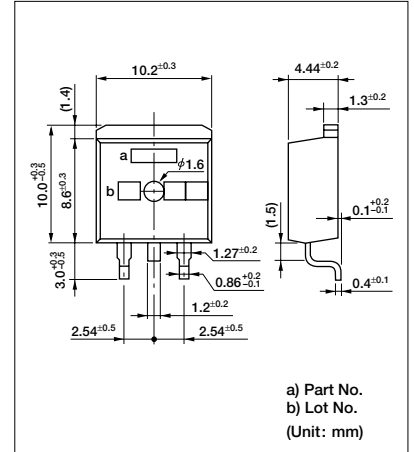

I_D — V_{DS} Characteristics (typ.)

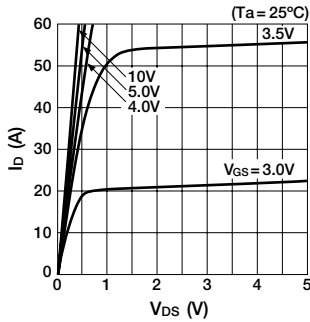

I_D — V_{GS} Characteristics (typ.)

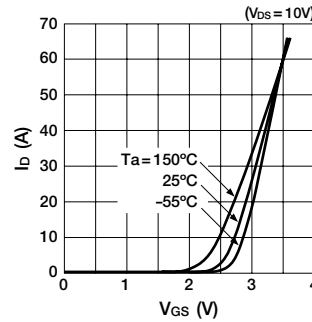

V_{DS} — V_{GS} Characteristics (typ.)

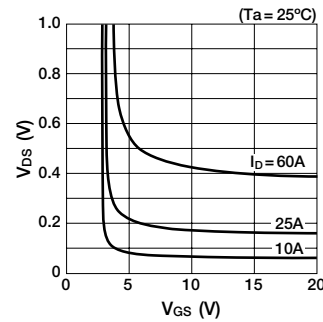

R_{e (yfs)} — I_D Characteristics

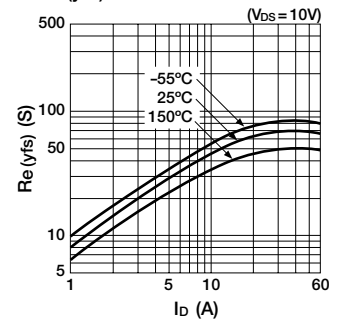

R_{DS (ON)} — I_D Characteristics

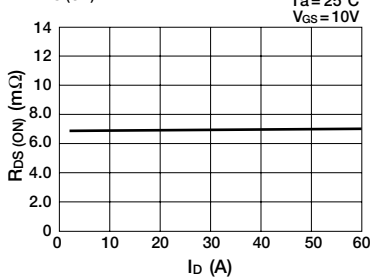

R_{DS (ON)} — T_C Characteristics

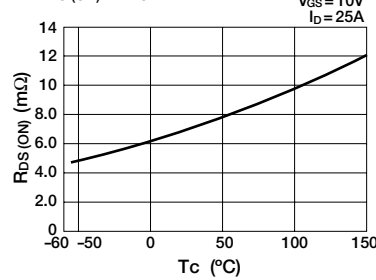

θ_{J-C} • θ_{J-A} — t Characteristics (Single pulse)

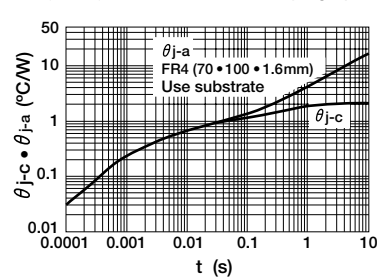

Capacitance — V_{DS} Characteristics

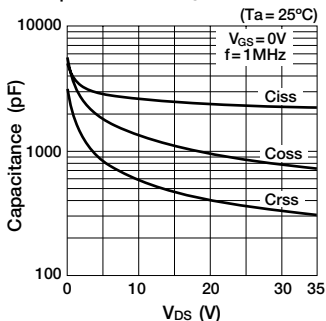

I_{DR} — V_{SD} Characteristics

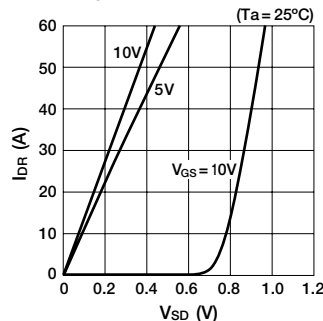

Safe Operating Area (single pulse)

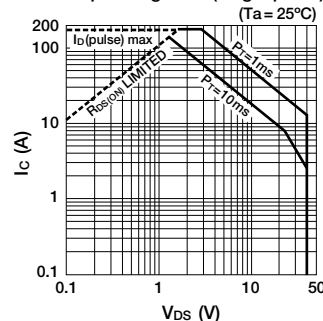

P_D — T_C Characteristics

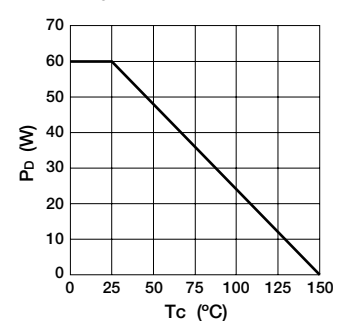

MOS FET FKV660S

Absolute Maximum Ratings (Ta=25°C)

Symbol	Ratings	Unit
V _{DSS}	60	V
V _{GSS}	+20, -10	V
I _D	±60	A
I _{D(pulse)} **	±180	A
P _D	60 (T _c =25°C)	W
T _{ch}	150	°C
T _{stg}	-40 to +150	°C

**P_w ≤ 100μs, duty ≤ 1%

Electrical Characteristics (Ta=25°C)

Symbol	Test Conditions	Ratings			Unit
		min	typ	max	
V _{(BR)DSS}	I _D =100μA, V _{GS} =0V	60			V
I _{GSS}	V _{GS} =+20V			+10	μA
	V _{GS} =-10V			-5	μA
I _{DSS}	V _{DS} =60V, V _{GS} =0V			100	μA
V _{TH}	V _{DS} =10V, I _D =250μA	1.0		2.5	V
R _e (y/fs)	V _{DS} =10V, I _D =25A	20			S
R _{DS(ON)}	V _{GS} =10V, I _D =25A		11	14	mΩ
C _{iss}	V _{DS} =10V		2500		pF
C _{oss}	f=1.0MHz		900		pF
C _{rss}	V _{GS} =0V		150		pF
t _{d(on)}	I _D =25A		50		ns
t _r	V _{DD} =12V		400		ns
t _{d(off)}	R _L =0.48Ω		400		ns
t _f	V _{GS} =10V		300		ns
V _{SD}	I _{SD} =50A, V _{GS} =0V	1.0	1.5		V

External Dimensions TO220S

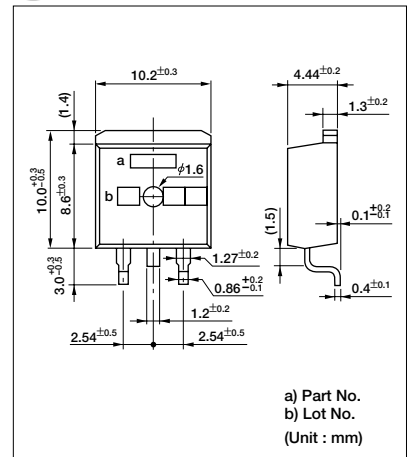

I_D—V_{DS} Characteristics (Ta=25°C)

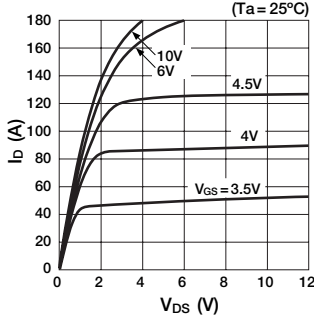

I_D—V_{GS} Characteristics (VDS=10V)

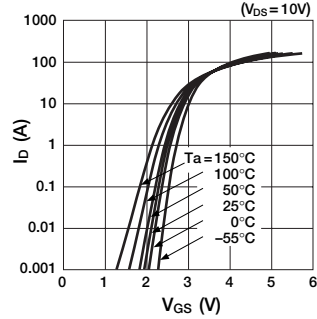

V_{DS}—V_{GS} Characteristics (Ta=25°C)

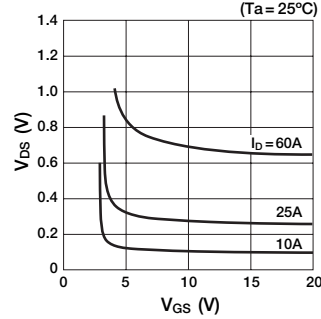

R_e (y/fs) — I_D Characteristics (VDS=10V)

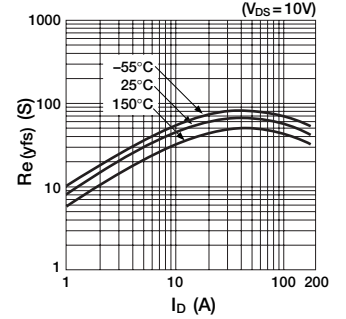

R_{DS(ON)} — I_D Characteristics (Ta=25°C)

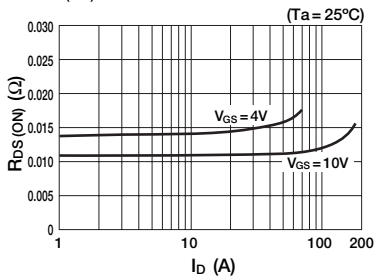

R_{DS(ON)} — T_c Characteristics (ID=25A)

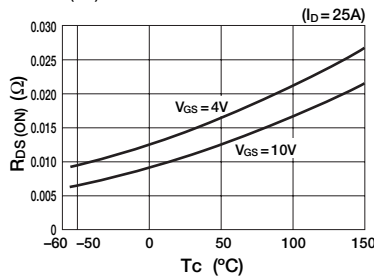

Capacitance — V_{DS} Characteristics (Ta=25°C)

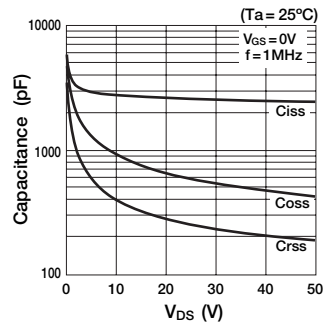

I_{DR} — V_{SD} Characteristics (Ta=25°C, VGS=0V)

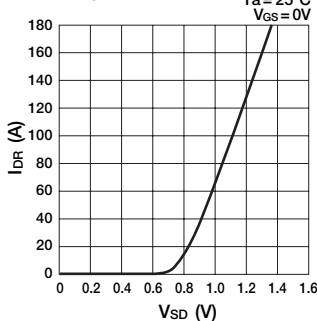

Safe Operating Area (single pulse) (Ta=25°C)

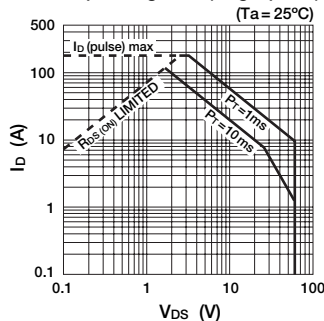

Surface-mount MOS FET Array SDK06

Absolute Maximum Ratings (Ta=25°C)

Symbol	Ratings	Unit
V _{DSS}	52±5	V
V _{GSS}	±20	V
I _D	±3	A
I _{D (pulse)*1}	±6	A
PT	3 (Tc=25°C, 4 circuits operate)	W
EAS*2	40	mJ
T _{ch}	150	°C
T _{stg}	-55 to +150	°C

*1 P_W ≤ 100μs, duty ≤ 1%

*2 V_{DD} = 12V, L = 10mH, unclamped, R_G = 10Ω

Electrical Characteristics (Ta=25°C)

Symbol	Test Conditions	Ratings			Unit
		min	typ	max	
V _{(BR) DSS}	I _D = 1mA, V _{GS} = 0V	47	52	57	V
I _{GSS}	V _{GS} = ±20V			±1.0	μA
I _{DSS}	V _{DS} = 40V, V _{GS} = 0V			100	μA
V _{TH}	V _{DS} = 10V, I _D = 250μA	1.0	1.8	2.5	V
Re (yfs)	V _{DS} = 10V, I _D = 1.0A	1.0			S
R _{DS (ON)}	V _{GS} = 10V, I _D = 1.0A		0.2	0.25	Ω
	V _{GS} = 4V, I _D = 1.0A		0.25	0.3	Ω
C _{iss}	V _{DS} = 10V		200		pF
C _{oss}	f = 1.0MHz		120		pF
C _{rss}	V _{GS} = 0V		20		pF
t _{d (on)}	I _D = 1A		2.0		μs
t _r	V _{DD} = 12V R _L = 12Ω		7.4		μs
t _{d (off)}	V _{GS} = 5V		3.3		μs
t _f	R _{G1} = 50Ω, R _{G2} = 10kΩ		4.2		μs
V _{SD}	I _{SD} = 1A, V _{GS} = 0V	1.0	1.5		V

External Dimensions SMD-16A

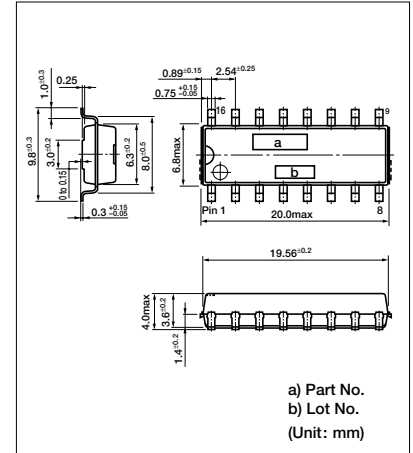

I_D—V_{DS} Characteristics

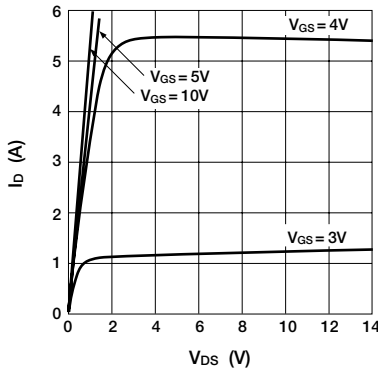

I_D—V_{GS} Characteristics

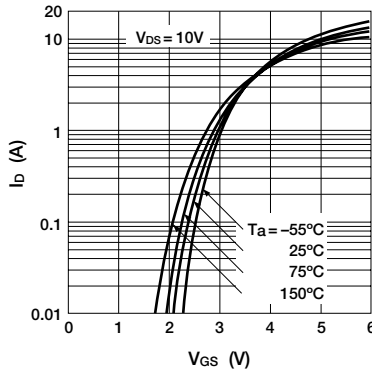

R_{DS (ON)}—I_D Characteristics

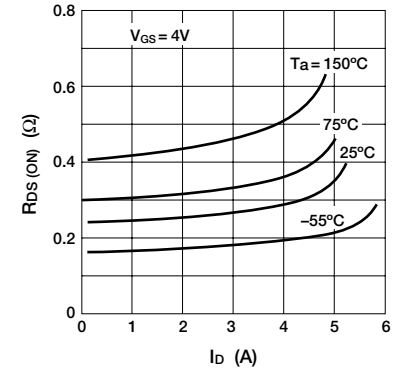

R_{DS (ON)}—T_C Characteristics

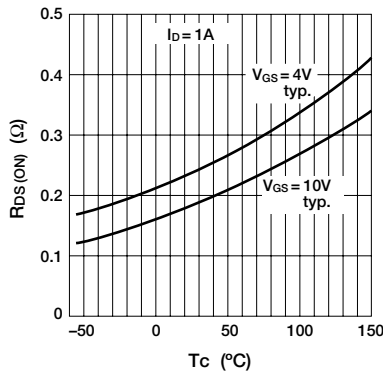

Re (yfs) — I_D Characteristics

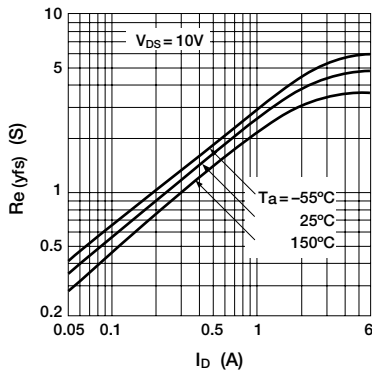

I_{DR}—V_{SD} Characteristics

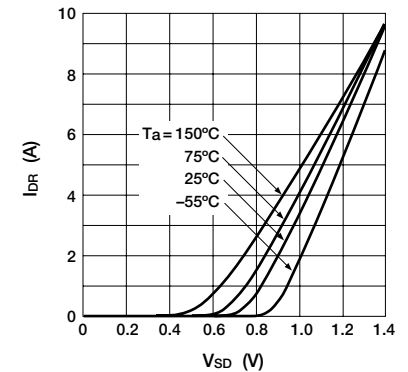

Safe Operating Area (single pulse)

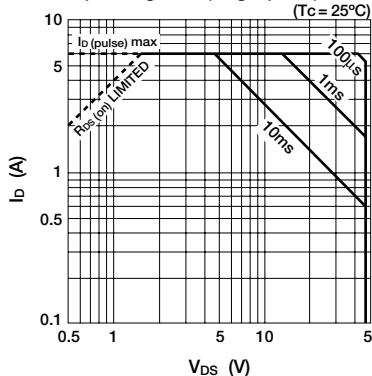

Equivalent Circuit Diagram

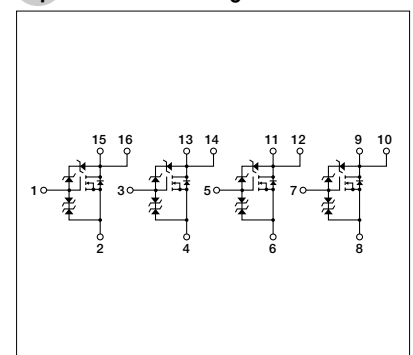

Surface-mount MOS FET Array SDK08

Absolute Maximum Ratings (Ta=25°C)

Symbol	Ratings	Unit
V _{DSS}	50	V
V _{GSS}	±20	V
I _D	±4.5	A
I _D (pulse)*1	±9	A
P _T	4 (Tc=25°C, 4 circuits operate)	W
E _{AS} *2	80	mJ
T _{ch}	150	°C
T _{stg}	-55 to +150	°C

*1 P_w ≤ 100μs, duty ≤ 1%

*2 V_{DD} = 12V, L = 10mH, unclamped, R_G = 50Ω

Electrical Characteristics (Ta=25°C)

Symbol	Test Conditions	Ratings			Unit
		min	typ	max	
V _{(BR) DSS}	I _D = 100μA, V _{GS} = 0V	50			V
I _{GSS}	V _{GS} = ±20V			±100	nA
I _{DSS}	V _{DS} = 50V, V _{GS} = 0V			100	μA
V _{TH}	V _{DS} = 10V, I _D = 1mA	1.3	1.8	2.3	V
Re (yfs)	V _{DS} = 10V, I _D = 4.0A	5.0	9.0	13.0	S
R _{DS (ON)}	V _{GS} = 10V, I _D = 4.0A		0.07	0.08	Ω
	V _{GS} = 4V, I _D = 4.0A		0.09	0.1	Ω
C _{iss}	V _{DS} = 10V		700		pF
C _{oss}	f = 1.0MHz		300		pF
C _{rss}	V _{GS} = 0V		90		pF
t _{d (on)}	I _D = 4A		50		ns
t _r	V _{DD} = 12V R _L = 3Ω		80		ns
t _{d (off)}	V _{GS} = 5V		60		ns
t _f	R _G = 50Ω		40		ns
V _{SD}	I _{SD} = 6A, V _{GS} = 0V	1.0	1.5		V

External Dimensions SMD-16A

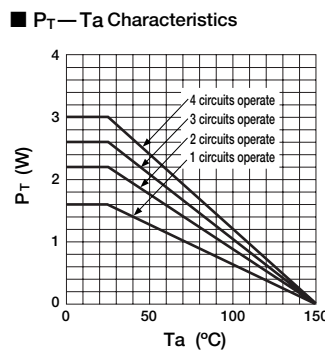
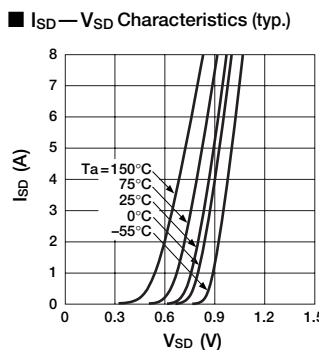
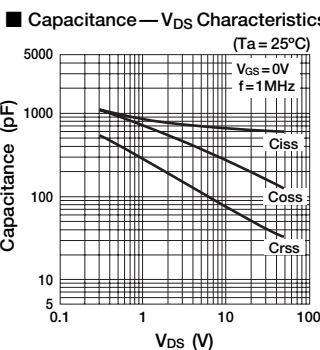
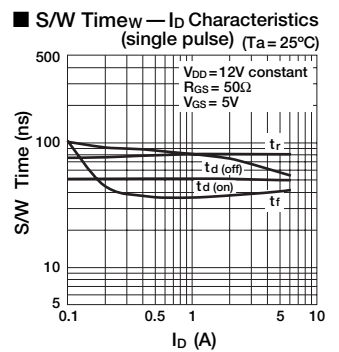
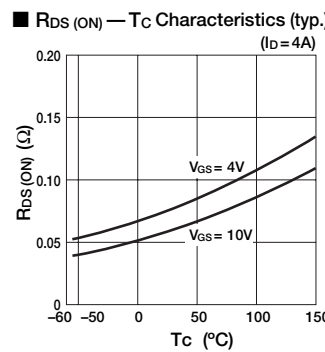
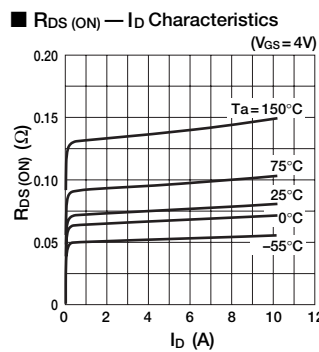
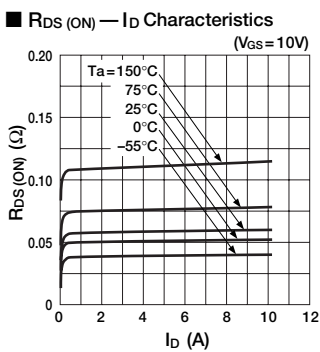
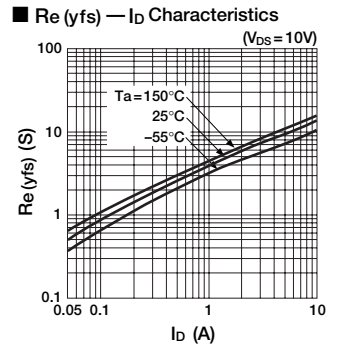
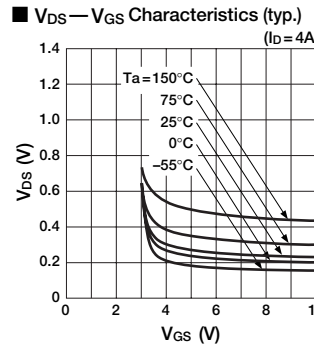
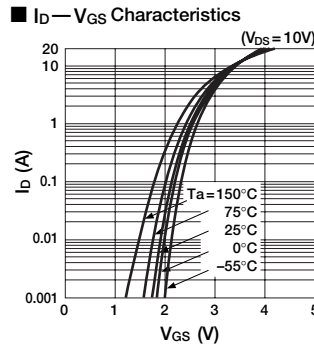
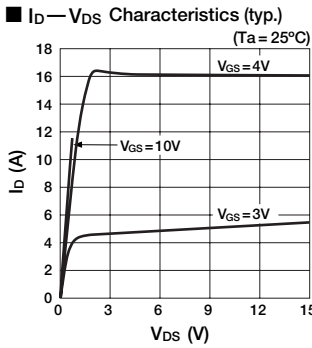
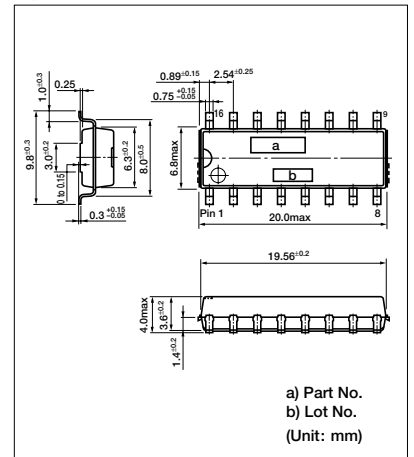

Equivalent Circuit Diagram

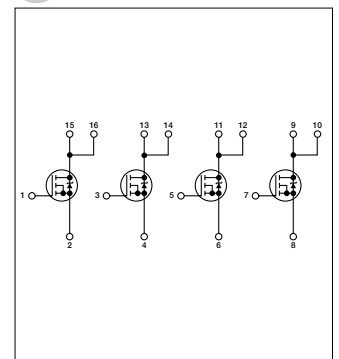

Surface-mount MOS FET Array SDK09

Absolute Maximum Ratings (Ta=25°C)

Symbol	Rating	Unit
V _{DSS}	120	V
V _{GSS}	±20	V
I _D	±6	A
I _{D (pulse)*1}	±10	A
P _T	3 (Tc=25°C, 4 circuits operate)	W
E _{AS} *2	80	mJ
T _{ch}	150	°C
T _{stg}	-55 to +150	°C

*1 P_W ≤ 100μs, duty ≤ 1%

*2 V_{DD} = 12V, L = 10mH, unclamped, R_G = 50Ω

Electrical Characteristics (Ta=25°C)

Symbol	Test Conditions	Rating			Unit
		min	typ	max	
V _{(BR) DSS}	I _D = 100μA, V _{GS} = 0V	120			V
I _{GSS}	V _{GS} = ±20V			±5	μA
I _{DSS}	V _{DS} = 120V, V _{GS} = 0V			100	μA
V _{TH}	V _{DS} = 10V, I _D = 250μA	1.0		2.0	V
Re (yfs)	V _{DS} = 10V, I _D = 4A	5.0			S
R _{DS (ON)}	V _{GS} = 10V, I _D = 4A		0.15	0.2	Ω
	V _{GS} = 4V, I _D = 4A		0.2	0.25	
C _{iss}	V _{DS} = 10V		400		pF
C _{oss}	f = 1.0MHz		130		pF
C _{rss}	V _{GS} = 0V		30		pF
t _{d (on)}	I _D = 4A		100		ns
t _r	V _{DD} = 12V R _L = 3Ω		300		ns
t _{d (off)}	V _{GS} = 5V R _G = 50Ω		250		ns
t _f	R _G = 50Ω		200		ns
V _{SD}	I _{SD} = 6A, V _{GS} = 0V	1.0	1.5		V

External Dimensions SMD-16A

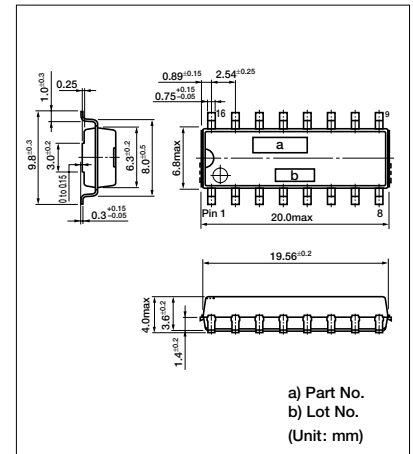

I_D — V_{DS} Characteristics

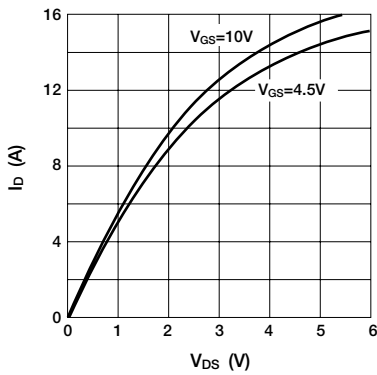

I_D — V_{GS} Characteristics

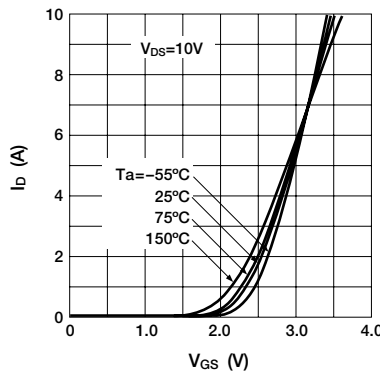

R_{DS (ON)} — I_D Characteristics

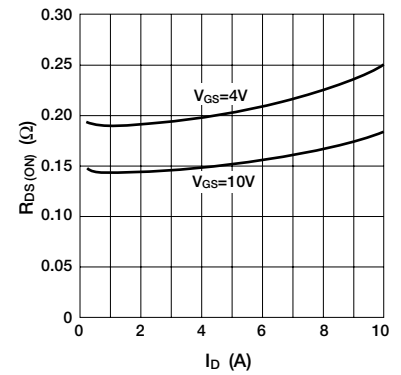

R_{DS (ON)} — T_C Characteristics

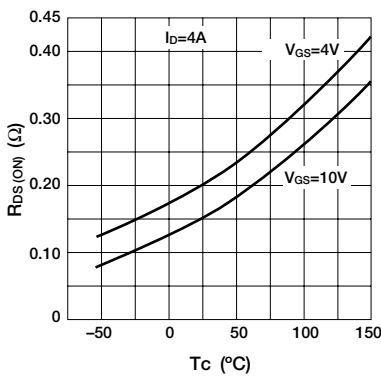

Re (yfs) — I_D Characteristics

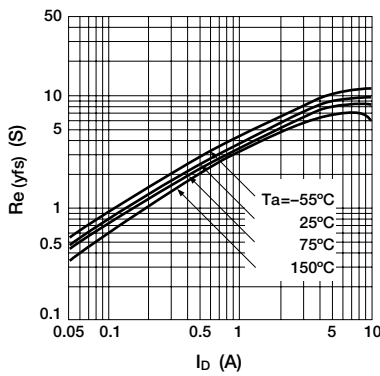

I_{DR} — V_{SD} Characteristics

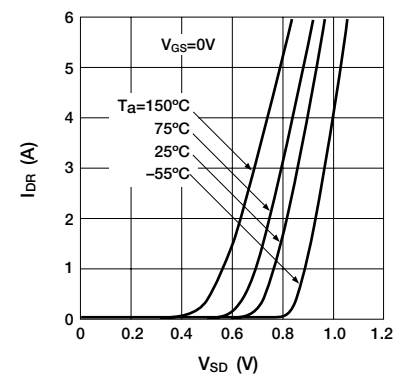

Capacitance — V_{DS} Characteristics

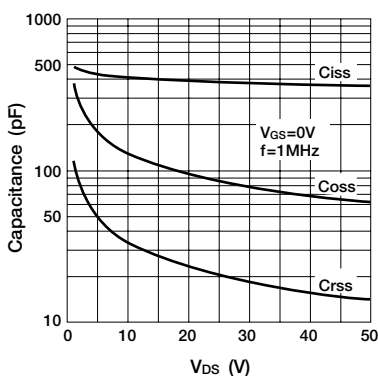

Safe Operating Area (single pulse)

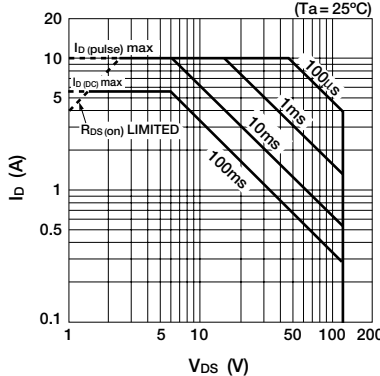

Equivalent Circuit Diagram

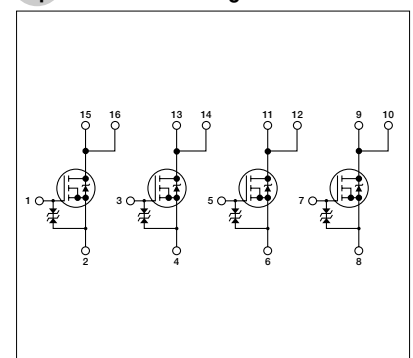

MOS FET Array SLA5027

Absolute Maximum Ratings (Ta=25°C)

Symbol	Ratings	Unit
V _{DSS}	60	V
V _{GSS}	±20	V
I _D	±12	A
I _D (pulse)*1	±48	A
P _T	5 (Ta=25°C, 4 circuits operate)	W
	60 (Tc=25°C, 4 circuits operate)	W
E _{AS} *2	250	mJ
θ _{j-c}	2.08	°C/W
V _{ISO}	(Fin to lead terminal) AC1000	V _{rms}
T _{ch}	150	°C
T _{stg}	-55 to +150	°C

*1 P_W ≤ 250μs, duty ≤ 1%

*2 V_{DD} = 30V, L = 10mH, unclamped, R_G = 50Ω

Electrical Characteristics (Ta=25°C)

Symbol	Test Conditions	Ratings			Unit
		min	typ	max	
V _{(BR) DSS}	I _D = 100μA, V _{GS} = 0V	60			V
I _{GSS}	V _{GS} = ±20V			±100	μA
I _{DSS}	V _{DS} = 60V, V _{GS} = 0V			100	μA
V _{TH}	V _{DS} = 10V, I _D = 1mA	1.0	1.5	2.0	V
Re (yfs)	V _{DS} = 10V, I _D = 8A	6.0	12.0		S
R _{DS (ON)}	V _{GS} = 4V, I _D = 8A		0.07	0.08	Ω
C _{iss}	V _{DS} = 10V			1100	pF
C _{oss}	f = 1.0MHz			500	pF
C _{rss}	V _{GS} = 0V			170	pF
t _{d (on)}	I _D = 8A V _{DD} = 30V			50	ns
t _r	R _L = 3.75Ω			250	ns
t _{d (off)}	V _{GS} = 5V			250	ns
t _f	R _G = 50Ω			180	ns
V _{SD}	I _{SD} = 10A, V _{GS} = 0V		1.0	1.5	V

External Dimensions SLA 12pin (LF800)

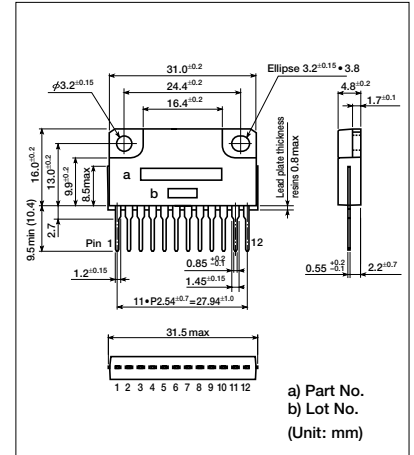

I_D—V_{DS} Characteristics

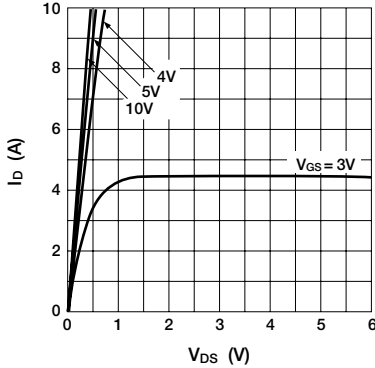

I_D—V_{GS} Characteristics

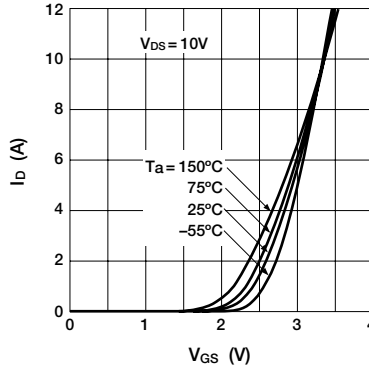

R_{DS (ON)}—I_D Characteristics

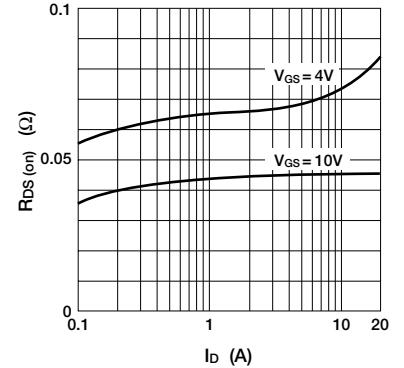

R_{DS (ON)}—T_c Characteristics

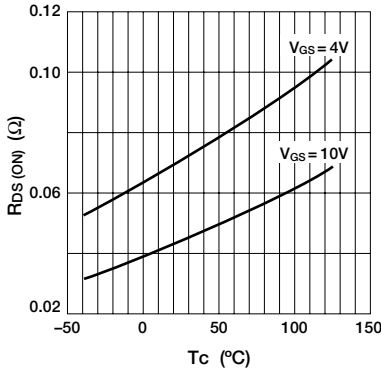

Re (yfs)—I_D Characteristics

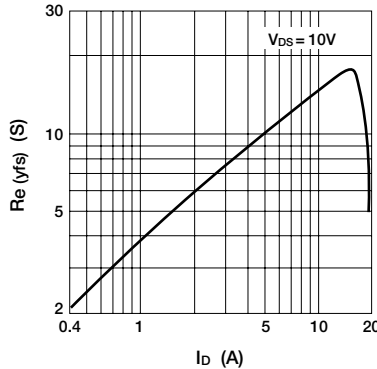

I_{DR}—V_{SD} Characteristics

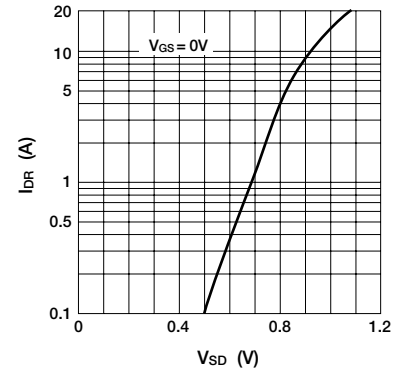

Capacitance—V_{DS} Characteristics

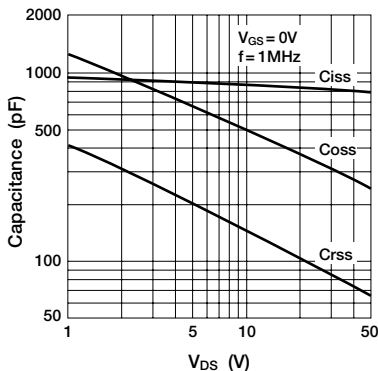

Safe Operating Area (single pulse)

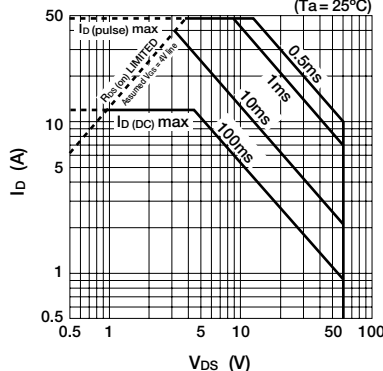

Equivalent Circuit Diagram

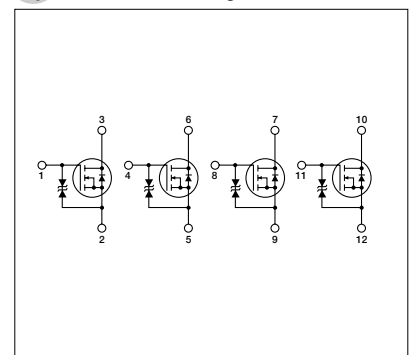

MOS FET Array SLA5098 (under development)

Absolute Maximum Ratings (Ta=25°C)

Symbol	Rating	Unit
V _{DSS}	40	V
V _{GSS}	±20	V
I _D	20	A
I _{D (pulse)*}	40	A
EAS	To be defined	mJ
IAS	To be defined	A
P _T	5 (Without heatsink, Ta=25°C, All circuits operate)	W
	90 (Ta=25°C, All circuits operate)	W
T _{ch}	150	°C
T _{stg}	-55 to +150	°C

* P_w ≤ 100μs, duty ≤ 1%

Electrical Characteristics (Ta=25°C)

Symbol	Test Conditions	Ratings			Unit
		min	typ	max	
V _{(BR) DSS}	I _D = 100μA, V _{GS} = 0V	40			V
I _{GSS}	V _{GS} = ±15V			±10	μA
I _{DSS}	V _{DS} = 40V, V _{GS} = 0V			100	μA
V _{TH}	V _{DS} = 10V, I _D = 250μA	1.5		2.5	V
R _{e (yfs)}	V _{DS} = 10V, I _D = 10A	10			S
R _{DS (ON)}	V _{GS} = 10V, I _D = 10A			17	mΩ
C _{iss}	V _{DS} = 10V		1450		pF
C _{oss}	f = 1.0MHz		420		pF
C _{rss}	V _{GS} = 0V		260		pF
t _{d (on)}	I _D = 10A		40		ns
t _r	V _{DD} = 14V		40		ns
t _{d (off)}	R _L = 1.4Ω		200		ns
t _f	V _{GS} = 10V		100		ns
	R _G = 50Ω				
V _{SD}	I _{SD} = 10A, V _{GS} = 0V		0.85	1.2	V
t _{rr}	I _{SD} = 10A, V _{GS} = 0V		45		ns
	di/dt = 100A/μs				

External Dimensions STA4 (LF412)

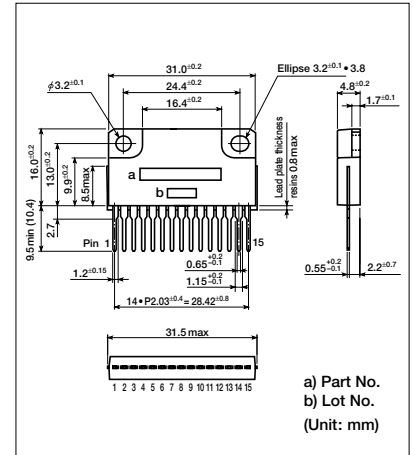

Equivalent Circuit Diagram

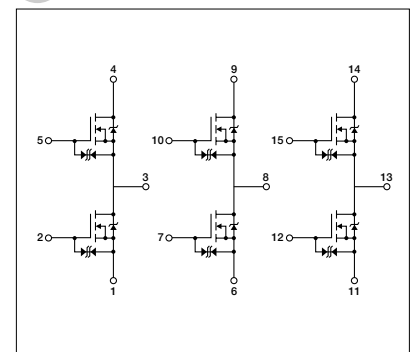

MOS FET Array STA508A

Absolute Maximum Ratings (Ta=25°C)

Symbol	Ratings	Unit
V _{DSS}	120	V
V _{GSS}	±20	V
I _D	±6	A
I _D (pulse)*1	±10	A
P _T	4 (Ta = 25°C)	W
	20 (Tc = 25°C)	W
E _{AS} *2	80	mJ
T _{ch}	150	°C
T _{stg}	-55 to +150	°C

*1 P_W ≤ 100μs, duty ≤ 1%

*2 V_{DD} = 12V, L = 10mH, unclamped, R_G = 50Ω

Electrical Characteristics (Ta=25°C)

Symbol	Test Conditions	Ratings			Unit
		min	typ	max	
V _{(BR)DSS}	I _D = 100μA, V _{GS} = 0V	120			V
I _{GSS}	V _{GS} = ±20V			±5	μA
I _{DSS}	V _{DS} = 120V, V _{GS} = 0V			100	μA
V _{TH}	V _{DS} = 10V, I _D = 250μA	1.0		2.0	V
Re (yfs)	V _{DS} = 10V, I _D = 4.0A	5.0			S
R _{DS(ON)}	V _{GS} = 10V, I _D = 4.0A		0.15	0.2	Ω
	V _{GS} = 4V, I _D = 4.0A		0.2	0.25	Ω
C _{iss}	V _{DS} = 10V		400		pF
C _{oss}	f = 1.0MHz		130		pF
C _{rss}	V _{GS} = 0V		30		pF
t _{d(on)}	I _D = 4A		100		ns
t _r	V _{DD} = 12V R _L = 3Ω		300		ns
t _{d(off)}	V _{GS} = 5V R _G = 50Ω		250		ns
t _f	V _{GS} = 5V R _G = 50Ω		200		ns
V _{SD}	I _{SD} = 6A, V _{GS} = 0V	1.0	1.5		V

External Dimensions STA4 (LF412)

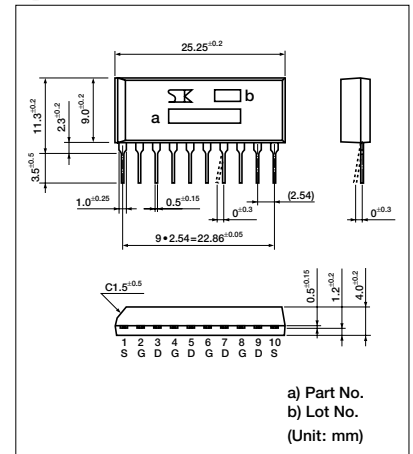

a) Part No.
b) Lot No.
(Unit: mm)

I_D—V_{DS} Characteristics

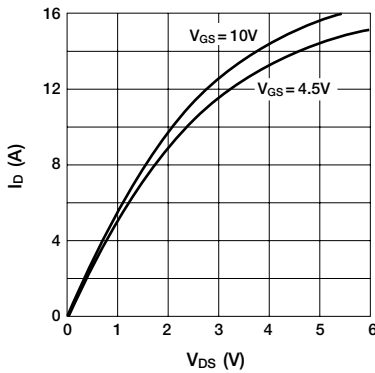

I_D—V_{GS} Characteristics

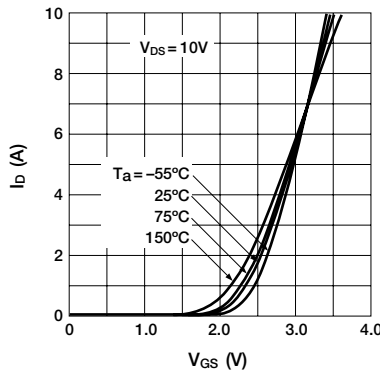

R_{DS(ON)}—I_D Characteristics

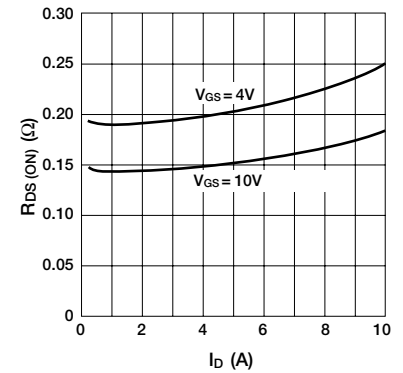

R_{DS(ON)}—T_c Characteristics

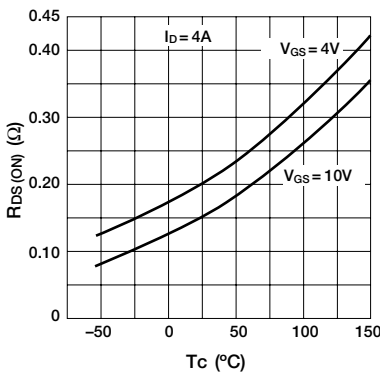

Re (yfs)—I_D Characteristics

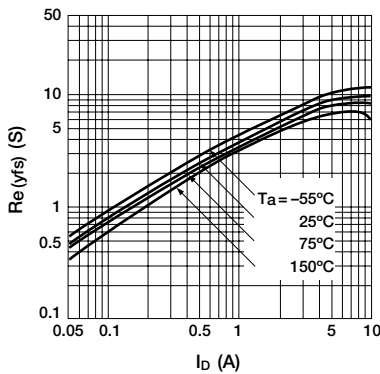

I_{DR}—V_{SD} Characteristics

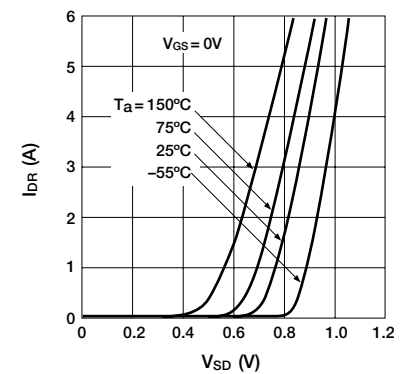

Capacitance—V_{DS} Characteristics

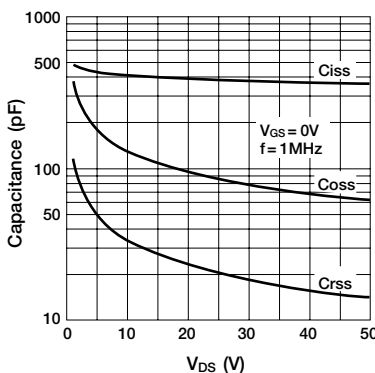

Safe Operating Area (single pulse)

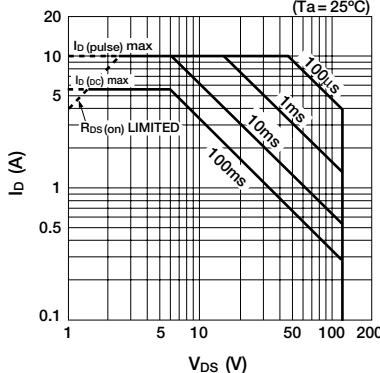

Equivalent Circuit Diagram

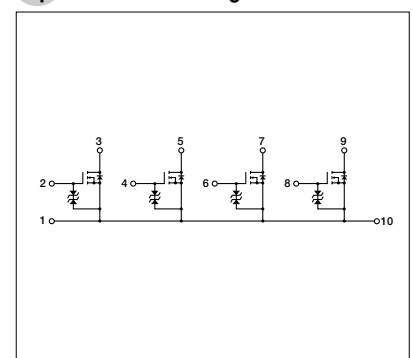

MOS FET Array STA509A

Absolute Maximum Ratings (Ta=25°C)

Symbol	Ratings	Unit
V _{DSS}	52±5	V
V _{GSS}	±20	V
I _D	±3	A
I _D (pulse)*1	±6	A
P _T	4 (Ta = 25°C)	W
	20 (Tc = 25°C)	W
E _{AS} *2	40	mJ
T _{ch}	150	°C
T _{stg}	-55 to +150	°C

*1 P_W ≤ 100μs, duty ≤ 1%

*2 V_{DD} = 12V, L = 10mH, unclamped, R_G = 10Ω

Electrical Characteristics (Ta=25°C)

Symbol	Test Conditions	Ratings			Unit
		min	typ	max	
V _{(BR) DSS}	I _D = 1mA, V _{GS} = 0V	47	52	57	V
I _{GSS}	V _{GS} = ±20V			±1.0	μA
I _{DSS}	V _{DS} = 40V, V _{GS} = 0V			100	μA
V _{TH}	V _{DS} = 10V, I _D = 250μA	1.0		2.5	V
R _e (y/s)	V _{DS} = 10V, I _D = 1.0A	1.0			S
R _{DS(ON)}	V _{GS} = 10V, I _D = 1.0A		0.2	0.25	Ω
	V _{GS} = 4V, I _D = 1.0A		0.25	0.3	Ω
C _{iss}	V _{DS} = 10V		200		pF
C _{oss}	f = 1.0MHz		120		pF
C _{rss}	V _{GS} = 0V		20		pF
t _{d(ON)}	I _D = 1A		2.0		μs
t _r	V _{DD} = 12V		7.4		μs
t _{d(OFF)}	R _L = 12Ω		3.3		μs
t _f	V _{GS} = 5V		4.2		μs
	R _{G1} = 50Ω, R _{G2} = 10Ω				μs
V _{SD}	I _{SD} = 6A, V _{GS} = 0V	1.0	1.5		V

External Dimensions STA

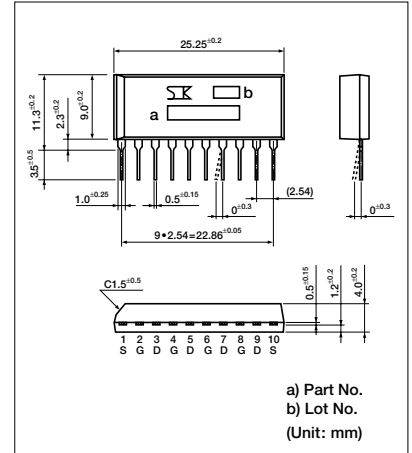

I_D—V_{DS} Characteristics

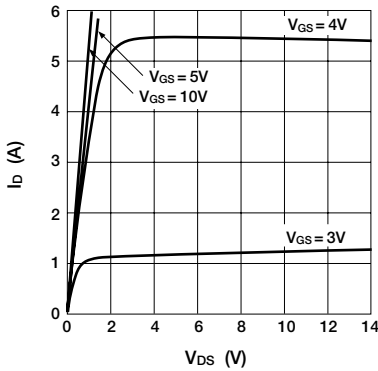

I_D—V_{GS} Characteristics

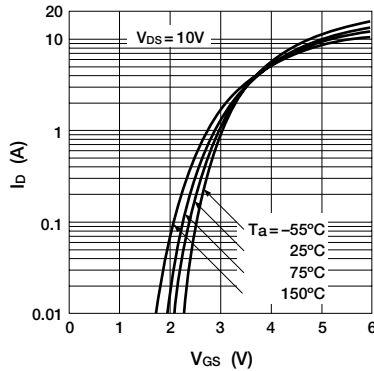

R_{DS(ON)}—I_D Characteristics

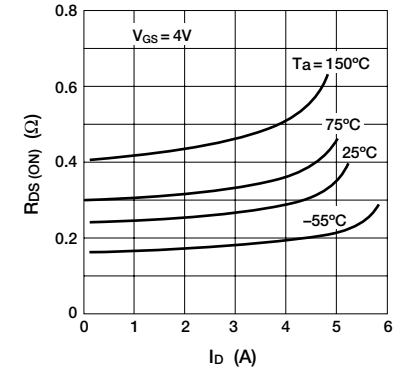

R_{DS(ON)}—T_C Characteristics

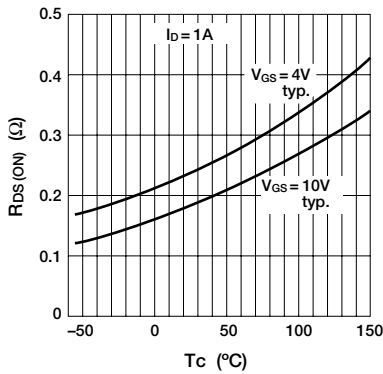

R_e (y/s)—I_D Characteristics

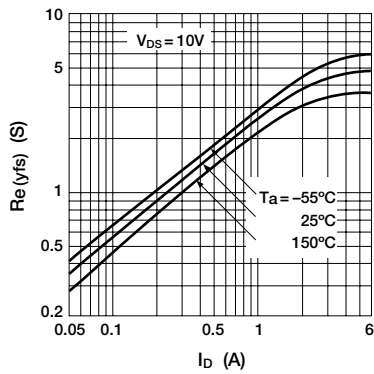

I_{DR}—V_{SD} Characteristics

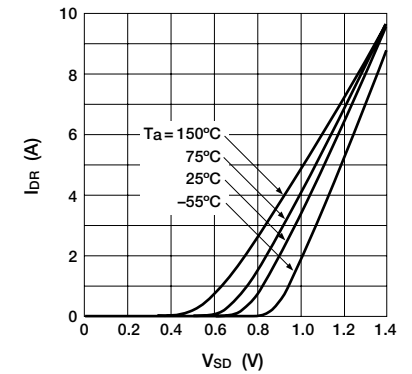

Safe Operating Area (single pulse)

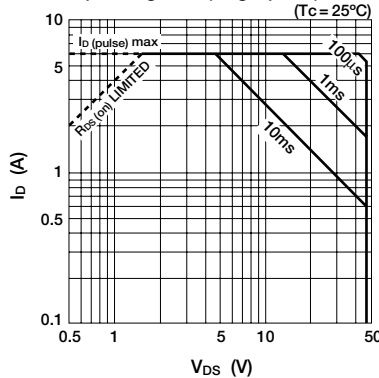

Equivalent Circuit Diagram

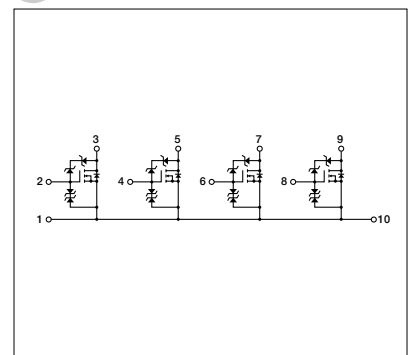

Thyristor with built-in reverse diode for HID lamp ignition TFC561D

Features

- Repetitive peak off-state voltage: $V_{DRM}=600V$
- Repetitive peak surge on-state current: $I_{TRM}=430A$
- Critical rate-of-rise of on-state current: $di/dt=1200A/\mu s$
- Gate trigger current: $I_{GT}=20mA$ max
- With built-in reverse diode

Absolute Maximum Ratings

Parameter	Symbol	Ratings	Unit	Conditions
Repetitive peak off-state voltage	V_{DRM}	600	V	$T_J = -40$ to $+125^\circ C$, $R_{GK}=1k\Omega$
Repetitive surge peak on-state current	I_{TRM}	430	A	$V_D \leq 430V$, 100kcycle, * $W_p=1.3\mu s$, $T_a=125^\circ C$
Critical rate-of-rise of on-state current	di/dt	1200	$A/\mu s$	*
Peak forward gate current	I_{FGM}	2.0	A	$f \geq 50Hz$, duty $\leq 10\%$
Peak gate power loss	P_{GM}	5.0	W	$f \geq 50Hz$, duty $\leq 10\%$
Average gate power loss	$P_{G(AV)}$	0.5	W	
Peak reverse gate voltage	V_{RGM}	5	V	$f \geq 50Hz$
Diode repetitive peak surge forward current	I_{FRM}	240	A	$V_D \leq 430V$, 100kcycle, * $W_p=1.3\mu s$, $T_a=125^\circ C$
Junction temperature	T_J	-40 to +125	$^\circ C$	
Storage temperature	T_{stg}	-40 to +125	$^\circ C$	

* The surge current for $T=10ms$ /cycle shall be applied 50 cycles successively, and an interval time shall follow to cool down the junction temperature of the device to $125^\circ C$. This process shall be repeated up to 100K cycles.

Electrical Characteristics

($T_J=25^\circ C$)

Parameter	Symbol	Ratings			Unit	Conditions
		min	typ	max		
On-state voltage	V_{TM}			1.4	V	$I_T=10A$
Gate trigger voltage	V_{GT}			1.5	V	$V_D=6V$, $R_L=10\Omega$
Gate trigger current	I_{GT}			20	mA	$V_D=6V$, $R_L=10\Omega$
Gate non-trigger voltage	V_{GD}	0.1			V	$V_D=480V$, $T_J=125^\circ C$
Holding current	I_H	2	10.0		mA	$R_{G-K}=1k\Omega$, $T_J=25^\circ C$
Off-state current (1)	$I_{DRM(1)}$			100	μA	$V_D=V_{DRM}$, $R_{G-K}=1k\Omega$, $T_J=25^\circ C$
Off-state current (2)	$I_{DRM(2)}$			1	mA	$V_D=V_{DRM}$, $R_{G-K}=1k\Omega$, $T_J=125^\circ C$
Thermal resistance	R_{th}			4.0	$^\circ C/W$	Junction to case
Diode forward voltage	V_F			1.4	V	$I_F=10A$

External Dimensions (unit: mm)

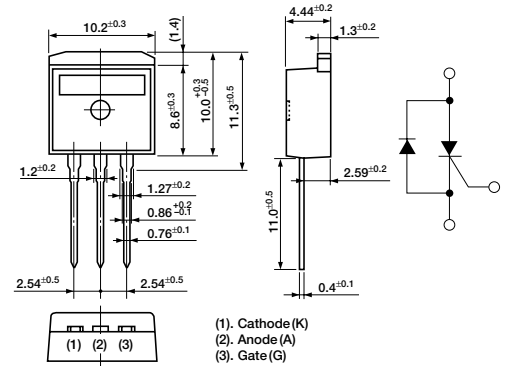

Weight: Approx. 1.5g

Measurement circuit

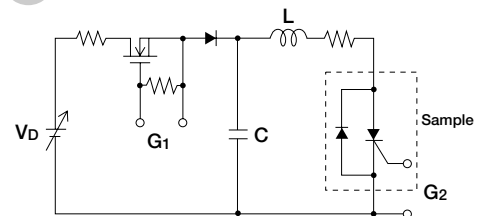

Current waveform (1 cycle)

($T_a=25^\circ C$)

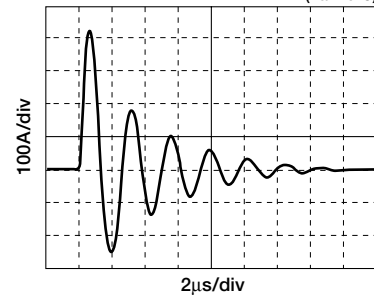

Thyristor with built-in reverse diode for HID lamp ignition TFC562D

Features

- Repetitive peak off-state voltage: $V_{DRM}=600V$
- Repetitive peak surge on-state current: $I_{TRM}=600A$
- Critical rate-of-rise of on-state current: $di/dt=1600A/\mu s$
- Gate trigger current: $I_{GT}=20mA$ max
- With built-in reverse diode

Absolute Maximum Ratings

Parameter	Symbol	Ratings	Unit	Conditions
Repetitive peak off-state voltage	V_{DRM}	600	V	$T_J = -40$ to $+125^\circ C$, $R_{GK} = 1k\Omega$
Repetitive surge peak on-state current	I_{TRM}	600	A	$T_a = 100^\circ C$, $V_D \leq 430V$, $W_p = 1.05\mu s$, $I_G = 70mA$, $di/dt = 0.5A/\mu s$, 100cycle*
Critical rate-of-rise of on-state current	di/dt	1600	A/ μs	See the examples of current waveforms
Peak forward gate current	I_{FGM}	2	A	$f \geq 50Hz$, duty $\leq 10\%$
Peak gate power loss	P_{GM}	5	W	$f \geq 50Hz$, duty $\leq 10\%$
Average gate power loss	$P_{G(AV)}$	0.5	W	
Peak reverse gate voltage	V_{RGM}	5	V	$f \geq 50Hz$
Diode repetitive peak surge forward current	I_{FRM}	460	A	$T_a = 100^\circ C$, $V_D \leq 430V$, $W_p = 1.05\mu s$, 100cycle*
Junction temperature	T_J	-40 to +125	$^\circ C$	
Storage temperature	T_{stg}	-40 to +125	$^\circ C$	

* The surge current for $T=10ms$ /cycle shall be applied 50 cycles successively, and an interval time shall follow to cool down the junction temperature of the device to $125^\circ C$. This process shall be repeated up to 100K cycles.

Electrical Characteristics

($T_J=25^\circ C$)

Parameter	Symbol	Ratings			Unit	Conditions
		min	typ	max		
On-state voltage	V_{TM}			1.4	V	$I_T = 10A$
Gate trigger voltage	V_{GT}			1.5	V	$V_D = 6V$, $R_L = 10\Omega$
Gate trigger current	$I_{GT}(1)$			20	mA	$V_D = 6V$, $R_L = 10\Omega$
Gate non-trigger voltage	V_{GD}	0.1			V	$V_D = 480V$, $T_J = 125^\circ C$
Holding current	I_H	2	5		mA	$R_{G-K} = 1k\Omega$, $T_J = 25^\circ C$
Off-state current (1)	$I_{DRM}(1)$			10	μA	$V_D = V_{DRM}$, $R_{G-K} = 1k\Omega$, $T_J = 25^\circ C$
Off-state current (2)	$I_{DRM}(2)$			1	mA	$V_D = V_{DRM}$, $R_{G-K} = 1k\Omega$, $T_J = 125^\circ C$
Thermal resistance	R_{th}			4.0	$^\circ C/W$	Junction to case, With infinite heatsink
Diode forward voltage	V_F			1.4	V	$I_F = 10A$

External Dimensions (unit: mm)

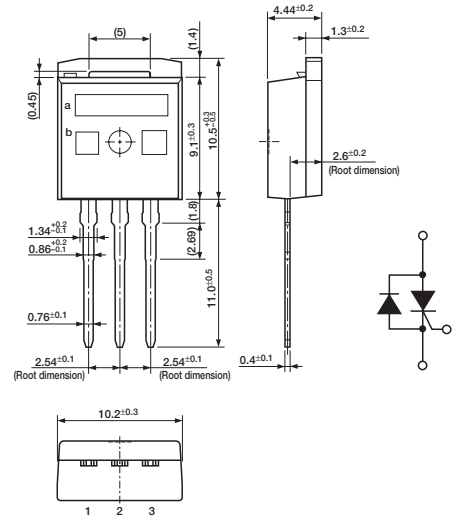

Current waveform (1cycle)

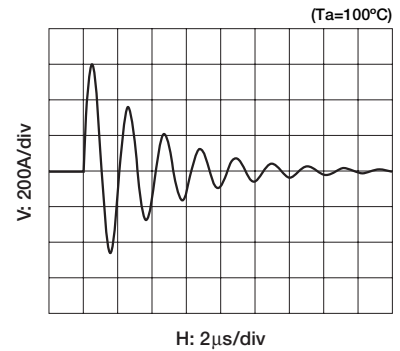

* A single cycle operation consists of a continuous impression of 50 rounds with period $T = 10ms$ followed by a rest time for the junction temperature of the element to cool down to $100^\circ C$ ($= T_a$). Repeat this cycle operation.

Rectifier Diodes for Alternators

Normal Type

Part No.	Absolute maximum ratings				Electrical Characteristics					Fig. No.	
	V _{RM} (V)	I _F (A)	I _{FSM} (A)	T _j	T _{stg}	V _F (V) max	Condition I _F (A)	I _R (mA) max	V _Z (V)		Condition I _Z (mA)
				(°C)							
SG-9CNS	200	20	200	-40 to +150		1.10	20	0.25	—	—	1
SG-9CNR											
SG-9LCNS	200	30	300	-40 to +150		1.10	30	0.25	—	—	2
SG-9LCNR											
SG-9LLCNS	200	35	350	-40 to +150		1.10	35	0.25	—	—	3
SG-9LLCNR											
SG-10LS	200	30	300	-40 to +150		1.2	100	0.25	—	—	3
SG-10LR											
SG-10LXS	150	35	350	-40 to +150		1.05	100	0.25	—	—	3
SG-10LXR											
SG-10LLS	200	40	400	-40 to +150		1.05	100	0.25	—	—	3
SG-10LLR											
SG-10LLXS	150	45	450	-40 to +150		1.0	100	0.25	—	—	3
SG-10LLXR											

Zener Type

Part No.	Absolute maximum ratings				Electrical Characteristics					Fig. No.	
	V _{RM} (V)	I _F (A)	I _{FSM} (A)	T _j	T _{stg}	V _F (V) max	Condition I _F (A)	I _R (mA) max	V _Z (V)		Condition I _Z (mA)
				(°C)							
SG-9CZS	17	20	200	-40 to +200		1.10	20	0.05	23±3	10	1
SG-9CZR											
SG-9LLCZS	17	35	350	-40 to +200		1.10	35	0.05	23±3	10	2
SG-9LLCZR											
SG-10LZ23S	17	30	300	-40 to +150		1.2	100	0.05	23±3	10	3
SG-10LZ23R											
SG-10LLZ23S	17	40	400	-40 to +150		1.05	100	0.05	23±3	10	3
SG-10LLZ23R											
SG-14LXZS	16	35	350	-40 to +200		1.15	100	0.05	22±3	100	4
SG-14LXZR											

External Dimensions (unit: mm)

Fig. 1

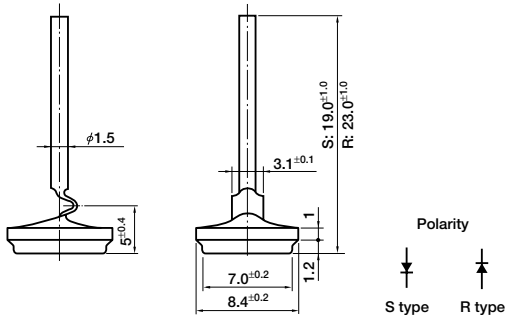

Fig. 2

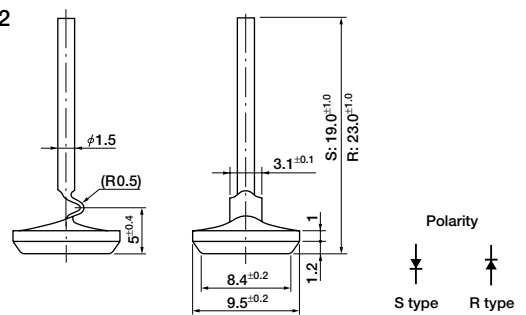

Fig. 3

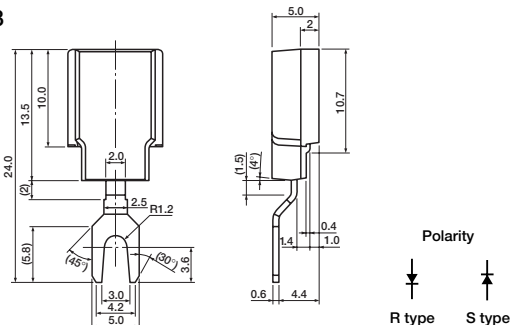
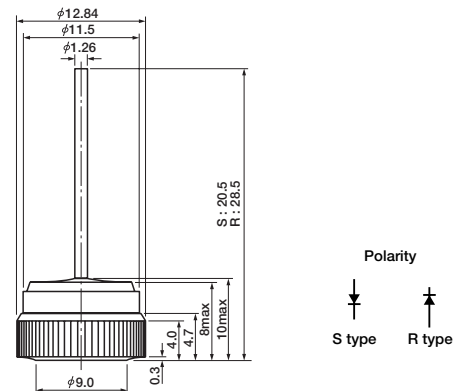

Fig. 4



High-voltage Diodes for Igniters

Part No.	Absolute Maximum Ratings					Electrical Characteristics (Ta=25°C)				Fig. No.		
	V _{RM} (kV)	I _{F(AV)} (mA) 50 Hz half-wave signal average	I _{RSM} (mA) Peak value of single shot triangular wave with 100μs half-power bandwidth	I _{RSM} (A) Peak value of 50 Hz half-wave signal	T _j	T _{stg}	V _F (V) max	Condition I _F (mA)	I _R (μA) V _R =V _{RM} max		V _Z (kV) I _R =100μA	
					(°C)							
SHV-01JN	0.5	30	30	3	-40 to +150		1	10	10	0.55 to 1.0	2	
SHV-05J	2.5	30	30	3			5			1	2.6 to 5.0	1
SHV-06JN	3.0	30	10	3			6			2	3.2 to 6.0	2

External Dimensions (unit: mm)

Fig. 1 (SHV-05J)

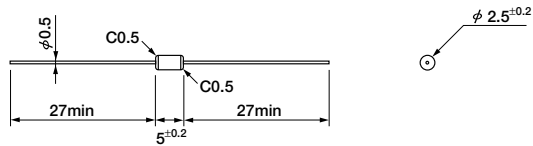
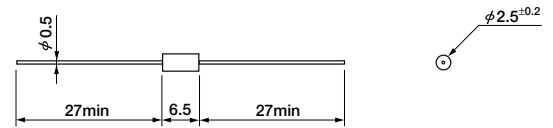

Fig. 2 (SHV-06JN)



Power Zener Diode

(Ta=25°C)

Part No.	Absolute Maximum Ratings					Electrical Characteristics			Fig. No.	Remarks
	P (W)	P _R (W)	V _{DC} (V)	I _{ZSM} (A)	T _j / T _{stg} (°C)	V _Z (V) 1mA instantaneous current	Condition I _Z (mA)	I _R V _R =V _{DC} (μA) max		
SFPZ-68	1	50 (5ms)	20	2	-40 to +150	25.0 to 31.0	1	10	1	Surface-mount type
SJPZ-K28*	1		20	2	-55 to +150	25.0 to 31.0	1	10	2	
SJPZ-E18*	1	85 (500μs)	13	—	-55 to +150	16.8 to 19.1	1	10	2	
SJPZ-E27*	1		20	—	-55 to +150	25.1 to 28.9	1	10	2	
SJPZ-E33*	1		25	—	-55 to +150	31.0 to 35.0	1	10	2	
SJPZ-E36*	1		27	—	-55 to +150	34.0 to 38.0	1	10	2	
PZ628	5	1500 (5ms)	20	65*1	-40 to +150	25.0 to 31.0	10	50	3	
SZ-10N27	5	—	22	70*1	-55 to +175	24 to 30	10	10	4	Surface-mount type
SZ-10N40*	5	—	22	40*1	-55 to +175	36 to 40	10	10	4	
SZ-10NN27	6	—	22	90*1	-55 to +175	24 to 30	10	10	4	
SZ-10NN40*	6	—	22	55*1	-55 to +175	36 to 40	10	10	4	

* under development

*1: I_{ZSM} conditions

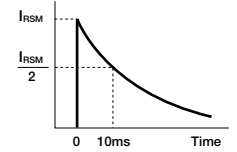

External Dimensions (unit: mm)

Fig. 1

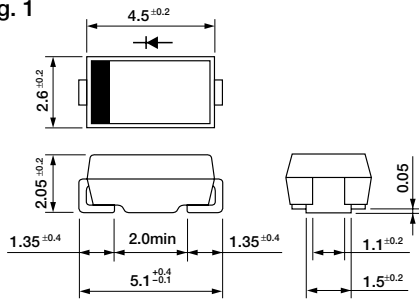

Fig. 2

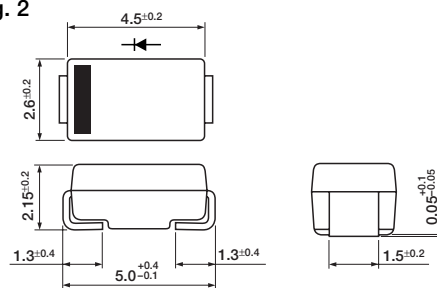

Fig. 3

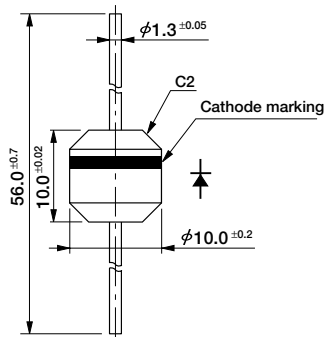
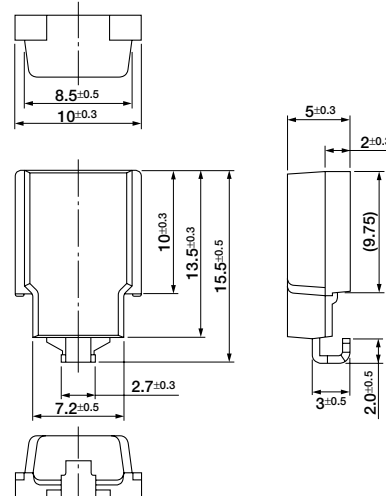

Fig. 3



General-purpose Diodes

Rectifier Diodes

■ Surface-mount

Part No.	V _{RM} (V)	I _{F(AV)} (A)	I _{FSM} (A) Peak value of 50 Hz half-wave signal	T _j (°C)	T _{stg} (°C)	V _F (V) max	I _R (μA)		I _R (H) (mA)		R _{th(j-l)} (°C/W)	Package	Weight (g)
							V _R =V _{RM} max	V _R =V _{RM} max	Condition I _F (A)	Condition T _a (°C)			
SFPM-52	200	0.9	30	-40 to +150		1.0	1.0	10	50	100	20	1	0.072
SFPM-62		1.0	45			0.98	1.0	10	50	100	20	1	0.072
SFPM-54	400	0.9	30			1.0	1.0	10	50	100	20	1	0.072
SFPM-64		1.0	45			0.98	1.0	10	50	100	20	1	0.072

Ultra Fast Recovery Rectifier Diodes

■ Surface-mount

Part No.	V _{RM} (V)	I _{F(AV)} (A)	I _{FSM} (A) Peak value of 50 Hz half-wave signal	T _j (°C)	T _{stg} (°C)	V _F (V) max	I _R (μA)		I _R (H) (mA)		t _{rr} ① (ns)	t _{rr} ② (ns)		R _{th(j-l)} (°C/W)	Package	Weight (g)	
							V _R =V _{RM} max	V _R =V _{RM} max	Condition I _F (A)	Condition T _a (°C)		Condition I _F /I _{RP} (mA)	Condition I _F /I _{RP} (mA)				
SFPL-52	200	0.9	25	-40 to +150		0.98	1.0	10	1	150 (T _j)	50	100/100	35	100/200	20	1	0.072
SFPL-62		1.0	25			0.98	2.0	10	1	150 (T _j)	50	100/100	35	100/200	20	1	0.072
MPL-102S		10.0	65			0.98	5.0	100	0.2	150	40	100/100	30	100/200	2.5	2	1.4
MP2-202S		20.0	110			0.98	10.0	200	0.4	150	50	100/100	35	100/200	2.5	2	1.4
SFPL-64	400	1.0	25			1.3	1.0	10	0.05	150	50	100/100	30	100/200	20	1	0.072

Schottky Barrier Diodes

■ Surface-mount

Part No.	V _{RM} (V)	I _{F(AV)} (A)	I _{FSM} (A) Peak value of 50 Hz half-wave signal	T _j (°C)	T _{stg} (°C)	V _F (V) max	I _R (μA)		I _R (H) (mA)		R _{th(j-l)} (°C/W)	Package	Weight (g)
							V _R =V _{RM} max	V _R =V _{RM} max	Condition I _F (A)	Condition T _a (°C)			
SFPJ-53*	30	1.0	30	-40 to +150		0.45	1.0	1.0	35	150	20	1	0.072
SFPJ-63	30	2.0	40			0.45	2.0	2.0	70	150	20	1	0.072
SFPJ-73	30	3.0	50			0.45	3.0	3.0	100	150	20	1	0.072
SFPB-54	40	1.0	30			0.55	1.0	1	35	150	20	1	0.072
SFPB-64	40	2.0	60			0.55	2.0	5	70	150	20	1	0.072
SFPE-64	40	2.0	40			0.6	2.0	0.2	70	150	20	1	0.072
SFPB-74	40	3.0	60			0.5	2.0	5	100	150	20	1	0.072
SFPB-56	60	0.7	10			0.62	0.7	1	30	150	20	1	0.072
SFPW-56	60	1.5	25			0.7	1.5	1	70	150	20	1	0.072
SFPB-66	60	2.0	25			0.69	2.0	1	55	150	20	1	0.072
SFPB-76	60	2.0	40			0.62	2.0	2	70	150	20	1	0.072
SFPB-59	90	0.7	10			0.81	0.7	1	30	150	20	1	0.072
SFPB-69	90	1.5	40			0.81	1.5	2	55	150	20	1	0.072

* under development

External Dimensions (unit: mm)

1: (Surface-mount SFP)

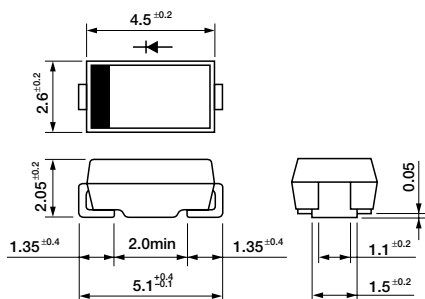

2: (TO-220S)

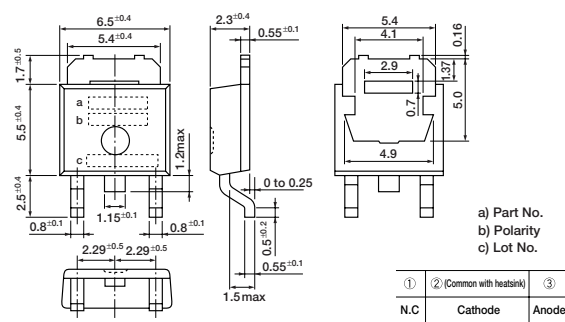

General-purpose Diodes - Taping Specifications

Taping Specifications

Taping Name	Taping Dimensions (mm)	Packaging Dimensions (mm) and Markings	Packaging Quantity
V A suffix "V" is added to Part No. for tape packaging.	<p>Emboss taping</p> <p>(1) The right side of the tape is the cathode viewing in the unfold direction. (2) The product is inserted into the case with the installed electrode on the lower side. (3) A leader tape 150 to 200mm long is provided on the unfolding edge. (4) A space of at least 10 pitches equivalent is provided on either end of the tape. (5) Taping with reversed diode polarity is available on request (taping name VL).</p>	<p>Reel</p>	1,800 pcs. per reel

Power Surface-mount - Taping Specifications

Taping Name	Taping Dimensions (mm)	Packaging Dimensions (mm) and Markings	Packaging Quantity
VL A suffix "VL" is added to Part No. for tape packaging.			3,000 pcs. per reel
VR A suffix "VR" is added to Part No. for tape packaging.			3,000 pcs. per reel

High-voltage diodes for ignition - Taping Specifications

Taping Name	Taping Dimensions (mm)	Packaging Dimensions (mm) and Markings	Packaging Quantity
V1 A suffix "V1" is added to Part No. for tape packaging.	<p>Axial taping</p>		5,000 pcs. per reel

Power Zener Surface-mount - Taping Specifications

Taping Name	Taping Dimensions (mm)	Packaging Dimensions (mm) and Markings	Packaging Quantity
<p>VL</p> <p>A suffix "VL" is added to Part No. for tape packaging.</p>			<p>750 pcs. per reel</p>
<p>VR</p> <p>A suffix "VR" is added to Part No. for tape packaging.</p>		<p>The label showing the product name, quantity and production lot is attached to the reel.</p>	<p>750 pcs. per reel</p>

3

LEDs

3-1. Uni-Color LED Lamps	134
3-2. Bi-Color LED Lamps	137
3-3. Surface Mount LEDs	138
3-4. Infrared LEDs	140
3-5. Ultraviolet LEDs	141
3-6. Multi-chip Modules	142

General-purpose LEDs

Uni-Color LED Lamps

Absolute Maximum Ratings

(Ta=25°C)

Parameter	Unit	Ratings						Conditions
		GaP	GaAsP	GaAlAs	AlGaInP	InGaN	GaN	
P _D	mW	75			120			
I _F	mA	30						
ΔI _F	mA/°C	-0.45						Above 25°C
I _{FP}	mA	100				70		f=1kHz, tw=100μs
V _R	V	3			5			
Top	°C	-30 to +85				-30 to +80		
Tstg	°C	-30 to +100						

Outline	Emitting color	Part No.	Lens color	Electro-optical characteristics (Ta=25°C)							Contact mount	Fig. No.
				V _F (V)		I _v (mcd)	Condition I _F (mA)	Peak wavelength λ _p (nm)	Dominant wavelength λ _p (nm)	Chip material		
				typ	max	typ		typ	typ			
5φ Round	Deep red	SEL1110R	Diffused red	2.0	2.5	2.8	5	700	625	GaP	×	
		SEL1110W	Diffused white			2.8					×	
		SEL1110S	Tinted red			4.5					×	
	High-intensity red	SEL1610W	Diffused white	1.75	2.2	250	20	660	642	GaAlAs	×	
		SEL1610C	Clear			300					×	
	Red	SEL1210R	Diffused red	1.9	2.5	26	20	630	620	GaAsP	×	
		SEL1210S	Tinted red			75					×	
	Amber	SEL1810D	Diffused orange	1.9	2.5	18	10	610	605	GaAsP	×	
		SEL1810A	Tinted orange			37					×	
	Orange	SEL1910D	Diffused orange	1.9	2.5	14	10	587	590	GaAsP	×	
		SEL1910A	Tinted orange			25					×	
	Yellow	SEL1710Y	Diffused yellow	2.0	2.5	22	10	570	571	GaP	×	
		SEL1710K	Tinted yellow			65					×	
	Green	SEL1410G	Diffused green	2.0	2.5	32	20	560	567	GaP	×	
		SEL1410E	Tinted green			84					×	
	Pure green	SEL1510C	Clear	2.0	2.5	50	20	555	559	GaP	×	
	Red	SEL1210RM	Diffused red	1.9	2.5	36	20	630	620	GaAsP	×	
		SEL1210SM	Tinted red			75					×	
	Amber	SEL1810DM	Diffused orange	1.9	2.5	18	10	610	605	GaAsP	×	
		SEL1810AM	Tinted orange			37					×	
	Orange	SEL1910DM	Diffused orange	1.9	2.5	19	10	587	590	GaAsP	×	
		SEL1910AM	Tinted orange			34					×	
	Yellow	SEL1710KM	Tinted yellow	2.0	2.5	65	10	570	571	GaP	×	
	Green	SEL1410GM	Diffused green	2.0	2.5	30	20	560	567	GaP	×	
		SEL1410EM	Tinted green			84					×	
	Pure green	SEL1510CM	Clear	2.0	2.5	50	20	555	559	GaP	×	
	Ultra high-intensity red	SELU1210CXM	Clear	2.0	2.5	280	20	635	625	AlGaInP	×	
	Ultra high-intensity orange	SELU1910CXM-S	Clear	2.0	2.5	450	20	591	589	AlGaInP	×	
	Ultra high-intensity pure green	SELU1D10CXM	Clear	3.3	4.0	2000	20	525	530	InGaN	×	
	Ultra high-intensity blue	SELU1E10CXM	Clear	3.3	4.0	600	20	468	470	InGaN	×	
Ultra high-intensity blue	SELS1E10CXM-M	Clear	3.7	4.2	1000	20	468	470	InGaN	×		
Ultra high-intensity red	SELU1250CM	Clear	2.0	2.5	900	20	635	625	AlGaInP	○		
Red	SEL1250SM	Tinted red	1.9	2.5	75	20	630	620	GaAsP	○		
	SEL1250RM	Diffused red			48					○		
Amber	SEL1850AM	Tinted orange	1.9	2.5	90	20	610	605	GaAsP	○		
	SEL1850DM	Diffused orange			60					○		
Orange	SEL1950KM	Tinted orange	1.9	2.5	96	20	587	590	GaAsP	○		
Green	SEL1450EKM	Tinted green	2.0	2.5	190	20	560	567	GaP	○		
	SEL1450GM-YG	Diffused green			120					○		
Pure green	SEL1550CM	Clear	2.0	2.5	72	20	555	559	GaP	○		
Ultra high-intensity pure green	SELU1D50CM	Clear	3.3	4.0	6000	20	525	530	InGaN	×		
Ultra high-intensity blue	SELU1E50CM	Clear	3.3	4.0	1850	20	468	470	InGaN	×		
High-intensity red	SEL1615C	Clear	1.75	2.2	170	20	660	642	GaAlAs	×		
4.6×5.6φ Egg-shaped	Ultra high-intensity red	SELU1253CEMKT	Clear	2.0	2.5	200	20	635	625	AlGaInP	×	
	Green	SEL1453CEMKT	Tinted green	2.0	2.5	140	20	560	567	GaP	×	
4φ Round	Deep red	SEL4110S	Tinted red	2.0	2.5	2.4	5	700	625	GaP	×	
		SEL4110R	Diffused red			1.7					×	
	Red	SEL4210S	Tinted red	1.9	2.5	30	20	630	620	GaAsP	×	
		SEL4210R	Diffused red			17					×	
	Amber	SEL4810A	Tinted orange	1.9	2.5	20	10	610	605	GaAsP	×	
		SEL4810D	Diffused orange			15					×	
	Orange	SEL4910A	Tinted orange	1.9	2.5	26	10	587	590	GaAsP	×	
		SEL4910D	Diffused orange			16					×	
	Yellow	SEL4710K	Tinted yellow	2.0	2.5	36	10	570	571	GaP	×	
		SEL4710Y	Diffused yellow			14					×	

Uni-Color LED Lamps

Outline	Emitting color	Part No.	Lens color	Electro-optical characteristics (Ta=25°C)						Chip material	Contact mount	Fig. No.
				VF (V)		Iv (mcd)	Condition If (mA)	Peak wavelength λp (nm)	Dominant wavelength λp (nm)			
				typ	max							
4φ Round	Green	SEL4410E	Tinted green	2.0	2.5	87	20	560	567	GaP	×	7
		SEL4410G	Diffused green			34					×	
	Ultra high-intensity green	SELU4410CKT-S	Clear	2.1	2.5	170	20	560	562	AλGalnP	×	
	Pure green	SEL4510C	Clear	2.0	2.5	45	20	555	559	GaP	×	
	Deep red	SEL4114S	Tinted red	2.0	2.5	3.8	10	700	625	GaP	○	
		SEL4114R	Diffused red			2.8					○	
	Red	SEL4214S	Tinted red	1.9	2.5	40	20	630	620	GaAsP	○	
		SEL4214R	Diffused red			24					○	
	Amber	SEL4814A	Tinted orange	1.9	2.5	20	10	610	605	GaAsP	○	
		SEL4814D	Diffused orange			15					○	
	Orange	SEL4914A	Tinted orange	1.9	2.5	26	10	587	590	GaAsP	○	
		SEL4914D	Diffused orange			11					○	
Yellow	SEL4714K	Tinted yellow	2.0	2.5	38	10	570	571	GaP	○		
	SEL4714Y	Diffused yellow			27					○		
Green	SEL4414E	Tinted green	2.0	2.5	69	20	560	567	GaP	○		
	SEL4414G	Diffused green			48					○		
Pure green	SEL4514C	Clear	2.0	2.5	26	20	555	559	GaP	○		
3φ Round	Deep red	SEL6110S	Tinted red	2.0	2.5	3.9	10	700	625	GaP	○	9
		SEL6110R	Diffused red			2.6					○	
	Red	SEL6210S	Tinted red	1.9	2.5	41	20	630	620	GaAsP	○	
		SEL6210R	Diffused red			18					○	
	Amber	SEL6810A	Tinted orange	1.9	2.5	22	10	610	605	GaAsP	○	
		SEL6810D	Diffused orange			9.6					○	
	Ultra high-intensity orange	SELU6910C-S	Clear	2.0	2.5	550	20	591	589	AλGalnP	○	
	Orange	SEL6910A	Tinted orange	1.9	2.5	22	10	587	590	GaAsP	○	
		SEL6910D	Diffused orange			11					○	
	Yellow	SEL6710K	Tinted yellow	2.0	2.5	37	10	570	571	GaP	○	
		SEL6710Y	Diffused yellow			11					○	
	Green	SEL6410E	Tinted green	2.0	2.5	90	20	560	567	GaP	○	
SEL6410G		Diffused green	30			○						
Pure green	SEL6510C	Clear	2.0	2.5	42	20	555	559	GaP	○		
	SEL6510G	Diffused green			9.6					○		
Blue	SEL6E10C	Clear	4.0	4.8	60	20	430	466	GaN	○		
3φ Round	Ultra high-intensity deep red	SELU6614C-S	Clear	2.0	2.5	150	20	650	639	AλGalnP	○	10
		SELU6614W-S	Diffused white			90					○	
	Ultra high-intensity red	SELU6214C	Clear	2.0	2.5	180	20	635	625	AλGalnP	○	
	Red	SEL6214S	Tinted red	1.9	2.5	18	20	630	620	GaAsP	○	
	Amber	SEL6814A	Tinted orange	1.9	2.5	9.0	10	610	605	GaAsP	○	
	Ultra high-intensity light amber	SELS6B14C	Clear	2.	2.5	120	20	600	596	AλGalnP	○	
	Ultra high-intensity orange	SELU6914C-S	Clear	2.0	2.5	180	20	591	589	AλGalnP	○	
	Orange	SEL6914A	Tinted orange	1.9	2.5	8.0	10	587	590	GaAsP	○	
		SEL6914W	Diffused white			5.0					○	
	Ultra high-intensity yellow	SELU6714C	Clear	2.1	2.5	60	20	572	571	AλGalnP	○	
	Yellow	SEL6714K	Tinted yellow	2.0	2.5	66	20	570	571	GaP	○	
		SEL6714W	Diffused white			30					○	
Green	SEL6414E	Tinted green	2.0	2.5	42	20	560	567	GaP	○		
Ultra high-intensity green	SELU6414G-S	Diffused green	2.1	2.5	30	20	560	562	AλGalnP	○		
Deep green	SEL6414E-TG	Tinted green	2.0	2.5	18	20	558	564	GaP	○		
Pure green	SEL6514C	Clear	2.0	2.5	12	20	555	559	GaP	○		
Ultra high-intensity pure green	SELS6D14C	Clear	3.3	4.0	300	20	518	525	InGaP	○		
Ultra high-intensity blue	SELS6E14C-M	Clear	3.7	4.2	70	20	468	470	InGaN	○		
Red	SEL6215S	Tinted red	1.9	2.5	45	20	630	620	GaAsP	○		
Orange	SEL6915A	Tinted orange	1.9	2.5	60	20	587	590	GaAsP	○		
Yellow	SEL6715C	Clear	2.0	2.5	90	20	570	571	GaP	○		
Green	SEL6415E	Tinted green	2.0	2.5	81	20	560	567	GaP	○		
Pure green	SEL6515C	Clear	2.0	2.5	44	20	555	559	GaP	○		
Deep red	SEL2110S	Tinted red	2.0	2.5	4	10	700	625	GaP	×	11	
	SEL2110R	Diffused red			1.8					×		
	SEL2110W	Diffused white			1.8					×		
High-intensity red	SEL2610C	Clear	1.75	2.2	60	20	660	642	GaAlAs	×		
Ultra high-intensity deep red	SELU2610C-S	Clear	2.0	2.5	300	20	650	639	AλGalnP	×		
Red	SEL2210S	Tinted red	1.9	2.5	40	20	630	620	GaAsP	×	12	
	SEL2210R	Diffused red			15					×		
	SEL2210W	Diffused white			15					×		
Amber	SEL2810A	Tinted orange	1.9	2.5	22	10	610	605	GaAsP	×		
	SEL2810D	Diffused orange			9.0					×		
Ultra high-intensity light amber	SELU2B10A-S	Tinted orange	2.0	2.5	300	20	598	595	AλGalnP	×		

General-purpose LEDs

Uni-Color LED Lamps

Outline	Emitting color	Part No.	Lens color	Electro-optical characteristics (Ta=25°C)						Chip material	Contact mount	Fig. No.
				VF (V)		IV (mcd)	Condition IF (mA)	Peak wavelength λp (nm)	Dominant wavelength λp (nm)			
				typ	max							
3φ Round	Orange	SEL2910A	Tinted orange	1.9	2.5	16	10	587	590	GaAsP	×	
		SEL2910D	Diffused orange			8.0					×	
	Ultra high-intensity yellow	SELU2710C	Clear	2.1	2.5	270	20	572	571	AlGaInP	×	
	Yellow	SEL2710K	Tinted yellow	2.0	2.5	40	10	570	571	GaP	×	
		SEL2710Y	Diffused yellow			14					×	
	Green	SEL2410E	Tinted green	2.0	2.5	77	20	560	567	GaP	×	
		SEL2410G	Diffused green			20					×	
	Pure green	SEL2510C	Clear	2.0	2.5	43	20	555	559	GaP	×	
		SEL2510G	Diffused green			8.2					×	
	Ultra high-intensity pure green	SELU2D10C	Clear	3.3	4.0	1200	20	525	530	InGaN	×	
	Ultra high-intensity blue	SELU2E10C	Clear	3.3	4.0	400	20	468	470	InGaN	×	
	Blue	SEL2E10C	Clear	4.0	4.8	60	20	430	466	GaN	×	
	Ultra high-intensity red	SELU2215R-S	Diffused red	2.0	2.5	380	20	632	624	AlGaInP	×	
	Red	SEL2215S	Tinted red	1.9	2.5	45	20	630	620	GaAsP	×	
		SEL2215R	Diffused red			38					×	
	Amber	SEL2815A	Tinted orange	1.9	2.5	80	10	610	605	GaAsP	×	
		SEL2815D	Diffused orange			60					×	
	Orange	SEL2915A	Tinted orange	1.9	2.5	81	10	587	590	GaAsP	×	
		SEL2915D	Diffused orange			53					×	
	Yellow	SEL2715K	Tinted yellow	2.0	2.5	130	10	570	571	GaP	×	
SEL2715Y		Diffused yellow	110			×						
Green	SEL2415E	Tinted green	2.0	2.5	110	20	560	567	GaP	×		
	SEL2415G	Diffused green			72					×		
Pure green	SEL2515C	Clear	2.0	2.5	52	20	555	559	GaP	×		
Inverted-cone typ for surface illumination	Red	SEL1213C	Tinted red	1.9	2.5	7.0	20	630	620	GaAsP	×	
	Amber	SEL1813A	Tinted orange	1.9	2.5	8.0	20	610	605	GaAsP	×	
	Orange	SEL1913K	Tinted light orange	1.9	2.5	8.0	20	587	590	GaAsP	×	
	Yellow	SEL1713K	Tinted yellow	2.0	2.5	15	20	570	571	GaP	×	
	Green	SEL1413E	Tinted green	2.0	2.5	12	20	560	567	GaP	×	
	Pure green	SEL1513E	Tinted light green	2.0	2.5	5.0	20	555	559	GaP	×	
	Ultra high-intensity red	SELU6213C-S	Clear	2.0	2.5	30	20	632	624	AlGaInP	○	
	Ultra high-intensity light amber	SELS6B13W	Diffused white	2.0	2.5	60	20	600	596	AlGaInP	○	
	Green	SEL6413E	Tinted green	2.0	2.5	14	20	560	567	GaP	○	
	Deep green	SEL6413E-TG	Tinted green	2.0	2.5	6	20	558	564	GaP	○	
Pure green	SEL6513C	Clear	2.0	2.5	5.0	20	555	559	GaP	○		
5mm Pitch lead rectangular	High-intensity red	SEL2613CS-S	Tinted light red	1.75	2.2	20	20	660	642	GaAlAs	×	
	Red	SEL2213C	Tinted red	1.9	2.5	7.0	20	630	620	GaAsP	×	
	Amber	SEL2813A	Tinted orange	1.9	2.5	8.0	20	610	605	GaAsP	×	
	Orange	SEL2913K	Tinted orange	1.9	2.5	8.0	20	587	590	GaAsP	×	
	Yellow	SEL2713K	Tinted yellow	2.0	2.5	17	20	570	571	GaP	×	
	Green	SEL2413E	Tinted green	2.0	2.5	14	20	560	567	GaP	×	
		SEL2413G	Diffused green			12					×	
	Pure green	SEL2513E	Tinted green	2.0	2.5	5.0	20	555	559	GaP	×	
	5mm Pitch lead bow-shaped	Ultra high-intensity red	SELS5223C	Clear	2.0	2.5	100	20	635	625	AlGaInP	○
		Red	SEL5223S	Tinted red	1.9	2.5	25	20	630	620	GaAsP	○
Amber		SEL5823A	Tinted orange	1.9	2.5	35	20	610	605	GaAsP	○	
Ultra high-intensity light amber		SELS5B23C	Clear	2.0	2.5	135	20	600	596	AlGaInP	○	
Ultra high-intensity orange		SELS5923C	Clear	2.0	2.5	145	20	591	589	AlGaInP	○	
Orange		SEL5923A	Tinted orange	1.9	2.5	35	20	587	590	GaAsP	○	
Ultra high-intensity yellow		SELU5723C	Clear	2.1	2.5	155	20	572	571	AlGaInP	○	
Yellow		SEL5723C	Clear	2.0	2.5	60	20	570	571	GaP	○	
Green		SEL5423E	Tinted green	2.0	2.5	40	20	560	567	GaP	○	
Pure green		SEL5523C	Clear	2.0	2.5	13	20	555	559	GaP	○	
Ultra high-intensity blue	SELU5E23C	Clear	3.3	4.0	180	20	468	470	InGaN	○		
Blue	SEL5E23C	Clear	4.0	4.8	20	20	430	466	GaN	○		

Bi-Color LED Lamps

Absolute Maximum Ratings

(Ta=25°C)

Parameter	Unit	Ratings					Conditions	
		GaP	GaAsP	GaAlAs	AlGaInP	InGaN		
P _D	mW	75					120	Also applies to simultaneous lighting
I _F	mA	30						
ΔI _F	mA/°C	-0.45						Above 25°C
I _{FP}	mA	100						f=1kHz, tw=100μs
V _R	V	3			5			
Top	°C	-30 to +85						
Tstg	°C	-30 to +100						

Outline	Part No.	Emitting color	Lens color	Electro-optical characteristics (Ta=25°C)							Common	Contact mount	Fig. No.
				V _F (V)		I _V (mcd)	Condition I _F (mA)	Peak wavelength λ _p (nm)	Dominant wavelength λ _p (nm)	Chip material			
				typ	max								
5φ Round	SML11516C	Deep red	Clear	2.0	2.5	15	20	700	625	GaP	Cathode	×	19
		Pure green		2.0	2.5	50	20	555	559	GaP			
	SML1516W	Deep red	Diffused white	2.0	2.5	6.0	20	700	625	GaP	Cathode	×	
		Pure green		2.0	2.5	20	20	555	559	GaP			
	SML1216C	Red	Clear	1.9	2.5	65	20	630	620	GaAsP	Cathode	×	
		Green		2.0	2.5	90	20	560	567	GaP			
	SML1216W	Red	Diffused white	1.9	2.5	60	20	630	620	GaAsP	Cathode	×	
		Green		2.0	2.5	60	20	560	567	GaP			
	SML1816W	Amber	Diffused white	1.9	2.5	50	20	610	605	GaAsP	Cathode	×	
		Green		2.0	2.5	60	20	560	567	GaP			
	SML19416W	Orange	Diffused white	1.9	2.5	45	20	587	590	GaAsP	Cathode	×	
		Green		2.0	2.5	60	20	560	567	GaP			
	SMLU12E16C	Ultra high-intensity red	Clear	2.0	2.5	500	20	632	624	AlGaInP	Cathode	×	
		Ultra high-intensity blue		3.3	4.0	400	20	468	470	InGaN			
SMLU12E16W	Ultra high-intensity red	Diffused white	2.0	2.5	250	20	632	624	AlGaInP	Cathode	×		
	Ultra high-intensity blue		3.3	4.0	150	20	468	470	InGaN				
SMLU12D16W	Ultra high-intensity red	Diffused white	2.0	2.5	250	20	632	624	AlGaInP	Cathode	×		
	Ultra high-intensity pure green		3.3	4.0	700	20	525	530	InGaN				
SMLU18D16C	Ultra high-intensity amber	Clear	2.0	2.5	800	20	611	605	AlGaInP	Cathode	×		
	Ultra high-intensity pure green		3.3	4.0	2000	20	525	530	InGaN				
SMLU18D16W-S	Ultra high-intensity amber	Diffused white	2.0	2.5	300	20	611	605	AlGaInP	Cathode	×		
	Ultra high-intensity pure green		3.3	4.0	500	20	525	530	InGaN				
3.3×6 Rectangular	SML72420C	Red	Clear	1.9	2.5	15	20	630	620	AGaAsP	Cathode	○	20
		Green		2.0	2.5	20	20	560	567	GaP			
	SML78420C	Amber	Clear	1.9	2.5	10	20	610	605	GaAsP	Cathode	○	
		Green		2.0	2.5	20	20	560	567	GaP			
SML79420C	Orange	Clear	1.9	2.5	10	20	587	590	GaAsP	Cathode	○		
	Green		2.0	2.5	20	20	560	567	GaP				
3.3×6 Bow-shaped	SML72423C	Red	Clear	1.9	2.5	25	20	630	620	GaAsP	Cathode	○	21
		Green		2.0	2.5	35	20	560	567	GaP			
	SML72923C	Red	Clear	1.9	2.5	25	20	630	620	GaAsP	Cathode	○	
		Orange		1.9	2.5	25	20	587	590	GaAsP			
	SML78423C	Amber	Clear	1.9	2.5	25	20	610	605	GaAsP	Cathode	○	
		Green		2.0	2.5	35	20	560	567	GaP			
	SML79423C	Orange	Clear	1.9	2.5	25	20	587	590	GaAsP	Cathode	○	
		Green		2.0	2.5	35	20	560	657	GaP			
	SMLS79723C	Ultra high-intensity orange	Clear	2.0	2.5	150	20	590	590	AlGaInP	Cathode	○	
		Yellow		2.0	2.5	40	20	570	571	GaP			
SMLU72423C-S	Ultra high-intensity red	Clear	2.0	2.5	120	20	635	625	AlGaInP	Cathode	○		
	Ultra high-intensity green		2.2	2.5	30	20	560	567	AlGaInP				
SMLU79423C-S	Ultra high-intensity orange	Clear	2.0	2.5	150	20	590	590	AlGaInP	Cathode	○		
	Ultra high-intensity green		2.2	2.5	30	20	560	567	AlGaInP				

Surface Mount LEDs

Absolute Maximum Ratings

(Ta=25°C)

Parameter	Unit	Ratings						Conditions
		GaP	GaAsP	GaAlAs	AlGalnP	InGaN	GaN	
I _F	mA	30						
ΔI _F	mA/°C	-0.45						Above 25°C
I _{FP}	mA	70						f=1kHz, tw=100μs
V _R	V	4			5			
Top	°C	-30 to +85			-25 to +85			
Tstg	°C	-30 to +100						

Uni-Color Surface Mount LEDs

Outline	Emitting color	Part No.	Lens color	Electro-optical characteristics (Ta=25°C)							Chip material	Fig. No.
				V _F (V)		I _v (mcd)	Condition I _F (mA)	Peak wavelength λ _p (nm)	Dominant wavelength λ _p (nm)			
				typ	max	typ		typ	typ			
Side view (flat lens type)	Red	SEC4201C	Clear	1.9	2.5	10	20	630	620	GaAsP	22	
	Amber	SEC4801C	Clear	1.9	2.5	16	20	610	605	GaAsP		
	Orange	SEC4901C	Clear	1.9	2.5	13	20	587	590	GaAsP		
	Yellow	SEC4701C	Clear	2.0	2.5	25	20	570	571	GaP		
	Green	SEC4401C	Clear	2.0	2.5	22	20	560	567	GaP		
	Deep green	SEC4401E-TG	Tinted green	2.0	2.5	11	20	558	564	GaP		
	Pure green	SEC4501C	Clear	2.0	2.5	8.0	20	555	559	GaP		
Side view (inner lens type)	Ultra high-intensity blue	SECU4E01C	Clear	3.3	4.0	50	20	468	470	InGaN	23	
	Red	SEC4203C	Clear	1.9	2.5	15	20	630	620	GaAsP		
	Amber	SEC4803C	Clear	1.9	2.5	20	20	610	605	GaAsP		
	Orange	SEC4903C	Clear	1.9	2.5	15	20	587	590	GaAsP		
	Yellow	SEC4703C	Clear	2.0	2.5	35	20	570	571	GaP		
	Green	SEC4403C	Clear	2.0	2.5	33	20	560	567	GaP		
	Deep green	SEC4403E-TG	Tinted green	2.0	2.5	15	20	558	564	GaP		
3×1.5 (flat lens type)	Pure green	SEC4503C	Clear	2.0	2.5	10	20	555	559	GaP	24	
	Deep red	SEC1101C	Clear	2.0	2.5	1.5	20	700	625	GaP		
	High-intensity red	SEC1601C	Clear	1.7	2.2	25	20	660	642	GaAlAs		
	Red	SEC1201C	Clear	1.9	2.5	10	20	630	620	GaAsP		
	Amber	SEC1801C	Clear	1.9	2.5	16	20	610	605	GaAsP		
	Orange	SEC1901C	Clear	1.9	2.5	13	20	587	590	GaAsP		
	Yellow	SEC1701C-YG	Clear	2.0	2.5	25	20	570	571	GaP		
	Green	SEC1401C	Clear	2.0	2.5	22	20	560	567	GaP		
	Deep green	SEC1401E-TG	Tinted green	2.0	2.5	11	20	558	564	GaP		
	Pure green	SEC1501C	Clear	2.0	2.5	8.0	20	555	559	GaP		
3×1.5 (inner lens type)	Ultra high-intensity pure green	SECU1D01C	Clear	3.3	4.0	150	20	525	525	InGaN	25	
	Ultra high-intensity blue	SECU1E01C	Clear	3.3	4.0	50	20	470	468	InGaN		
	Blue	SEC1E01C	Clear	3.9	4.8	6.0	20	430	466	GaN		
	High-intensity red	SEC1603C	Clear	1.7	2.2	35	20	660	642	GaAlAs		
	Ultra high-intensity red	SECS1203C	Clear	1.9	2.5	100	20	635	625	AlGalnP		
	Red	SEC1203C	Clear	1.9	2.5	15	20	630	620	GaAsP		
	Ultra high-intensity amber	SECS1803C	Clear	1.9	2.5	10	3	615	607	AlGalnP		
	Amber	SEC1803C	Clear	1.9	2.5	20	20	610	605	GaAsP		
	Ultra high-intensity orange	SECS1903C	Clear	1.9	2.5	70	20	590	590	AlGalnP		
	Orange	SEC1903C	Clear	1.9	2.5	15	20	587	590	GaAsP		
	Yellow	SEC1703C	Clear	2.0	2.5	35	20	570	571	GaP		
	Green	SEC1403C	Clear	2.0	2.5	33	20	560	567	GaP		
Deep green	SEC1403E-TG	Tinted green	2.0	2.5	15	20	558	564	GaP			
Pure green	SEC1503C	Clear	2.0	2.5	10	20	555	559	GaP			

Surface Mount LEDs

Uni-color / Bi-color Surface Mount LEDs with two elements

Outline	Part No.	Emitting color	Lens color	Electro-optical characteristics (Ta=25°C)							Fig. No.
				VF (V)		Iv (mcd)	Condition If (mA)	Peak wavelength λp (nm)	Dominant wavelength λp (nm)	Chip material	
				typ	max						
3×2.5 (flat lens type)	SEC2422C	Red	Clear	1.9	2.5	10	20	630	620	GaAsP	26
		Green		2.0	2.5	20	20	560	567	GaP	
	SEC2442C	Green	Clear	2.0	2.5	20	20	560	567	GaP	
		Green		2.0	2.5	20	20	560	567	GaP	
	SEC2462C	High-intensity red	Clear	1.7	2.2	20	20	660	642	GaAlAs	
		Green		2.0	2.5	20	20	560	567	GaP	
	SEC2492C	Orange	Clear	1.9	2.5	10	20	587	590	GaAsP	
		Green		2.0	2.5	20	20	560	567	GaP	
	SEC2552C	Pure green	Clear	2.0	2.5	5.0	20	555	559	GaP	
		Pure green		2.0	2.5	5.0	20	555	559	GaP	
	SEC2592C	Orange	Clear	1.9	2.5	10	20	587	590	GaAsP	
		Pure green		2.0	2.5	5.0	20	555	559	GaP	
SEC2762C-YG	High-intensity red	Clear	1.7	2.2	20	20	660	642	GaAlAs		
	Yellow		2.0	2.5	20	20	570	571	GaP		
3×2.5 (inner lens type)	SEC2484C	Amber	Clear	1.9	2.5	20	20	610	605	GaAsP	27
		Green		2.0	2.5	30	20	560	567	GaP	
	SEC2554C	Pure green	Clear	2.0	2.5	10	20	555	559	GaP	
		Pure green		2.0	2.5	10	20	555	559	GaP	
	SEC2494C	Orange	Clear	1.9	2.5	20	20	587	590	GaAsP	
		Green		2.0	2.5	30	20	560	567	GaP	
	SEC2764C	High-intensity red	Clear	1.7	2.2	50	20	660	642	GaAlAs	
		Yellow		2.0	2.5	50	20	570	571	GaP	
	SEC2774C	Yellow	Clear	2.0	2.5	50	20	570	571	GaP	
		Yellow		2.0	2.5	50	20	570	571	GaP	

Infrared LEDs

Absolute Maximum Ratings

(Ta=25°C)

Parameter	Unit	Ratings	Conditions
I _F	mA	150	
ΔI _F	mA/°C	-1.33	Above 25°C
I _{FP}	mA	1000	f=1kHz, tw=10μs
V _R	V	5	
Top	°C	-30 to +85	
Tstg	°C	-30 to +100	

Infrared LEDs

Outline	Part No.	Lens color	Electro-optical characteristics (Ta=25°C)						Contact mount	Fig. No.
			V _F (V)		Radiant intensity I _e (mW/sr)	Condition	Peak wavelength λ _p (nm)	Chip material		
			typ	max						
5φ Round	SID1010CM	Clear	1.3	1.5	130	(Constant voltage) V _{CC} =3V, R=2.2Ω	940	GaAs	×	28
	SID1K10CM	Clear	1.3	1.5	200		940	GaAs	×	
	SID1010CXM	Clear	1.3	1.5	80		940	GaAs	×	
	SID1K10CXM	Clear	1.3	1.5	110		940	GaAs	×	
	SID1050CM	Clear	1.3	1.5	250		940	GaAs	○	29
	SID303C	Clear	1.3	1.5	80		940	GaAs	×	30
	SID313BP	Transparent light purple	1.3	1.5	130		940	GaAs	×	
	SID1003BQ	Transparent light navy blue	1.3	1.5	180		940	GaAs	×	
	SID307BR	Transparent dark navy blue	1.3	1.5	200		940	GaAs	×	
	SID1G307C	Clear	1.5	1.8	50		850	GaAs	×	
SID1G313C	Clear	1.5	1.8	50	850	GaAs	×			
3φ Round	SID2010C	Clear	1.3	1.5	7	I _F =50mA	940	GaAs	×	31
	SID2K10C	Clear	1.3	1.5	14		940	GaAs	×	
3×1.5 (inner lens type) chip	SEC1G03C	Clear	1.5	1.8	3		850	GaAs	—	25

Ultraviolet LEDs

Absolute Maximum Ratings

(Ta=25°C)

Parameter	Unit	Ratings	Conditions
I _F	mA	30	
ΔI _F	mA/°C	-0.45	Above 25°C
I _{FP}	mA	100	f=1kHz, tw=10μs
I _R	mA	100	Max. rating of built-in Zener diode
Top	°C	-30 to +85	
Tstg	°C	-30 to +100	

Ultraviolet Surface Mount LEDs

Outline	Part No.	Lens color	Electro-optical characteristics (Ta=25°C)							Chip material	Fig. No.
			V _F (V)		I _v (mcd)	Condition I _F (mA)	Peak wavelength λ _p (nm)	Electrostatic withstand voltage (V)			
			typ	max				typ	typ		
2.8×3.5	SECU1V0AC	Clear	3.7	4.0	2.2	20	385	4000	100pF, 1.5kΩ	InGaN	32

Multi-chip LED Module (under development)

Absolute Maximum Ratings

(Per element Ta=25°C)

Parameter	Unit	Ratings	Conditions
I _F	mA	40	With an infinite heatsink mounted
ΔI _F	mA/°C	-0.25	
I _{FP}	mA	100	f=1kHz, tw=10μs
V _R	V	5	
T _{opr}	°C	-30 to +85	
T _{stg}	°C	-30 to +100	

Part No.	Colors compliant with JIS-Z9112	Color temperature [°K] 20mA	Total flux [lm] 20mA	Chromaticity x, y 20mA	Fig. No.
SEP8WD4001	Cool white	6400	30	0.32, 0.33	33
SEP8WN4001	Natural white	5000	30	0.34, 0.35	
SEP8WE4001	White	4200	30	0.37, 0.37	
SEP8WW4001	Warm white	3450	25	0.41, 0.38	
SEP8WL4001	Light bulb	2875	25	0.44, 0.41	

General-purpose LEDs - External Dimensions

(Unit: mm)

Fig.1

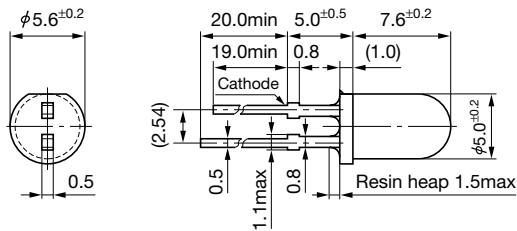

Fig.6

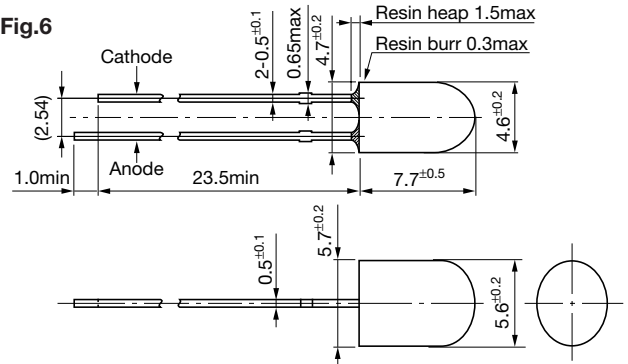

Fig.2

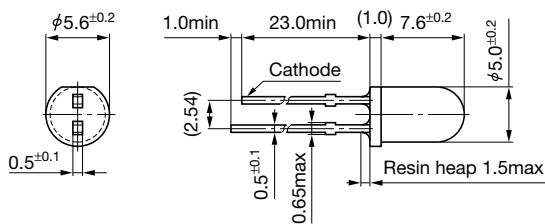

Fig.7

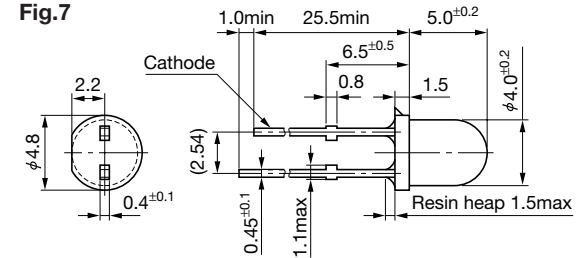

Fig.3

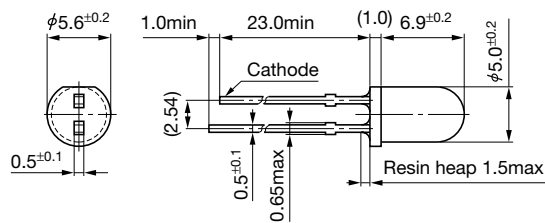

Fig.8

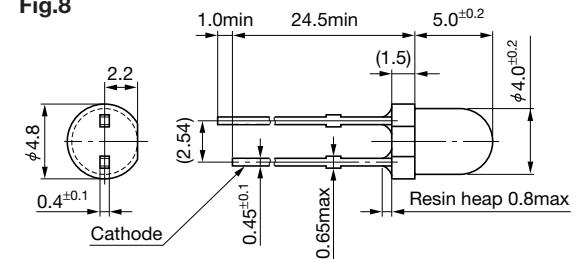

Fig.4

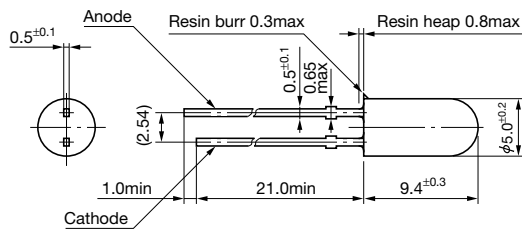

Fig.9

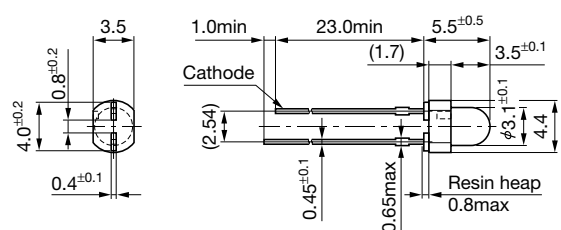

Fig.5

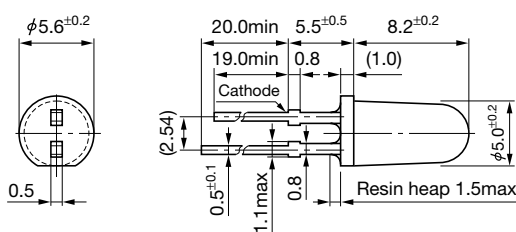
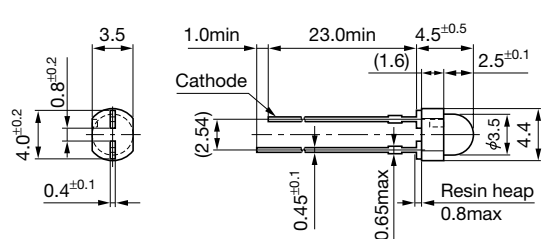
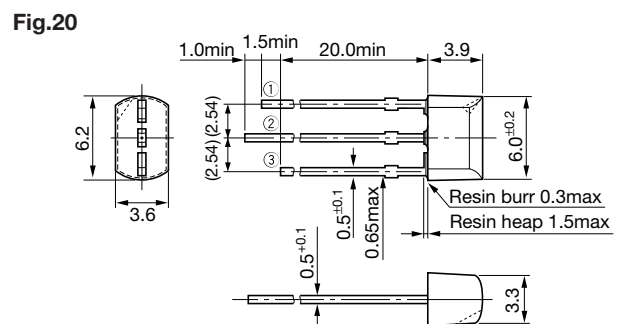
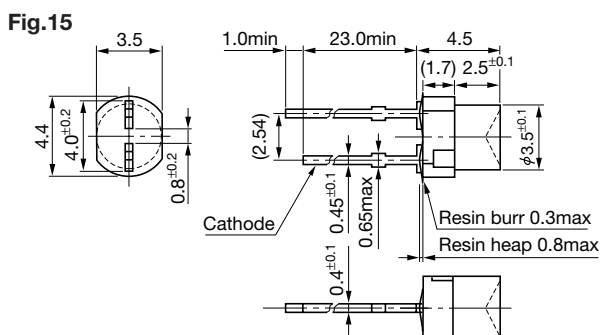
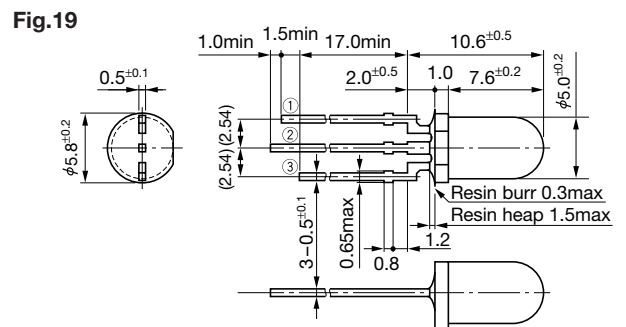
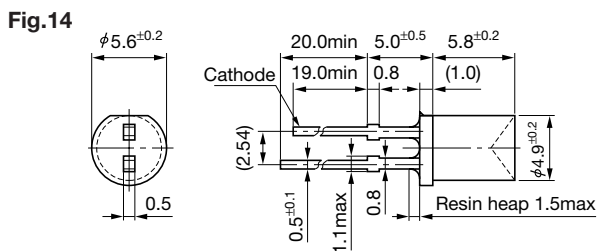
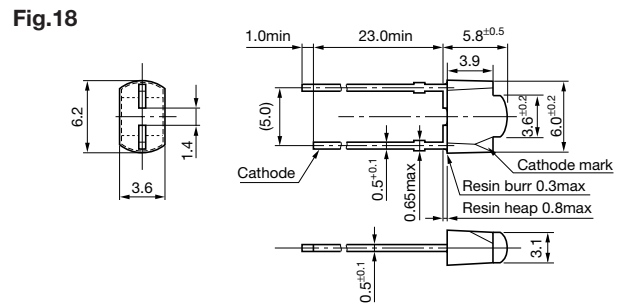
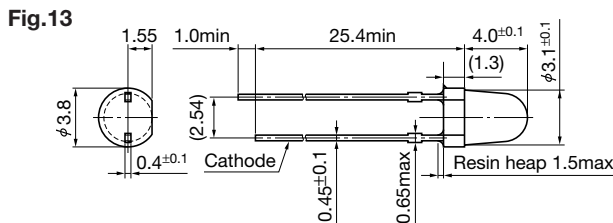
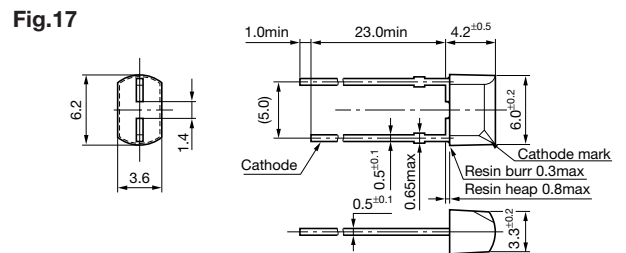
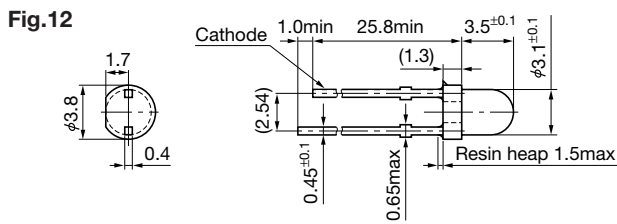
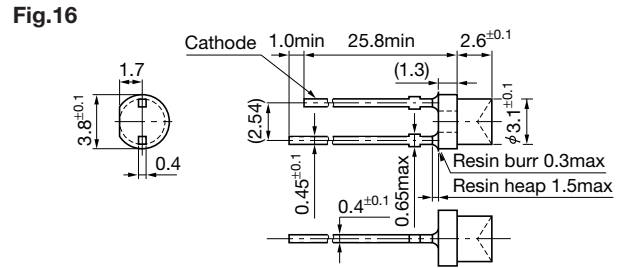
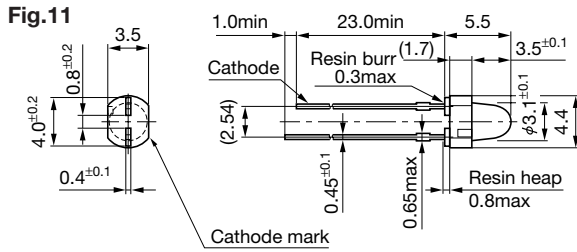

Fig.10



General-purpose LEDs - External Dimensions

(Unit: mm)



General-purpose LEDs - External Dimensions

(Unit: mm)

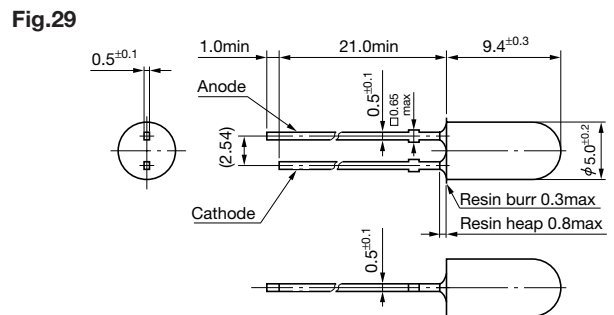
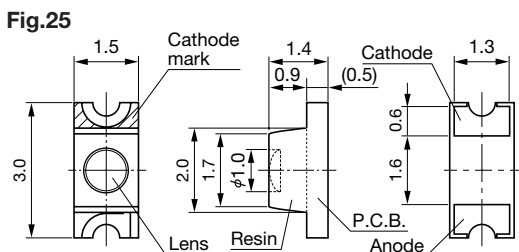
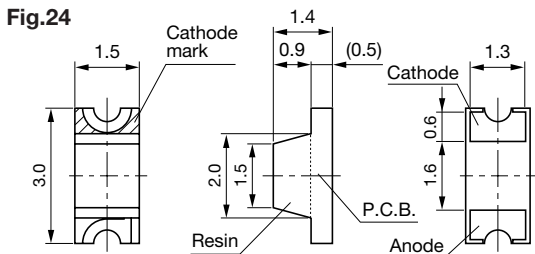
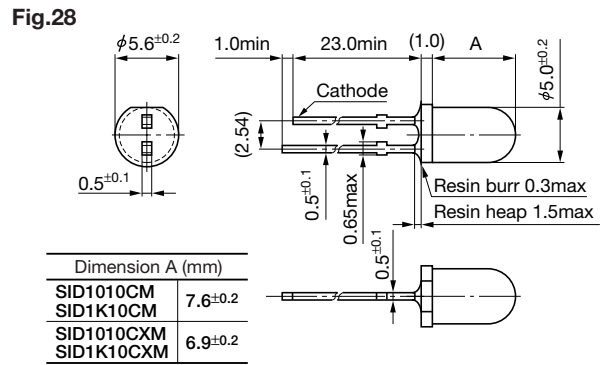
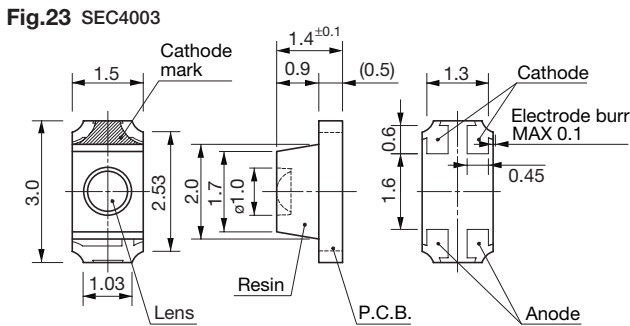
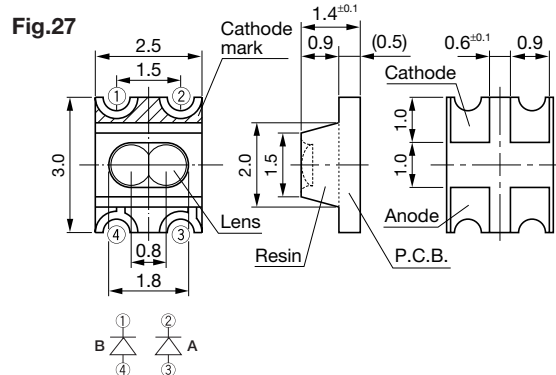
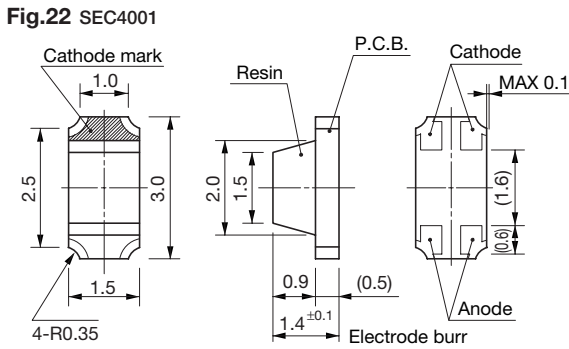
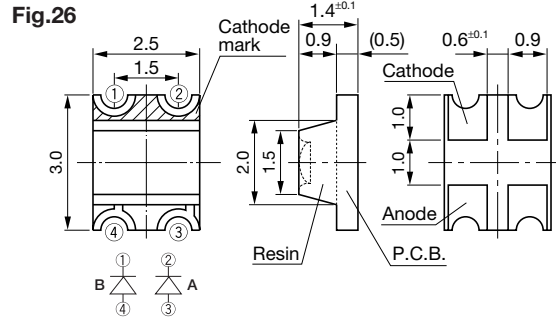
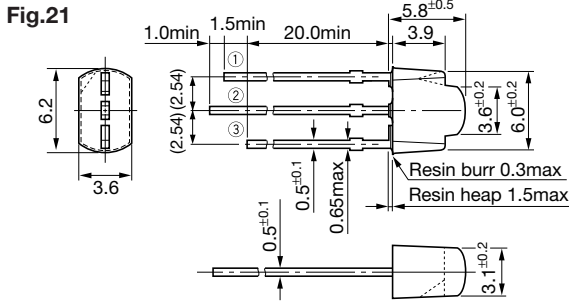

Part Number Index in Alphanumeric Order

Part No.	Description	Page
2SA1488/A	Power transistor	80
2SA1567	Power transistor	81
2SA1568	Power transistor	82
2SA1908	Power transistor	83
2SB1622	Power transistor	84
2SC3852	Power transistor	85
2SC4024	Power transistor	86
2SC4065	Power transistor	87
2SC4153	Power transistor	88
2SD2141	Power transistor	89
2SD2382	Power transistor	90
2SD2633	Power transistor	91
2SK3710	MOS FET	108
2SK3711	MOS FET	109
2SK3724	MOS FET	110
2SK3800	MOS FET	111
2SK3801	MOS FET	112
2SK3803	MOS FET	113
2SK3851	MOS FET	114
FKV460S	MOS FET	115
FKV660S	MOS FET	116
FP812	Power transistor	92
MN611S	Power transistor	93
MN638S	Power transistor	94
MP2-202S	Ultrafast Recovery Diode (Surface Mount)	130
MPL-102S	Ultrafast Recovery Diode (Surface Mount)	130
PZ628	Power Zener Diode (Surface Mount)	129
SDA03	Power transistor Array (Surface Mount)	96
SDA04	Power transistor Array (Surface Mount)	97
SDC09	Power transistor Array (Surface Mount)	98
SDH04	High-side Power Switch IC	24
SDK06	MOS FET Array (Surface mount)	117
SDK08	MOS FET Array (Surface mount)	118
SDK09	MOS FET Array (Surface mount)	119
SEC1101C	3 x 1.5 Surface Mount LED	138
SEC1201C	3 x 1.5 Surface Mount LED	138
SEC1203C	3 x 1.5 Surface Mount Inner Lens TypeLED	138
SEC1401C	3 x 1.5 Surface Mount LED	138
SEC1401E-TG	3 x 1.5 Surface Mount LED	138
SEC1403C	3 x 1.5 Surface Mount Inner Lens TypeLED	138
SEC1403E-TG	3 x 1.5 Surface Mount Inner Lens TypeLED	138
SEC1501C	3 x 1.5 Surface Mount LED	138
SEC1503C	3 x 1.5 Surface Mount Inner Lens TypeLED	138
SEC1601C	3 x 1.5 Surface Mount LED	138
SEC1603C	3 x 1.5 Surface Mount Inner Lens TypeLED	138
SEC1701C-YG	3 x 1.5 Surface Mount LED	138
SEC1703C	3 x 1.5 Surface Mount Inner Lens TypeLED	138
SEC1801C	3 x 1.5 Surface Mount LED	138
SEC1803C	3 x 1.5 Surface Mount Inner Lens TypeLED	138
SEC1901C	3 x 1.5 Surface Mount LED	138
SEC1903C	3 x 1.5 Surface Mount Inner Lens TypeLED	138
SEC1E01C	3 x 1.5 Surface Mount LED	138
SEC1G03C	3 x 1.5 Infrared Surface Mount Inner Lens Type LED	140

Part No.	Description	Page
SEC2422C	3 x 2.5 Surface Mount 2-Chip LED	139
SEC2442C	3 x 2.5 Surface Mount 2-Chip LED	139
SEC2462C	3 x 2.5 Surface Mount 2-Chip LED	139
SEC2484C	3 x 2.5 Surface Mount Inner Lens Type 2-Chip LED	139
SEC2492C	3 x 2.5 Surface Mount 2-Chip LED	139
SEC2494C	3 x 2.5 Surface Mount Inner Lens Type 2-Chip LED	139
SEC2552C	3 x 2.5 Surface Mount 2-Chip LED	139
SEC2554C	3 x 2.5 Surface Mount Inner Lens Type 2-Chip LED	139
SEC2592C	3 x 2.5 Surface Mount 2-Chip LED	139
SEC2762C-YG	3 x 2.5 Surface Mount 2-Chip LED	139
SEC2764C	3 x 2.5 Surface Mount Inner Lens Type 2-Chip LED	139
SEC2774C	3 x 2.5 Surface Mount Inner Lens Type 2-Chip LED	139
SEC4201C	Side-view Surface Mount LED	138
SEC4203C	Side-view Surface Mount Inner Lens TypeLED	138
SEC4401C	Side-view Surface Mount LED	138
SEC4401E-TG	Side-view Surface Mount LED	138
SEC4403C	Side-view Surface Mount Inner Lens TypeLED	138
SEC4403E-TG	Side-view Surface Mount Inner Lens TypeLED	138
SEC4501C	Side-view Surface Mount LED	138
SEC4503C	Side-view Surface Mount Inner Lens TypeLED	138
SEC4701C	Side-view Surface Mount LED	138
SEC4703C	Side-view Surface Mount Inner Lens TypeLED	138
SEC4801C	Side-view Surface Mount LED	138
SEC4803C	Side-view Surface Mount Inner Lens TypeLED	138
SEC4901C	Side-view Surface Mount LED	138
SEC4903C	Side-view Surface Mount Inner Lens TypeLED	138
SECS1203C	3 x 1.5 Surface Mount Inner Lens TypeLED	138
SECS1803C	3 x 1.5 Surface Mount Inner Lens TypeLED	138
SECS1903C	3 x 1.5 Surface Mount Inner Lens TypeLED	138
SECU1D01C	3 x 1.5 Surface Mount LED	138
SECU1E01C	3 x 1.5 Surface Mount LED	138
SECU1V0AC	2.8 x 3.5 Ultraviolet Surface Mount LED	141
SECU4E01C	Side-view Surface Mount LED	138
SEL1110R	5ø Round Standard LED (With Stopper)	134
SEL1110S	5ø Round Standard LED (With Stopper)	134
SEL1110W	5ø Round Standard LED (With Stopper)	134
SEL1210R	5ø Round Standard LED (With Stopper)	134
SEL1210RM	5ø Round Standard LED	134
SEL1210S	5ø Round Standard LED (With Stopper)	134
SEL1210SM	5ø Round Standard LED	134
SEL1213C	5ø Inverted-cone LED for Surface illumination	136
SEL1250RM	5ø Round Narrow-directivity LED, Direct mount supported	134
SEL1250SM	5ø Round Narrow-directivity LED, Direct mount supported	134
SEL1410E	5ø Round Standard LED (With Stopper)	134
SEL1410EM	5ø Round Standard LED	134
SEL1410G	5ø Round Standard LED (With Stopper)	134
SEL1410GM	5ø Round Standard LED	134
SEL1413E	5ø Inverted-cone LED for Surface illumination	136
SEL1450EKM	5ø Round Narrow-directivity LED, Direct mount supported	134
SEL1450GM-YG	5ø Round Narrow-directivity LED, Direct mount supported	134
SEL1453CEMKT	4.6 x 5.6ø Egg-shaped LED	134
SEL1510C	5ø Round Standard LED (With Stopper)	134
SEL1510CM	5ø Round Standard LED	134

Part No.	Description	Page
SEL1513E	5ø Inverted-cone LED for Surface illumination	136
SEL1550CM	5ø Round Narrow-directivity LED, Direct mount supported	134
SEL1610C	5ø Round Standard LED (With Stopper)	134
SEL1610W	5ø Round Standard LED (With Stopper)	134
SEL1615C	5ø Round Narrow-directivity LED	134
SEL1710K	5ø Round Standard LED (With Stopper)	134
SEL1710KM	5ø Round Standard LED	134
SEL1710Y	5ø Round Standard LED (With Stopper)	134
SEL1713K	5ø Inverted-cone LED for Surface illumination	136
SEL1810A	5ø Round Standard LED (With Stopper)	134
SEL1810AM	5ø Round Standard LED	134
SEL1810D	5ø Round Standard LED (With Stopper)	134
SEL1810DM	5ø Round Standard LED	134
SEL1813A	5ø Inverted-cone LED for Surface illumination	136
SEL1850AM	5ø Round Narrow-directivity LED, Direct mount supported	134
SEL1850DM	5ø Round Narrow-directivity LED, Direct mount supported	134
SEL1910A	5ø Round Standard LED (With Stopper)	134
SEL1910AM	5ø Round Standard LED	134
SEL1910D	5ø Round Standard LED (With Stopper)	134
SEL1910DM	5ø Round Standard LED	134
SEL1913K	5ø Inverted-cone LED for Surface illumination	136
SEL1950KM	5ø Round Narrow-directivity LED, Direct mount supported	134
SEL2110R	3ø Round Type LED	135
SEL2110S	3ø Round Type LED	135
SEL2110W	3ø Round Type LED	135
SEL2210R	3ø Round Type LED	135
SEL2210S	3ø Round Type LED	135
SEL2210W	3ø Round Type LED	135
SEL2213C	3ø Inverted-cone LED for Surface illumination	136
SEL2215R	3ø Round Type Narrow-directivity LED	136
SEL2215S	3ø Round Type Narrow-directivity LED	136
SEL2410E	3ø Round Type LED	136
SEL2410G	3ø Round Type LED	136
SEL2413E	3ø Inverted-cone LED for Surface illumination	136
SEL2413G	3ø Inverted-cone LED for Surface illumination	136
SEL2415E	3ø Round Type Narrow-directivity LED	136
SEL2415G	3ø Round Type Narrow-directivity LED	136
SEL2510C	3ø Round Type LED	136
SEL2510G	3ø Round Type LED	136
SEL2513E	3ø Inverted-cone LED for Surface illumination	136
SEL2515C	3ø Round Type Narrow-directivity LED	136
SEL2610C	3ø Round Type LED	135
SEL2613CS-S	3ø Inverted-cone LED for Surface illumination	136
SEL2710K	3ø Round Type LED	136
SEL2710Y	3ø Round Type LED	136
SEL2713K	3ø Inverted-cone LED for Surface illumination	136
SEL2715K	3ø Round Type Narrow-directivity LED	136
SEL2715Y	3ø Round Type Narrow-directivity LED	136
SEL2810A	3ø Round Type LED	135
SEL2810D	3ø Round Type LED	135
SEL2813A	3ø Inverted-cone LED for Surface illumination	136
SEL2815A	3ø Round Type Narrow-directivity LED	136
SEL2815D	3ø Round Type Narrow-directivity LED	136

Part Number Index in Alphanumeric Order

Part No.	Description	Page	Part No.	Description	Page	Part No.	Description	Page
SEL2910A	3ø Round Type LED	136	SEL6410G	3ø Round Type LED, Direct mount supported	135	SELU5B20C	5mm Pitch Lead Rectangular LED, Direct mount supported	136
SEL2910D	3ø Round Type LED	136	SEL6413E	3ø Inverted-cone LED for Surface illumination, Direct mount supported	136	SELU5E23C	5mm Pitch Lead Bow-shaped LED, Direct mount supported	136
SEL2913K	3ø Inverted-cone LED for Surface illumination	136	SEL6413E-TG	3ø Inverted-cone LED for Surface illumination, Direct mount supported	136	SELU6213C-S	3ø Inverted-cone LED for Surface illumination, Direct mount supported	136
SEL2915A	3ø Round Type Narrow-directivity LED	136	SEL6414E	3ø Round Type Wide-directivity LED, Direct mount supported	135	SELU6214C	3ø Round Type Wide-directivity LED, Direct mount supported	135
SEL2915D	3ø Round Type Narrow-directivity LED	136	SEL6414E-TG	3ø Round Type Wide-directivity LED, Direct mount supported	135	SELU6414G-S	3ø Round Type Wide-directivity LED, Direct mount supported	135
SEL2E10C	3ø Round Type LED	136	SEL6415E	3ø Round Type Narrow-directivity LED, Direct mount supported	135	SELU6614C-S	3ø Round Type Wide-directivity LED, Direct mount supported	135
SEL4110R	4ø Round Type LED	134	SEL6510C	3ø Round Type LED, Direct mount supported	135	SELU6614W-S	3ø Round Type Wide-directivity LED, Direct mount supported	135
SEL4110S	4ø Round Type LED	134	SEL6510G	3ø Round Type LED, Direct mount supported	135	SELU6714C	3ø Round Type Wide-directivity LED, Direct mount supported	135
SEL4114R	4ø Round Type Wide-directivity LED, Direct mount supported	135	SEL6513C	3ø Inverted-cone LED for Surface illumination, Direct mount supported	136	SELU6910C-S	3ø Round Type LED, Direct mount supported	135
SEL4114S	4ø Round Type Wide-directivity LED, Direct mount supported	135	SEL6514C	3ø Round Type Wide-directivity LED, Direct mount supported	135	SELU6914C-S	3ø Round Type Wide-directivity LED, Direct mount supported	135
SEL4210R	4ø Round Type LED	134	SEL6515C	3ø Round Type Narrow-directivity LED, Direct mount supported	135	SEP8WD4001	Multi-chip LED Module	142
SEL4210S	4ø Round Type LED	134	SEL6710K	3ø Round Type LED, Direct mount supported	135	SEP8WE4001	Multi-chip LED Module	142
SEL4214R	4ø Round Type Wide-directivity LED, Direct mount supported	135	SEL6710Y	3ø Round Type LED, Direct mount supported	135	SEP8WL4001	Multi-chip LED Module	142
SEL4214S	4ø Round Type Wide-directivity LED, Direct mount supported	135	SEL6714K	3ø Round Type Wide-directivity LED, Direct mount supported	135	SEP8WN4001	Multi-chip LED Module	142
SEL4410E	4ø Round Type LED	135	SEL6714W	3ø Round Type Wide-directivity LED, Direct mount supported	135	SEP8WW4001	Multi-chip LED Module	142
SEL4410G	4ø Round Type LED	135	SEL6715C	3ø Round Type Narrow-directivity LED, Direct mount supported	135	SFPB-54	Schottky Barrier Diode(Surface Mount)	130
SEL4414E	4ø Round Type Wide-directivity LED, Direct mount supported	135	SEL6810A	3ø Round Type LED, Direct mount supported	135	SFPB-56	Schottky Barrier Diode(Surface Mount)	130
SEL4414G	4ø Round Type Wide-directivity LED, Direct mount supported	135	SEL6810D	3ø Round Type LED, Direct mount supported	135	SFPB-59	Schottky Barrier Diode(Surface Mount)	130
SEL4510C	4ø Round Type LED	135	SEL6814A	3ø Round Type Wide-directivity LED, Direct mount supported	135	SFPB-64	Schottky Barrier Diode(Surface Mount)	130
SEL4514C	4ø Round Type Wide-directivity LED, Direct mount supported	135	SEL6910A	3ø Round Type LED, Direct mount supported	135	SFPB-66	Schottky Barrier Diode(Surface Mount)	130
SEL4710K	4ø Round Type LED	134	SEL6910D	3ø Round Type LED, Direct mount supported	135	SFPB-69	Schottky Barrier Diode(Surface Mount)	130
SEL4710Y	4ø Round Type LED	134	SEL6914A	3ø Round Type Wide-directivity LED, Direct mount supported	135	SFPB-74	Schottky Barrier Diode(Surface Mount)	130
SEL4714K	4ø Round Type Wide-directivity LED, Direct mount supported	135	SEL6914W	3ø Round Type Wide-directivity LED, Direct mount supported	135	SFPB-76	Schottky Barrier Diode(Surface Mount)	130
SEL4714Y	4ø Round Type Wide-directivity LED, Direct mount supported	135	SEL6915A	3ø Round Type Narrow-directivity LED, Direct mount supported	135	SFPE-64	Schottky Barrier Diode(Surface Mount)	130
SEL4810A	4ø Round Type LED	134	SEL6E10C	3ø Round Type LED, Direct mount supported	135	SFPJ-53	Schottky Barrier Diode(Surface Mount)	130
SEL4810D	4ø Round Type LED	134	SELS1E10CXM-M	5ø Round Wide-directivity LED	134	SFPJ-63	Schottky Barrier Diode(Surface Mount)	130
SEL4814A	4ø Round Type Wide-directivity LED, Direct mount supported	135	SELS5223C	5mm Pitch Lead Bow-shaped LED, Direct mount supported	136	SFPJ-73	Schottky Barrier Diode(Surface Mount)	130
SEL4814D	4ø Round Type Wide-directivity LED, Direct mount supported	135	SELS5923C	5mm Pitch Lead Bow-shaped LED, Direct mount supported	136	SFPL-52	Ultrafast Recovery Diode(Surface Mount)	130
SEL4910A	4ø Round Type LED	134	SELS5B23C	5mm Pitch Lead Bow-shaped LED, Direct mount supported	136	SFPL-62	Ultrafast Recovery Diode(Surface Mount)	130
SEL4910D	4ø Round Type LED	134	SELS6B13W	3ø Inverted-cone LED for Surface illumination, Direct mount supported	136	SFPL-64	Ultrafast Recovery Diode(Surface Mount)	130
SEL4914A	4ø Round Type Wide-directivity LED, Direct mount supported	135	SELS6B14C	3ø Round Type Wide-directivity LED, Direct mount supported	135	SFPM-52	Rectifier Diode(Surface Mount)	130
SEL4914D	4ø Round Type Wide-directivity LED, Direct mount supported	135	SELS6D14C	3ø Round Type Wide-directivity LED, Direct mount supported	135	SFPM-54	Rectifier Diode(Surface Mount)	130
SEL5220S	5mm Pitch Lead Rectangular LED, Direct mount supported	136	SELS6E14C-M	3ø Round Type Wide-directivity LED, Direct mount supported	135	SFPM-62	Rectifier Diode(Surface Mount)	130
SEL5223S	5mm Pitch Lead Bow-shaped LED, Direct mount supported	136	SELU1210CXM	5ø Round Wide-directivity LED	134	SFPM-64	Rectifier Diode(Surface Mount)	130
SEL5420E	5mm Pitch Lead Rectangular LED, Direct mount supported	136	SELU1250CM	5ø Round Narrow-directivity LED, Direct mount supported	134	SFPW-56	Schottky Barrier Diode(Surface Mount)	130
SEL5423E	5mm Pitch Lead Bow-shaped LED, Direct mount supported	136	SELU1253CMKT	4.6 x 5.6ø Egg-shaped LED	134	SFPZ-68	Power Zener Diode	129
SEL5520C	5mm Pitch Lead Rectangular LED, Direct mount supported	136	SELU1910CXM-S	5ø Round Wide-directivity LED	134	SG-9CNR	Rectifier Diode for Alternator	127
SEL5523C	5mm Pitch Lead Bow-shaped LED, Direct mount supported	136	SELU1D10CXM	5ø Round Wide-directivity LED	134	SG-9CNS	Rectifier Diode for Alternator	127
SEL5620C	5mm Pitch Lead Rectangular LED, Direct mount supported	136	SELU1D50CM	5ø Round Narrow-directivity LED, Direct mount supported	134	SG-9CZR	Rectifier Diode for Alternator	127
SEL5723C	5mm Pitch Lead Bow-shaped LED, Direct mount supported	136	SELU1E10CXM	5ø Round Wide-directivity LED	134	SG-9CZS	Rectifier Diode for Alternator	127
SEL5820A	5mm Pitch Lead Rectangular LED, Direct mount supported	136	SELU1E50CM	5ø Round Narrow-directivity LED, Direct mount supported	134	SG-9LCNR	Rectifier Diode for Alternator	127
SEL5823A	5mm Pitch Lead Bow-shaped LED, Direct mount supported	136	SELU2215R-S	3ø Round Type Narrow-directivity LED	136	SG-9LCNS	Rectifier Diode for Alternator	127
SEL5920A	5mm Pitch Lead Rectangular LED, Direct mount supported	136	SELU2610C-S	3ø Round Type LED	135	SG-9LLCNR	Rectifier Diode for Alternator	127
SEL5923A	5mm Pitch Lead Bow-shaped LED, Direct mount supported	136	SELU2710C	3ø Round Type LED	136	SG-9LLCNS	Rectifier Diode for Alternator	127
SEL5E20C	5mm Pitch Lead Rectangular LED, Direct mount supported	136	SELU2B10A-S	3ø Round Type LED	135	SG-9LLCZR	Rectifier Diode for Alternator	127
SEL5E23C	5mm Pitch Lead Bow-shaped LED, Direct mount supported	136	SELU2D10C	3ø Round Type LED	136	SG-9LLCZS	Rectifier Diode for Alternator	127
SEL6110R	3ø Round Type LED, Direct mount supported	135	SELU2E10C	3ø Round Type LED	136	SG-10LLR	Rectifier Diode for Alternator	127
SEL6110S	3ø Round Type LED, Direct mount supported	135	SELU4410CKT-S	4ø Round Type LED	135	SG-10LLS	Rectifier Diode for Alternator	127
SEL6210R	3ø Round Type LED, Direct mount supported	135	SELU5220C-S	5mm Pitch Lead Rectangular LED, Direct mount supported	136	SG-10LLXR	Rectifier Diode for Alternator	127
SEL6210S	3ø Round Type LED, Direct mount supported	135	SELU5620S-S	5mm Pitch Lead Rectangular LED, Direct mount supported	136	SG-10LLXS	Rectifier Diode for Alternator	127
SEL6214S	3ø Round Type Wide-directivity LED, Direct mount supported	135	SELU5720C	5mm Pitch Lead Rectangular LED, Direct mount supported	136	SG-10LLZ3R	Rectifier Diode for Alternator	127
SEL6215S	3ø Round Type Narrow-directivity LED, Direct mount supported	135	SELU5723C	5mm Pitch Lead Bow-shaped LED, Direct mount supported	136	SG-10LLZ3S	Rectifier Diode for Alternator	127
SEL6410E	3ø Round Type LED, Direct mount supported	135	SELU5820C-S	5mm Pitch Lead Rectangular LED, Direct mount supported	136	SG-10LR	Rectifier Diode for Alternator	127

Part Number Index in Alphanumeric Order

Part No.	Description	Page
SG-10LS	Rectifier Diode for Alternator	127
SG-10LXR	Rectifier Diode for Alternator	127
SG-10LXS	Rectifier Diode for Alternator	127
SG-10LZ23R	Rectifier Diode for Alternator	127
SG-10LZ23S	Rectifier Diode for Alternator	127
SG-14LXZS	Rectifier Diode for Alternator	127
SG-14LXZS	Rectifier Diode for Alternator	127
SHV-01JN	High-Voltage Rectifier Diode for Ignition Coil	128
SHV-05J	High-Voltage Rectifier Diode for Ignition Coil	128
SHV-06JN	High-Voltage Rectifier Diode for Ignition Coil	128
SI-3001S	Linear Regulator IC	8
SI-3003S	Linear Regulator IC	10
SI-3101S	Linear Regulator IC	12
SI-3102S	Linear Regulator IC	14
SI-3201S	Switching Regulator IC	22
SI-3322S	System Regulator IC	16
SI-5151S	High-side Power Switch IC	26
SI-5152S	High-side Power Switch IC	28
SI-5153S	High-side Power Switch IC	30
SI-5154S	High-side Power Switch IC	32
SI-5155S	High-side Power Switch IC	34
SI-5300	Full-bridge Motor Driver IC	60
SID1003BQ	5ø Round Infrade LED	140
SID1010CM	5ø Round Infrade LED	140
SID1010CXM	5ø Round Infrade LED	140
SID1050CM	5ø Round Infrade LED, Direct mount supported	140
SID1G307C	5ø Round Infrade LED	140
SID1G313C	5ø Round Infrade LED	140
SID1K10CM	5ø Round Infrade LED	140
SID1K10CXM	5ø Round Infrade LED	140
SID2010C	3ø Round Infrade LED	140
SID2K10C	3ø Round Infrade LED	140
SID303C	5ø Round Infrade LED	140
SID307BR	5ø Round Infrade LED	140
SID313BP	5ø Round Infrade LED	140
SJPZ-E18	Power Zener Diode (Surface Mount)	129
SJPZ-E27	Power Zener Diode (Surface Mount)	129
SJPZ-E33	Power Zener Diode (Surface Mount)	129
SJPZ-E36	Power Zener Diode (Surface Mount)	129
SJPZ-K28	Power Zener Diode (Surface Mount)	129
SLA2402M	High Voltage Driver IC for HID Lamps	64
SLA2403M	High Voltage Driver IC for HID Lamps	68
SLA2501M	High-side Power Switch IC	36
SLA2502M	High-side Power Switch IC	38
SLA4708M	Stepper-motor Driver IC	56
SLA5027	MOS FET Array	120
SLA5098	MOS FET Array	121
SLA8004	Power transistor Array	99
SMA2409M	High Voltage Driver IC for HID Lamps	72
SMA5113	MOS FET Array	122
SML11516C	5ø Round Standard Bicolor LED	137
SML1216C	5ø Round Standard Bicolor LED	137
SML1216W	5ø Round Standard Bicolor LED	137

Part No.	Description	Page
SML1516W	5ø Round Standard Bicolor LED	137
SML1816W	5ø Round Standard Bicolor LED	137
SML19416W	5ø Round Standard Bicolor LED	137
SML72420C	3.3 x 6 Rectangular Type Bicolor LED	137
SML72423C	3.3 x 6 Bow-Shaped Type Bicolor LED	137
SML72923C	3.3 x 6 Bow-Shaped Type Bicolor LED	137
SML78420C	3.3 x 6 Rectangular Type Bicolor LED	137
SML78423C	3.3 x 6 Bow-Shaped Type Bicolor LED	137
SML79420C	3.3 x 6 Rectangular Type Bicolor LED	137
SML79423C	3.3 x 6 Bow-Shaped Type Bicolor LED	137
SMLS79723C	3.3 x 6 Bow-Shaped Type Bicolor LED	137
SMLU12D16W	5ø Round Standard Bicolor LED	137
SMLU12E16C	5ø Round Standard Bicolor LED	137
SMLU12E16W	5ø Round Standard Bicolor LED	137
SMLU18D16C	5ø Round Standard Bicolor LED	137
SMLU18D16W-S	5ø Round Standard Bicolor LED	137
SMLU72423C-S	3.3 x 6 Bow-Shaped Type Bicolor LED	137
SMLU79423C-S	3.3 x 6 Bow-Shaped Type Bicolor LED	137
SPF0001	Power transistor Array (Surface Mount)	100
SPF3004	System Regulator IC	18
SPF3006	System Regulator IC	20
SPF5002A	Low-side Power Switch IC	50
SPF5003	High-side Power Switch IC	40
SPF5004	High-side Power Switch IC	42
SPF5007	High-side Power Switch IC	44
SPF5009	Low-side Power Switch IC	52
SPF5012	Low-side Power Switch IC	54
SPF5017	High-side Power Switch IC	46
SPF5018	High-side Power Switch IC	48
SPF7211	Stepper-motor Driver IC	58
SPF7301	Full-bridge Motor Driver IC	62
SSD103	Power transistor	95
STA315A	Power transistor Array	101
STA335A	Power transistor Array	102
STA415A	Power transistor Array	103
STA460C	Power transistor Array	104
STA461C	Power transistor Array	105
STA463C	Power transistor Array	106
STA464C	Power transistor Array	107
STA508A	MOS FET Array	123
STA509A	MOS FET Array	124
SZ-10N27	Power Zener Diode (Surface Mount)	129
SZ-10N40	Power Zener Diode (Surface Mount)	129
SZ-10NN27	Power Zener Diode (Surface Mount)	129
SZ-10NN40	Power Zener Diode (Surface Mount)	129
TFC561D	3-Pin Reverse Conducting Thyrisyor for HID Lamp Ignition	125
TFC562D	3-Pin Reverse Conducting Thyrisyor for HID Lamp Ignition	126

●<http://www.sanken-ele.co.jp>

SANKEN ELECTRIC CO.,LTD. ISO 9001/14001 Certified

Sanken products are manufactured and delivered to the customer based on a strict quality and environmental control system established and certified by the ISO 9001/14001 international certification standards.

1-11-1 Nishi-Ikebukuro, Toshima-ku, Tokyo
Tel: 81-3-3986-6164 Fax: 81-3-3986-8637

■ Products: Power IC, Control IC, Hall IC, Bipolar Transistor, MOS FET, IGBT, Thyristor, Rectifier Diode, LED (Light Emitting Diode), CCFL (Cold Cathode Fluorescent Lamp), Switching Power Supply, UPS (Uninterruptible Power Supply), DC Power Supply, Inverter, Universal Airway Beacon System and Other Power Supplies and Equipments

Overseas Sales Offices

●Asia

Singapore

Sanken Electric Singapore Pte. Ltd.

150 Beach Road, #14-03 The Gateway West Singapore 189720, Singapore
Tel: 65-6291-4755 Fax: 65-6297-1744

China

Sanken Electric Hong Kong Co., Ltd.

Suite 1026 Ocean Centre, Canton Road, Tsimshatsui, Kowloon, Hong Kong
Tel: 852-2735-5262 Fax: 852-2735-5494

Sanken Electric (Shanghai) Co., Ltd.

Room 3202, Maxdo Centre, Xingyi Road 8 Changning district, Shanghai, China
Tel: 86-21-5208-1177 Fax: 86-21-5208-1757

Korea

Sanken Electric Korea Co., Ltd.

Mirae Asset Life Bldg., 6F 168, Kongduk-dong, Mapo-ku, Seoul, 121-705, Korea
Tel: 82-2-714-3700 Fax: 82-2-3272-2145

Taiwan

Taiwan Sanken Electric Co., Ltd.

Room 1801, 18th Floor, 88 Jung Shiau East Road, Sec. 2, Taipei 100, Taiwan R.O.C.
Tel: 886-2-2356-8161 Fax: 886-2-2356-8261

●North America

Allegro MicroSystems, Inc.

115 Northeast Cutoff, Worcester, MA 01606 General Information
Tel: 1-508-853-5000 Fax: 1-508-853-3353

●Europe

Sanken Power Systems (UK) Ltd.

Abercynon, Mountain Ash, Mid Glamorgan CF45 4XA, U.K.
Tel: 44-1443-742-333 Fax: 44-1443-743-354

●The information contained in this document is correct as of July 2006.

This is notification that you, as purchaser of the products/technology, are not allowed to perform any of the following:

1. Resell or retransfer these products/technology to any party intending to disturb international peace and security.
2. Use these products/technology yourself for activities disturbing international peace and security.
3. Allow any other party to use these products/technology for activities disturbing international peace and security.

Also, as purchaser of these products/technology, you agree to follow the procedures for the export or transfer of these products/technology, under the Foreign Exchange and Foreign Trade Law, when you export or transfer the products/technology abroad.



This document uses 100% recycled paper.

H1-C01ED0-0607020TA