

M51202TL,FP

VOLTAGE COMPARATOR

DESCRIPTION

The M51202TL,FP is a semiconductor integrated circuit for a voltage comparator that operates from a single power supply. Especially the M51202TL,FP has superiority as to characteristics of input current (high input resistance) and fits to wide ranged applications, for example CR timer, etc. M51202TL,FP's package is a mini SIP and FLAT package, therefore can use very easily.

FEATURES

- Low input current8nA(typ.)
- Operates at low supply voltage1.7~6.5V
- Capable of directly driving a relay or a lamp
- Including voltage surge absorbing zener diode for protection
- High output breakdown voltage18V(max.)

APPLICATION

Voltage comparator, CR timer, electric shutter, time delay circuit, oscillator (square wave)

RECOMMENDED OPERATING CONDITIONS

- Supply voltage range1.7~6.5V
- Rated supply voltage5.0V

PIN CONFIGURATION (TOP VIEW)

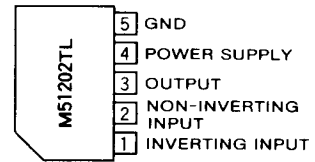

Outline 5P5T

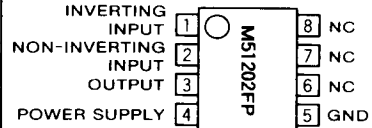

Outline 8P2S

NC : NO CONNECTION

EQUIVALENT CIRCUIT

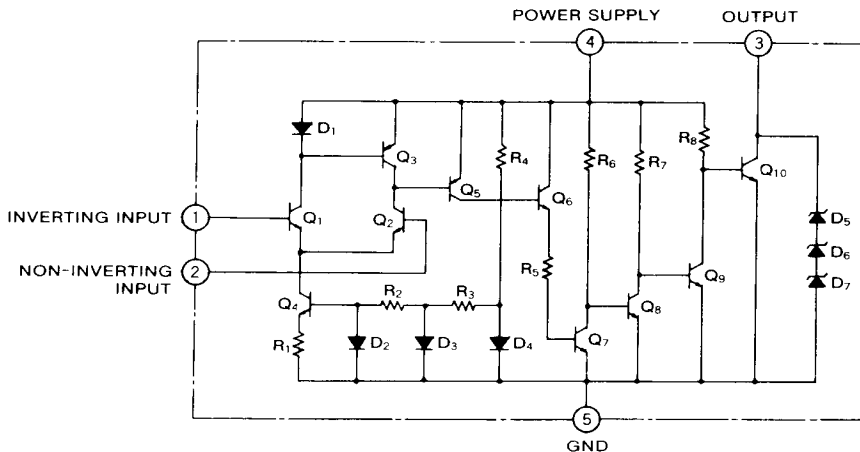

VOLTAGE COMPARATOR

ABSOLUTE MAXIMUM RATINGS ($T_a=25^\circ\text{C}$, unless otherwise noted)

Symbol	Parameter	Conditions	Ratings	Unit
V_{CC}	Supply voltage		6.5	V
I_{OL}	Output sink current	Output saturated	200	mA
V_{IN}	Input voltage		V_{CC}	V
P_d	Power dissipation		180 (M51202TL)	mW
			300 (M51202FP)	
K_θ	Thermal derating	$T_a \geq 25^\circ\text{C}$	1.8 (M51202TL)	mW/°C
			3.0 (M51202FP)	
T_{opr}	Operating temperature		-20 ~ +75	°C
T_{stg}	Storage temperature		-40 ~ +125	°C

ELECTRICAL CHARACTERISTICS ($T_a=25^\circ\text{C}$)

Symbol	Parameter	Test conditions		Limits			Unit
		V_{CC} (V)		Min	Typ	Max	
V_{CC}	Supply voltage range			1.7		6.5	V
I_{CC}	Circuit current	2.65			1.7	3.2	mA
		6.0			4.4	8.2	
I_{IN}	Input current	2.65			8	100	nA
V_{IO}	Input offset voltage	2.65			2	50	mV
V_{OL}	Output saturation voltage	6.0	$R_L=150\ \Omega$		0.2	0.6	V
V_Z	Zener voltage		$I_Z=5\text{mA}$	18	22	26	V
t_{PLH}	Output "L-H" propagation delay time	6.0	$V_{REF}=V_{CC}/2$		0.2		μs
t_{PHL}	Output "H-L" propagation delay time	6.0	$V_{REF}=V_{CC}/2$		50		μs
V_{IN}	Input voltage range			0.8		$V_{CC}-0.2$	V

TYPICAL CHARACTERISTICS ($T_a=25^\circ\text{C}$, unless otherwise noted)

THERMAL DERATING (MAXIMUM RATING)

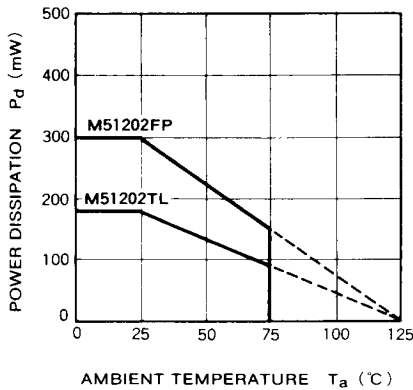

OUTPUT VOLTAGE VS. INPUT VOLTAGE

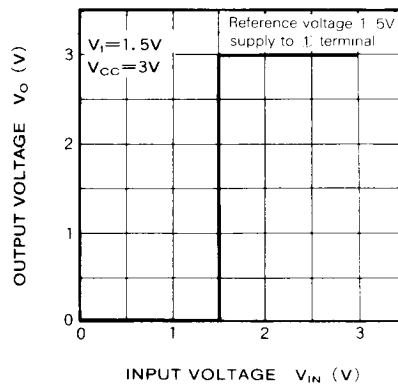

VOLTAGE COMPARATOR

INPUT CURRENT VS. INPUT VOLTAGE

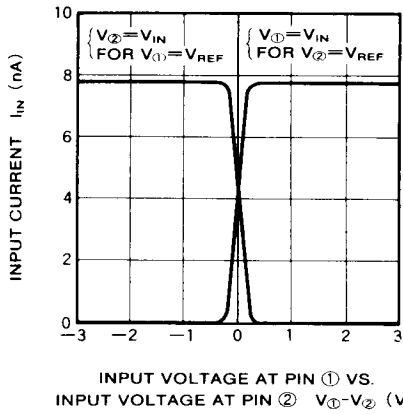

INPUT CURRENT VS. SUPPLY VOLTAGE

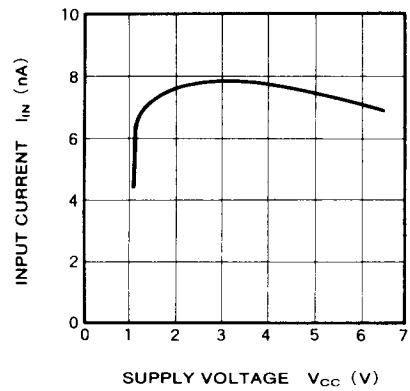

CIRCUIT CURRENT VS. SUPPLY VOLTAGE

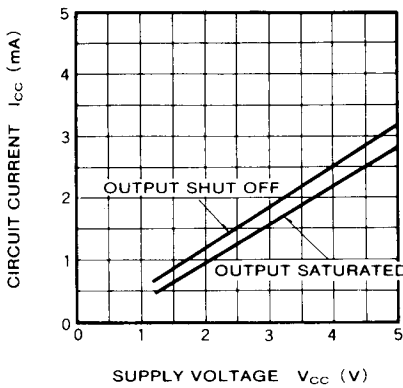

INPUT CURRENT VS. AMBIENT TEMPERATURE

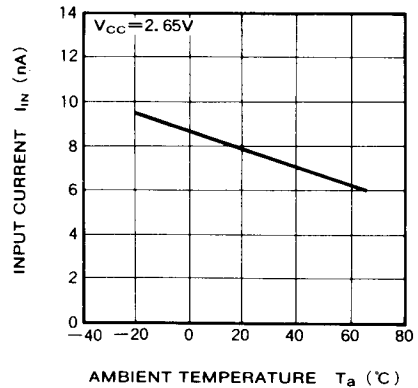

PULSE RESPONSE CHARACTERISTICS

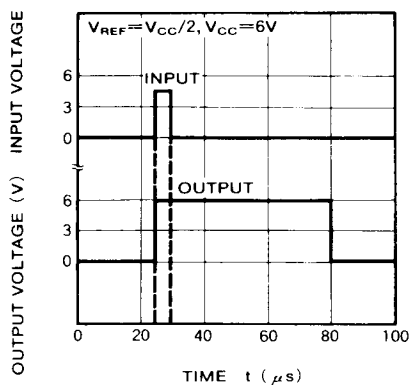

APPLICATION EXAMPLES

(1) Voltage comparator

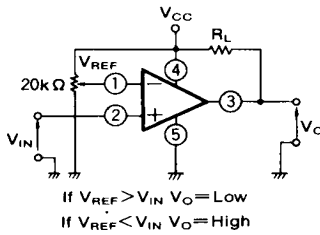

(2) CR Timer

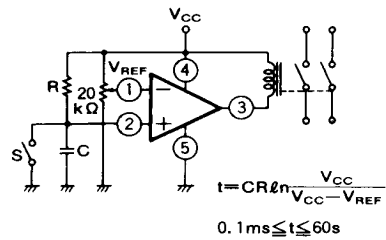

(3) Electric shutter

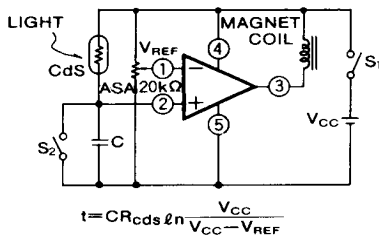

(4) Window comparator (alarm circuit)

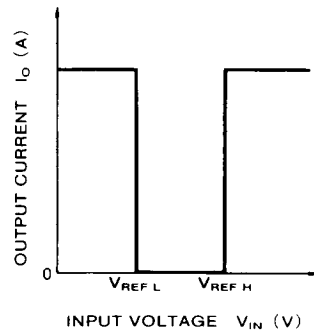
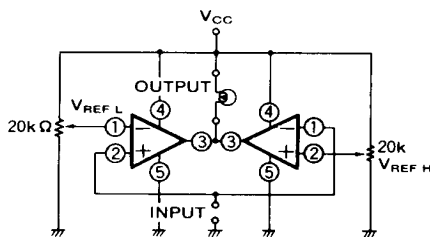

PRECAUTIONS FOR USE

1. Paying much attention is necessary for fear that the M51202TL,FP may flow large current and reach to destroy because of the structure when the terminals of V_{CC} and GND of the M51202TL,FP is connected wrong position each other.
2. Output is "open collector" and a loading resistor is not included. Connect a loading resistor to stabilize operation, in case of driving a next stage.