

# 5V Low Power RS232 3-Driver/5-Receiver Transceiver with 5 Receivers Active in Shutdown

## FEATURES

- **Low Supply Current: 300 $\mu$ A**
- **Five Receivers Kept Alive in Shutdown**
- ESD Protection Over  $\pm 10$ kV
- Operates from a Single 5V Supply
- Uses Small Capacitors: 0.1 $\mu$ F
- Operates to 120kBaud
- Three-State Outputs Are High Impedance When Off
- Output Overvoltage Does Not Force Current Back into Supplies
- RS232 I/O Lines Can Be Forced to  $\pm 25$ V Without Damage
- Pin Compatible with LT1137 and LT1237
- Flowthrough Architecture

## APPLICATIONS

- Notebook Computers
- Palmtop Computers

## DESCRIPTION

The LTC1347 is a 3-driver/5-receiver RS232 transceiver with very low supply current. In the no load condition, the supply current is only 300 $\mu$ A. The charge pump only requires four 0.1 $\mu$ F capacitors.

In Shutdown mode, all five receivers are kept alive and the supply current is 80 $\mu$ A. All RS232 outputs assume a high impedance state in Shutdown and with the power off.

The LTC1347 is fully compliant with all data rate and overvoltage RS232 specifications. The transceiver can operate up to 120kbaud with a 2500pF, 3k $\Omega$  load. Both driver outputs and receiver inputs can be forced to  $\pm 25$ V without damage, and can survive multiple  $\pm 10$ kV ESD strikes.

## TYPICAL APPLICATION

3-Drivers/5-Receivers with SHUTDOWN

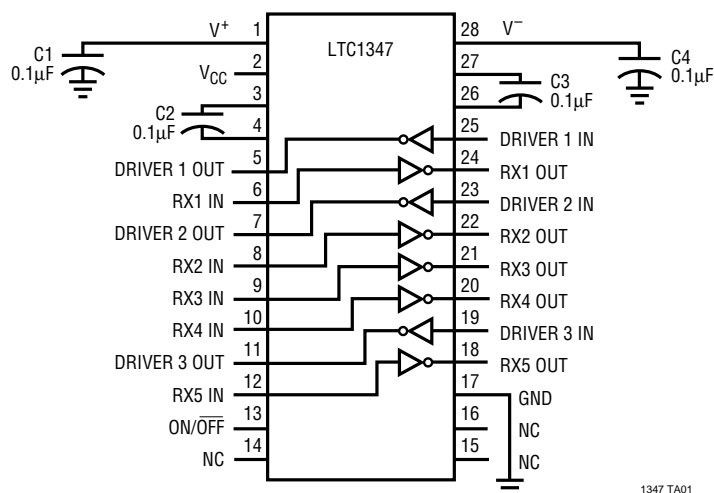

1347 TA01

Quiescent and Shutdown Supply Current vs Temperature

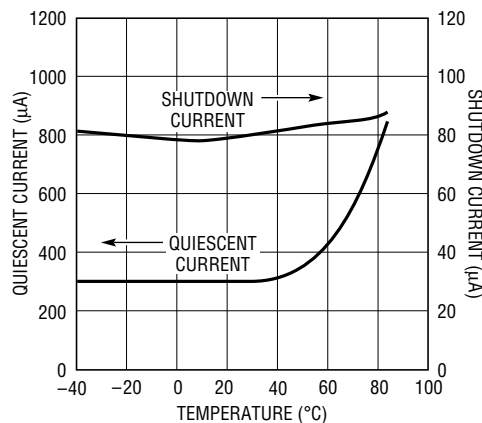

TEST CONDITION:  
V<sub>CC</sub> = 5V, ALL DRIVER INPUTS TIED TO V<sub>CC</sub>.

1347 TA02

**ABSOLUTE MAXIMUM RATINGS**

Supply Voltage ( $V_{CC}$ ) ..... 6V

Input Voltage

Driver ..... -0.3V to  $V_{CC} + 0.3V$

Receiver ..... -25V to 25V

On/Off Pin ..... -0.3V to  $V_{CC} + 0.3V$

Output Voltage

Driver ..... -25V to 25V

Receiver ..... -0.3V to  $V_{CC} + 0.3V$

Short-Circuit Duration

$V^+$  ..... 30 sec

$V^-$  ..... 30 sec

Driver Output ..... Indefinite

Receiver Output ..... Indefinite

Operating Temperature Range ..... 0°C to 70°C

Storage Temperature Range ..... -65°C to 150°C

Lead Temperature (Soldering, 10 sec) ..... 300°C

**PACKAGE/ORDER INFORMATION**

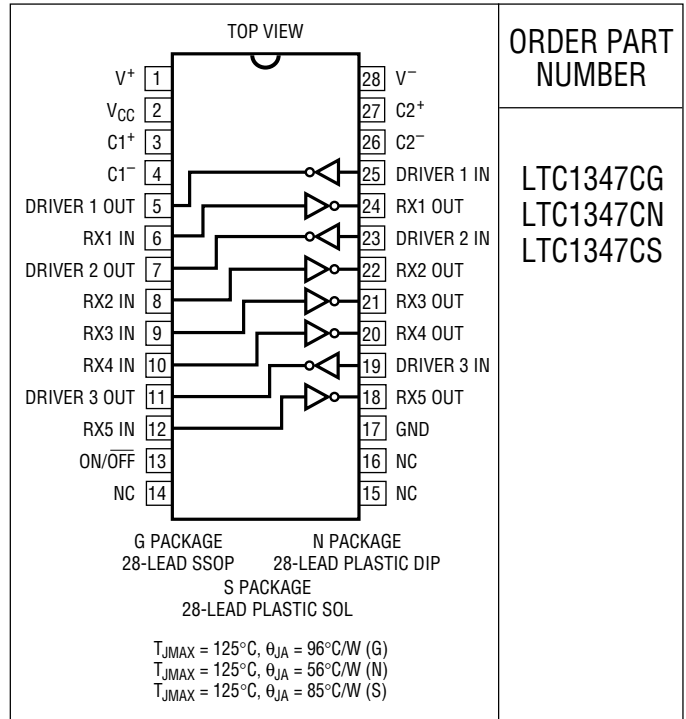

ORDER PART NUMBER

LTC1347CG  
 LTC1347CN  
 LTC1347CS

Consult factory for Industrial and Military grade parts.

**DC ELECTRICAL CHARACTERISTICS**  $V_{CC} = 5V, C1 = C2 = C3 = C4 = 0.1\mu F$ , unless otherwise noted.

PARAMETER	CONDITIONS	MIN	TYP	MAX	UNITS
<b>Any Driver</b>					
Output Voltage Swing	3k to GND	Positive Negative	5.0 -5.0	7.0 -6.5	V V
Logic Input Voltage Level	Input Low Level ( $V_{OUT} = \text{High}$ ) Input High Level ( $V_{OUT} = \text{Low}$ )		2.0	1.4 1.4	0.8 V
Logic Input Current	$V_{IN} = 5V$ $V_{IN} = 0V$			5 -5	$\mu A$ $\mu A$
Output Short-Circuit Current	$V_{OUT} = 0V$			$\pm 12$	mA
Output Leakage Current	Shutdown, $V_{OUT} = \pm 20V$ (Note 3)			$\pm 10$	$\pm 500$ $\mu A$
<b>Any Receiver</b>					
Input Voltage Thresholds	Input Low Threshold Input High Threshold		0.8	1.3 1.7	2.4 V
Hysteresis			0.1	0.4	1.0 V
Input Resistance	$V_{IN} = \pm 10V$		3	5	7 k $\Omega$
Output Voltage	Output Low, $I_{OUT} = -1.6mA$ ( $V_{CC} = 5V$ ) Output High, $I_{OUT} = 160\mu A$ ( $V_{CC} = 5V$ )		3.5	0.2 4.8	0.4 V
Output Short-Circuit Current	Sinking Current, $V_{OUT} = V_{CC}$ Sourcing Current, $V_{OUT} = 0V$		-15 10	-40 20	mA mA

## DC ELECTRICAL CHARACTERISTICS $V_{CC} = 5V, C1 = C2 = C3 = C4 = 0.1\mu F$ , unless otherwise noted.

PARAMETER	CONDITIONS	MIN	TYP	MAX	UNITS
<b>Power Supply Generator</b>					
V <sup>+</sup> Output Voltage	$I_{OUT} = 0mA$		8.0		V
	$I_{OUT} = 12mA$		7.5		V
V <sup>-</sup> Output Voltage	$I_{OUT} = 0mA$		-8.0		V
	$I_{OUT} = -12mA$		-7.0		V
Supply Rise Time	Shutdown to Turn-On		0.2		ms
<b>Power Supply</b>					
V <sub>CC</sub> Supply Current	No Load (All Drivers V <sub>IN</sub> = 5V) (Note 2)	●	0.6	1.1	mA
	No Load (All Drivers V <sub>IN</sub> = 0V) (Note 2)	●	0.8	1.3	mA
	Shutdown (Note 3)	●	80.0	120.0	μA
On/Off Threshold Low		●	1.4	0.8	V
On/Off Threshold High		●	2.0	1.4	V

## AC CHARACTERISTICS $V_{CC} = 5V, C1 = C2 = C3 = C4 = 0.1\mu F$ , unless otherwise noted.

PARAMETER	CONDITIONS	MIN	TYP	MAX	UNITS
Slew Rate	$R_L = 3k, C_L = 51pF$		8	30	V/μs
	$R_L = 3k, C_L = 2500pF$	3	5		V/μs
Driver Propagation Delay (TTL to RS232)	$t_{HLD}$ (Figure 1)	●	2	3.5	μs
	$t_{LHD}$ (Figure 1)	●	2	3.5	μs
Receiver Propagation Delay (RS232 to TTL)	$t_{HLR}$ (Figure 2)	●	0.3	0.8	μs
	$t_{LHR}$ (Figure 2)	●	0.2	0.8	μs

The ● denotes specifications which apply over the operating temperature range ( $0^{\circ}C \leq T_A \leq 70^{\circ}C$  for commercial grade).

**Note 1:** Absolute maximum ratings are those values beyond which the life of the device may be impaired.

**Note 2:** Supply current is measured with driver and receiver outputs unloaded.

**Note 3:** Supply current and leakage current measurements in Shutdown are performed with  $V_{ON/OFF} = 0V$ .

## TYPICAL PERFORMANCE CHARACTERISTICS

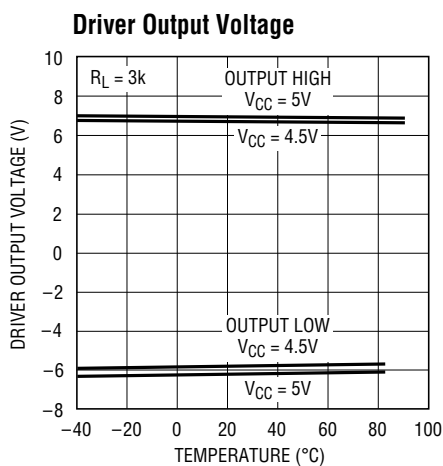

1347 G01

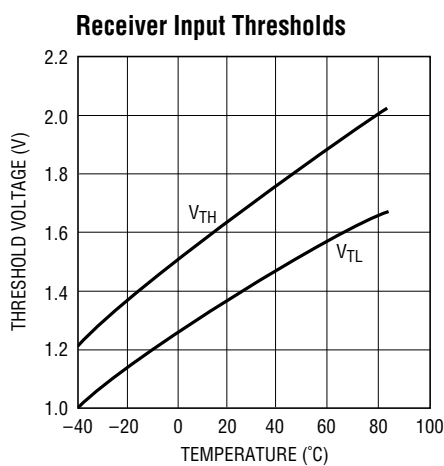

1347 G02

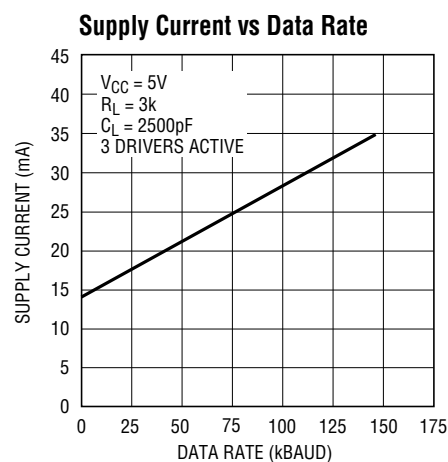

1347 G03

## TYPICAL PERFORMANCE CHARACTERISTICS

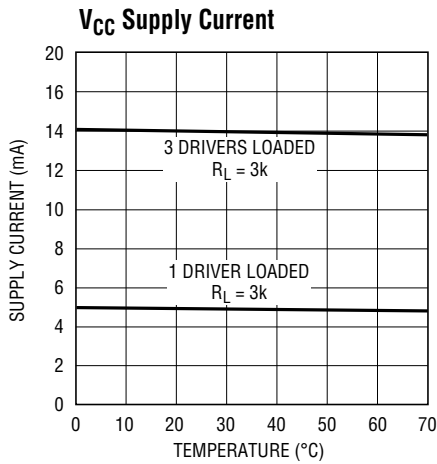

1347 G04

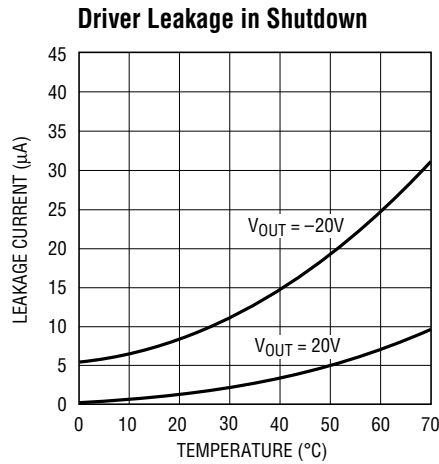

1347 G05

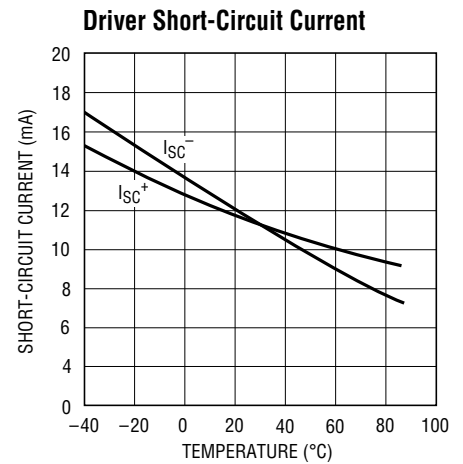

1347 G06

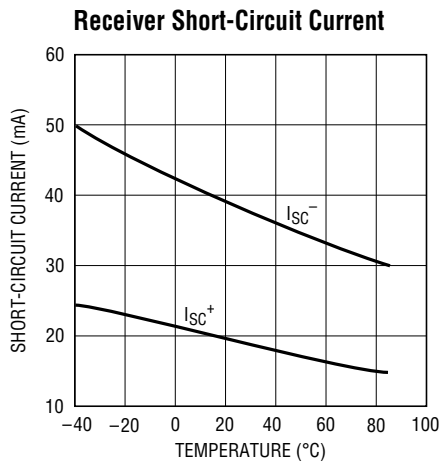

1347 G07

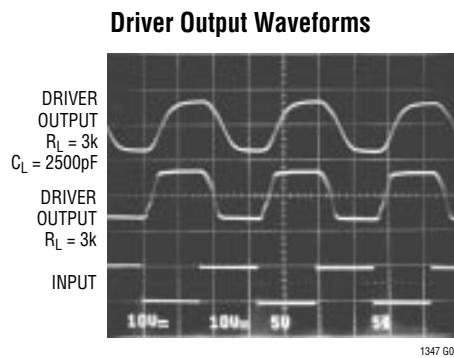

1347 G08

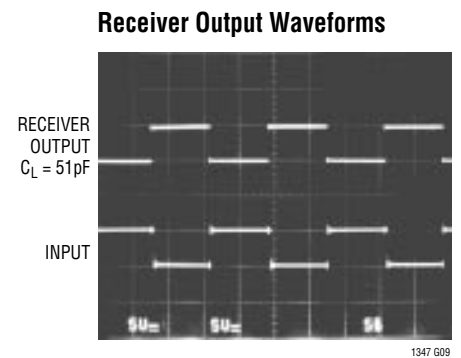

1347 G09

## PIN FUNCTIONS

**V<sub>CC</sub>**: 5V Input Supply Pin. Supply current is typically 80µA in the Shutdown mode. This pin should be decoupled with a 0.1µF ceramic capacitor.

**GND**: Ground Pin.

**ON/OFF**: TTL/CMOS Compatible Shutdown Pin. A logic low puts the device in the shutdown mode with all receivers kept alive, and the supply current is 80µA. All driver outputs are in high impedance state. This pin cannot float.

**V<sup>+</sup>**: Positive Supply Output (RS232 Drivers). V<sup>+</sup> ≅ 2V<sub>CC</sub> - 1V. This pin requires an external capacitor C

= 0.1µF for charge storage. The capacitor may be tied to ground or V<sub>CC</sub>. With multiple devices, the V<sup>+</sup> and V<sup>-</sup> pins may be paralleled into common capacitors. For large numbers of devices, increasing the size of the shared common storage capacitors is recommended to reduce ripple.

**V<sup>-</sup>**: Negative Supply Output (RS232 Drivers). V<sup>-</sup> ≅ -(2V<sub>CC</sub> - 1.5V). This pin requires an external capacitor C = 0.1µF for charge storage.

## PIN FUNCTIONS

**C1<sup>+</sup>, C1<sup>-</sup>, C2<sup>+</sup>, C2<sup>-</sup>:** Commutating Capacitor Inputs. These pins require two external capacitors  $C = 0.1\mu\text{F}$ : one from C1<sup>+</sup> to C1<sup>-</sup>, and another from C2<sup>+</sup> to C2<sup>-</sup>. To maintain charge pump efficiency, the capacitor's effective series resistance should be less than  $2\Omega$ .

**DRIVER IN:** RS232 Driver Input Pins. Inputs are TTL/CMOS compatible. Inputs should not be allowed to float. Tie unused inputs to  $V_{CC}$ .

**DRIVER OUT:** Driver Outputs at RS232 Voltage Levels. Outputs are in a high impedance state when in shutdown

mode or  $V_{CC} = 0\text{V}$ . The driver outputs are protected against ESD to  $\pm 10\text{kV}$  for human body model discharges.

**RX IN:** Receiver Inputs. These pins can be forced to  $\pm 25\text{V}$  without damage. The receiver inputs are protected against ESD to  $\pm 10\text{kV}$  for human body model discharges. Each receiver provides  $0.4\text{V}$  of hysteresis for noise immunity.

**RX OUT:** Receiver Outputs with TTL/CMOS Voltage Levels. All receivers are kept alive in shutdown.

## SWITCHING TIME WAVEFORMS

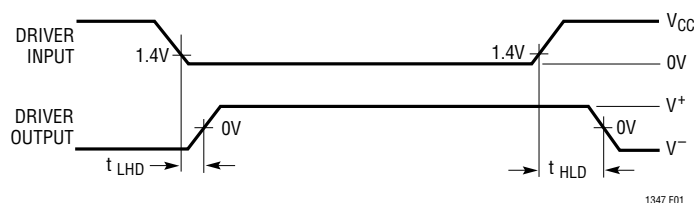

Figure 1. Driver Propagation Delay Timing

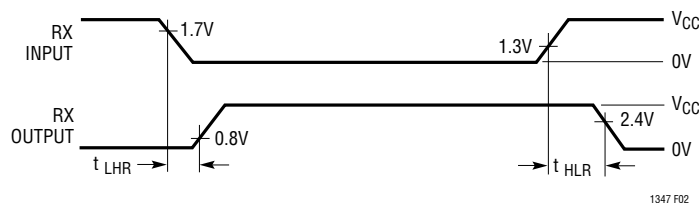

Figure 2. Receiver Propagation Delay Timing

TEST CIRCUITS

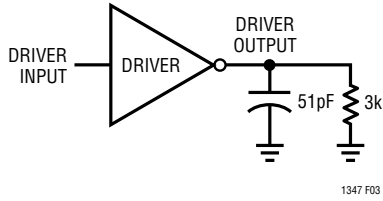

Figure 3. Driver Timing Test Load

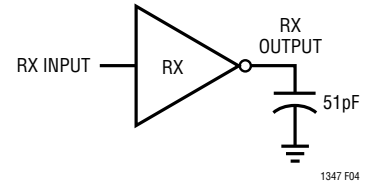

Figure 4. Receiver Timing Test Load

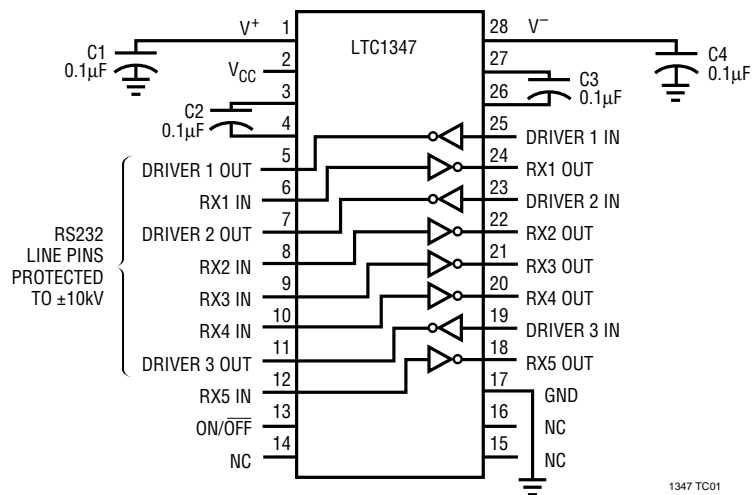
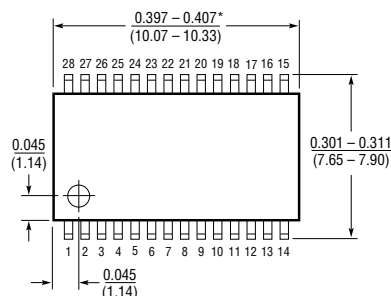
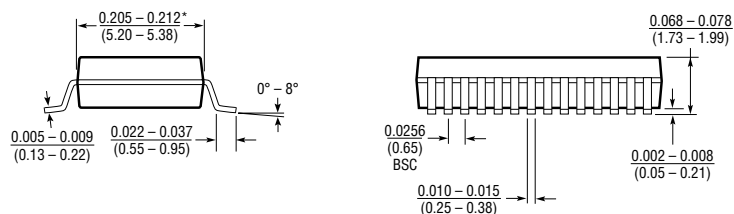

Figure 5. ESD Test Circuit

**PACKAGE DESCRIPTION** Dimensions in inches (millimeters) unless otherwise noted.

**G Package  
28-Lead SSOP**



\*THESE DIMENSIONS DO NOT INCLUDE MOLD FLASH OR PROTRUSIONS.  
MOLD FLASH OR PROTRUSIONS SHALL NOT EXCEED 0.006 INCH (0.15mm).

**N Package  
28-Lead Plastic DIP**

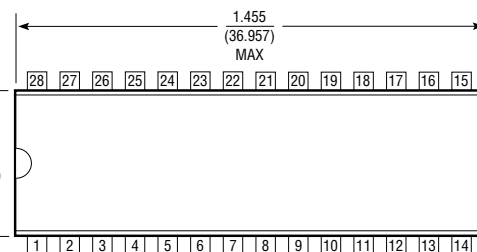
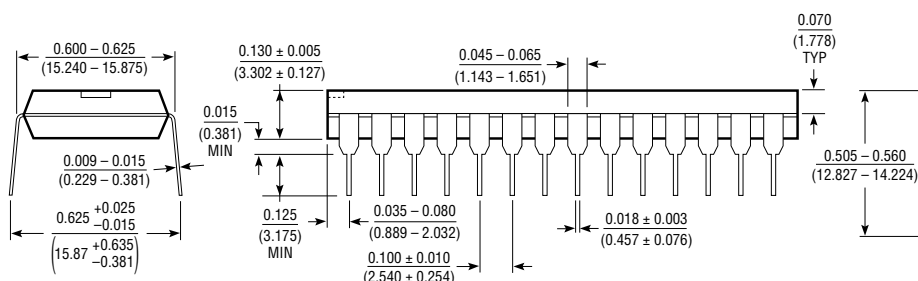

**S Package  
28-Lead Plastic SOL**

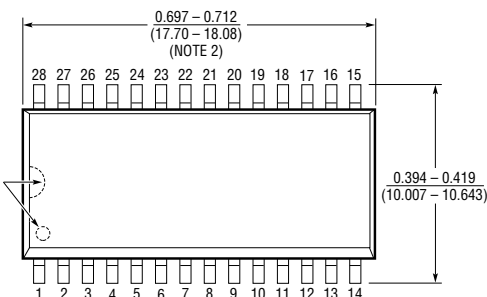
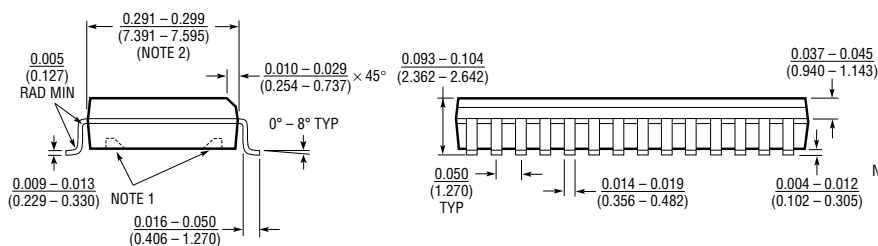

- NOTE:
- PIN 1 IDENT, NOTCH ON TOP AND CAVITIES ON THE BOTTOM OF PACKAGES ARE THE MANUFACTURING OPTIONS. THE PART MAY BE SUPPLIED WITH OR WITHOUT ANY OF THE OPTIONS.
  - THESE DIMENSIONS DO NOT INCLUDE MOLD FLASH OR PROTRUSIONS. MOLD FLASH OR PROTRUSIONS SHALL NOT EXCEED 0.006 INCH (0.15mm).

**U.S. Area Sales Offices****NORTHEAST REGION**

**Linear Technology Corporation**  
 One Oxford Valley  
 2300 E. Lincoln Hwy., Suite 306  
 Langhorne, PA 19047  
 Phone: (215) 757-8578  
 FAX: (215) 757-5631

**Linear Technology Corporation**

266 Lowell St., Suite B-8  
 Wilmington, MA 01887  
 Phone: (508) 658-3881  
 FAX: (508) 658-2701

**SOUTHEAST REGION**

**Linear Technology Corporation**  
 17060 Dallas Parkway  
 Suite 208  
 Dallas, TX 75248  
 Phone: (214) 733-3071  
 FAX: (214) 380-5138

**CENTRAL REGION**

**Linear Technology Corporation**  
 Chesapeake Square  
 229 Mitchell Court, Suite A-25  
 Addison, IL 60101  
 Phone: (708) 620-6910  
 FAX: (708) 620-6977

**SOUTHWEST REGION**

**Linear Technology Corporation**  
 22141 Ventura Blvd.  
 Suite 206  
 Woodland Hills, CA 91364  
 Phone: (818) 703-0835  
 FAX: (818) 703-0517

**NORTHWEST REGION**

**Linear Technology Corporation**  
 782 Sycamore Dr.  
 Milpitas, CA 95035  
 Phone: (408) 428-2050  
 FAX: (408) 432-6331

**International Sales Offices****FRANCE**

**Linear Technology S.A.R.L.**  
 Immeuble "Le Quartz"  
 58 Chemin de la Justice  
 92290 Chatenay Malabry  
 France  
 Phone: 33-1-41079555  
 FAX: 33-1-46314613

**GERMANY**

**Linear Technolgy GmbH**  
 Untere Hauptstr. 9  
 D-85386 Eching  
 Germany  
 Phone: 49-89-3197410  
 FAX: 49-89-3194821

**JAPAN**

**Linear Technology KK**  
 5F YZ Bldg.  
 4-4-12 Iidabashi, Chiyoda-Ku  
 Tokyo, 102 Japan  
 Phone: 81-3-3237-7891  
 FAX: 81-3-3237-8010

**KOREA**

**Linear Technology Korea Branch**  
 Namsong Building, #505  
 Itaewon-Dong 260-199  
 Yongsan-Ku, Seoul  
 Korea  
 Phone: 82-2-792-1617  
 FAX: 82-2-792-1619

**SINGAPORE**

**Linear Technology Pte. Ltd.**  
 101 Boon Keng Road  
 #02-15 Kallang Ind. Estates  
 Singapore 1233  
 Phone: 65-293-5322  
 FAX: 65-292-0398

**TAIWAN**

**Linear Technology Corporation**  
 Rm. 801, No. 46, Sec. 2  
 Chung Shan N. Rd.  
 Taipei, Taiwan, R.O.C.  
 Phone: 886-2-521-7575  
 FAX: 886-2-562-2285

**UNITED KINGDOM**

**Linear Technology (UK) Ltd.**  
 The Coliseum, Riverside Way  
 Camberley, Surrey GU15 3YL  
 United Kingdom  
 Phone: 44-276-677676  
 FAX: 44-276-64851

**World Headquarters**

**Linear Technology Corporation**  
 1630 McCarthy Blvd.  
 Milpitas, CA 95035-7487  
 Phone: (408) 432-1900  
 FAX: (408) 434-0507