



High Density Mounting Type Photocoupler

LTV817/LTV827/LTV847

T-41-83

PHOTOCOUPERS

FEATURES

1. Current transfer ratio
CTR: MIN. 50% at $I_F = 5\text{mA}$, $V_{CE} = 5\text{V}$
2. High input-output isolation voltage
(V_{ISO} : 5,000 Vrms)
3. Compact dual-in-line package
LTV817: 1-channel type, LTV827: 2-channel type
LTV847: 4-channel type
4. UL approved (No. E 113898(s))

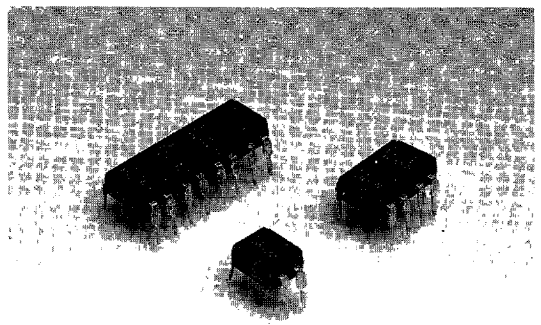

APPLICATIONS

1. Computer terminals
2. System appliances, measuring instruments
3. Registers, copiers, automatic vending machines
4. Electric home appliances such as fan heaters, etc.
5. Medical instruments, physical and chemical equipments.
6. Signal transmission between circuits of different potentials and impedances

OUTLINE DIMENSIONS (UNIT: mm)

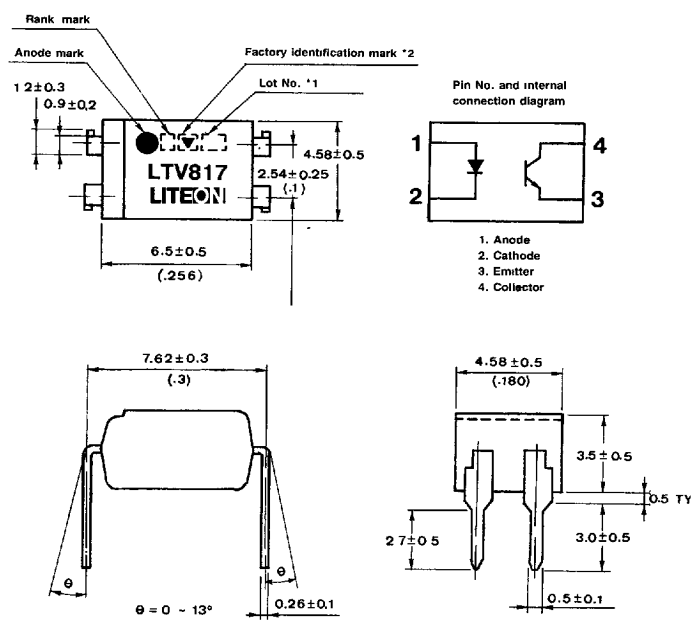

*1 2-digit number marked according to DIN standard
 *2 Two versions available, one with factory identification mark and the other without

T-41-83

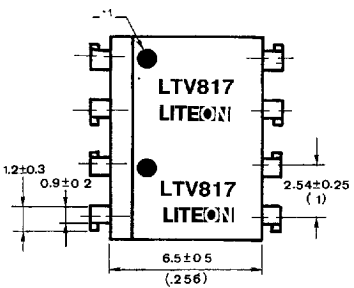

Pin No. and internal connection diagram

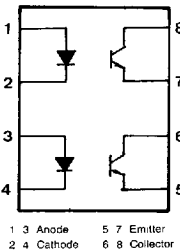

- 1 3 Anode
- 2 4 Cathode
- 5 7 Emitter
- 6 8 Collector

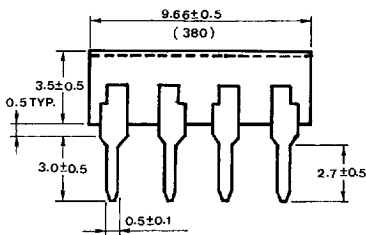
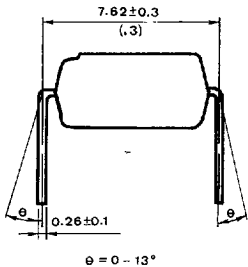

Note: *1 Anode mark

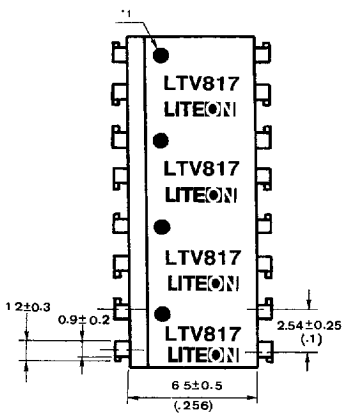

Pin No. and internal connection diagram

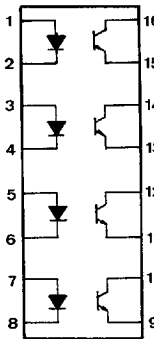

- 1 3 5 7 Anode
- 2 4 6 8 Cathode
- 9 11 13 15 Emitter
- 10 12 14 16 Collector

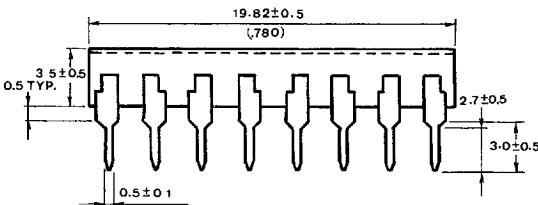
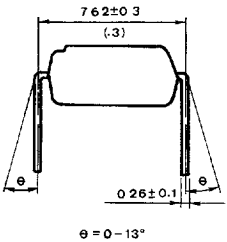

Note: *1 Anode mark

T-41-83

■ RATINGS AND CHARACTERISTICS

• Absolute maximum ratings

(Ta=25°C)

Parameter		Symbol	Rating	Unit
Input	Forward current	I_F	50	mA
	*1 Peak forward current	I_{FM}	1	A
	Reverse voltage	V_R	6	V
	Power dissipation	P	70	mW
Output	Collector-emitter voltage	V_{CEO}	35	V
	Emitter-collector voltage	V_{ECO}	6	V
	Collector current	I_C	50	mA
	Collector power dissipation	P_C	150	mW
Total power dissipation		P_{tot}	200	mW
Operating temperature		T_{opr}	-30 ~ +100	°C
Storage temperature		T_{stg}	-55 ~ +125	°C
*2 Isolation voltage		V_{iso}	5	kVrms
*3 Soldering temperature		T_{sol}	260	°C

*1 Pulse width $\leq 100\mu s$, Duty ratio: 0.001

*2 AC for 1 minute, 40~60% R.H.

*3 For 10 seconds

• Electro-optical characteristics

(Ta=25°C)

Parameter		Symbol	Min.	Typ.	Max.	Unit	Conditions
Input	Forward voltage	V_F	—	1.2	1.4	V	$I_F = 20\text{mA}$
	Peak forward voltage	V_{FM}	—	—	3.0	V	$I_{FM} = 0.5\text{A}$
	Reverse current	I_R	—	—	10	μA	$V_R = 4\text{V}$
	Terminal capacitance	C_t	—	30	250	pF	$V = 0, f = 1\text{kHz}$
Output	Collector dark current	I_{CEO}	—	—	100	nA	$V_{CE} = 20\text{V}, I_F = 0, R_{BE} = \infty$
	Collector-emitter breakdown voltage	BV_{CEO}	35	—	—	V	$I_C = 0.1\text{mA}, I_F = 0$
	Emitter-collector breakdown voltage	BV_{ECO}	6	—	—	V	$I_E = 10\mu\text{A}, I_F = 0$
Transfer characteristics	* Collector current	I_C	2.5	—	30	mA	$I_F = 5\text{mA}, V_{CE} = 5\text{V}$
	Collector-emitter saturation voltage	$V_{CE}(\text{sat})$	—	0.1	0.2	V	$I_F = 20\text{mA}, I_C = 1\text{mA}$
	Isolation resistance	R_{ISO}	5×10^{10}	10^{11}	—	Ω	500V DC, 40~60% R.H.
	Floating capacitance	C_f	—	0.6	1.0	pF	$V = 0, f = 1\text{MHz}$
	Cut-off frequency	f_c	—	80	—	kHz	$V_{CE} = 5\text{V}, I_C = 2\text{mA}$ $R_L = 100\Omega, -3\text{dB}$
	Response time (Rise)	t_r	—	4	18	μs	$V_{CE} = 2\text{V}, I_C = 2\text{mA},$ $R_L = 100\Omega$
	Response time (Fall)	t_f	—	3	18	μs	

A-85
100

$$*CTR = \frac{I_C}{I_F} \times 100\%$$

T-41-83

■ SUPPLEMENT

• **Isolation voltage shall be measured in the following method.**

- (1) Anode and cathode on input side, collector and emitter on output side shall be shortened individually.
 - (2) The isolation voltage tester with a zero-cross circuit shall be used.
 - (3) The waveform of applied voltage shall be a sine wave.
- (It is recommended that the isolation voltage shall be measured in insulation oil.)

• **Rank table of collector current I_C (for LTV 817 only)**

Model No.	Rank mark	I _C (mA)
LTV817A	A	4.0~8.0
LTV817B	B	6.5~13
LTV817C	C	10~20
LTV817D	D	15~30
LTV817	A, B, C, D or No mark	2.5~30

Conditions	I _F = 5mA V _{CE} = 5V T _a = 25°C
------------	---

• **Inspection standard**

Outgoing inspection standard for LITON products are shown below.

- (1) A single sampling plan, normal inspection level II based on MIL-STD-105D is applied. The AQL according to the inspection items are shown below.

Defect	Inspection item	AQL (%)	Judgement criterion
Major defect	<ul style="list-style-type: none"> • Electrical characteristics • Unreadable marking • Open, short 	0.25	Depend on the specification
Minor defect	<ul style="list-style-type: none"> • Appearance • Dimension 	0.4	

T-41-83

Fig. 1 Forward Current vs. Ambient Temperature

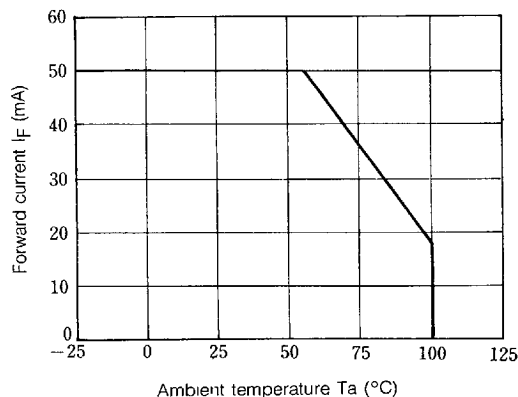

Fig. 2 Collector Power Dissipation vs. Ambient Temperature

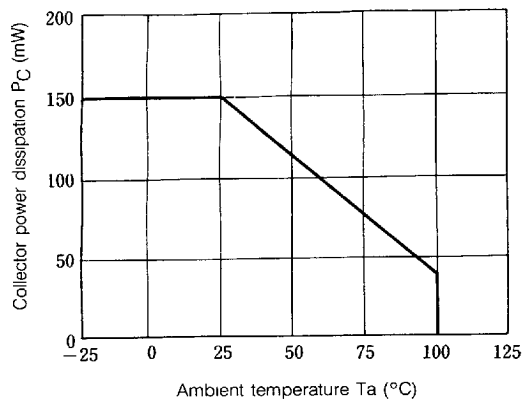

Fig. 3 Peak Forward Current vs. Duty Ratio

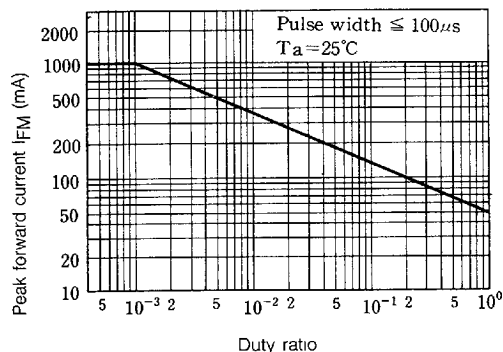

Fig. 4 Current Transfer Ratio vs. Forward Current

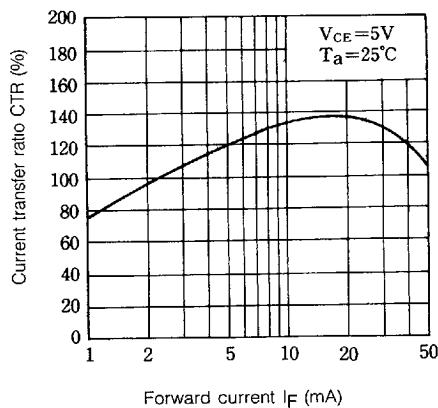

Fig. 5 Forward Current vs. Forward Voltage

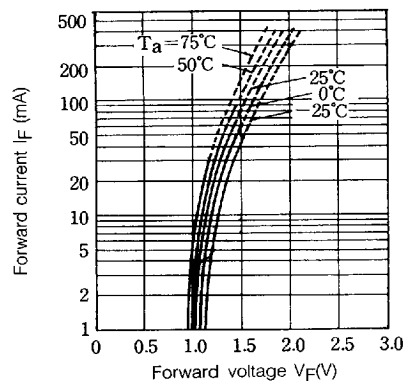
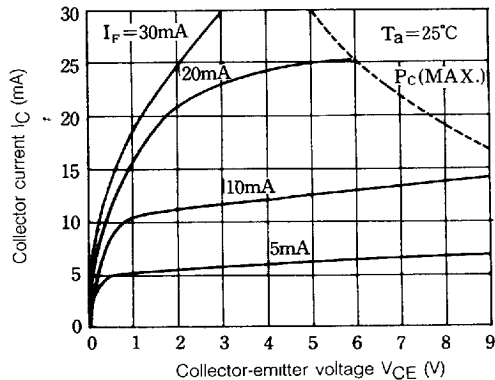

Fig. 6 Collector Current vs. Collector-emitter Voltage



T-41-83

Fig. 7 Relative Current Transfer Ratio vs. Ambient Temperature

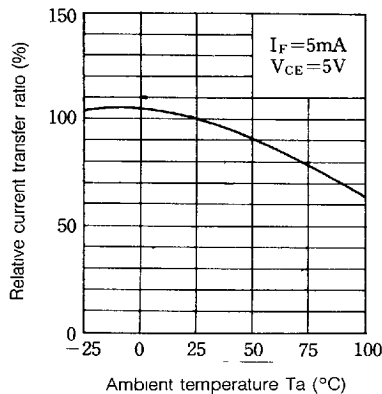

Fig. 8 Collector-emitter Saturation Voltage vs. Ambient Temperature

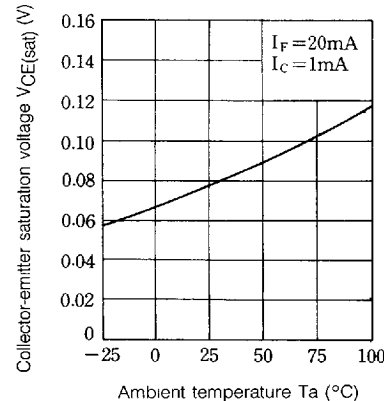

Fig. 9 Collector Dark Current vs. Ambient Temperature

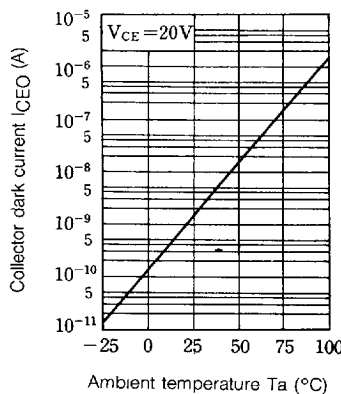

Fig. 10 Response Time vs. Load Resistance

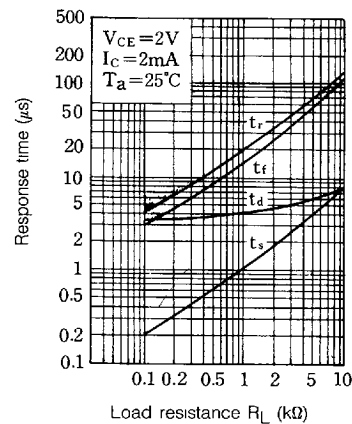

Fig. 11 Frequency Response

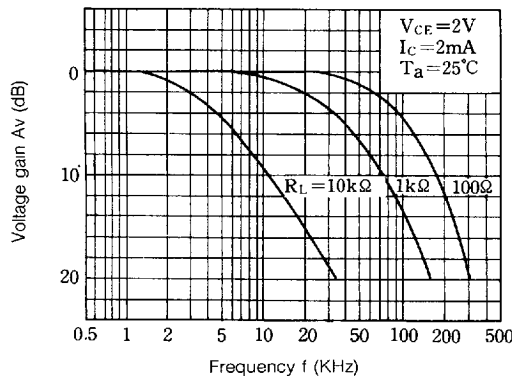
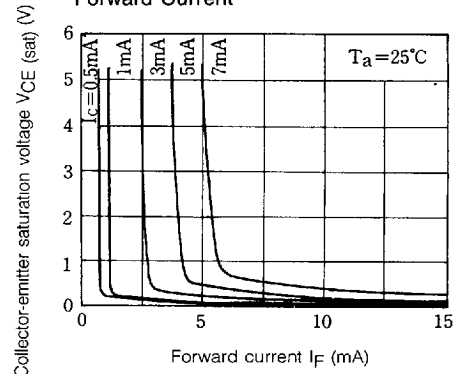
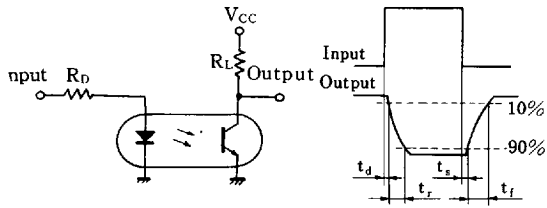

Fig. 12 Collector-emitter Saturation Voltage vs. Forward Current



Test Circuit for Response Time



Test Circuit for Frequency Response

