

OPA544

High-Voltage, High-Current OPERATIONAL AMPLIFIER

FEATURES

- HIGH OUTPUT CURRENT: 2A min
- WIDE POWER SUPPLY RANGE:
 ± 10 to ± 35 V
- SLEW RATE: 8V/ μ s
- INTERNAL CURRENT LIMIT
- THERMAL SHUTDOWN PROTECTION
- FET INPUT: $I_B = 100$ pA max
- 5-LEAD TO-220 PLASTIC PACKAGE
- 5-LEAD SURFACE MOUNT PACKAGE

APPLICATIONS

- MOTOR DRIVER
- PROGRAMMABLE POWER SUPPLY
- SERVO AMPLIFIER
- VALVES, ACTUATOR DRIVER
- MAGNETIC DEFLECTION COIL DRIVER
- AUDIO AMPLIFIER

DESCRIPTION

The OPA544 is a high-voltage/high-current operational amplifier suitable for driving a wide variety of high power loads. High performance FET op amp circuitry and high power output stage are combined on a single monolithic chip.

The OPA544 is protected by internal current limit and thermal shutdown circuits.

The OPA544 is available in industry-standard 5-lead TO-220 and 5-lead surface-mount power packages. Its copper tab allows easy mounting to a heat sink for excellent thermal performance. It is specified for operation over the extended industrial temperature range, -40°C to $+85^\circ\text{C}$.

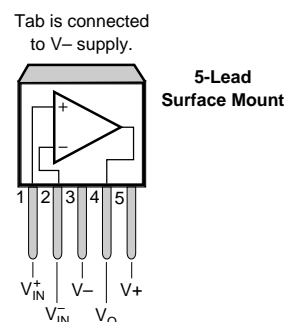
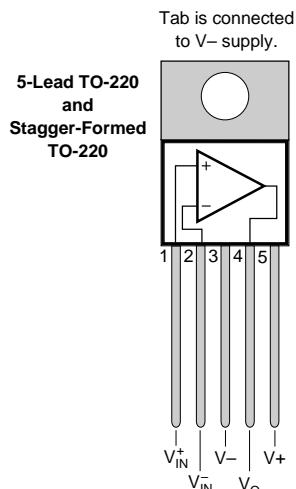

International Airport Industrial Park • Mailing Address: PO Box 11400 • Tucson, AZ 85734 • Street Address: 6730 S. Tucson Blvd. • Tucson, AZ 85706
Tel: (520) 746-1111 • Twx: 910-952-1111 • Cable: BBRCORP • Telex: 066-6491 • FAX: (520) 889-1510 • Immediate Product Info: (800) 548-6132

SPECIFICATIONS

$T_{CASE} = +25^{\circ}\text{C}$, $V_S = \pm 35\text{V}$ unless otherwise noted.

PARAMETER	CONDITION	OPA544T OPA544T-1 OPA544F			UNITS
		MIN	TYP	MAX	
OFFSET VOLTAGE Input Offset Voltage vs Temperature vs Power Supply	Specified Temperature Range $V_S = \pm 10\text{V to } \pm 35\text{V}$		± 1 ± 10 ± 10	± 5 ± 100	mV $\mu\text{V}/^{\circ}\text{C}$ $\mu\text{V}/\text{V}$
INPUT BIAS CURRENT⁽¹⁾ Input Bias Current vs Temperature Input Offset Current	$V_{CM} = 0\text{V}$ $V_{CM} = 0\text{V}$		± 15 See Typical Curve ± 10	± 100 ± 100	pA pA
NOISE Input Voltage Noise Noise Density, $f = 1\text{kHz}$ Current Noise Density, $f = 1\text{kHz}$			36 3		$\text{nV}/\sqrt{\text{Hz}}$ $\text{fA}/\sqrt{\text{Hz}}$
INPUT VOLTAGE RANGE Common-Mode Input Range, Positive Negative Common-Mode Rejection	Linear Operation Linear Operation $V_{CM} = \pm V_S - 6\text{V}$	(V+) -6 (V-) +6 90	(V+) -4 (V-) +4 106		V V dB
INPUT IMPEDANCE Differential Common-Mode			$10^{12} \parallel 8$ $10^{12} \parallel 10$		$\Omega \parallel \text{pF}$ $\Omega \parallel \text{pF}$
OPEN-LOOP GAIN Open-Loop Voltage Gain	$V_O = \pm 30\text{V}$, $R_L = 1\text{k}\Omega$	90	103		dB
FREQUENCY RESPONSE Gain Bandwidth Product Slew Rate Full-Power Bandwidth Settling Time 0.1% Total Harmonic Distortion	$R_L = 15\Omega$ 60Vp-p , $R_L = 15\Omega$ $G = -10$, 60V Step	5	1.4 8 See Typical Curve 25 See Typical Curve		MHz $\text{V}/\mu\text{s}$ μs
OUTPUT Voltage Output, Positive Negative Positive Negative Current Output Short-Circuit Current	$I_O = 2\text{A}$ $I_O = 2\text{A}$ $I_O = 0.5\text{A}$ $I_O = 0.5\text{A}$	(V+) -5 (V-) +5 (V+) -4.2 (V-) +4	(V+) -4.4 (V-) +3.8 (V+) -3.8 (V-) +3.1 See SOA Curves 4		V V V V A
POWER SUPPLY Specified Operating Voltage Operating Voltage Range Quiescent Current	 $I_O = 0$	± 10	± 35 ± 12	± 35 ± 15	V V mA
TEMPERATURE RANGE Operating Storage Thermal Resistance, θ_{JC} Thermal Resistance, θ_{JC} Thermal Resistance, θ_{JA}	 $f > 50\text{Hz}$ DC No Heat Sink	-40 -40	2.7 3 65	+85 +125	$^{\circ}\text{C}$ $^{\circ}\text{C}$ $^{\circ}\text{C}/\text{W}$ $^{\circ}\text{C}/\text{W}$ $^{\circ}\text{C}/\text{W}$

NOTES: (1) High-speed test at $T_J = 25^{\circ}\text{C}$.

The information provided herein is believed to be reliable; however, BURR-BROWN assumes no responsibility for inaccuracies or omissions. BURR-BROWN assumes no responsibility for the use of this information, and all use of such information shall be entirely at the user's own risk. Prices and specifications are subject to change without notice. No patent rights or licenses to any of the circuits described herein are implied or granted to any third party. BURR-BROWN does not authorize or warrant any BURR-BROWN product for use in life support devices and/or systems.

DICE INFORMATION

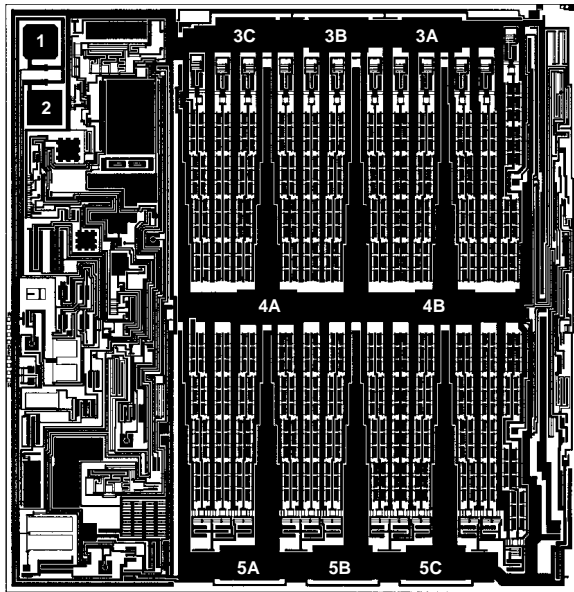

OPA544 DIE TOPOGRAPHY

PAD	FUNCTION
1	+In
2	-In
3A, 3B, 3C	V-
4A, 4B	V _O
5A, 5B, 5C	V+

Substrate Bias: Internally connected to V- power supply.

MECHANICAL INFORMATION

	MILS (0.001")	MILLIMETERS
Die Size	159 x 162 ±5	4.04 x 4.11 ±0.13
Die Thickness	14 ±3	0.36 ±0.08
Min. Pad Size	4 x 4	0.1 x 0.1
Backing	Chromium-Silver	

CONNECTION DIAGRAMS

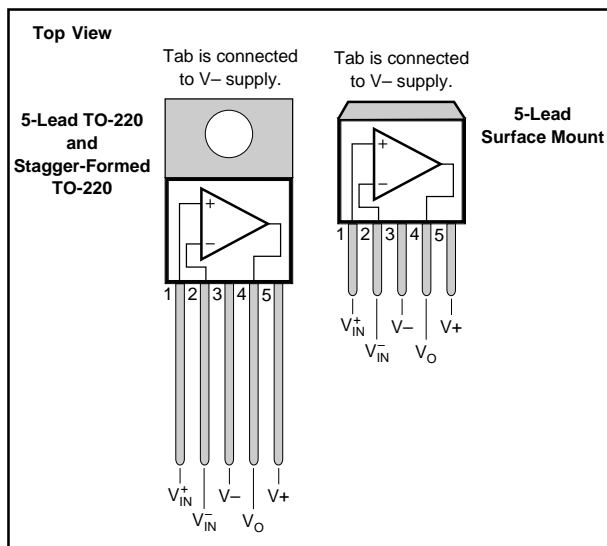

ABSOLUTE MAXIMUM RATINGS

Supply Voltage, V+ to V-	70V
Output Current	See SOA Curve
Input Voltage	(V-) -0.7V to (V+) +0.7V
Operating Temperature	-40°C to +125°C
Storage Temperature	-40°C to +125°C
Junction Temperature	150°C
Lead Temperature (soldering -10s) ⁽¹⁾	300°C

NOTE: (1) Vapor-phase or IR reflow techniques are recommended for soldering the OPA544F surface mount package. Wave soldering is not recommended due to excessive thermal shock and "shadowing" of nearby devices.

ORDERING/PACKAGE INFORMATION

MODEL	PACKAGE	PACKAGE DRAWING NUMBER ⁽¹⁾
OPA544T	5-Lead TO-220	315
OPA544T-1	5-Lead Stagger-Formed TO-220	323
OPA544F	5-Lead Surface-Mount	325

NOTE: (1) For detailed drawing and dimension table, please see end of data sheet, or Appendix D of Burr-Brown IC Data Book.

ELECTROSTATIC DISCHARGE SENSITIVITY

This integrated circuit can be damaged by ESD. Burr-Brown recommends that all integrated circuits be handled with appropriate precautions. Failure to observe proper handling and installation procedures can cause damage.

ESD damage can range from subtle performance degradation to complete device failure. Precision integrated circuits may be more susceptible to damage because very small parametric changes could cause the device not to meet its published specifications.

TYPICAL PERFORMANCE CURVES

$T_{CASE} = +25^{\circ}C$, $V_S = \pm 35V$ unless otherwise noted.

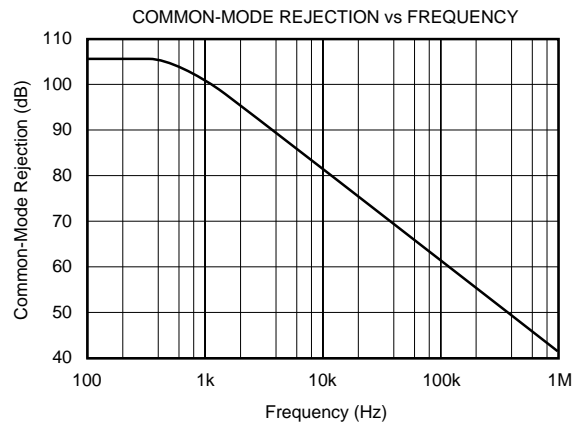
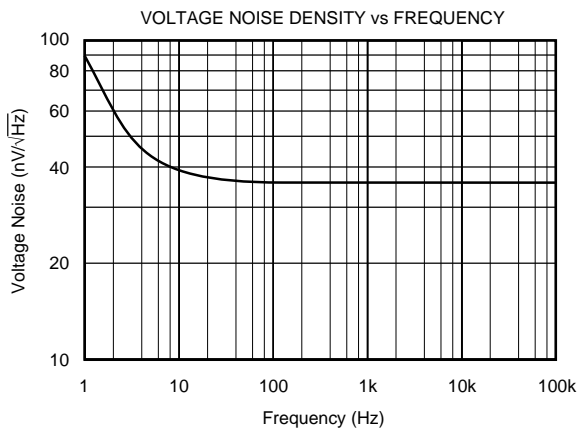
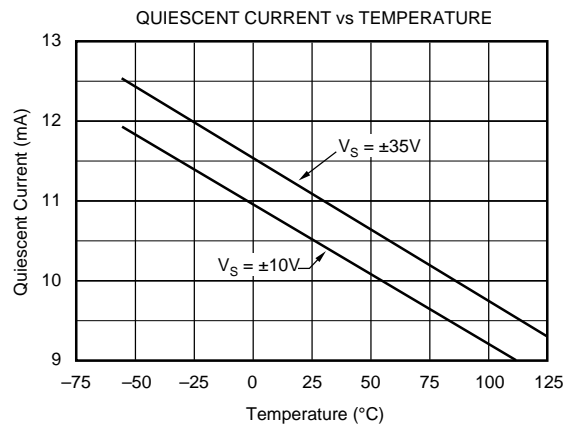
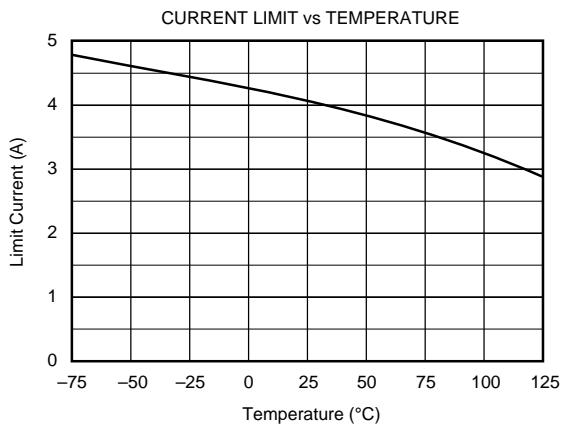
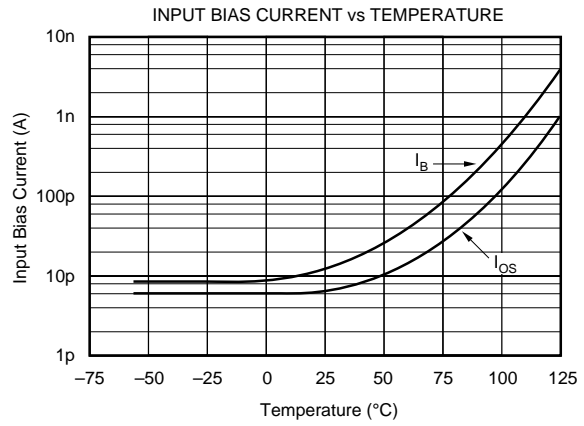
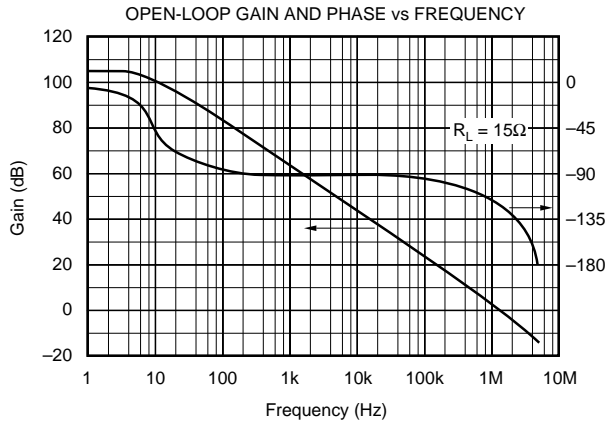

TYPICAL PERFORMANCE CURVES (CONT)

$T_{CASE} = +25^{\circ}C$, $V_S = \pm 35V$ unless otherwise noted.

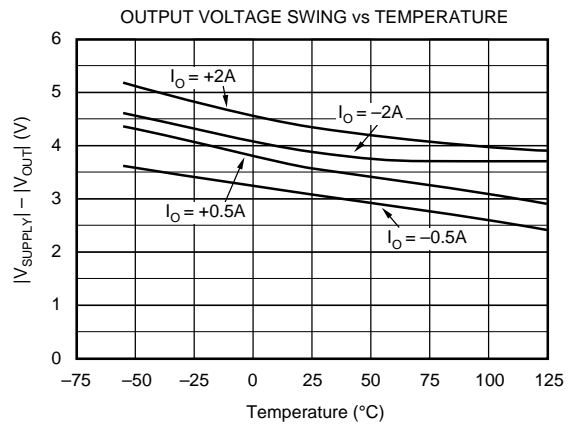
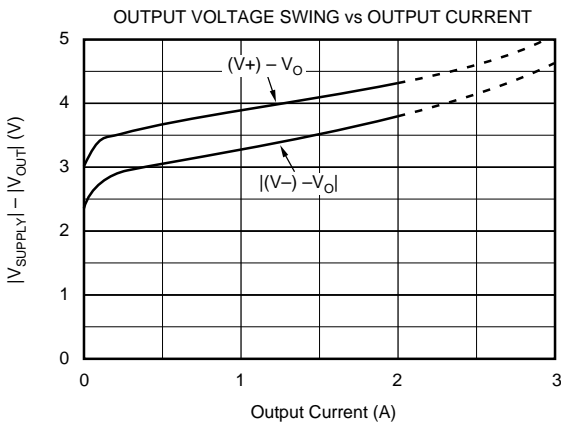
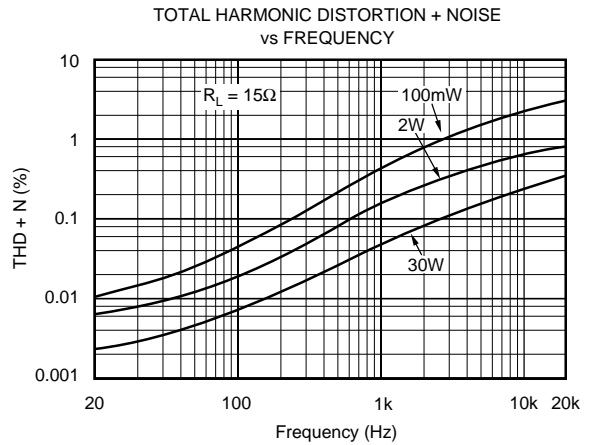
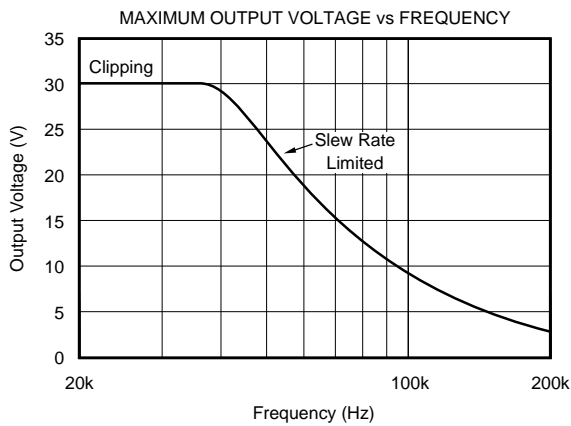
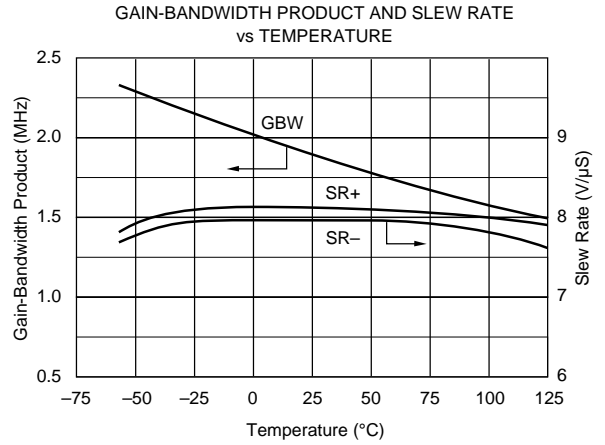
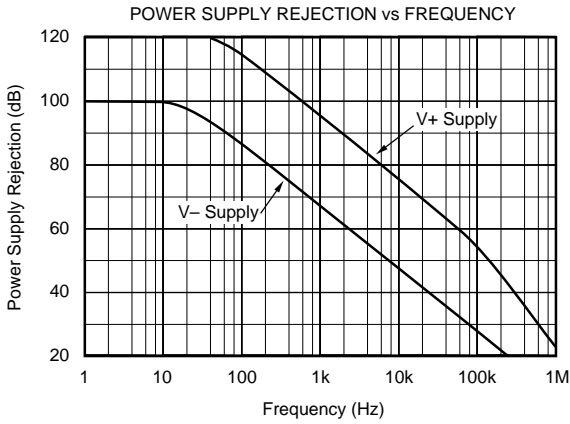

TYPICAL PERFORMANCE CURVES (CONT)

$T_{CASE} = +25^{\circ}C$, $V_S = \pm 35V$ unless otherwise noted.

SMALL SIGNAL RESPONSE
 $G = 3$, $C_L = 1nF$

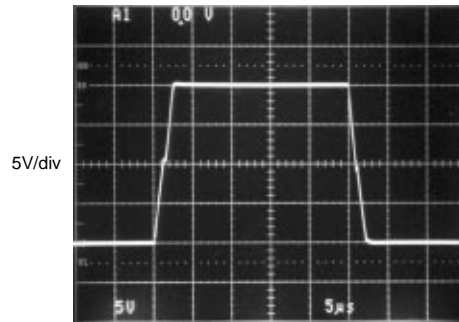
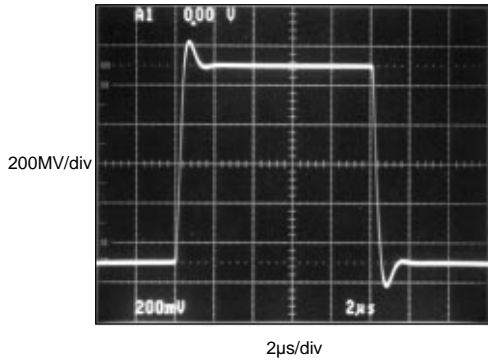

APPLICATIONS INFORMATION

Figure 1 shows the OPA544 connected as a basic non-inverting amplifier. The OPA544 can be used in virtually any op amp configuration. Power supply terminals should be bypassed with low series impedance capacitors. The technique shown, using a ceramic and tantalum type in parallel is recommended. Power supply wiring should have low series impedance and inductance.

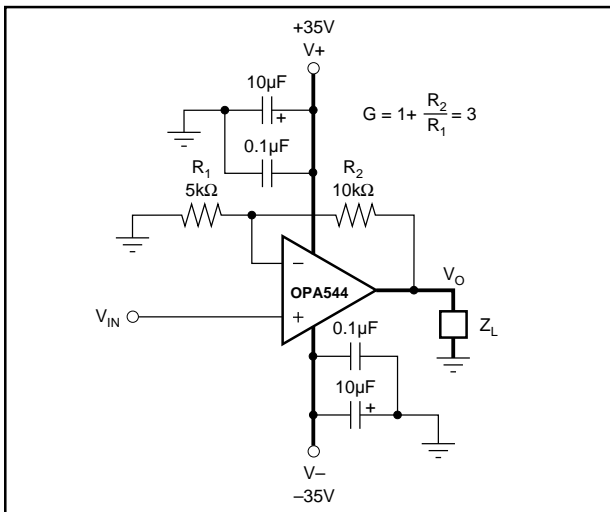

FIGURE 1. Basic Circuit Connections.

SAFE OPERATING AREA

Stress on the output transistors is determined by the output current and the voltage across the conducting output transistor, $V_S - V_O$. The power dissipated by the output transistor is equal to the product of the output current and the voltage across the conducting transistor, $V_S - V_O$. The Safe Operating Area (SOA curve, Figure 2) shows the permissible range of voltage and current.

The safe output current decreases as $V_S - V_O$ increases. Output short-circuits are a very demanding case for SOA. A short-circuit to ground forces the full power supply voltage ($V+$ or $V-$) across the conducting transistor. With $V_S = \pm 35V$ the safe output current is 1.5A (at $25^{\circ}C$). The short-circuit current is approximately 4A which exceeds the SOA. This situation will activate the thermal shutdown circuit in the OPA544. For further insight on SOA, consult Application Bulletin AB-039.

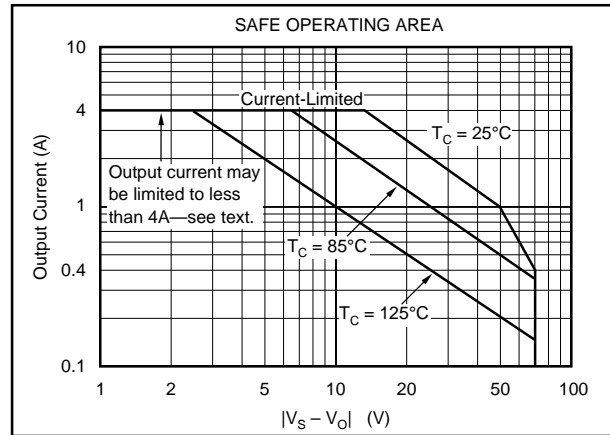

FIGURE 2. Safe Operating Area.

CURRENT LIMIT

The OPA544 has an internal current limit set for approximately 4A. This current limit decreases with increasing junction temperature as shown in the typical curve, Current Limit vs Temperature. This, in combination with the thermal shutdown circuit, provides protection from many types of overload. It may not, however, protect for short-circuit to ground, depending on the power supply voltage, ambient temperature, heat sink and signal conditions.

POWER DISSIPATION

Power dissipation depends on power supply, signal and load conditions. For dc signals, power dissipation is equal to the product of output current times the voltage across the conducting output transistor. Power dissipation can be minimized by using the lowest possible power supply voltage necessary to assure the required output voltage swing.

For resistive loads, the maximum power dissipation occurs at a dc output voltage of one-half the power supply voltage. Dissipation with ac signals is lower. Application Bulletin AB-039 explains how to calculate or measure power dissipation with unusual signals and loads.

HEATSINKING

Most applications require a heat sink to assure that the maximum junction temperature is not exceeded. The heat sink required depends on the power dissipated and on ambient conditions. Consult Application Bulletin AB-038 for information on determining heat sink requirements.

The mounting tab of the surface-mount package version should be soldered to a circuit board copper area for good heat dissipation. Figure 3 shows typical thermal resistance from junction to ambient as a function of the copper area.

THERMAL PROTECTION

The OPA544 has thermal shutdown that protects the amplifier from damage. Any tendency to activate the thermal shutdown circuit during normal operation is indication of excessive power dissipation or an inadequate heat sink.

The thermal protection activates at a junction temperature of approximately 155°C. For reliable operation, junction temperature should be limited to 150°C, maximum. To estimate the margin of safety in a complete design (including heat sink), increase the ambient temperature until the thermal protection is activated. Use worst-case load and signal conditions. For good reliability, the thermal protection should trigger more than 25°C above the maximum expected ambient condition of your application. This produces a junction temperature of 125°C at the maximum expected ambient condition.

Depending on load and signal conditions, the thermal protection circuit may produce a duty-cycle modulated output signal. This limits the dissipation in the amplifier, but the rapidly varying output waveform may be damaging to some loads. The thermal protection may behave differently depending on whether internal dissipation is produced by sourcing or sinking output current.

OUTPUT STAGE COMPENSATION

The complex load impedances common in power op amp applications can cause output stage instability. Figure 3 shows an output series R/C compensation network (1Ω in series with 0.01μF) which generally provides excellent stability. Some variation in circuit values may be required with certain loads.

UNBALANCED POWER SUPPLIES

Some applications do not require equal positive and negative output voltage swing. The power supply voltages of the OPA544 do not need to be equal. For example, a -6V negative power supply voltage assures that the inputs of the OPA544 are operated within their linear common-mode range, and that the output can swing to 0V. The V+ power supply could range from 15V to 65V. The total voltage (V- to V+) can range from 20V to 70V. With a 65V positive supply voltage, the device may not be protected from damage during short-circuits because of the larger V_{CE} during this condition.

OUTPUT PROTECTION

Reactive and EMF-generating loads can return load current to the amplifier, causing the output voltage to exceed the power supply voltage. This damaging condition can be avoided with clamp diodes from the output terminal to the power supplies as shown in Figure 4. Fast-recovery rectifier diodes with a 4A or greater continuous rating are recommended.

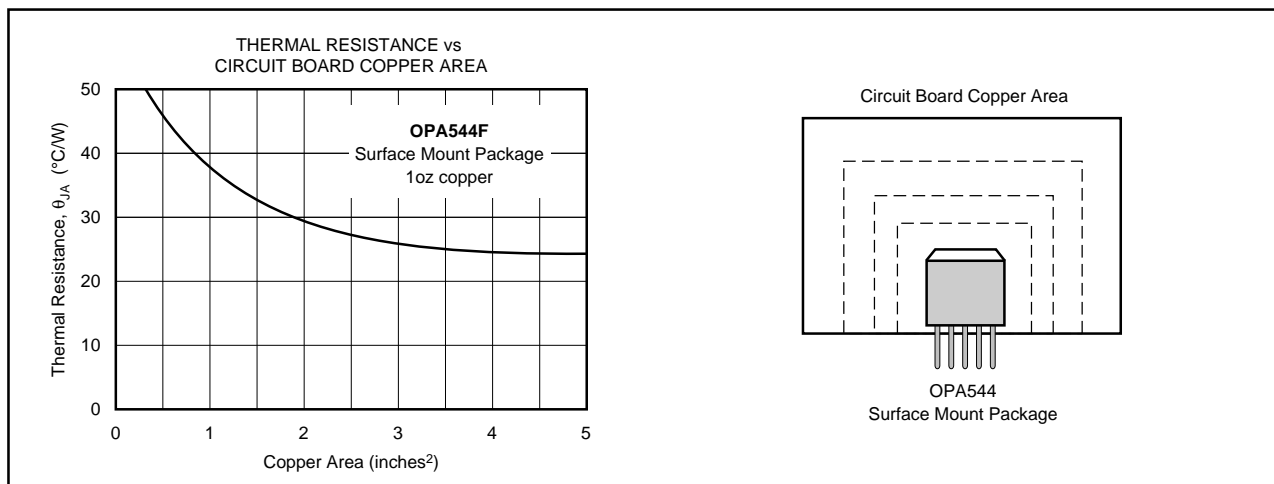

FIGURE 3. Thermal Resistance vs Circuit Board Copper Area.

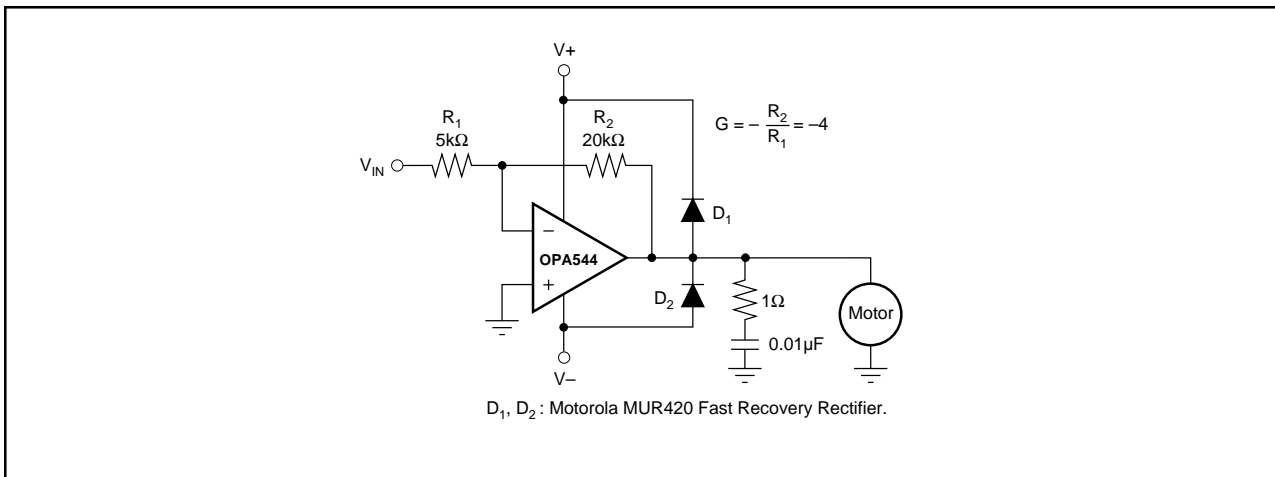

FIGURE 4. Motor Drive Circuit.

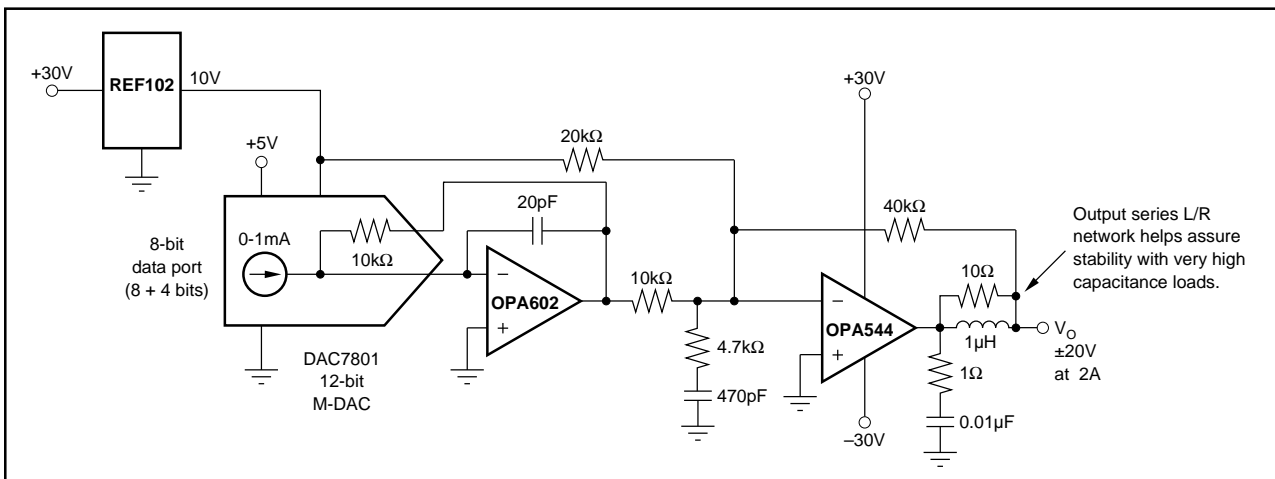

FIGURE 5. Digitally Programmable Power Supply.