



# ±80V Fault-Protected, 2Mbps, Low Supply Current CAN Transceivers

MAX3050/MAX3057

## General Description

The MAX3050/MAX3057 interface between the CAN protocol controller and the physical wires of the bus lines in a controller area network (CAN). They are primarily intended for automotive systems requiring data rates up to 2Mbps and feature ±80V fault protection against short circuits in high-voltage power buses. They provide differential transmit capability to the bus and differential receive capability to the CAN controller.

The MAX3050/MAX3057 have four modes of operation: high speed, slope control, standby, and shutdown. High-speed mode allows data rates up to 2Mbps. In slope-control mode, data rates are 40kbps to 500kbps, so the effects of EMI are reduced, and unshielded twisted or parallel cable can be used. In standby mode, the transmitters are shut off and the receivers are put into low-current mode. In shutdown mode, the transmitter and receiver are switched off.

The MAX3050 has an AutoShutdown™ function that puts the device into a 15µA shutdown mode when the bus or CAN controller is inactive for 4ms or longer.

The MAX3050/MAX3057 are available in an 8-pin SO package and are specified for operation from -40°C to +125°C.

## Applications

- Automotive Systems
- HVAC Controls
- Telecom 72V systems

*AutoShutdown is a trademark of Maxim Integrated Products, Inc.*

## Features

- ◆ ±80V Fault Protection for 42V Systems
- ◆ Four Operating Modes
  - High-Speed Operation Up to 2Mbps
  - Slope-Control Mode to Reduce EMI (40kbps to 500kbps)
  - Standby Mode
  - Low-Current Shutdown Mode
- ◆ AutoShutdown when Device Is Inactive (MAX3050)
- ◆ Automatic Wake-Up from Shutdown (MAX3050)
- ◆ Thermal Shutdown
- ◆ Current Limiting
- ◆ Fully Compatible with the ISO 11898 Standard\*

\* Pending completion of testing.

## Ordering Information

PART	TEMP RANGE	PIN-PACKAGE
MAX3050ASA	-40°C to +125°C	8 SO
MAX3057ASA	-40°C to +125°C	8 SO

## Pin Configuration

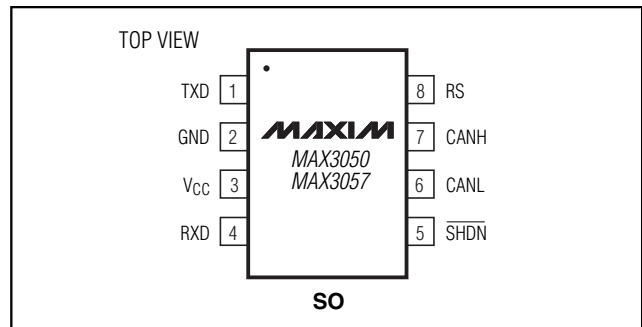

## Typical Operating Circuit

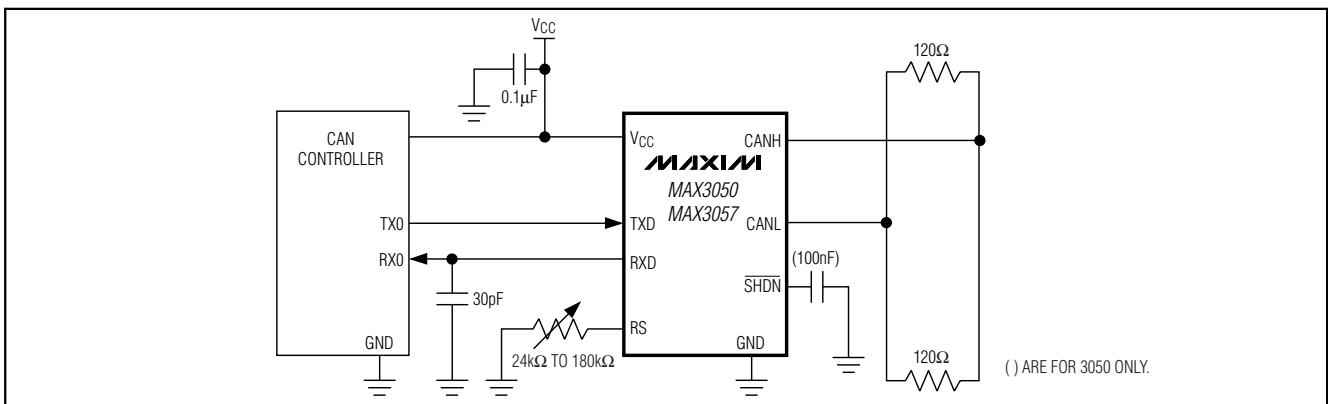

# ±80V Fault-Protected, 2Mbps, Low Supply Current CAN Transceivers

## ABSOLUTE MAXIMUM RATINGS

V <sub>CC</sub> to GND .....	-0.3V to +6V	Operating Temperature Range .....	-40°C to +125°C
TXD, RS, RXD, SHDN to GND .....	-0.3V to (V <sub>CC</sub> + 0.3V)	Junction Temperature .....	+150°C
CANH, CANL to GND .....	-80V to +80V	Storage Temperature Range .....	-65°C to +150°C
RXD Shorted to GND .....	Continuous	Lead Temperature (soldering, 10s) .....	+300°C
Continuous Power Dissipation (T <sub>A</sub> = +70°C)			
8-Pin SO (derate 5.9mW/°C above +70°C) .....	470mW		

Stresses beyond those listed under "Absolute Maximum Ratings" may cause permanent damage to the device. These are stress ratings only, and functional operation of the device at these or any other conditions beyond those indicated in the operational sections of the specifications is not implied. Exposure to absolute maximum rating conditions for extended periods may affect device reliability.

## DC ELECTRICAL CHARACTERISTICS

(V<sub>CC</sub> = +5V ±10%, R<sub>L</sub> = 60Ω, R<sub>S</sub> = GND, T<sub>A</sub> = T<sub>MIN</sub> to T<sub>MAX</sub>. Typical values are at V<sub>CC</sub> = +5V and T<sub>A</sub> = +25°C.)

PARAMETER	SYMBOL	CONDITIONS	MIN	TYP	MAX	UNITS
Supply Current	I <sub>S</sub>	Dominant (Note 1)		56	72	mA
		Dominant no load			6	
		Recessive (Note 1)		3.6	5.5	
		Recessive no load			5.5	
Quiescent Current Standby Mode	I <sub>Q</sub>	V <sub>RS</sub> = V <sub>CC</sub>		125	260	μA
Shutdown Supply Current	I <sub>QSHDN</sub>	$\overline{\text{SHDN}}$ = GND		15	30	μA
Thermal-Shutdown Threshold				160		°C
Thermal-Shutdown Hysteresis				20		°C
<b>TXD INPUT LEVELS</b>						
High-Level Input Voltage	V <sub>IH</sub>		2			V
Low-Level Input Voltage	V <sub>IL</sub>				0.4	V
High-Level Input Current	I <sub>IH</sub>	V <sub>TXD</sub> = V <sub>CC</sub>		1		μA
Pullup Resistor	R <sub>INTXD</sub>			20		kΩ
<b>CANH, CANL TRANSMITTER</b>						
Recessive Bus Voltage	V <sub>CANH</sub> , V <sub>CANL</sub>	V <sub>TXD</sub> = V <sub>CC</sub> , no load	2		3	V
Off-State Output Leakage	I <sub>LO</sub>	-2V < V <sub>CANH</sub> , V <sub>CANL</sub> < +7V $\overline{\text{SHDN}}$ = GND, V <sub>TXD</sub> = V <sub>CC</sub>	-2		+1	mA
		-80V < V <sub>CANH</sub> , V <sub>CANL</sub> < +80V $\overline{\text{SHDN}}$ = GND, V <sub>TXD</sub> = V <sub>CC</sub>	-4		+4	
CANH Output Voltage	V <sub>CANH</sub>	V <sub>TXD</sub> = 0	3.0		V <sub>CC</sub>	V
CANL Output Voltage	V <sub>CANL</sub>	V <sub>TXD</sub> = 0	0		2.0	V
Differential Output (V <sub>CANH</sub> - V <sub>CANL</sub> )	ΔV <sub>CANH</sub> , V <sub>CANL</sub>	V <sub>TXD</sub> = 0	1.5		5	V
		V <sub>TXD</sub> = 0, R <sub>L</sub> = 45Ω	1.5			
		V <sub>TXD</sub> = V <sub>CC</sub> , no load	-500		+50	mV
CANH Short-Circuit Current	I <sub>SC</sub>	V <sub>CANH</sub> = -5V	-200			mA
CANL Short-Circuit Current	I <sub>SC</sub>	V <sub>CANL</sub> = 18V			200	mA

# ±80V Fault-Protected, 2Mbps, Low Supply Current CAN Transceivers

**MAX3050/MAX3057**

## DC ELECTRICAL CHARACTERISTICS (continued)

(V<sub>CC</sub> = +5V ±10%, R<sub>L</sub> = 60Ω, R<sub>S</sub> = GND, T<sub>A</sub> = T<sub>MIN</sub> to T<sub>MAX</sub>. Typical values are at V<sub>CC</sub> = +5V and T<sub>A</sub> = +25°C.)

PARAMETER	SYMBOL	CONDITIONS	MIN	TYP	MAX	UNITS
<b>DC BUS RECEIVER</b> (V <sub>TXD</sub> = V <sub>CC</sub> ; CANH and CANL externally driven; -2V < V <sub>CANH</sub> , V <sub>CANL</sub> < +7V, unless otherwise specified)						
Differential Input Voltage (Recessive)	V <sub>DIFF</sub>	-7V < V <sub>CANH</sub> , V <sub>CANL</sub> < +12V	-1.0		+0.5	V
Differential Input Voltage (Dominant)	V <sub>DIFF</sub>	-7V < V <sub>CANH</sub> , V <sub>CANL</sub> < +12V	0.9		3.3	V
Differential Input Hysteresis	V <sub>DIFF(HYST)</sub>			150		mV
CANH Input Wake-Up Voltage Threshold	V <sub>CANH</sub> (SHDN)	$\overline{\text{SHDN}} = \text{GND}$ , V <sub>TXD</sub> = V <sub>CC</sub> (MAX3050)	6		9	V
RXD High-Level Output Voltage	V <sub>OH</sub>	I = -100μA	0.8 × V <sub>CC</sub>			V
RXD Low-Level Output Voltage	V <sub>OL</sub>	I = 10mA			0.8	V
		I = 5mA			0.4	
CANH and CANL Input Resistance	R <sub>I</sub>		5		25	kΩ
Differential Input Resistance	R <sub>DIFF</sub>		10		100	kΩ
<b>MODE SELECTION (RS)</b>						
Input Voltage for High Speed	V <sub>SLP</sub>				0.3 × V <sub>CC</sub>	V
Input Voltage for Standby	V <sub>STBY</sub>		0.75 × V <sub>CC</sub>			V
Slope-Control Mode Voltage	V <sub>SLOPE</sub>	R <sub>RS</sub> = 24kΩ to 180kΩ	0.4 × V <sub>CC</sub>		0.6 × V <sub>CC</sub>	V
Slope-Control Mode Current	I <sub>SLOPE</sub>	R <sub>RS</sub> = 24kΩ to 180kΩ	-200		-10	μA
Standby Mode	I <sub>STBY</sub>		-10		+10	μA
High-Speed Mode Current	I <sub>HS</sub>	V <sub>RS</sub> = 0			-500	μA
<b>SHUTDOWN</b>						
SHDN Input Pullup Resistor	R <sub>INSHDN</sub>	MAX3057	500		900	kΩ
SHDN Input Voltage High			2			V
SHDN Input Voltage Low					0.5	V

# ±80V Fault-Protected, 2Mbps, Low Supply Current CAN Transceivers

## TIMING CHARACTERISTICS

( $V_{CC} = +5V \pm 10\%$ ,  $R_L = 60\Omega$ ,  $C_L = 100pF$ ,  $T_A = T_{MIN}$  to  $T_{MAX}$ . Typical values are at  $V_{CC} = +5V$  and  $T_A = +25^\circ C$ .) (Figures 1, 2, and 3)

PARAMETER	SYMBOL	CONDITIONS	MIN	TYP	MAX	UNITS
<b>TIMING</b>						
Minimum Bit Time	t <sub>BIT</sub>	V <sub>RS</sub> = 0 (2Mbps)	0.5			μs
		R <sub>RS</sub> = 24kΩ (500kbps)	2			
		R <sub>RS</sub> = 100kΩ (125kbps)	8			
		R <sub>RS</sub> = 180kΩ (62.5kbps)	25			
Delay TXD to Bus Active	t <sub>ONTXD</sub>	V <sub>RS</sub> = 0			40	ns
Delay TXD to Bus Inactive	t <sub>OFFTXD</sub>	V <sub>RS</sub> = 0			75	ns
Delay TXD to Receiver Active	t <sub>ONRXD</sub>	V <sub>RS</sub> = 0 (2Mbps)			120	μs
		R <sub>RS</sub> = 24kΩ (500kbps)			0.4	
		R <sub>RS</sub> = 100kΩ (125kbps)			1.6	
		R <sub>RS</sub> = 180kΩ (62.5kbps)			5.0	
Delay TXD to Receiver Inactive	t <sub>OFFRXD</sub>	V <sub>RS</sub> = 0 (2Mbps)			130	μs
		R <sub>RS</sub> = 24kΩ (500kbps)			0.45	
		R <sub>RS</sub> = 100kΩ (125kbps)			1.6	
		R <sub>RS</sub> = 180kΩ (62.5kbps)			5.0	
Differential Output Slew Rate	SR	R <sub>RS</sub> = 24kΩ (500kbps)		14		V/μs
		R <sub>RS</sub> = 100kΩ (125kbps)		7		
		R <sub>RS</sub> = 180kΩ (62.5kbps)		1.6		
Bus Dominant to RXD Low		Standby mode			10	μs
Time to Wake Up: CANH > 9V	t <sub>WAKE</sub>	$\overline{SHDN} = GND$ , V <sub>TXD</sub> = V <sub>CC</sub> (MAX3050)			10	μs
Time to Sleep Mode when Bus Is Recessive	t <sub>SHDN</sub>	C <sub>SHDN</sub> = 100nF (MAX3050)	10		47	ms

**Note 1:** As defined by ISO, bus value is one of two complementary logical values: dominant or recessive. The dominant value represents the logical 1 and the recessive represents the logical 0. During the simultaneous transmission of the dominant and recessive bits, the resulting bus value is dominant. For MAX3050 and MAX3057 values, see the truth table in the *Transmitter* and *Receiver* sections.

# ±80V Fault-Protected, 2Mbps, Low Supply Current CAN Transceivers

**MAX3050/MAX3057**

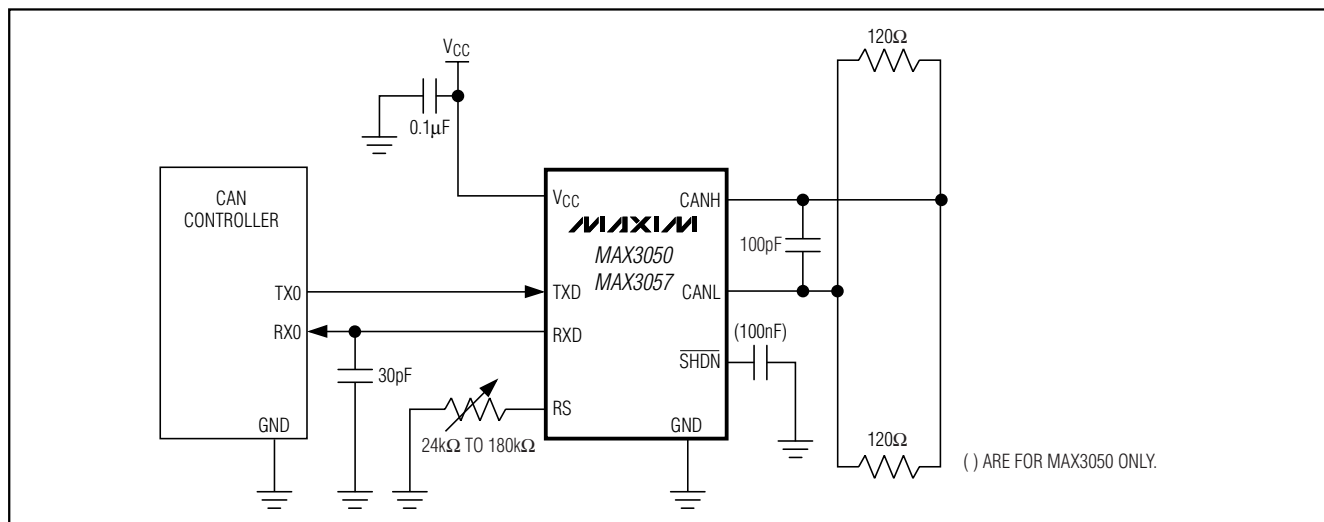

Figure 1. AC Test Circuit

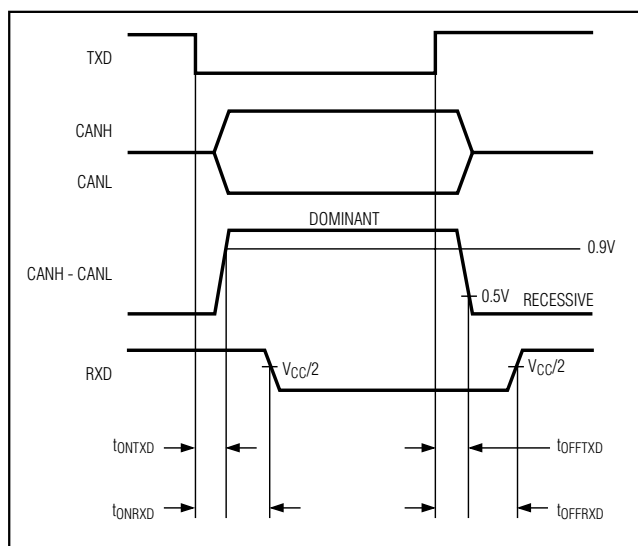

Figure 2. Timing Diagram for Dynamic Characteristics

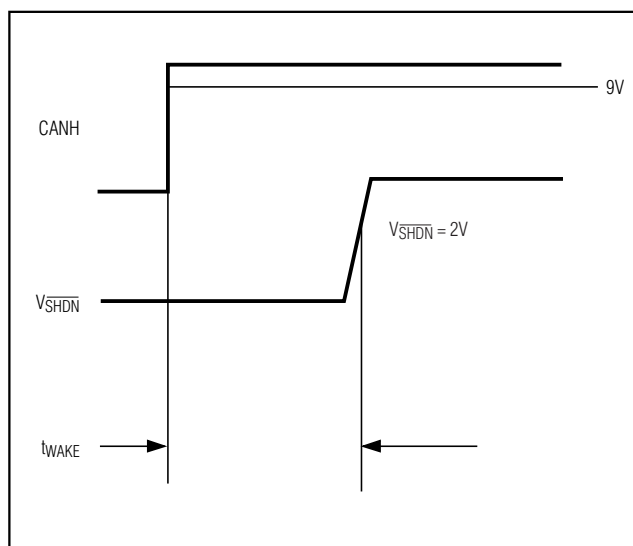
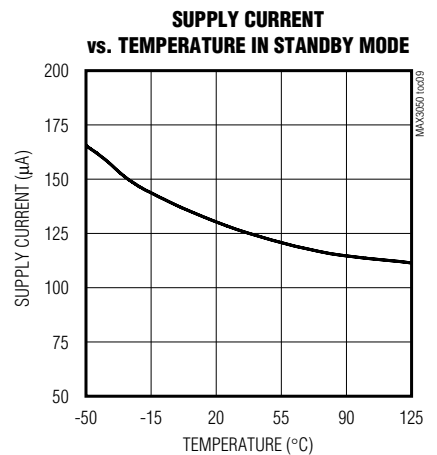
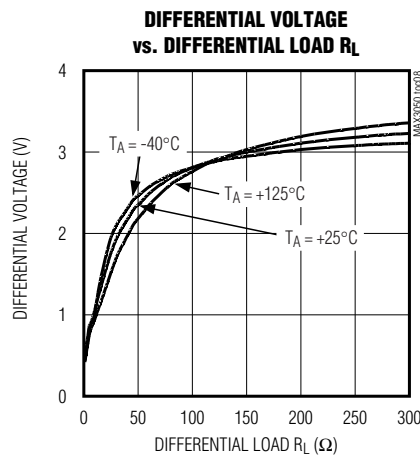
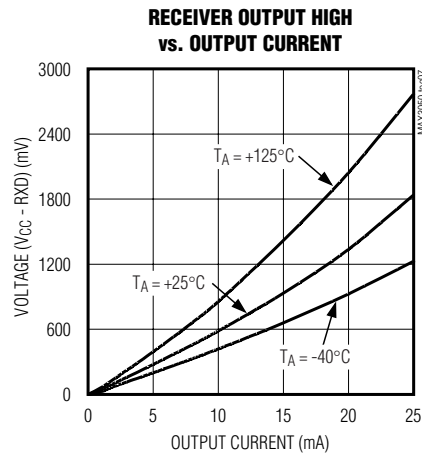
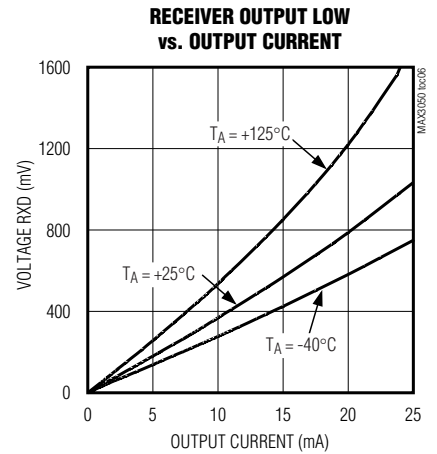
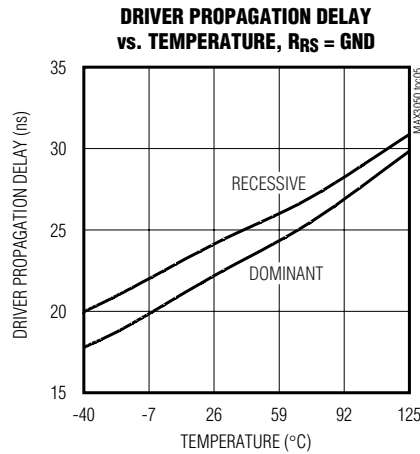
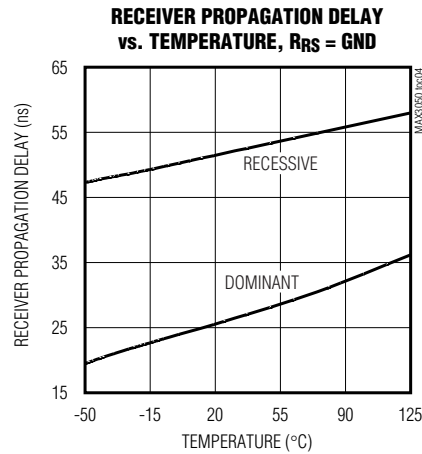
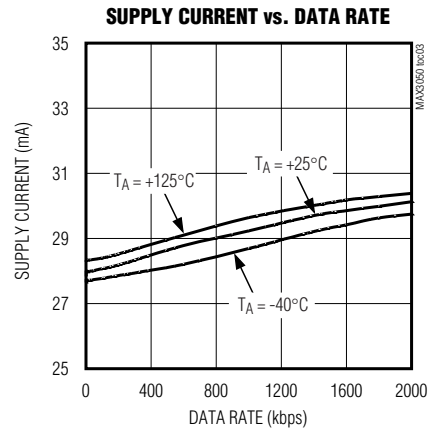
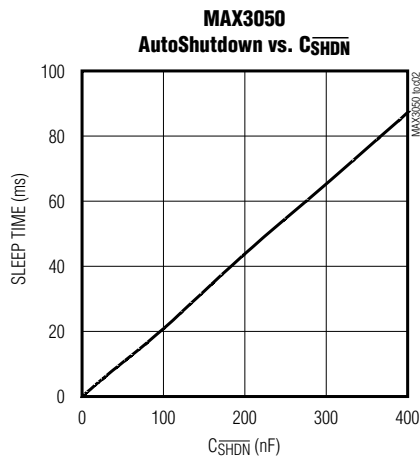
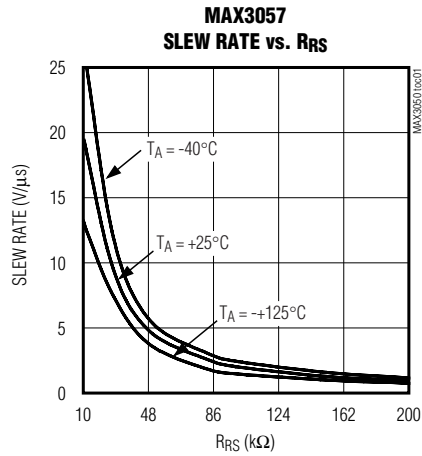

Figure 3. Time to Wake Up ( $t_{WAKE}$ ) (MAX3050)

# **±80V Fault-Protected, 2Mbps, Low Supply Current CAN Transceivers**

## **Typical Operating Characteristics**

( $V_{CC} = 5V$ ,  $R_L = 60\Omega$ ,  $C_L = 100pF$ ,  $T_A = +25^\circ C$ , unless otherwise specified.)



# ±80V Fault-Protected, 2Mbps, Low Supply Current CAN Transceivers

## Typical Operating Characteristics (continued)

( $V_{CC} = 5V$ ,  $R_L = 60\Omega$ ,  $C_L = 100pF$ ,  $T_A = +25^\circ C$ , unless otherwise specified.)

MAX3050/MAX3057

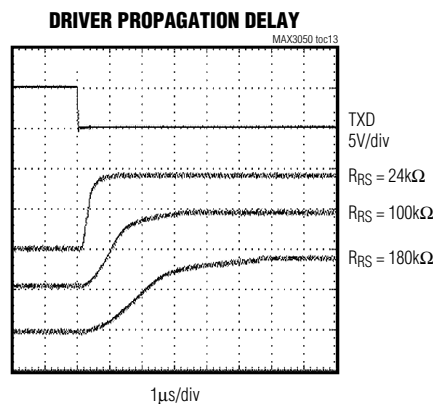
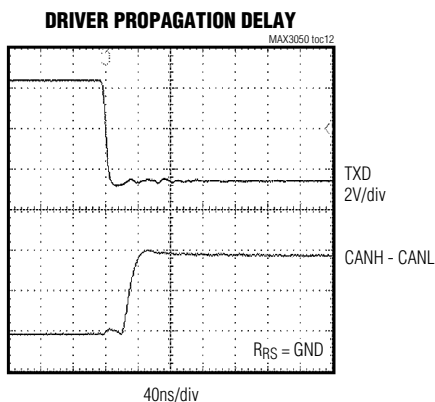
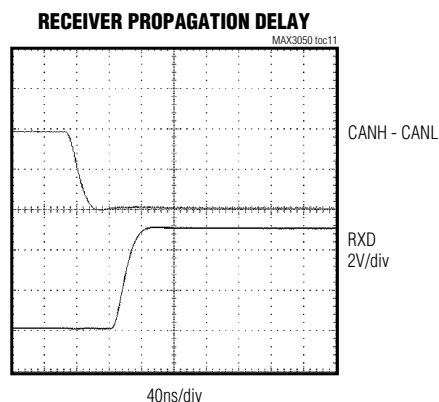
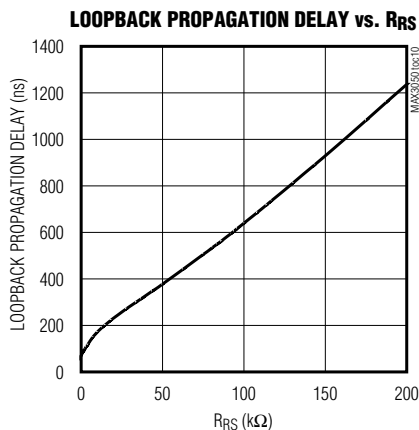

## Pin Description

PIN	NAME	FUNCTION
1	TXD	Transmit Data Input. TXD is a CMOS/TTL-compatible input from a CAN controller.
2	GND	Ground
3	$V_{CC}$	Supply Voltage. Bypass $V_{CC}$ to GND with a 0.1 $\mu$ F capacitor.
4	RXD	Receive Data Output. RXD is a CMOS/TTL-compatible output from the physical bus lines CANH and CANL.
5	$\overline{SHDN}$	Shutdown Input. Drive $\overline{SHDN}$ low to put into shutdown mode (MAX3057). Place a capacitor from $\overline{SHDN}$ to ground to utilize the AutoShutdown feature of MAX3050. See the <i>Shutdown</i> and <i>AutoShutdown</i> sections for a full explanation of $\overline{SHDN}$ behavior.
6	CANL	CAN Bus Line Low. CANL is fault protected to $\pm 80V$ .
7	CANH	CAN Bus Line High. CANH is fault protected to $\pm 80V$ .
8	RS	Mode Select Pin. Drive RS low or connect to GND for high-speed operation. Connect a resistor from RS to GND to control output slope. Drive RS high to put into standby mode. See the <i>Mode Selection</i> section.

# **$\pm 80V$ Fault-Protected, 2Mbps, Low Supply Current CAN Transceivers**

## **Detailed Description**

The MAX3050/MAX3057 interface between the protocol controller and the physical wires of the bus lines in a CAN. They are primarily intended for automotive applications requiring data rates up to 2Mbps and feature  $\pm 80V$  fault protection against shorts in high-voltage systems. This fault protection allows the devices to withstand up to  $\pm 80V$  with respect to ground with no damage to the device. The built-in fault tolerance allows the device to survive in industrial and automotive environments with no external protection devices. The devices provide differential transmit capability to the bus and differential receive capability to the CAN controller (Figure 4).

The device has four modes of operation: high speed, slope control, standby, and shutdown. In high-speed mode, slew rates are not limited, making 2Mbps transmission speeds possible. Slew rates are controlled in slope-control mode, minimizing EMI and allowing use of unshielded twisted or parallel cable. In standby mode, receivers are active and transmitters are in high impedance. In shutdown mode, transmitters and receivers are turned off.

The transceivers are designed to operate from a single +5V supply and draw 56mA of supply current in dominant state and 3.6mA in recessive state. In standby mode, supply current is reduced to 125 $\mu A$ . In shutdown mode, supply current is 15 $\mu A$ .

CANH and CANL are output short-circuit current limited and are protected against excessive power dissipation by thermal-shutdown circuitry that places the driver outputs into a high-impedance state.

## **Fault Protection**

The MAX3050/MAX3057 feature  $\pm 80V$  fault protection. This extended voltage range of CANH and CANL bus lines allows use in high-voltage systems and communication with high-voltage buses. If data is transmitting at 2Mbps, the fault protection is reduced to  $\pm 70V$ .

## **Transmitter**

The transmitter converts a single-ended input (TXD) from the CAN controller to differential outputs for the bus lines (CANH, CANL). The truth table for the transmitter and receiver is given in Table 1.

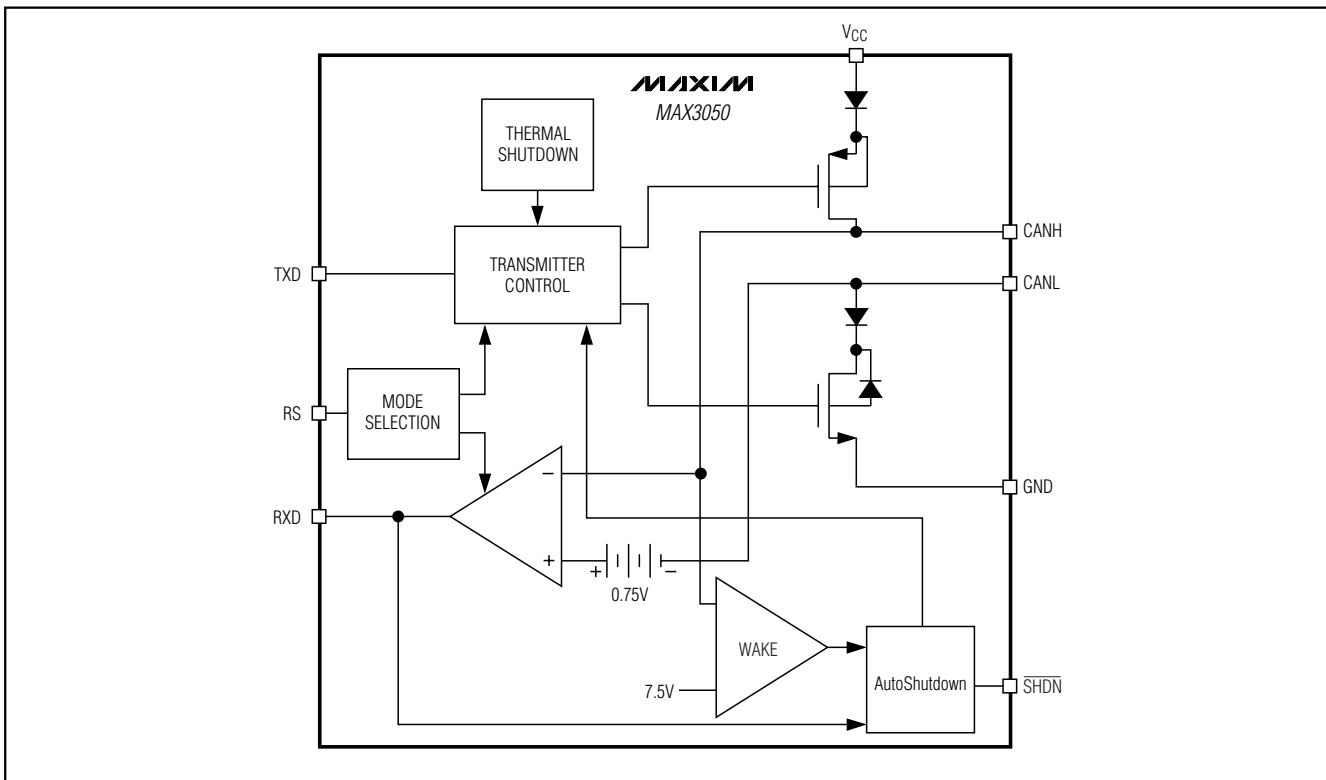

Figure 4. Functional Diagram



# ±80V Fault-Protected, 2Mbps, Low Supply Current CAN Transceivers

MAX3050/MAX3057

**Table 1. Transmitter and Receiver Truth Table**

TXD	RS	$\overline{\text{SHDN}}$	CANH	CANL	BUS STATE	RXD
0	$V_{RS} < 0.75 \times V_{CC}$	$V_{\overline{\text{SHDN}}} > 1.5V$	High	Low	Dominant*	0
1 or float	$V_{RS} < 0.75 \times V_{CC}$	$V_{\overline{\text{SHDN}}} > 1.5V$	5kΩ to 25kΩ to $V_{CC}/2$	5kΩ to 25kΩ to $V_{CC}/2$	Recessive*	1
X	$V_{RS} > 0.75 \times V_{CC}$	X	Floating	Floating	Floating	1
X	X	$V_{\overline{\text{SHDN}}} < 0.5V$	Floating	Floating	Floating	1

X = Don't care.

\*As defined by ISO, bus value is one of two complementary logical values: dominant or recessive. The dominant value represents the logical 0 and the recessive represents the logical 1. During the simultaneous transmission of the dominant and recessive bits, the resulting bus value is dominant.

### High Speed

Connect RS to ground to set the MAX3050/MAX3057 to high-speed mode. When operating in high-speed mode, the MAX3050/MAX3057 can achieve transmission rates of up to 2Mbps. Line drivers are switched on and off as quickly as possible. However, in this mode, no measures are taken to limit the rise and fall slope of the data signal, allowing for potential EMI emissions. If using the MAX3050/MAX3057 in high-speed mode, use shielded twisted-pair cable to avoid EMI problems.

### Slope Control

Connect a resistor from RS to ground to select slope-control mode (Table 2). In slope-control mode, the gates of the line drivers are charged with a controlled current, proportional to the resistor connected to the RS pin. Transmission speed ranges from 40kbps to 500kbps. Controlling the rise and fall slope reduces EMI and allows the use of an unshielded twisted pair or a parallel pair of wires as bus lines. The transfer function for selecting the resistor value is given by:

$$R_{RS} \text{ (k}\Omega\text{)} = 12000/\text{speed (in kbps)}$$

See the Slew Rate vs.  $R_{RS}$  graph in the *Typical Operating Characteristics* section.

### Receiver

The receiver reads differential input from the bus lines (CANH, CANL) and transfers this data as a single-ended output (RXD) to the CAN controller. It consists of a comparator that senses the difference  $\Delta V = (\text{CANH} - \text{CANL})$  with respect to an internal threshold of 0.7V. If this difference is positive (i.e.,  $\Delta V > 0.7V$ ), a logic low is

present at the RXD pin. If negative (i.e.,  $\Delta V < 0.7V$ ), a logic high is present.

The receiver always echoes the transmitted data.

The CANH and CANL common-mode range is -7V to +12V. RXD is logic high when CANH and CANL are shorted or terminated and undriven. If the differential receiver input voltage (CANH - CANL) is less than or equal to 0.5V, RXD is logic high. If (CANH - CANL) is greater than or equal to 0.9V, RXD is logic low.

### Standby

If a logic high level is applied to RS, the MAX3050/MAX3057 enter a low-current standby mode. In this mode, the transmitter is switched off and the receiver is switched to a low-current state. If dominant bits are detected, RXD switches to a low level. The microcontroller should react to this condition by switching the transceiver back to normal operation (through RS). Due to the reduced power mode, the receiver is slower in standby mode, and the first message may be lost at higher bit rates.

### Thermal Shutdown

If the junction temperature exceeds +160°C, the device is switched off. The hysteresis is approximately 20°C, disabling thermal shutdown once the temperature reaches +140°C.

### Shutdown (MAX3057)

Drive  $\overline{\text{SHDN}}$  low to enter shutdown mode. In shutdown mode, the device is switched off. The outputs are high impedance to ±80V. The MAX3057 features a pullup to  $\overline{\text{SHDN}}$ . If shutdown is forced low and then left floating, the device switches back to normal operating mode.

**Table 2. Mode Selection Truth Table**

CONDITION FORCED AT PIN RS	MODE	RESULTING CURRENT AT RS
$V_{RS} < 0.3 \times V_{CC}$	High speed	$ I_{RS}  < 500\mu\text{A}$
$0.4 \times V_{CC} < V_{RS} < 0.6 \times V_{CC}$	Slope control	$10\mu\text{A} <  I_{RS}  < 200\mu\text{A}$
$V_{RS} > 0.75 \times V_{CC}$	Standby	$ I_{RS}  < 10\mu\text{A}$

# ±80V Fault-Protected, 2Mbps, Low Supply Current CAN Transceivers

## AutoShutdown (MAX3050)

To manage power consumption, AutoShutdown puts the device into shutdown mode after the device has been inactive for a period of time. The value of an external capacitor ( $C_{\overline{\text{SHDN}}}$ ) connected to  $\overline{\text{SHDN}}$  determines the threshold of inactivity time, after which the AutoShutdown triggers. Floating  $\overline{\text{SHDN}}$  allows the MAX3050 to automatically change from active mode to shutdown.

Use a 100nF capacitor as  $C_{\overline{\text{SHDN}}}$  for a typical threshold of 20ms. Change the capacitor value according to the following equation to change the threshold time period.

$$C_{\overline{\text{SHDN}}}(\text{nF}) = \frac{0.02 \times \text{time}(\mu\text{s})}{(V_{\text{CC}} - V_{\overline{\text{SHDN}}})}$$

$V_{\overline{\text{SHDN}}}$  is the threshold of  $\overline{\text{SHDN}}$  guaranteed to be less than 2V in the *Electrical Characteristics* table. Drive  $\overline{\text{SHDN}}$  high to turn the MAX3050 on and disable AutoShutdown.

When the MAX3050 is in shutdown mode, only the wake-up comparator is active, and normal bus communication is ignored. The remote master of the CAN system wakes up the MAX3050 with a signal greater than 9V on CANH. Internal circuitry in the MAX3050 puts the device in normal operation by driving  $\overline{\text{SHDN}}$  high.

The MAX3057 does not have the AutoShutdown feature.

## Driver Output Protection

The MAX3050/MAX3057 have several features that protect them from damage. Thermal shutdown switches off the device and puts CANH and CANL into high impedance if the junction temperature exceeds +160°C. Thermal protection is needed particularly when a bus line is short circuited. The hysteresis for the thermal shutdown is approximately 20°C.

Additionally, a current-limiting circuit protects the transmitter output stage against short-circuits to positive and negative battery voltage. Although the power dissipation increases during this fault condition, this feature prevents destruction of the transmitter output stage.

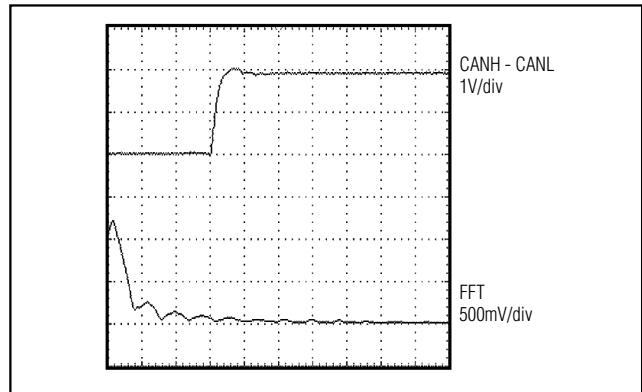

Figure 5. FFT Dominant Bus at 2Mbps

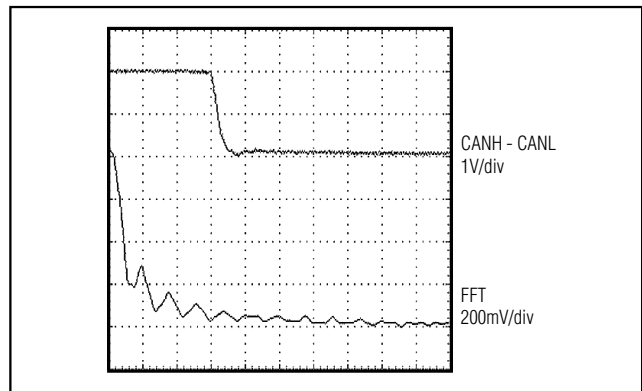

Figure 6. FFT Recessive Bus at 2Mbps

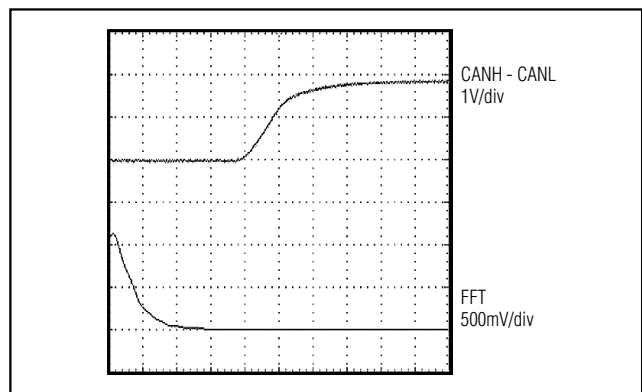

Figure 7. FFT Dominant Bus at 500kbps

# ±80V Fault-Protected, 2Mbps, Low Supply Current CAN Transceivers

MAX3050/MAX3057

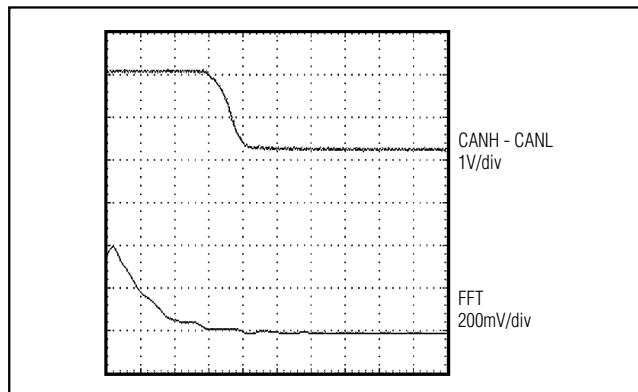

Figure 8. FFT Recessive Bus at 500kbps

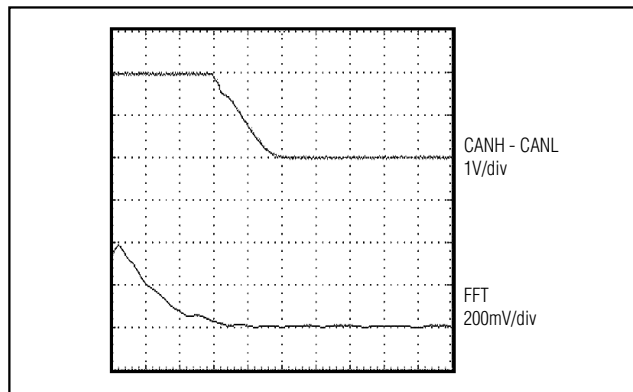

Figure 10. FFT Recessive Bus at 62.5kbps

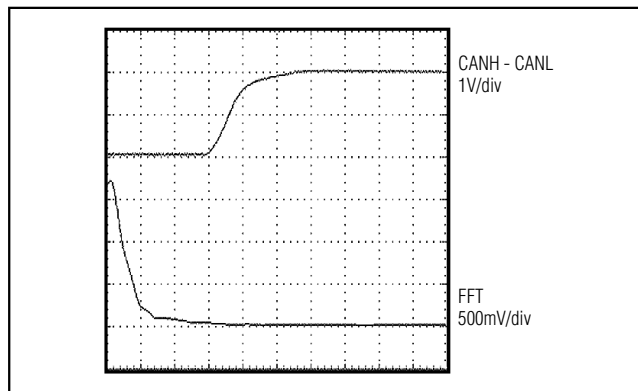

Figure 9. FFT Dominant Bus at 62.5kbps

## Applications Information

### Reduced EMI and Reflections

In slope-control mode, the CANH and CANL outputs are slew-rate limited, minimizing EMI and reducing reflections caused by improperly terminated cables. In general, a transmitter's rise time relates directly to the length of an unterminated stub, which can be driven with only minor waveform reflections. The following equation expresses this relationship conservatively:

$$\text{Length} = t_{\text{RISE}} / (15\text{ns/ft})$$

where  $t_{\text{RISE}}$  is the transmitter's rise time.

The MAX3050 and MAX3057 require no special layout considerations beyond common practices. Bypass  $V_{\text{CC}}$  to GND with a 0.1 $\mu\text{F}$  ceramic capacitor mounted close to the IC with short lead lengths and wide trace widths.

## Chip Information

TRANSISTOR COUNT: 1214

PROCESS: BiCMOS

# **±80V Fault-Protected, 2Mbps, Low Supply Current CAN Transceivers**

## **Package Information**

(The package drawing(s) in this data sheet may not reflect the most current specifications. For the latest package outline information, go to [www.maxim-ic.com/packages](http://www.maxim-ic.com/packages).)

SOICN, EPS

DIM	INCHES		MILLIMETERS	
	MIN	MAX	MIN	MAX
A	0.053	0.069	1.35	1.75
A1	0.004	0.010	0.10	0.25
B	0.014	0.019	0.35	0.49
C	0.007	0.010	0.19	0.25
e	0.050 BSC		1.27 BSC	
E	0.150	0.157	3.80	4.00
H	0.228	0.244	5.80	6.20
L	0.016	0.050	0.40	1.27

VARIATIONS:

DIM	INCHES		MILLIMETERS		N	MS012
	MIN	MAX	MIN	MAX		
D	0.189	0.197	4.80	5.00	8	AA
D	0.337	0.344	8.55	8.75	14	AB
D	0.386	0.394	9.80	10.00	16	AC

**NOTES:**

1. D&E DO NOT INCLUDE MOLD FLASH.
2. MOLD FLASH OR PROTRUSIONS NOT TO EXCEED 0.15mm (.006").
3. LEADS TO BE COPLANAR WITHIN 0.10mm (.004").
4. CONTROLLING DIMENSION: MILLIMETERS.
5. MEETS JEDEC MS012.
6. N = NUMBER OF PINS.

**DALLAS SEMICONDUCTOR** **MAXIM**

PROPRIETARY INFORMATION

TITLE: PACKAGE OUTLINE, .150" SOIC

APPROVAL	DOCUMENT CONTROL NO. 21-0041	REV. B	1/1
----------	---------------------------------	-----------	-----

Maxim cannot assume responsibility for use of any circuitry other than circuitry entirely embodied in a Maxim product. No circuit patent licenses are implied. Maxim reserves the right to change the circuitry and specifications without notice at any time.

12 \_\_\_\_\_ **Maxim Integrated Products, 120 San Gabriel Drive, Sunnyvale, CA 94086 408-737-7600**