



The Infinite Bandwidth Company™

# MIC5209

## 500mA Low-Noise LDO Regulator

### General Description

The MIC5209 is an efficient linear voltage regulator with very low dropout voltage, typically 10mV at light loads and less than 500mV at full load, with better than 1% output voltage accuracy.

Designed especially for hand-held, battery-powered devices, the MIC5209 features low ground current to help prolong battery life. An enable/shutdown pin on SO-8 and TO-263-5 versions can further improve battery life with near-zero shutdown current.

Key features include reversed-battery protection, current limiting, overtemperature shutdown, ultra-low-noise capability (SO-8 and TO-263-5 versions), and availability in thermally efficient packaging. The MIC5209 is available in adjustable or fixed output voltages.

*For space-critical applications where peak currents do not exceed 500mA, see the MIC5219.*

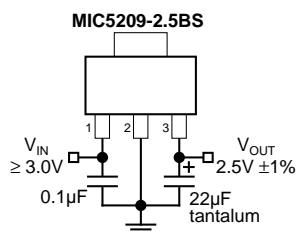
### Features

- Meets Intel® Slot 1 and Slot 2 requirements
- Guaranteed 500mA output over the full operating temperature range
- Low 500mV maximum dropout voltage at full load
- Extremely tight load and line regulation
- Thermally-efficient surface-mount package
- Low temperature coefficient
- Current and thermal limiting
- Reversed-battery protection
- No-load stability
- 1% output accuracy
- Ultra-low-noise capability in SO-8 and TO-263-5

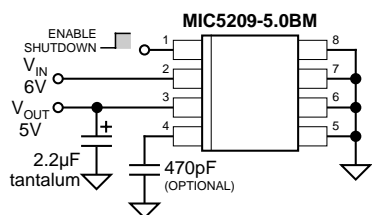
### Applications

- Pentium II Slot 1 and Slot 2 support circuits
- Laptop, notebook, and palmtop computers
- Cellular telephones
- Consumer and personal electronics
- SMPS post-regulator/dc-to-dc modules
- High-efficiency linear power supplies

### Typical Applications



**3.3V Nominal-Input Slot-1 Power Supply**

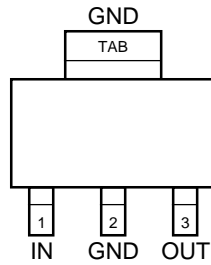


**Ultra-Low-Noise 5V Regulator**

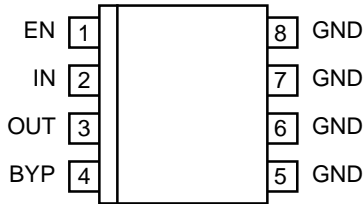
### Ordering Information

Part Number	Voltage	Junct. Temp. Range	Package
MIC5209-2.5BS	2.5V	-40°C to +125°C	SOT-223
MIC5209-3.0BS	3.0V	-40°C to +125°C	SOT-223
MIC5209-3.3BS	3.3V	-40°C to +125°C	SOT-223
MIC5209-3.6BS	3.6V	-40°C to +125°C	SOT-223
MIC5209-4.2BS	4.2V	-40°C to +125°C	SOT-223
MIC5209-5.0BS	5.0V	-40°C to +125°C	SOT-223
MIC5209-1.8BM	1.8V	0°C to +125°C	SO-8
MIC5209-2.5BM	2.5V	-40°C to +125°C	SO-8
MIC5209-3.0BM	3.0V	-40°C to +125°C	SO-8
MIC5209-3.3BM	3.3V	-40°C to +125°C	SO-8
MIC5209-3.6BM	3.6V	-40°C to +125°C	SO-8
MIC5209-5.0BM	5.0V	-40°C to +125°C	SO-8
MIC5209BM	Adj.	-40°C to +125°C	SO-8
MIC5209-2.5BU	2.5V	-40°C to +125°C	TO-263-5
MIC5209-3.0BU	3.0V	-40°C to +125°C	TO-263-5
MIC5209-3.3BU	3.3V	-40°C to +125°C	TO-263-5
MIC5209-3.6BU	3.6V	-40°C to +125°C	TO-263-5
MIC5209-5.0BU	5.0V	-40°C to +125°C	TO-263-5
MIC5209BU	Adj.	-40°C to +125°C	TO-263-5

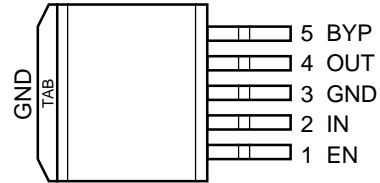
## Pin Configuration



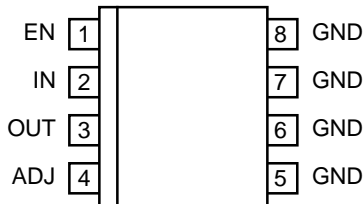
**MIC5209-x.xBS**  
SOT-223  
Fixed Voltages



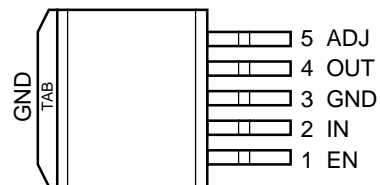
**MIC5209-x.xBM**  
SO-8  
Fixed Voltages



**MIC5209-x.xBU**  
TO-263-5  
Fixed Voltages



**MIC5209BM**  
SO-8  
Adjustable Voltage



**MIC5209BU**  
TO-263-5  
Adjustable Voltage

## Pin Description

Pin No. SOT-223	Pin No. SO-8	Pin No. TO-263-5	Pin Name	Pin Function
1	2	2	IN	Supply Input
2, TAB	5-8	3	GND	Ground: SOT-223 pin 2 and TAB are internally connected. SO-8 pins 5 through 8 are internally connected.
3	3	4	OUT	Regulator Output
	1	1	EN	Enable (Input): CMOS compatible control input. Logic high = enable; logic low or open = shutdown.
	4 (fixed)	5 (fixed)	BYP	Reference Bypass: Connect external 470pF capacitor to GND to reduce output noise. May be left open. For 1.8V or 2.5V operation, see "Applications Information."
	4 (adj.)	5 (adj.)	ADJ	Adjust (Input): Feedback input. Connect to resistive voltage-divider network.

**Absolute Maximum Ratings (Note 1)**

Supply Input Voltage ( $V_{IN}$ )	–20V to +20V
Power Dissipation ( $P_D$ )	Internally Limited, <b>Note 3</b>
Junction Temperature ( $T_J$ )	
all except 1.8V	–40°C to +125°C
1.8V only	0°C to +125°C
Lead Temperature (soldering, 5 sec.)	260°C
Storage Temperature ( $T_S$ )	–65°C to +150°C

**Operating Ratings (Note 2)**

Supply Input Voltage ( $V_{IN}$ )	+2.5V to +16V
Enable Input Voltage ( $V_{EN}$ )	0V to $V_{IN}$
Junction Temperature ( $T_J$ )	
all except 1.8V	–40°C to +125°C
1.8V only	0°C to +125°C
Package Thermal Resistance	<b>Note 3</b>

**Electrical Characteristics**

$V_{IN} = V_{OUT} + 1.0V$ ;  $C_{OUT} = 4.7\mu F$ ,  $I_{OUT} = 100\mu A$ ;  $T_J = 25^\circ C$ , **bold** values indicate  $-40^\circ C \leq T_J \leq +125^\circ C$  except  $0^\circ C \leq T_J \leq +125^\circ C$  for 1.8V version; unless noted.

Symbol	Parameter	Conditions	Min	Typical	Max	Units
$V_{OUT}$	Output Voltage Accuracy	variation from nominal $V_{OUT}$	–1 –2		1 2	% %
$\Delta V_{OUT}/\Delta T$	Output Voltage Temperature Coefficient	<b>Note 4</b>		<b>40</b>		ppm/°C
$\Delta V_{OUT}/V_{OUT}$	Line Regulation	$V_{IN} = V_{OUT} + 1V$ to 16V		0.009	0.05 <b>0.1</b>	%/V %/V
$\Delta V_{OUT}/V_{OUT}$	Load Regulation	$I_{OUT} = 100\mu A$ to 500mA, <b>Note 5</b>		0.05	0.5 <b>0.7</b>	% %
$V_{IN} - V_{OUT}$	Dropout Voltage, <b>Note 6</b>	$I_{OUT} = 100\mu A$		10	60 <b>80</b>	mV mV
		$I_{OUT} = 50mA$		115	175 <b>250</b>	mV mV
		$I_{OUT} = 150mA$		165	300 <b>400</b>	mV mV
		$I_{OUT} = 500mA$		350	500 <b>600</b>	mV mV
$I_{GND}$	Ground Pin Current, <b>Notes 7, 8</b>	$V_{EN} \geq 3.0V$ , $I_{OUT} = 100\mu A$		80	130 <b>170</b>	$\mu A$ $\mu A$
		$V_{EN} \geq 3.0V$ , $I_{OUT} = 50mA$		350	650 <b>900</b>	$\mu A$ $\mu A$
		$V_{EN} \geq 3.0V$ , $I_{OUT} = 150mA$		1.8	2.5 <b>3.0</b>	mA mA
		$V_{EN} \geq 3.0V$ , $I_{OUT} = 500mA$		8	20 <b>25</b>	mA mA
$I_{GND}$	Ground Pin Quiescent Current, <b>Note 8</b>	$V_{EN} \leq 0.4V$ (shutdown)		0.05	<b>3</b>	$\mu A$
		$V_{EN} \leq 0.18V$ (shutdown)		0.10	<b>8</b>	$\mu A$
PSRR	Ripple Rejection	$f = 120Hz$		75		dB
$I_{LIMIT}$	Current Limit	$V_{OUT} = 0V$		700	900 <b>1000</b>	mA mA
$\Delta V_{OUT}/\Delta P_D$	Thermal Regulation	<b>Note 9</b>		0.05		%/W
$e_{no}$	Output Noise <b>Note 10</b>	$V_{OUT} = 2.5V$ , $I_{OUT} = 50mA$ , $C_{OUT} = 2.2\mu F$ , $C_{BYP} = 0$		500		nV/ $\sqrt{Hz}$
		$I_{OUT} = 50mA$ , $C_{OUT} = 2.2\mu F$ , $C_{BYP} = 470pF$		300		nV/ $\sqrt{Hz}$

**ENABLE Input**

$V_{ENL}$	Enable Input Logic-Low Voltage	$V_{EN} = \text{logic low (regulator shutdown)}$			0.4 <b>0.18</b>	V V
		$V_{EN} = \text{logic high (regulator enabled)}$	2.0			V
$I_{ENL}$	Enable Input Current	$V_{ENL} \leq 0.4V$		0.01	-1	$\mu A$
		$V_{ENL} \leq 0.18V$		<b>0.01</b>	<b>-2</b>	$\mu A$
$I_{ENH}$		$V_{ENH} \geq 2.0V$		5	20 <b>25</b>	$\mu A$ $\mu A$

**Note 1.** Exceeding the absolute maximum rating may damage the device.

**Note 2.** The device is not guaranteed to function outside its operating rating.

**Note 3:** The maximum allowable power dissipation at any  $T_A$  (ambient temperature) is calculated using:  $P_{D(max)} = (T_{J(max)} - T_A) \div \theta_{JA}$ . Exceeding the maximum allowable power dissipation will result in excessive die temperature, and the regulator will go into thermal shutdown. See Table 1 and the "Thermal Considerations" section for details.

**Note 4:** Output voltage temperature coefficient is the worst case voltage change divided by the total temperature range.

**Note 5:** Regulation is measured at constant junction temperature using low duty cycle pulse testing. Parts are tested for load regulation in the load range from 100 $\mu A$  to 500mA. Changes in output voltage due to heating effects are covered by the thermal regulation specification.

**Note 6:** Dropout voltage is defined as the input to output differential at which the output voltage drops 2% below its nominal value measured at 1V differential.

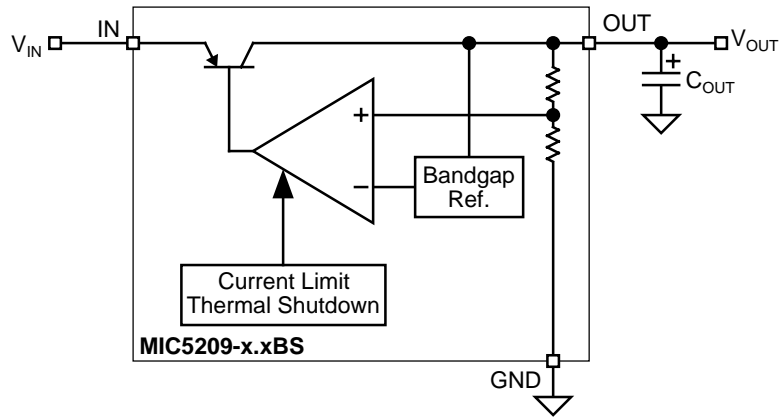
**Note 7:** Ground pin current is the regulator quiescent current plus pass transistor base current. The total current drawn from the supply is the sum of the load current plus the ground pin current.

**Note 8:**  $V_{EN}$  is the voltage externally applied to devices with the EN (enable) input pin. [SO-8 (M) and TO-263-5 (U) packages only.]

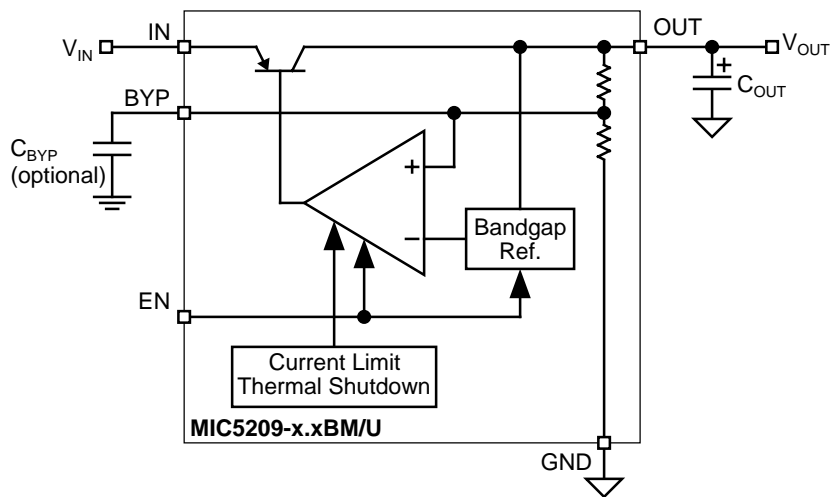
**Note 9:** Thermal regulation is the change in output voltage at a time "t" after a change in power dissipation is applied, excluding load or line regulation effects. Specifications are for a 500mA load pulse at  $V_{IN} = 16V$  for  $t = 10ms$ .

**Note 10:**  $C_{BYP}$  is an optional, external bypass capacitor connected to devices with a BYP (bypass) or ADJ (adjust) pin. [SO-8 (M) and TO-263-5 (U) packages only].

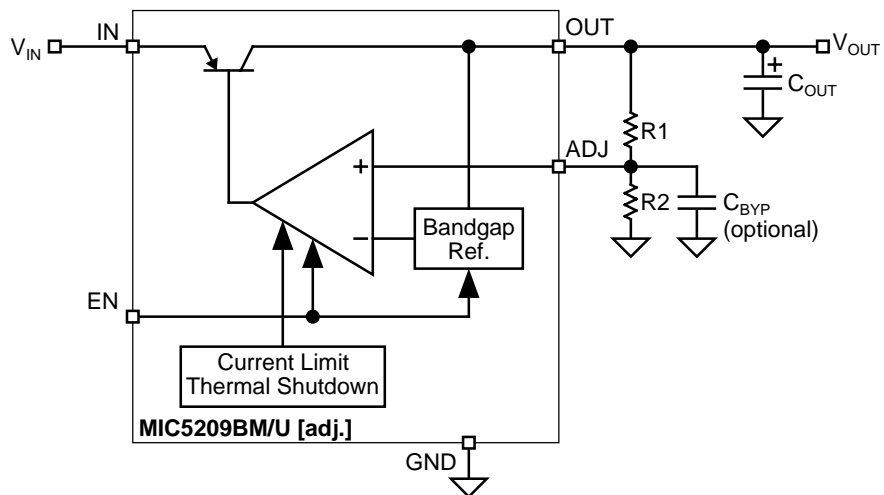
**Block Diagrams**



**Low-Noise Fixed Regulator (SOT-223 version only)**

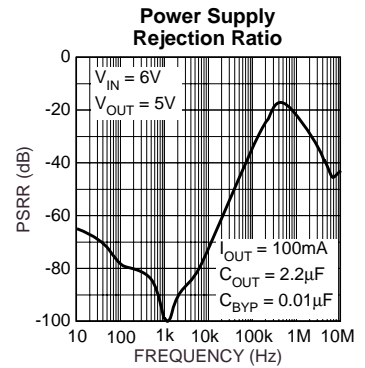
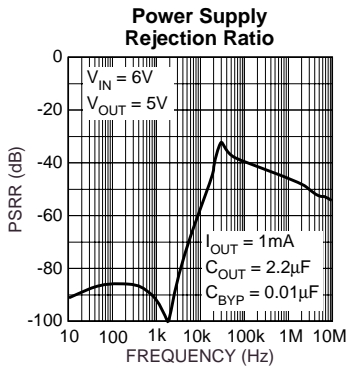
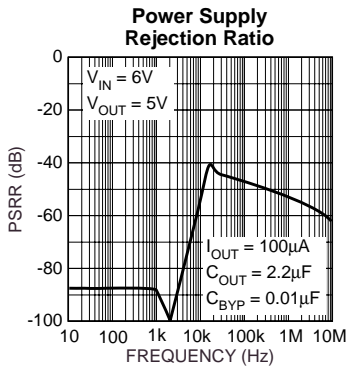
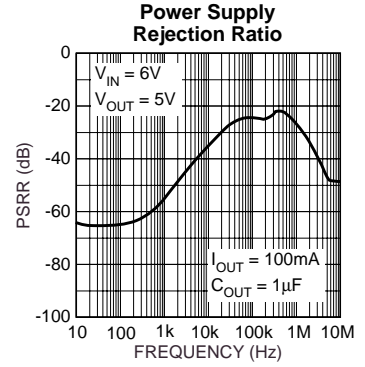
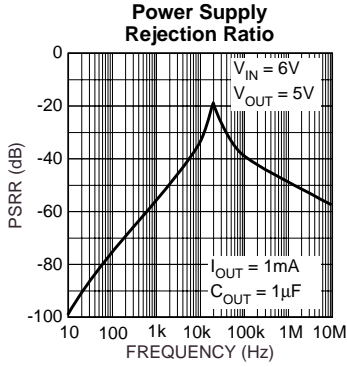
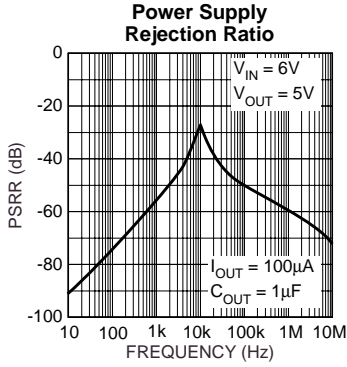


**Ultra-Low-Noise Fixed Regulator**

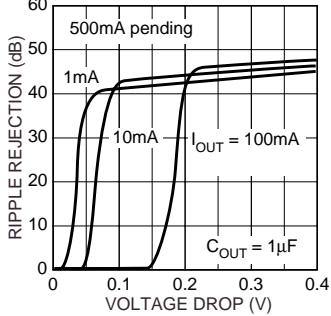


**Ultra-Low-Noise Adjustable Regulator**

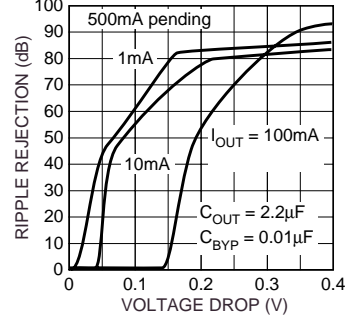
# Typical Characteristics



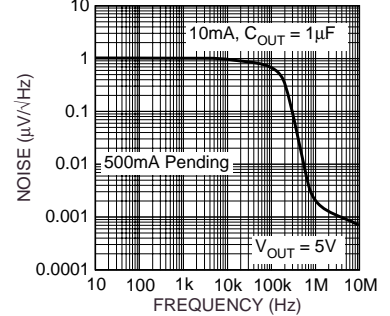
Power Supply Ripple Rejection vs. Voltage Drop



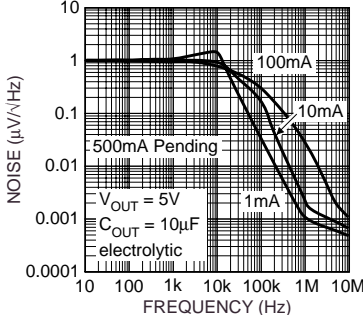
Power Supply Ripple Rejection vs. Voltage Drop



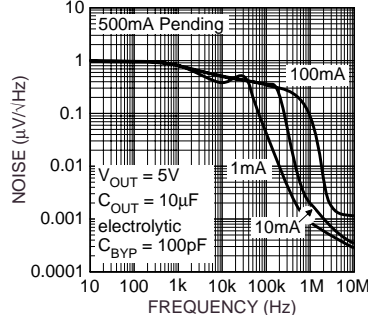
Noise Performance



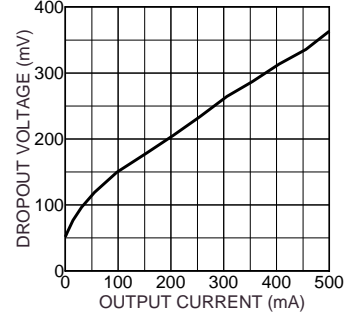
Noise Performance



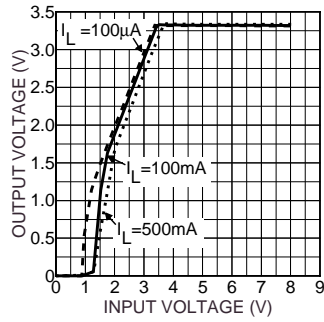
Noise Performance



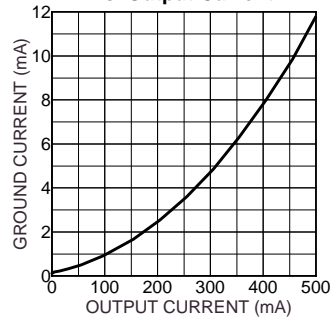
Dropout Voltage vs. Output Current



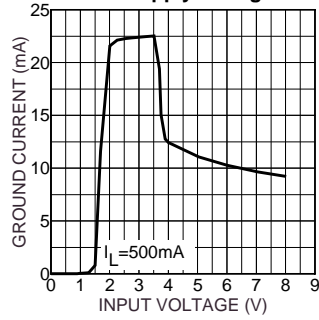
**Dropout Characteristics**



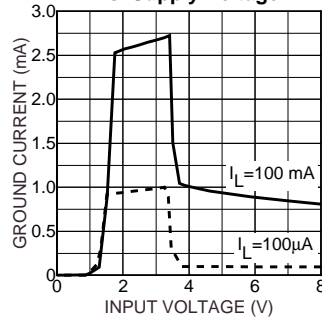
**Ground Current vs. Output Current**



**Ground Current vs. Supply Voltage**



**Ground Current vs. Supply Voltage**



## Applications Information

### Enable/Shutdown

Enable is available only on devices in the SO-8 (M) and TO-263-5 (U) packages.

Forcing EN (enable/shutdown) high ( $> 2V$ ) enables the regulator. EN is compatible with CMOS logic. If the enable/shutdown feature is not required, connect EN to IN (supply input).

### Input Capacitor

A  $1\mu F$  capacitor should be placed from IN to GND if there is more than 10 inches of wire between the input and the ac filter capacitor or if a battery is used as the input.

### Output Capacitor

An output capacitor is required between OUT and GND to prevent oscillation. The minimum size of the output capacitor is dependent upon whether a reference bypass capacitor is used.  $1\mu F$  minimum is recommended when  $C_{BYP}$  is not used (see Figure 1).  $2.2\mu F$  minimum is recommended when  $C_{BYP}$  is  $470pF$  (see Figure 2). Larger values improve the regulator's transient response.

The output capacitor should have an ESR (equivalent series resistance) of about  $5\Omega$  and a resonant frequency above 1MHz. Ultra-low-ESR capacitors can cause a low amplitude oscillation on the output and/or underdamped transient response. Most tantalum or aluminum electrolytic capacitors are adequate; film types will work, but are more expensive. Since many aluminum electrolytics have electrolytes that freeze at about  $-30^{\circ}C$ , solid tantalums are recommended for operation below  $-25^{\circ}C$ .

At lower values of output current, less output capacitance is needed for output stability. The capacitor can be reduced to  $0.47\mu F$  for current below 10mA or  $0.33\mu F$  for currents below 1mA.

### No-Load Stability

The MIC5209 will remain stable and in regulation with no load (other than the internal voltage divider) unlike many other voltage regulators. This is especially important in CMOS RAM keep-alive applications.

### Reference Bypass Capacitor

BYP (reference bypass) is available only on devices in SO-8 and TO-263-5 packages.

BYP is connected to the internal voltage reference. A  $470pF$  capacitor ( $C_{BYP}$ ) connected from BYP to GND quiets this reference, providing a significant reduction in output noise (ultra-low-noise performance). Because  $C_{BYP}$  reduces the phase margin, the output capacitor should be increased to at least  $2.2\mu F$  to maintain stability.

The start-up speed of the MIC5209 is inversely proportional to the size of the reference bypass capacitor. Applications requiring a slow ramp-up of output voltage should consider larger values of  $C_{BYP}$ . Likewise, if rapid turn-on is necessary, consider omitting  $C_{BYP}$ .

If output noise is not critical, omit  $C_{BYP}$  and leave BYP open.

## Thermal Considerations

The SOT-223 has a ground tab which allows it to dissipate more power than the SO-8. Refer to "Slot-1 Power Supply" for details. At  $25^{\circ}C$  ambient, it will operate reliably at 2W dissipation with "worst-case" mounting (no ground plane, minimum trace widths, and FR4 printed circuit board).

Thermal resistance values for the SO-8 represent typical mounting on a 1"-square, copper-clad, FR4 circuit board. For greater power dissipation, SO-8 versions of the MIC5209 feature a fused internal lead frame and die bonding arrangement that reduces thermal resistance when compared to standard SO-8 packages.

Package	$\theta_{JA}$	$\theta_{JC}$
SOT-223 (S)	$50^{\circ}C/W$	$8^{\circ}C/W$
SO-8 (M)	$50^{\circ}C/W$	$25^{\circ}C/W$
TO-263-5 (U)	—	$2^{\circ}C/W$

**Table 1. MIC5209 Thermal Resistance**

Multilayer boards with a ground plane, wide traces near the pads, and large supply-bus lines will have better thermal conductivity and will also allow additional power dissipation.

For additional heat sink characteristics, please refer to Micrel Application Hint 17, "Designing P.C. Board Heat Sinks", included in Micrel's *Databook*. For a full discussion of heat sinking and thermal effects on voltage regulators, refer to Regulator Thermals section of Micrel's *Designing with Low-Dropout Voltage Regulators* handbook.

### Low-Voltage Operation

The MIC5209-1.8 and MIC5209-2.5 require special consideration when used in voltage-sensitive systems. They may momentarily overshoot their nominal output voltages unless appropriate output and bypass capacitor values are chosen.

During regulator power up, the pass transistor is fully saturated for a short time, while the error amplifier and voltage reference are being powered up more slowly from the output (see "Block Diagram"). Selecting larger output and bypass capacitors allows additional time for the error amplifier and reference to turn on and prevent overshoot.

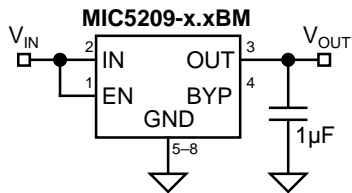
To ensure that no overshoot is present when starting up into a light load ( $100\mu A$ ), use a  $4.7\mu F$  output capacitance and  $470pF$  bypass capacitance. This slows the turn-on enough to allow the regulator to react and keep the output voltage from exceeding its nominal value. At heavier loads, use a  $10\mu F$  output capacitance and  $470pF$  bypass capacitance. Lower values of output and bypass capacitance can be used, depending on the sensitivity of the system.

Applications that can withstand some overshoot on the output of the regulator can reduce the output capacitor and/or reduce or eliminate the bypass capacitor. Applications that are not sensitive to overshoot due to power-on reset delays can use normal output and bypass capacitor configurations.

Please note the junction temperature range of the regulator at 1.8V output (fixed and adjustable) is  $0^{\circ}C$  to  $+125^{\circ}C$ .

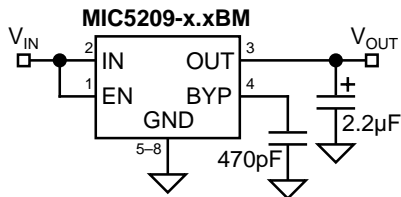


## Fixed Regulator Circuits



**Figure 1. Low-Noise Fixed Voltage Regulator**

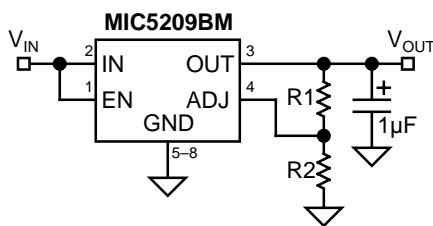
Figure 1 shows a basic MIC5209-x.xBM (SO-8) fixed-voltage regulator circuit. See Figure 5 for a similar configuration using the more thermally-efficient MIC5209-x.xBS (SOT-223). A 1µF minimum output capacitor is required for basic fixed-voltage applications.



**Figure 2. Ultra-Low-Noise Fixed Voltage Regulator**

Figure 2 includes the optional 470pF noise bypass capacitor between BYP and GND to reduce output noise. Note that the minimum value of  $C_{OUT}$  must be increased when the bypass capacitor is used.

## Adjustable Regulator Circuits



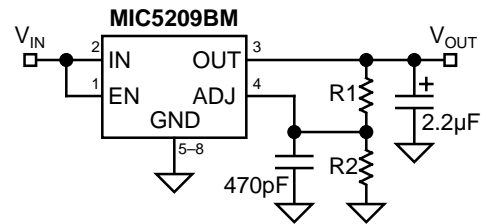
**Figure 3. Low-Noise Adjustable Voltage Regulator**

The MIC5209BM/U can be adjusted to a specific output voltage by using two external resistors (Figure 3). The resistors set the output voltage based on the equation:

$$V_{OUT} = 1.242V \left( 1 + \frac{R2}{R1} \right)$$

This equation is correct due to the configuration of the bandgap reference. The bandgap voltage is relative to the output, as seen in the block diagram. Traditional regulators normally have the reference voltage relative to ground; therefore, their equations are different from the equation for the MIC5209BM/U.

Although ADJ is a high-impedance input, for best performance, R2 should not exceed 470kΩ.



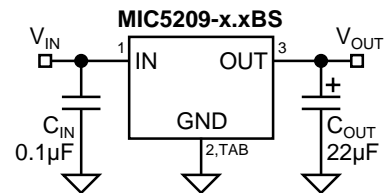
**Figure 4. Ultra-Low-Noise Adjustable Application.**

Figure 4 includes the optional 470pF bypass capacitor from ADJ to GND to reduce output noise.

## Slot-1 Power Supply

Intel's Pentium II processors have a requirement for a 2.5V ±5% power supply for a clock synthesizer and its associated loads. The current requirement for the 2.5V supply is dependant upon the clock synthesizer used, the number of clock outputs, and the type of level shifter (from core logic levels to 2.5V levels). Intel estimates a worst-case load of 320mA.

The MIC5209 was designed to provide the 2.5V power requirement for Slot-1 applications. Its guaranteed performance of 2.5V ±3% at 500mA allows adequate margin for all systems, and its dropout voltage of 500mV means that it operates from a worst-case 3.3V supply where the voltage can be as low as 3.0V.



**Figure 5. Slot-1 Power Supply**

A Slot-1 power supply (Figure 5) is easy to implement. Only two capacitors are necessary, and their values are not critical.  $C_{IN}$  bypasses the internal circuitry and should be at least 0.1µF.  $C_{OUT}$  provides output filtering, improves transient response, and compensates the internal regulator control loop. Its value should be at least 22µF.  $C_{IN}$  and  $C_{OUT}$  may be increased as much as desired.

## Slot-1 Power Supply Power Dissipation

Powered from a 3.3V supply, the Slot-1 power supply of Figure 5 has a nominal efficiency of 75%. At the maximum anticipated Slot 1 load (320mA), the nominal power dissipation is only 256mW.

The SOT-223 package has sufficient thermal characteristics for wide design margins when mounted on a single layer copper-clad printed circuit board. The power dissipation of

the MIC5209 is calculated using the voltage drop across the device  $\times$  output current plus supply voltage  $\times$  ground current. Considering worst case tolerances, the power dissipation could be as high as:

$$P_D = (V_{IN(max)} - V_{OUT(max)}) \times I_{OUT} + V_{IN(max)} \times I_{GND}$$

$$[(3.6V - 2.375V) \times 320mA] + (3.6V \times 4mA)$$

$$P_D = 407mW$$

Using the maximum junction temperature of 125°C and a  $\theta_{JC}$  of 8°C/W for the SOT-223, 25°C/W for the SO-8, or 2°C/W for the TO-263 package, the following worst-case heat-sink thermal resistance ( $\theta_{SA}$ ) requirements are:

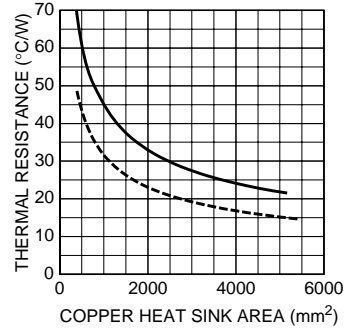
$$\theta_{JA} = \frac{T_{J(max)} - T_A}{P_D}$$

$$\theta_{SA} = \theta_{JA} - \theta_{JC}$$

T <sub>A</sub>	40°C	50°C	60°C	75°C
$\theta_{JA}$ (limit)	209°C/W	184°C/W	160°C/W	123°C/W
$\theta_{SA}$ SOT-223	201°C/W	176°C/W	152°C/W	115°C/W
$\theta_{SA}$ SO-8	184°C/W	159°C/W	135°C/W	98°C/W
$\theta_{SA}$ TO-263-5	207°C/W	182°C/W	158°C/W	121°C/W

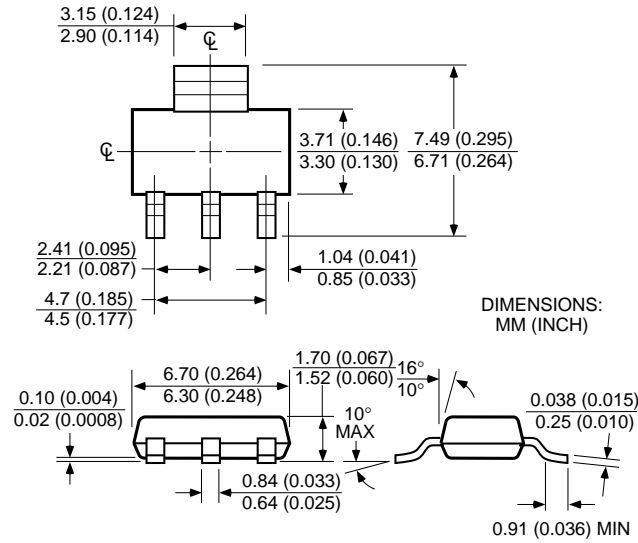
**Table 2. Maximum Allowable Thermal Resistance**

Table 2 and Figure 6 show that the Slot-1 power supply application can be implemented with a minimum footprint layout. Figure 6 shows the necessary copper pad area to obtain specific heat sink thermal resistance ( $\theta_{SA}$ ) values. The  $\theta_{SA}$  values in Table 2 require much less than 500mm<sup>2</sup> of copper, according to Figure 6, and can easily be accomplished with the minimum footprint.

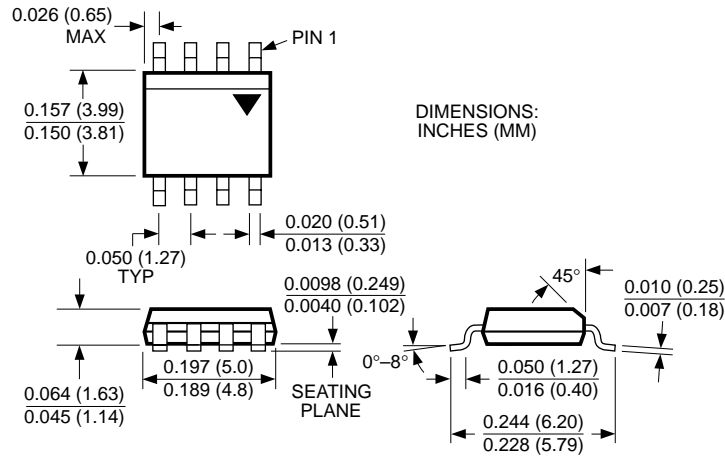


**Figure 6. PCB Heat Sink Thermal Resistance**

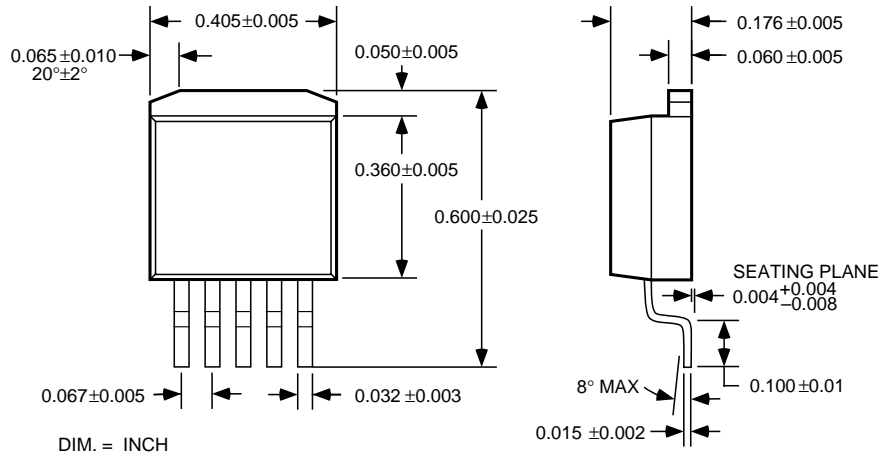
Package Information



SOT-223 (S)



8-Pin SOP (M)



DIM. = INCH

TO-263-5 (U)

---

**MICREL INC. 1849 FORTUNE DRIVE SAN JOSE, CA 95131 USA**

TEL + 1 (408) 944-0800 FAX + 1 (408) 944-0970 WEB <http://www.micrel.com>

This information is believed to be accurate and reliable, however no responsibility is assumed by Micrel for its use nor for any infringement of patents or other rights of third parties resulting from its use. No license is granted by implication or otherwise under any patent or patent right of Micrel Inc.

© 2000 Micrel Incorporated