

## 50mA and 100mA CMOS LDOs with Shutdown, $\overline{\text{ERROR}}$ Output and $V_{\text{REF}}$ Bypass

### Features

- Zero Ground Current for Longer Battery Life
- Very Low Dropout Voltage
- Choice of 50mA (TC1072) and 100mA (TC1073) Output
- High Output Voltage Accuracy
- Standard or Custom Output Voltages
- Power-Saving Shutdown Mode
- $\overline{\text{ERROR}}$  Output Can Be Used as a Low Battery Detector or Processor Reset Generator
- Bypass Input for Ultra Quiet Operation
- Over Current and Over Temperature Protection
- Space-Saving 6-Pin SOT-23A Package
- Pin Compatible Upgrades for Bipolar Regulators

### Applications

- Battery Operated Systems
- Portable Computers
- Medical Instruments
- Instrumentation
- Cellular/GSM/PHS Phones
- Linear Post-Regulators for SMPS
- Pagers

### Device Selection Table

Part Number	Package	Junction Temp. Range
TC1072-xxVCH	6-Pin SOT-23A	-40°C to +125°C
TC1073-xxVCH	6-Pin SOT-23A	-40°C to +125°C

**NOTE:** xx indicates output voltages

Available Output Voltages: 2.5, 2.7, 2.8, 2.85, 3.0, 3.3, 3.6, 4.0, 5.0.

Other output voltages are available. Please contact Microchip Technology Inc. for details.

### Package Type

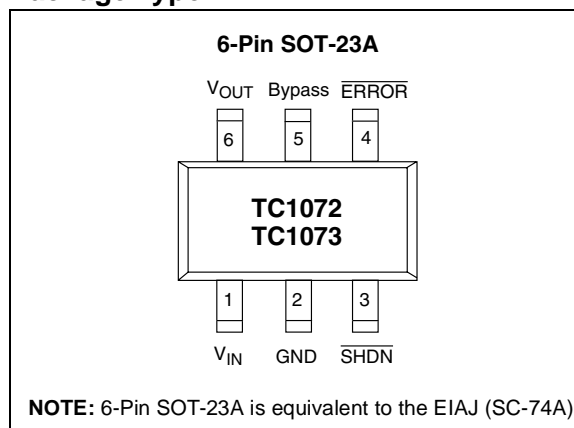

# TC1072/TC1073

## General Description

The TC1072 and TC1073 are high accuracy (typically  $\pm 0.5\%$ ) CMOS upgrades for older (bipolar) low dropout regulators. Designed specifically for battery-operated systems, the devices' CMOS construction eliminates wasted ground current, significantly extending battery life. Total supply current is typically  $50\mu\text{A}$  at full load (20 to 60 times lower than in bipolar regulators).

The devices' key features include ultra low noise operation (plus optional Bypass input); very low dropout voltage (typically  $85\text{mV}$ , TC1072 and  $180\text{mV}$ , TC1073 at full load) and fast response to step changes in load. An error output (ERROR) is asserted when the devices are out-of-regulation (due to a low input voltage or excessive output current). ERROR can be used as a low battery warning or as a processor RESET signal (with the addition of an external RC network). Supply current is reduced to  $0.5\mu\text{A}$  (max) and both  $V_{\text{OUT}}$  and ERROR are disabled when the shutdown input is low. The devices incorporate both over-temperature and over-current protection.

The TC1072 and TC1073 are stable with an output capacitor of only  $1\mu\text{F}$  and have a maximum output current of  $50\text{mA}$ , and  $100\text{mA}$  respectively. For higher output current versions, please see the TC1185, TC1186, TC1187 ( $I_{\text{OUT}} = 150\text{mA}$ ) and TC1107, TC1108 and TC1173 ( $I_{\text{OUT}} = 300\text{mA}$ ) data sheets.

## Typical Application

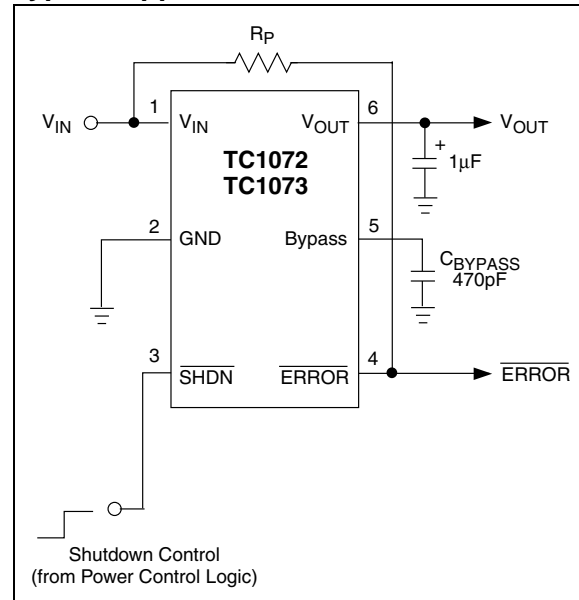

## 1.0 ELECTRICAL CHARACTERISTICS

### Absolute Maximum Ratings\*

Input Voltage.....	6.5V
Output Voltage.....	(-0.3V) to (V <sub>IN</sub> + 0.3V)
Power Dissipation.....	Internally Limited ( <b>Note 6</b> )
Maximum Voltage on Any Pin .....	V <sub>IN</sub> +0.3V to -0.3V
Operating Temperature Range .....	-40°C < T <sub>J</sub> < 125°C
Storage Temperature.....	-65°C to +150°C

\*Stresses above those listed under "Absolute Maximum Ratings" may cause permanent damage to the device. These are stress ratings only and functional operation of the device at these or any other conditions above those indicated in the operation sections of the specifications is not implied. Exposure to Absolute Maximum Rating conditions for extended periods may affect device reliability.

### TC1072/TC1073 ELECTRICAL SPECIFICATIONS

Electrical Characteristics: V <sub>IN</sub> = V <sub>OUT</sub> + 1V, I <sub>L</sub> = 0.1mA, C <sub>L</sub> = 3.3μF, $\overline{\text{SHDN}} > V_{IH}$ , T <sub>A</sub> = 25°C, unless otherwise noted. <b>Boldface</b> type specifications apply for junction temperatures of -40°C to +125°C.						
Symbol	Parameter	Min	Typ	Max	Units	Test Conditions
V <sub>IN</sub>	Input Operating Voltage	<b>2.7</b>	—	<b>6.0</b>	V	<b>Note 9</b>
I <sub>OUTMAX</sub>	Maximum Output Current	<b>50</b> <b>100</b>	—	—	mA mA	TC1072 TC1073
V <sub>OUT</sub>	Output Voltage	<b>V<sub>R</sub> - 2.5%</b>	V <sub>R</sub> ±0.5%	<b>V<sub>R</sub> + 2.5%</b>	V	<b>Note 1</b>
TCV <sub>OUT</sub>	V <sub>OUT</sub> Temperature Coefficient	—	20 <b>40</b>	—	ppm/°C	<b>Note 2</b>
ΔV <sub>OUT</sub> /ΔV <sub>IN</sub>	Line Regulation	—	0.05	<b>0.35</b>	%	(V <sub>R</sub> + 1V) ≤ V <sub>IN</sub> ≤ 6V
ΔV <sub>OUT</sub> /V <sub>OUT</sub>	Load Regulation	—	0.5	<b>2.0</b>	%	I <sub>L</sub> = 0.1mA to I <sub>OUTMAX</sub> <b>(Note 3)</b>
V <sub>IN</sub> -V <sub>OUT</sub>	Dropout Voltage	—	2 65 85 180	—	mV	I <sub>L</sub> = 0.1mA I <sub>L</sub> = 20mA I <sub>L</sub> = 50mA I <sub>L</sub> = 100mA ( <b>Note 4</b> ), TC1073
I <sub>IN</sub>	Supply Current	—	50	<b>80</b>	μA	$\overline{\text{SHDN}} = V_{IH}$ , I <sub>L</sub> = 0 ( <b>Note 8</b> )
I <sub>INSD</sub>	Shutdown Supply Current	—	0.05	<b>0.5</b>	μA	$\overline{\text{SHDN}} = 0V$
PSRR	Power Supply Rejection Ratio	—	64	—	dB	F <sub>RE</sub> ≤ 1kHz
I <sub>OUTsc</sub>	Output Short Circuit Current	—	300	450	mA	V <sub>OUT</sub> = 0V
ΔV <sub>OUT</sub> /ΔP <sub>D</sub>	Thermal Regulation	—	0.04	—	V/W	<b>Notes 5, 6</b>
T <sub>SD</sub>	Thermal Shutdown Die Temperature	—	160	—	°C	
ΔT <sub>SD</sub>	Thermal Shutdown Hysteresis	—	10	—	°C	
eN	Output Noise	—	260	—	nV/√Hz	I <sub>L</sub> = I <sub>OUTMAX</sub> 470pF from Bypass to GND
<b>SHDN Input</b>						
V <sub>IH</sub>	SHDN Input High Threshold	45	—	—	%V <sub>IN</sub>	V <sub>IN</sub> = 2.5V to 6.5V
V <sub>IL</sub>	SHDN Input Low Threshold	—	—	15	%V <sub>IN</sub>	V <sub>IN</sub> = 2.5V to 6.5V

**Note 1:** V<sub>R</sub> is the regulator output voltage setting. For example: V<sub>R</sub> = 2.5V, 2.7V, 2.85V, 3.0V, 3.3V, 3.6V, 4.0V, 5.0V.

**Note 2:**  $TC V_{OUT} = \frac{(V_{OUTMAX} - V_{OUTMIN}) \times 10^6}{V_{OUT} \times \Delta T}$

**Note 3:** Regulation is measured at a constant junction temperature using low duty cycle pulse testing. Load regulation is tested over a load range from 0.1mA to the maximum specified output current. Changes in output voltage due to heating effects are covered by the thermal regulation specification.

**Note 4:** Dropout voltage is defined as the input to output differential at which the output voltage drops 2% below its nominal value.

**Note 5:** Thermal Regulation is defined as the change in output voltage at a time T after a change in power dissipation is applied, excluding load or line regulation effects. Specifications are for a current pulse equal to I<sub>LMAX</sub> at V<sub>IN</sub> = 6V for T = 10 msec.

**Note 6:** The maximum allowable power dissipation is a function of ambient temperature, the maximum allowable junction temperature and the thermal resistance from junction-to-air (i.e., T<sub>A</sub>, T<sub>J</sub>, θ<sub>JA</sub>). Exceeding the maximum allowable power dissipation causes the device to initiate thermal shutdown. Please see Section 4.0 Thermal Considerations for more details.

**Note 7:** Hysteresis voltage is referenced by V<sub>R</sub>.

**Note 8:** Apply for Junction Temperatures of -40°C to +85°C.

**Note 9:** The minimum V<sub>IN</sub> has to justify the conditions = V<sub>IN</sub> ≥ V<sub>R</sub> + V<sub>DROPOUT</sub> and V<sub>IN</sub> ≥ 2.7V for I<sub>L</sub> = 0.1mA to I<sub>OUTMAX</sub>.

# TC1072/TC1073

## TC1072/TC1073 ELECTRICAL SPECIFICATIONS (CONTINUED)

**Electrical Characteristics:**  $V_{IN} = V_{OUT} + 1V$ ,  $I_L = 0.1mA$ ,  $C_L = 3.3\mu F$ ,  $\overline{SHDN} > V_{IH}$ ,  $T_A = 25^\circ C$ , unless otherwise noted. **Boldface** type specifications apply for junction temperatures of  $-40^\circ C$  to  $+125^\circ C$ .

Symbol	Parameter	Min	Typ	Max	Units	Test Conditions
<b>ERROR Open Drain Output</b>						
$V_{INMIN}$	Minimum $V_{IN}$ Operating Voltage	1.0	—	—	V	
$V_{OL}$	Output Logic Low Voltage	—	—	400	mV	1 mA Flows to $\overline{ERROR}$
$V_{TH}$	$\overline{ERROR}$ Threshold Voltage	—	$0.95 \times V_R$	—	V	See Figure 3-2
$V_{HYS}$	$\overline{ERROR}$ Positive Hysteresis	—	50	—	mV	<b>Note 7</b>

**Note 1:**  $V_R$  is the regulator output voltage setting. For example:  $V_R = 2.5V, 2.7V, 2.85V, 3.0V, 3.3V, 3.6V, 4.0V, 5.0V$ .

**Note 2:**  $TC V_{OUT} = \frac{(V_{OUTMAX} - V_{OUTMIN}) \times 10^6}{V_{OUT} \times \Delta T}$

- Note 3:** Regulation is measured at a constant junction temperature using low duty cycle pulse testing. Load regulation is tested over a load range from 0.1mA to the maximum specified output current. Changes in output voltage due to heating effects are covered by the thermal regulation specification.
- Note 4:** Dropout voltage is defined as the input to output differential at which the output voltage drops 2% below its nominal value.
- Note 5:** Thermal Regulation is defined as the change in output voltage at a time T after a change in power dissipation is applied, excluding load or line regulation effects. Specifications are for a current pulse equal to  $I_{LMAX}$  at  $V_{IN} = 6V$  for  $T = 10$  msec.
- Note 6:** The maximum allowable power dissipation is a function of ambient temperature, the maximum allowable junction temperature and the thermal resistance from junction-to-air (i.e.,  $T_A, T_J, \theta_{JA}$ ). Exceeding the maximum allowable power dissipation causes the device to initiate thermal shutdown. Please see Section 4.0 Thermal Considerations for more details.
- Note 7:** Hysteresis voltage is referenced by  $V_R$ .
- Note 8:** Apply for Junction Temperatures of  $-40^\circ C$  to  $+85^\circ C$ .
- Note 9:** The minimum  $V_{IN}$  has to justify the conditions =  $V_{IN} \geq V_R + V_{DROPOUT}$  and  $V_{IN} \geq 2.7V$  for  $I_L = 0.1mA$  to  $I_{OUTMAX}$ .

## 2.0 PIN DESCRIPTIONS

The descriptions of the pins are listed in Table 2-1.

**TABLE 2-1: PIN FUNCTION TABLE**

Pin No. (6-Pin SOT-23A)	Symbol	Description
1	$V_{IN}$	Unregulated supply input.
2	GND	Ground terminal.
3	$\overline{\text{SHDN}}$	Shutdown control input. The regulator is fully enabled when a logic high is applied to this input. The regulator enters shutdown when a logic low is applied to this input. During shutdown, output voltage falls to zero and supply current is reduced to 0.05 $\mu$ A (typical).
4	$\overline{\text{ERROR}}$	Out-of-Regulation Flag. (Open drain output). This output goes low when $V_{OUT}$ is out-of-tolerance by approximately $\pm 5\%$ .
5	Bypass	Reference bypass input. Connecting a 470pF to this input further reduces output noise.
6	$V_{OUT}$	Regulated voltage output.

# TC1072/TC1073

## 3.0 DETAILED DESCRIPTION

The TC1072 and TC1073 are precision fixed output voltage regulators. (If an adjustable version is desired, please see the TC1070/TC1071/TC1187 data sheet.) Unlike bipolar regulators, the TC1072 and TC1073's supply current does not increase with load current. In addition,  $V_{OUT}$  remains stable and within regulation over the entire 0mA to  $I_{OUTMAX}$  load current range, (an important consideration in RTC and CMOS RAM battery back-up applications).

Figure 3-1 shows a typical application circuit. The regulator is enabled any time the shutdown input (SHDN) is at or above  $V_{IH}$ , and shutdown (disabled) when SHDN is at or below  $V_{IL}$ . SHDN may be controlled by a CMOS logic gate, or I/O port of a microcontroller. If the SHDN input is not required, it should be connected directly to the input supply. While in shutdown, supply current decreases to 0.05 $\mu$ A (typical),  $V_{OUT}$  falls to zero volts, and ERROR is open-circuited.

FIGURE 3-1: TYPICAL APPLICATION CIRCUIT

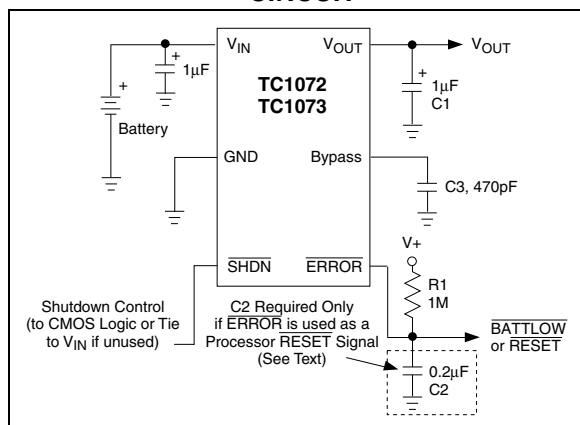

### 3.1 ERROR Open Drain Output

ERROR is driven low whenever  $V_{OUT}$  falls out of regulation by more than -5% (typical). This condition may be caused by low input voltage, output current limiting, or thermal limiting. The ERROR output voltage value (e.g. ERROR =  $V_{OL}$  at 4.75V (typ.) for a 5.0V regulator and 2.85V (typ.) for a 3.0V regulator).  $\overline{\text{ERROR}}$  output operation is shown in Figure 3-2.

Note that ERROR is active when  $V_{OUT}$  falls to  $V_{TH}$ , and inactive when  $V_{OUT}$  rises above  $V_{TH}$  by  $V_{HYS}$ .

As shown in Figure 3-1,  $\overline{\text{ERROR}}$  can be used as a battery low flag, or as a processor RESET signal (with the addition of timing capacitor C2).  $R1 \times C2$  should be chosen to maintain ERROR below  $V_{IH}$  of the processor RESET input for at least 200 msec to allow time for the system to stabilize. Pull-up resistor R1 can be tied to  $V_{OUT}$ ,  $V_{IN}$  or any other voltage less than  $(V_{IN} + 0.3V)$ .

FIGURE 3-2:  $\overline{\text{ERROR}}$  OUTPUT OPERATION

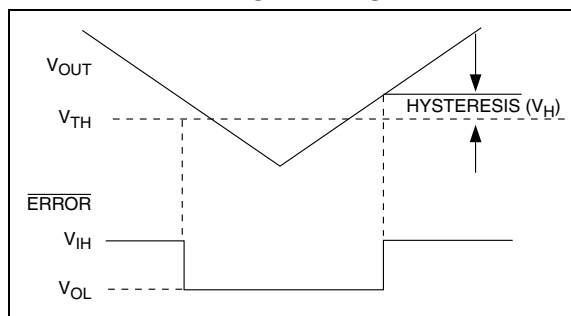

### 3.2 Output Capacitor

A 1 $\mu$ F (min) capacitor from  $V_{OUT}$  to ground is recommended. The output capacitor should have an effective series resistance greater than 0.1 $\Omega$  and less than 5.0 $\Omega$ , and a resonant frequency above 1MHz. A 1 $\mu$ F capacitor should be connected from  $V_{IN}$  to GND if there is more than 10 inches of wire between the regulator and the AC filter capacitor, or if a battery is used as the power source. Aluminum electrolytic or tantalum capacitor types can be used. (Since many aluminum electrolytic capacitors freeze at approximately -30 $^{\circ}$ C, solid tantalums are recommended for applications operating below -25 $^{\circ}$ C.) When operating from sources other than batteries, supply-noise rejection and transient response can be improved by increasing the value of the input and output capacitors and employing passive filtering techniques.

### 3.3 Bypass Input

A 470pF capacitor connected from the Bypass input to ground reduces noise present on the internal reference, which in turn significantly reduces output noise. If output noise is not a concern, this input may be left unconnected. Larger capacitor values may be used, but results in a longer time period to rated output voltage when power is initially applied.

## 4.0 THERMAL CONSIDERATIONS

### 4.1 Thermal Shutdown

Integrated thermal protection circuitry shuts the regulator off when die temperature exceeds 160°C. The regulator remains off until the die temperature drops to approximately 150°C.

### 4.2 Power Dissipation

The amount of power the regulator dissipates is primarily a function of input and output voltage, and output current. The following equation is used to calculate worst case *actual* power dissipation:

#### EQUATION 4-1:

$$P_D \approx (V_{INMAX} - V_{OUTMIN})I_{LOADMAX}$$

Where:

$P_D$  = Worst case actual power dissipation  
 $V_{INMAX}$  = Maximum voltage on  $V_{IN}$   
 $V_{OUTMIN}$  = Minimum regulator output voltage  
 $I_{LOADMAX}$  = Maximum output (load) current

The maximum *allowable* power dissipation (Equation 4-2) is a function of the maximum ambient temperature ( $T_{AMAX}$ ), the maximum allowable die temperature ( $T_{JMAX}$ ) and the thermal resistance from junction-to-air ( $\theta_{JA}$ ). The 6-Pin SOT-23A package has a  $\theta_{JA}$  of approximately 220°C/Watt.

#### EQUATION 4-2:

$$P_{DMAX} = \frac{(T_{JMAX} - T_{AMAX})}{\theta_{JA}}$$

Where all terms are previously defined.

Equation 4-1 can be used in conjunction with Equation 4-2 to ensure regulator thermal operation is within limits. For example:

Given:

$$V_{INMAX} = 3.0V \pm 5\%$$

$$V_{OUTMIN} = 2.7V - 2.5\%$$

$$I_{LOADMAX} = 40mA$$

$$T_{JMAX} = 125^\circ C$$

$$T_{AMAX} = 55^\circ C$$

Find: 1. Actual power dissipation  
 2. Maximum allowable dissipation

Actual power dissipation:

$$\begin{aligned} P_D &\approx (V_{INMAX} - V_{OUTMIN})I_{LOADMAX} \\ &= [(3.0 \times 1.05) - (2.7 \times .975)]40 \times 10^{-3} \\ &= 20.7mW \end{aligned}$$

Maximum allowable power dissipation:

$$\begin{aligned} P_{DMAX} &= \frac{(T_{JMAX} - T_{AMAX})}{\theta_{JA}} \\ &= \frac{(125 - 55)}{220} \\ &= 318mW \end{aligned}$$

In this example, the TC1072 dissipates a maximum of 20.7mW; below the allowable limit of 318mW. In a similar manner, Equation 4-1 and Equation 4-2 can be used to calculate maximum current and/or input voltage limits.

### 4.3 Layout Considerations

The primary path of heat conduction out of the package is via the package leads. Therefore, layouts having a ground plane, wide traces at the pads, and wide power supply bus lines combine to lower  $\theta_{JA}$  and therefore increase the maximum allowable power dissipation limit.

# TC1072/TC1073

## 5.0 TYPICAL CHARACTERISTICS

(Unless Otherwise Specified, All Parts Are Measured At Temperature = 25°C)

**Note:** The graphs and tables provided following this note are a statistical summary based on a limited number of samples and are provided for informational purposes only. The performance characteristics listed herein are not tested or guaranteed. In some graphs or tables, the data presented may be outside the specified operating range (e.g., outside specified power supply range) and therefore outside the warranted range.

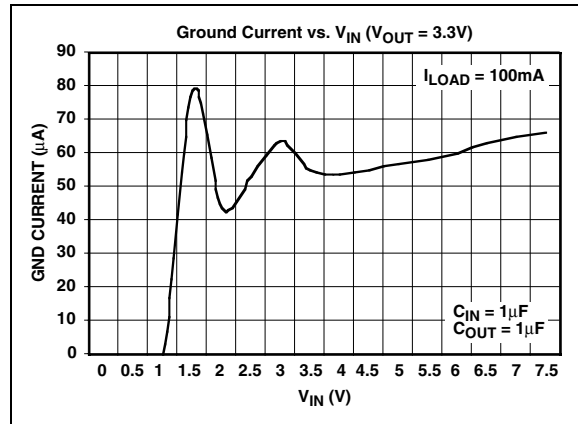
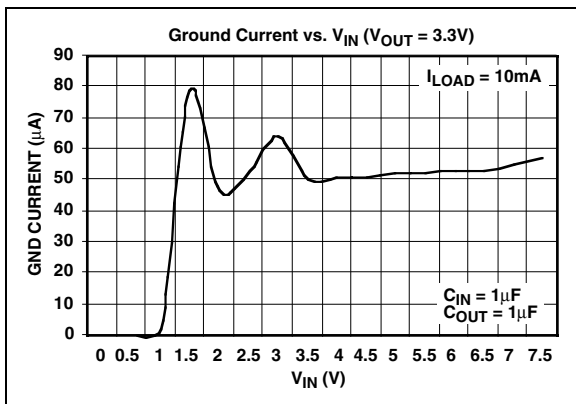
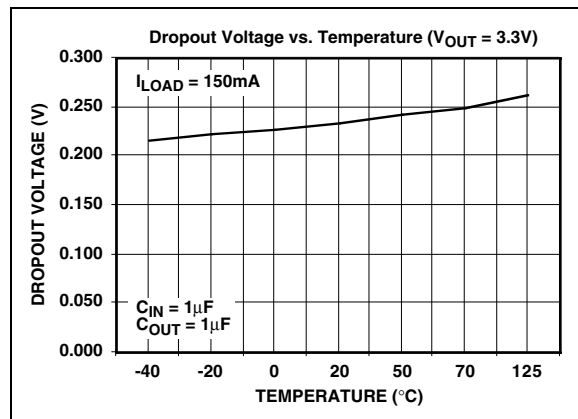
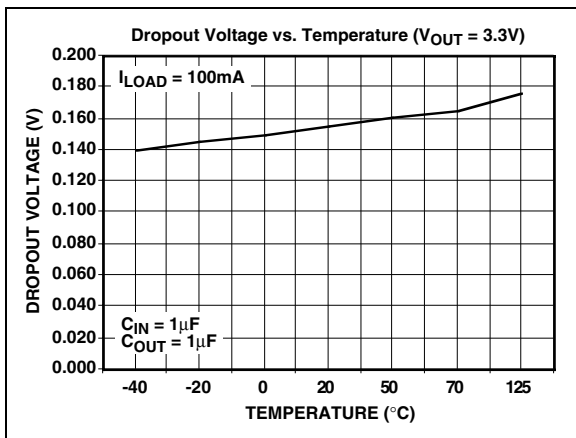
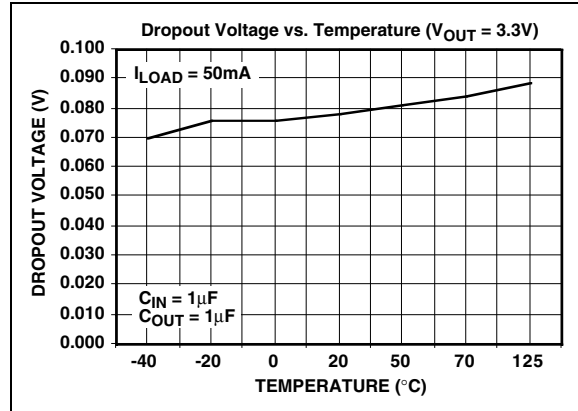
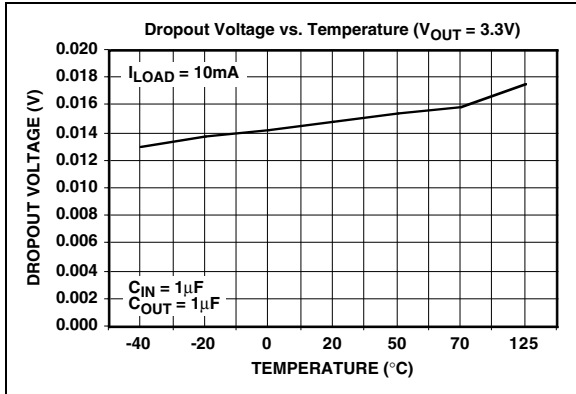



## 5.0 TYPICAL CHARACTERISTICS (CONTINUED)

(Unless Otherwise Specified, All Parts Are Measured At Temperature = 25°C)

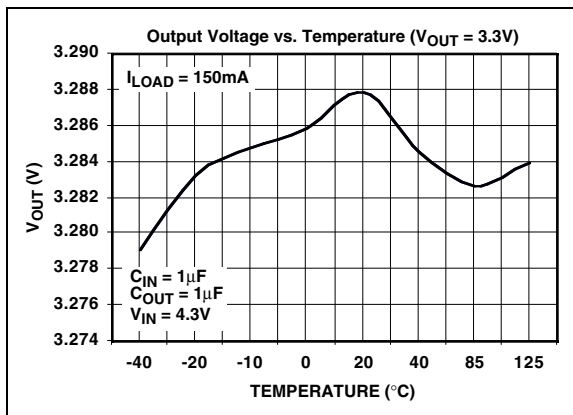
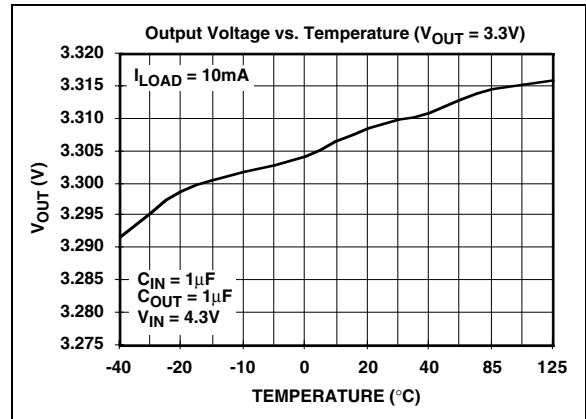
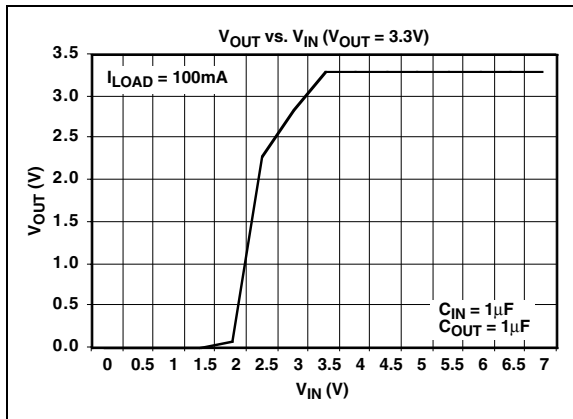
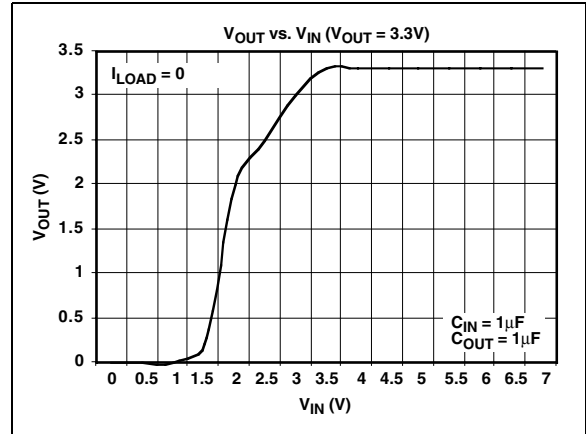
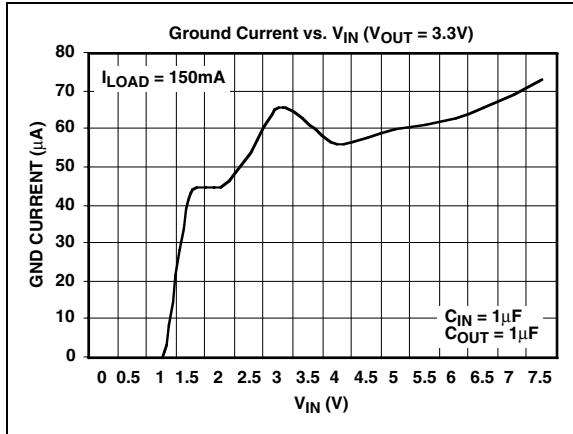

# TC1072/TC1073

## 5.0 TYPICAL CHARACTERISTICS (CONTINUED)

(Unless Otherwise Specified, All Parts Are Measured At Temperature = 25°C)

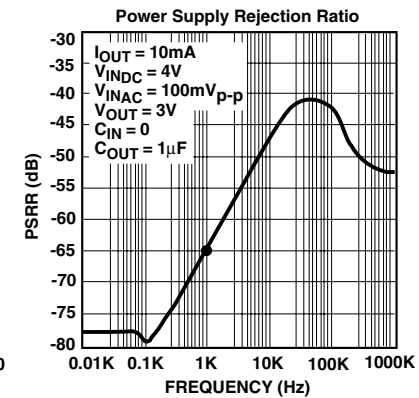
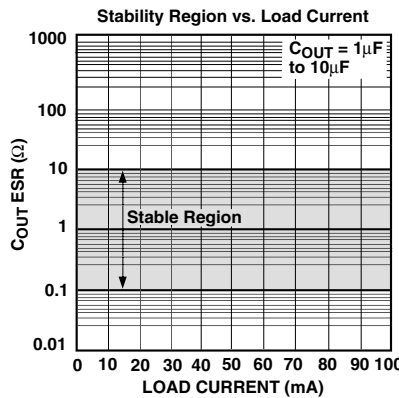
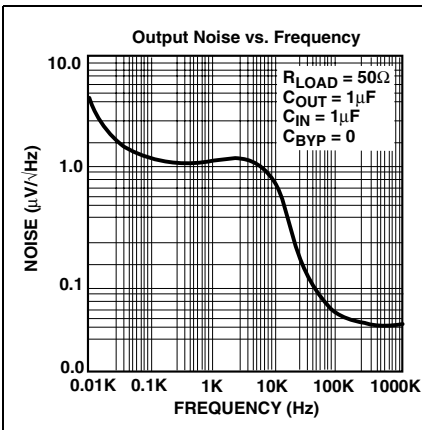
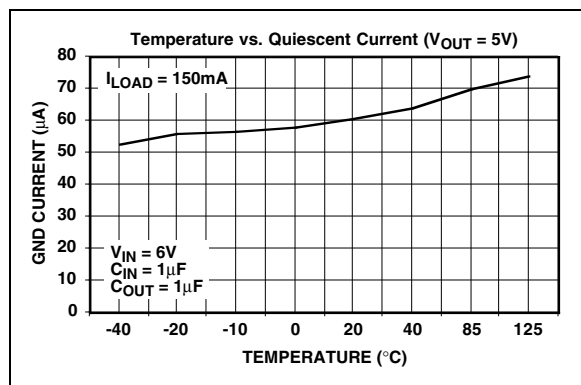
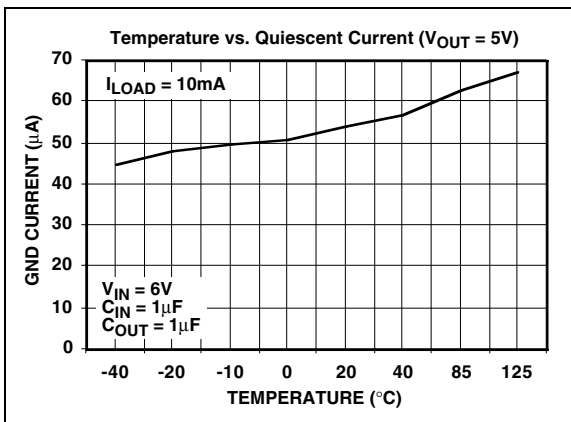
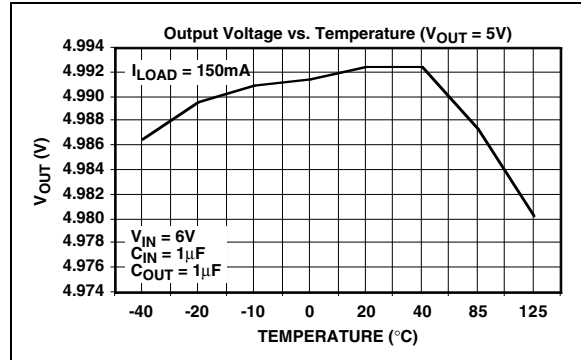
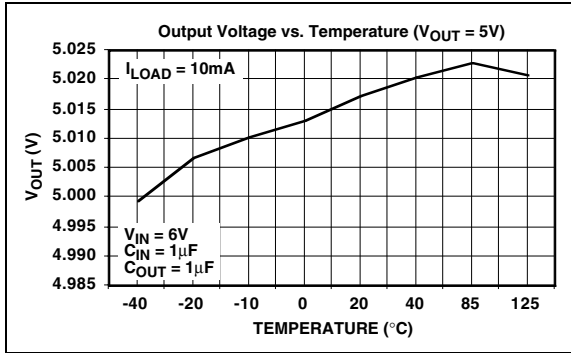

## 5.0 TYPICAL CHARACTERISTICS (CONTINUED)

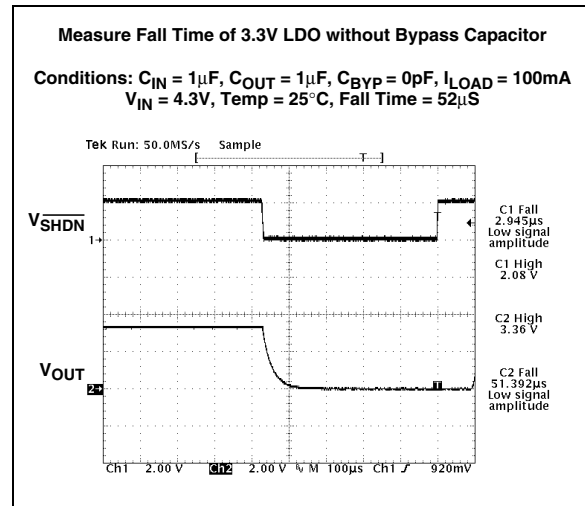
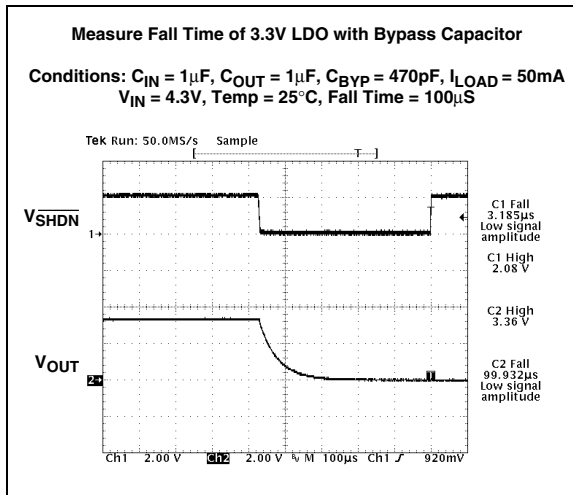
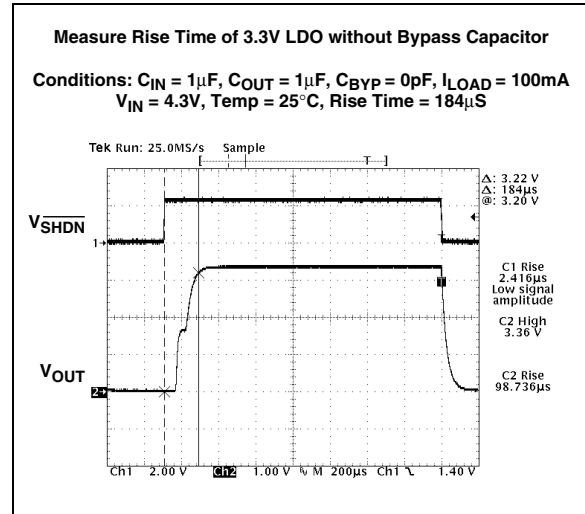
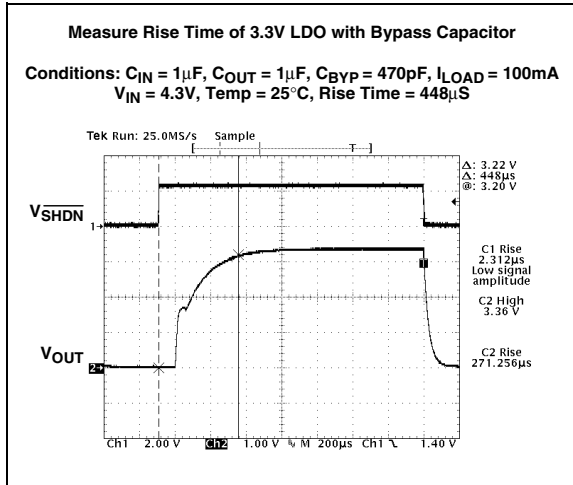

# TC1072/TC1073

## 5.0 TYPICAL CHARACTERISTICS (CONTINUED)

Measure Rise Time of 5.0V LDO with Bypass Capacitor

Conditions:  $C_{IN} = 1\mu\text{F}$ ,  $C_{OUT} = 1\mu\text{F}$ ,  $C_{BYP} = 470\text{pF}$ ,  $I_{LOAD} = 100\text{mA}$   
 $V_{IN} = 6\text{V}$ , Temp = 25°C, Rise Time = 390 $\mu\text{s}$

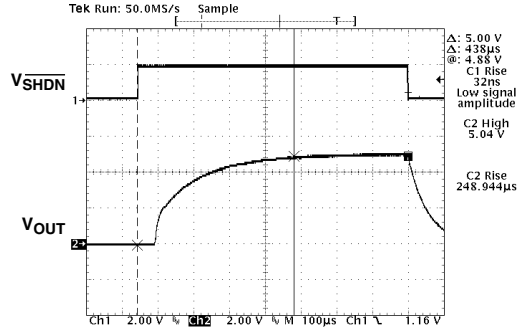

Measure Rise Time of 5.0V LDO without Bypass Capacitor

Conditions:  $C_{IN} = 1\mu\text{F}$ ,  $C_{OUT} = 1\mu\text{F}$ ,  $C_{BYP} = 0\text{pF}$ ,  $I_{LOAD} = 100\text{mA}$   
 $V_{IN} = 6\text{V}$ , Temp = 25°C, Rise Time = 192 $\mu\text{s}$

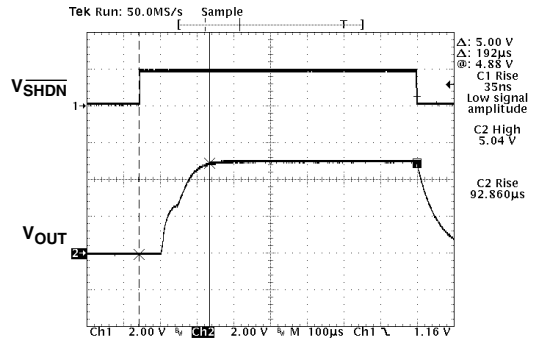

Measure Fall Time of 5.0V LDO with Bypass Capacitor

Conditions:  $C_{IN} = 1\mu\text{F}$ ,  $C_{OUT} = 1\mu\text{F}$ ,  $C_{BYP} = 470\text{pF}$ ,  $I_{LOAD} = 50\text{mA}$   
 $V_{IN} = 6\text{V}$ , Temp = 25°C, Fall Time = 167 $\mu\text{s}$

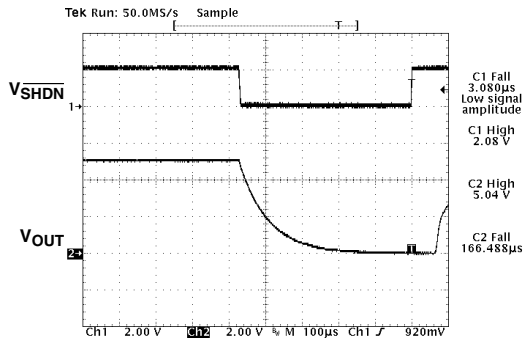

Measure Fall Time of 5.0V LDO without Bypass Capacitor

Conditions:  $C_{IN} = 1\mu\text{F}$ ,  $C_{OUT} = 1\mu\text{F}$ ,  $C_{BYP} = 0\text{pF}$ ,  $I_{LOAD} = 100\text{mA}$   
 $V_{IN} = 6\text{V}$ , Temp = 25°C, Fall Time = 88 $\mu\text{s}$

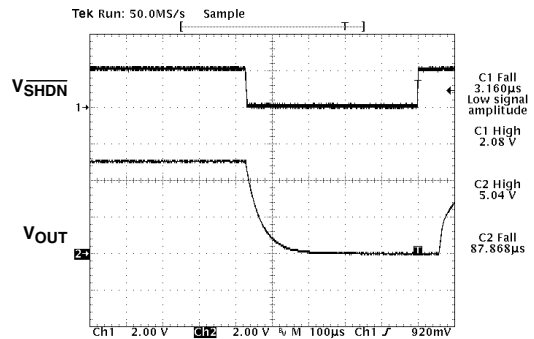

## 5.0 TYPICAL CHARACTERISTICS (CONTINUED)

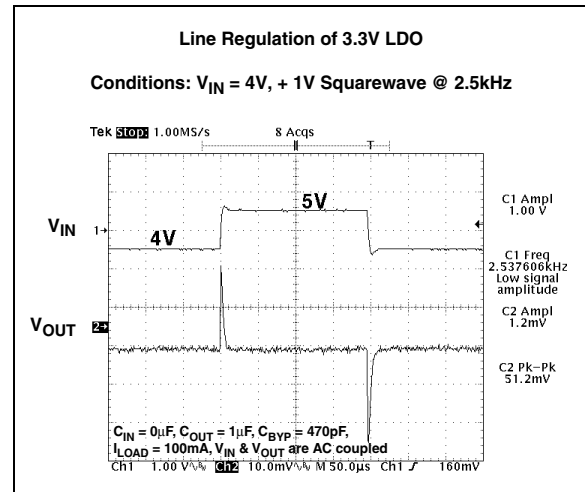
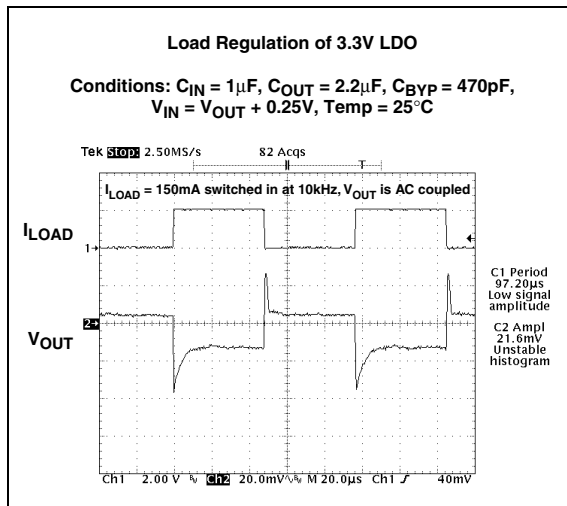
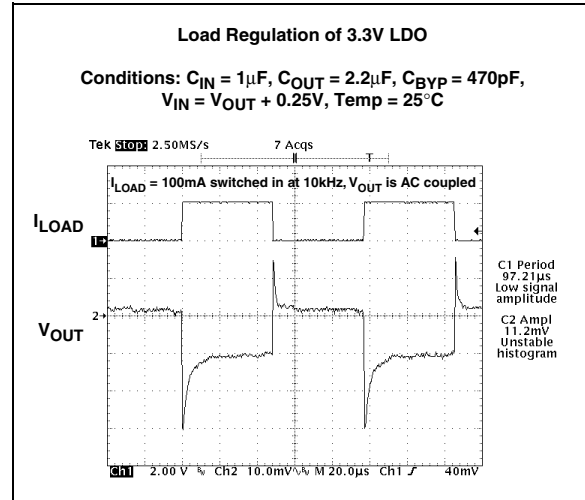
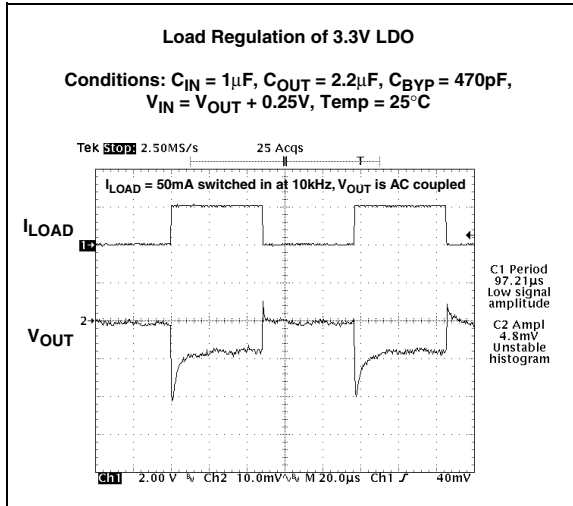

# TC1072/TC1073

## 5.0 TYPICAL CHARACTERISTICS (CONTINUED)

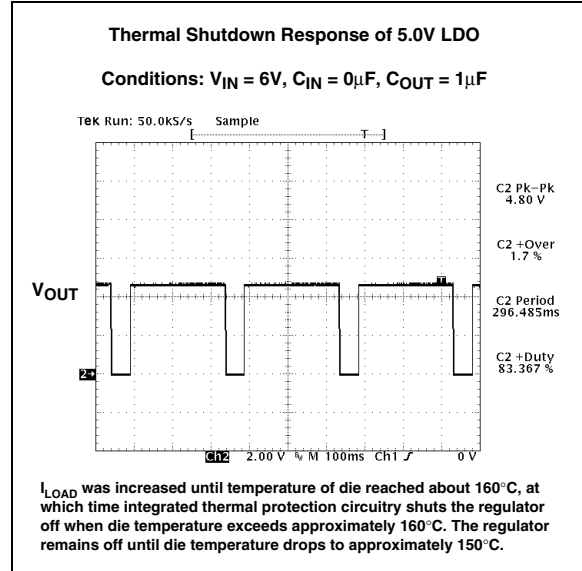
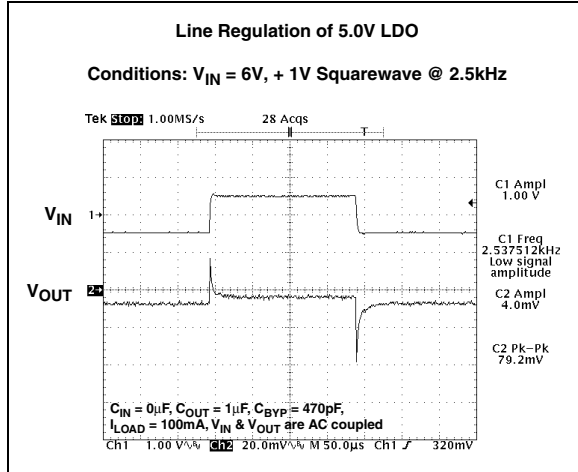

## 6.0 PACKAGING INFORMATION

### 6.1 Package Marking Information

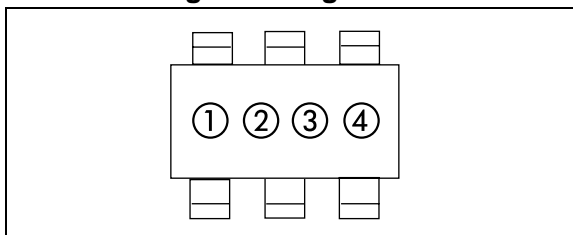

“1” & “2” = part number code + temperature range and voltage

(V)	TC1072 Code	TC1073 Code
2.5	E1	F1
2.7	E2	F2
2.8	EZ	FZ
2.85	E8	F8
3.0	E3	F3
3.3	E5	F5
3.6	E9	F9
4.0	E0	F0
5.0	E7	F7

“3” represents year and quarter code

“4” represents lot ID number

### 6.2 Taping Form

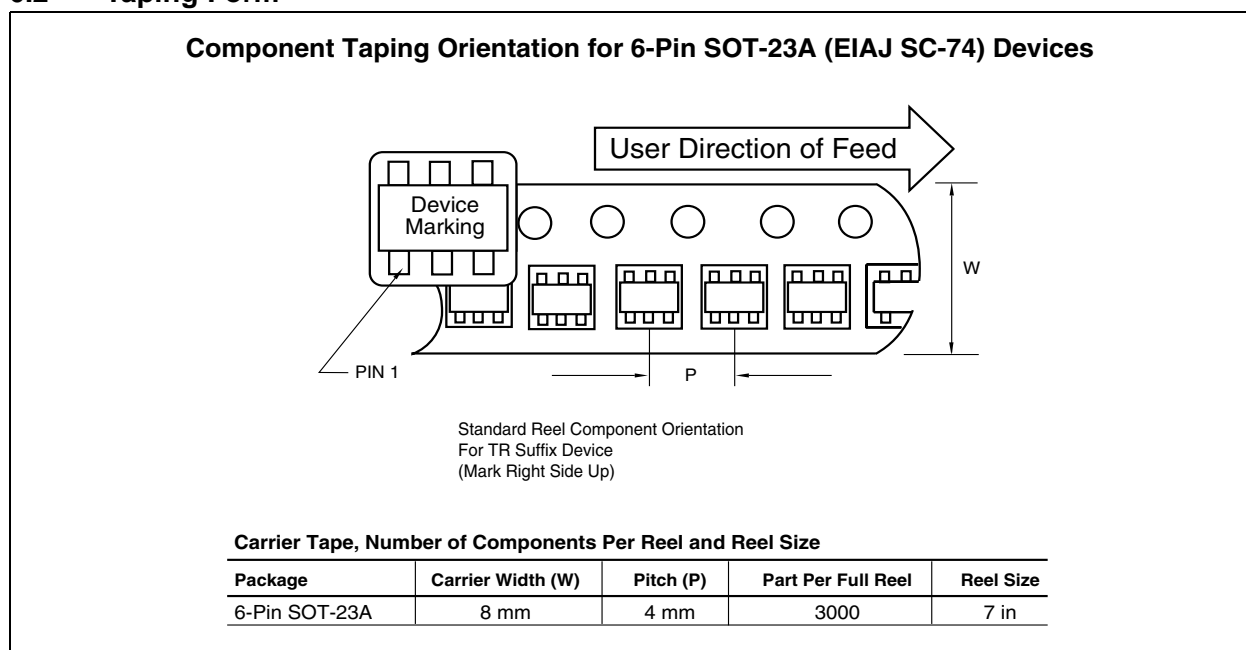

# TC1072/TC1073

## 6.3 Package Dimensions

### SOT-23A-6

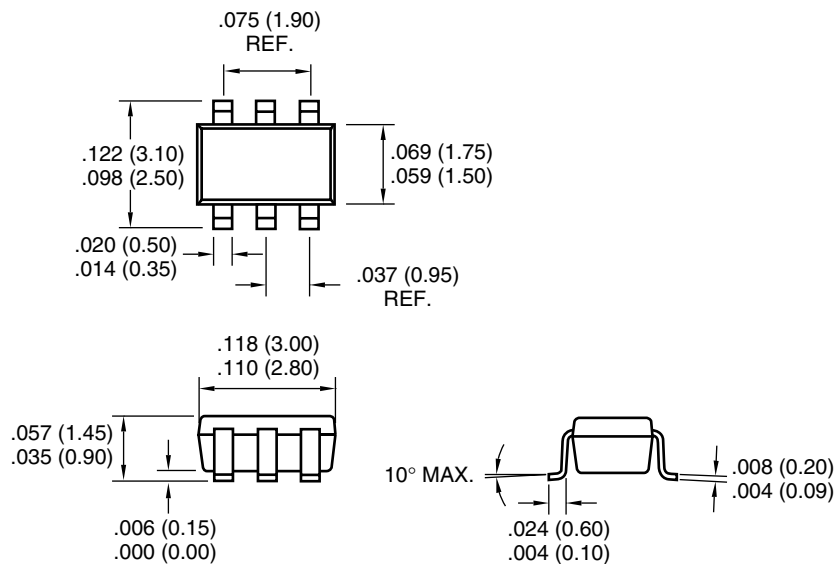

Dimensions: inches (mm)



## SALES AND SUPPORT

### **Data Sheets**

Products supported by a preliminary Data Sheet may have an errata sheet describing minor operational differences and recommended workarounds. To determine if an errata sheet exists for a particular device, please contact one of the following:

1. Your local Microchip sales office
2. The Microchip Corporate Literature Center U.S. FAX: (480) 792-7277
3. The Microchip Worldwide Site ([www.microchip.com](http://www.microchip.com))

Please specify which device, revision of silicon and Data Sheet (include Literature #) you are using.

### **New Customer Notification System**

Register on our web site ([www.microchip.com/cn](http://www.microchip.com/cn)) to receive the most current information on our products.

# TC1072/TC1073

---

NOTES:

Information contained in this publication regarding device applications and the like is intended through suggestion only and may be superseded by updates. It is your responsibility to ensure that your application meets with your specifications. No representation or warranty is given and no liability is assumed by Microchip Technology Incorporated with respect to the accuracy or use of such information, or infringement of patents or other intellectual property rights arising from such use or otherwise. Use of Microchip's products as critical components in life support systems is not authorized except with express written approval by Microchip. No licenses are conveyed, implicitly or otherwise, under any intellectual property rights.

## Trademarks

The Microchip name and logo, the Microchip logo, FilterLab, KEELOQ, microID, MPLAB, PIC, PICmicro, PICMASTER, PICSTART, PRO MATE, SEEVAL and The Embedded Control Solutions Company are registered trademarks of Microchip Technology Incorporated in the U.S.A. and other countries.

dsPIC, ECONOMONITOR, FanSense, FlexROM, fuzzyLAB, In-Circuit Serial Programming, ICSP, ICEPIC, microPort, Migratable Memory, MPASM, MPLIB, MPLINK, MPSIM, MXDEV, MXLAB, PICC, PICDEM, PICDEM.net, rPIC, Select Mode and Total Endurance are trademarks of Microchip Technology Incorporated in the U.S.A.

Serialized Quick Turn Programming (SQTP) is a service mark of Microchip Technology Incorporated in the U.S.A.

All other trademarks mentioned herein are property of their respective companies.

© 2002, Microchip Technology Incorporated, Printed in the U.S.A., All Rights Reserved.

 Printed on recycled paper.

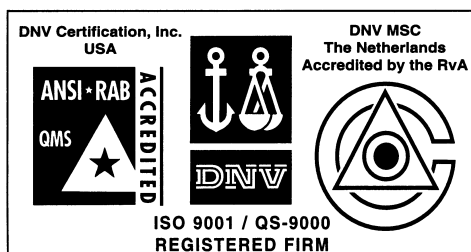

*Microchip received QS-9000 quality system certification for its worldwide headquarters, design and wafer fabrication facilities in Chandler and Tempe, Arizona in July 1999 and Mountain View, California in March 2002. The Company's quality system processes and procedures are QS-9000 compliant for its PICmicro® 8-bit MCUs, KEELOQ® code hopping devices, Serial EEPROMs, microperipherals, non-volatile memory and analog products. In addition, Microchip's quality system for the design and manufacture of development systems is ISO 9001 certified.*



# MICROCHIP

## WORLDWIDE SALES AND SERVICE

### AMERICAS

#### Corporate Office

2355 West Chandler Blvd.  
Chandler, AZ 85224-6199  
Tel: 480-792-7200 Fax: 480-792-7277  
Technical Support: 480-792-7627  
Web Address: <http://www.microchip.com>

#### Rocky Mountain

2355 West Chandler Blvd.  
Chandler, AZ 85224-6199  
Tel: 480-792-7966 Fax: 480-792-7456

#### Atlanta

500 Sugar Mill Road, Suite 200B  
Atlanta, GA 30350  
Tel: 770-640-0034 Fax: 770-640-0307

#### Boston

2 Lan Drive, Suite 120  
Westford, MA 01886  
Tel: 978-692-3848 Fax: 978-692-3821

#### Chicago

333 Pierce Road, Suite 180  
Itasca, IL 60143  
Tel: 630-285-0071 Fax: 630-285-0075

#### Dallas

4570 Westgrove Drive, Suite 160  
Addison, TX 75001  
Tel: 972-818-7423 Fax: 972-818-2924

#### Detroit

Tri-Atria Office Building  
32255 Northwestern Highway, Suite 190  
Farmington Hills, MI 48334  
Tel: 248-538-2250 Fax: 248-538-2260

#### Kokomo

2767 S. Albright Road  
Kokomo, Indiana 46902  
Tel: 765-864-8360 Fax: 765-864-8387

#### Los Angeles

18201 Von Karman, Suite 1090  
Irvine, CA 92612  
Tel: 949-263-1888 Fax: 949-263-1338

#### New York

150 Motor Parkway, Suite 202  
Hauppauge, NY 11788  
Tel: 631-273-5305 Fax: 631-273-5335

#### San Jose

Microchip Technology Inc.  
2107 North First Street, Suite 590  
San Jose, CA 95131  
Tel: 408-436-7950 Fax: 408-436-7955

#### Toronto

6285 Northam Drive, Suite 108  
Mississauga, Ontario L4V 1X5, Canada  
Tel: 905-673-0699 Fax: 905-673-6509

### ASIA/PACIFIC

#### Australia

Microchip Technology Australia Pty Ltd  
Suite 22, 41 Rawson Street  
Epping 2121, NSW  
Australia  
Tel: 61-2-9868-6733 Fax: 61-2-9868-6755

#### China - Beijing

Microchip Technology Consulting (Shanghai)  
Co., Ltd., Beijing Liaison Office  
Unit 915  
Bei Hai Wan Tai Bldg.  
No. 6 Chaoyangmen Beidajie  
Beijing, 100027, No. China  
Tel: 86-10-85282100 Fax: 86-10-85282104

#### China - Chengdu

Microchip Technology Consulting (Shanghai)  
Co., Ltd., Chengdu Liaison Office  
Rm. 2401, 24th Floor,  
Ming Xing Financial Tower  
No. 88 TIDU Street  
Chengdu 610016, China  
Tel: 86-28-86766200 Fax: 86-28-86766599

#### China - Fuzhou

Microchip Technology Consulting (Shanghai)  
Co., Ltd., Fuzhou Liaison Office  
Unit 28F, World Trade Plaza  
No. 71 Wusi Road  
Fuzhou 350001, China  
Tel: 86-591-7503506 Fax: 86-591-7503521

#### China - Shanghai

Microchip Technology Consulting (Shanghai)  
Co., Ltd.  
Room 701, Bldg. B  
Far East International Plaza  
No. 317 Xian Xia Road  
Shanghai, 200051  
Tel: 86-21-6275-5700 Fax: 86-21-6275-5060

#### China - Shenzhen

Microchip Technology Consulting (Shanghai)  
Co., Ltd., Shenzhen Liaison Office  
Rm. 1315, 13/F, Shenzhen Kerry Centre,  
Renminnan Lu  
Shenzhen 518001, China  
Tel: 86-755-2350361 Fax: 86-755-2366086

#### China - Hong Kong SAR

Microchip Technology Hongkong Ltd.  
Unit 901-6, Tower 2, Metroplaza  
223 Hing Fong Road  
Kwai Fong, N.T., Hong Kong  
Tel: 852-2401-1200 Fax: 852-2401-3431

#### India

Microchip Technology Inc.  
India Liaison Office  
Divyasree Chambers  
1 Floor, Wing A (A3/A4)  
No. 11, O'Shaugnessey Road  
Bangalore, 560 025, India  
Tel: 91-80-2290061 Fax: 91-80-2290062

### Japan

Microchip Technology Japan K.K.  
Benex S-1 6F  
3-18-20, Shinyokohama  
Kohoku-Ku, Yokohama-shi  
Kanagawa, 222-0033, Japan  
Tel: 81-45-471-6166 Fax: 81-45-471-6122

### Korea

Microchip Technology Korea  
168-1, Youngbo Bldg. 3 Floor  
Samsung-Dong, Kangnam-Ku  
Seoul, Korea 135-882  
Tel: 82-2-554-7200 Fax: 82-2-558-5934

### Singapore

Microchip Technology Singapore Pte Ltd.  
200 Middle Road  
#07-02 Prime Centre  
Singapore, 188980  
Tel: 65-6334-8870 Fax: 65-6334-8850

### Taiwan

Microchip Technology Taiwan  
11F-3, No. 207  
Tung Hua North Road  
Taipei, 105, Taiwan  
Tel: 886-2-2717-7175 Fax: 886-2-2545-0139

### EUROPE

#### Denmark

Microchip Technology Nordic ApS  
Regus Business Centre  
Lautrup høj 1-3  
Ballerup DK-2750 Denmark  
Tel: 45 4420 9895 Fax: 45 4420 9910

#### France

Microchip Technology SARL  
Parc d'Activite du Moulin de Massy  
43 Rue du Saule Trapu  
Batiment A - 1er Etage  
91300 Massy, France  
Tel: 33-1-69-53-63-20 Fax: 33-1-69-30-90-79

#### Germany

Microchip Technology GmbH  
Gustav-Heinemann Ring 125  
D-81739 Munich, Germany  
Tel: 49-89-627-144 0 Fax: 49-89-627-144-44

#### Italy

Microchip Technology SRL  
Centro Direzionale Colleoni  
Palazzo Taurus 1 V. Le Colleoni 1  
20041 Agrate Brianza  
Milan, Italy  
Tel: 39-039-65791-1 Fax: 39-039-6899883

#### United Kingdom

Microchip Ltd.  
505 Eskdale Road  
Winnersh Triangle  
Wokingham  
Berkshire, England RG41 5TU  
Tel: 44 118 921 5869 Fax: 44-118 921-5820

05/01/02

