

TOSHIBA RF POWER AMPLIFIER MODULE

S-AU83AH

FM RF POWER AMPLIFIER MODULE FOR 32-W COMMERCIAL UHF RADIO APPLICATIONS

- Power Gain: 28 dB (Min.)
- Total Efficiency: 40% (Min.)

ABSOLUTE MAXIMUM RATINGS (Tc = 25°C, I_T < 10 A, Z_G = Z_L = 50Ω)

CHARACTERISTICS	SYMBOL	TEST CONDITION	RATING	UNIT
Maximum Current	I _T		10	A
Power Supply Voltage	V _{DD}	V _{GG} = 0 V (GND), RF: none	16.5	V
Control Voltage	V _{GG}	10.5 ≤ V _{DD} ≤ 16.5 V, P _i = 50 mW	5.5	V
Instantaneous Output Power	P _{omax}	V _{GG} ≤ 5.5 V, P _i = 50 mW, 10.5 ≤ V _{DD} ≤ 16.5V, within 2 seconds	40	W
Input Power	P _i	10.5 ≤ V _{DD} ≤ 16.5 V, V _{GG} ≤ 5.5 V	100	mW
Operating Case Temperature	T _{c (opr)}	10.5 ≤ V _{DD} ≤ 16.5 V, V _{GG} ≤ 5.5 V, P _i = 50 mW (Note 2)	-30 to 100	°C
Storage Temperature	T _{stg}		-40 to 110	°C

Note 1: The maximum ratings are the limits that must not be exceeded even for an instant, under worst possible conditions. Exceeding the ratings may cause device damage, ignition, or deterioration. Therefore, when designing the circuitry, derating factors should be applied so that the absolute maximum ratings are not exceeded.

Note 2: The output power rating satisfies the range shown in Figures 1 and 2 according to the operating case temperature. Ensure that the device should be operated within the specified operating range. The figures below indicate the output power obtained 2 seconds after P_o is generated.

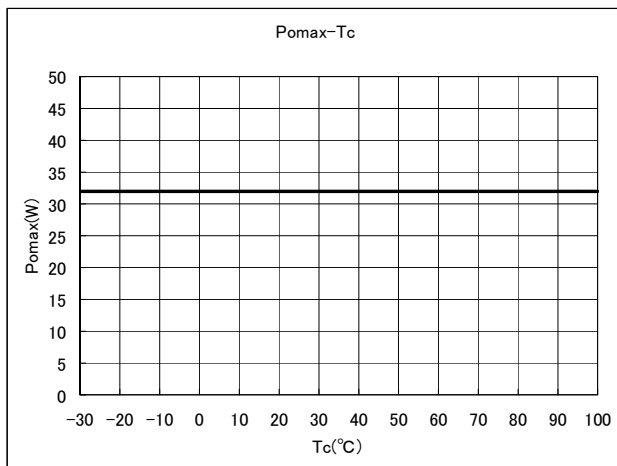

Figure 1 Pomax-Tc

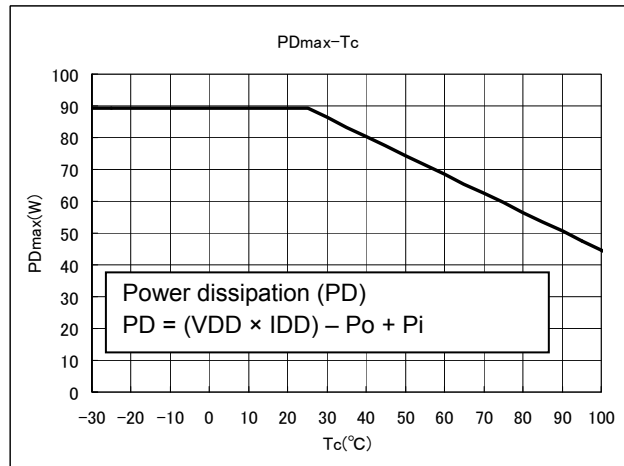

Figure 2 PDmax-Tc

*When the device is used at T_c = 100°C, the output power rating is 32 W as shown in Figure 1. When the power dissipation at T_c = 100°C exceeds the rating shown in Figure 2, the output derating is required to limit the dissipation within the specified range.

Note 3: The case temperature is monitored using the screw terminal blocks on the input side that are used for the module implementation.

Note 4: To protect a device from being permanently damaged, the power-on sequence must be as follows (, while the reversed order should be applied when turning off): 1. V_{DD}, 2. P_i, 3. V_{GG}

PACKAGE OUTLINE

Unit: mm

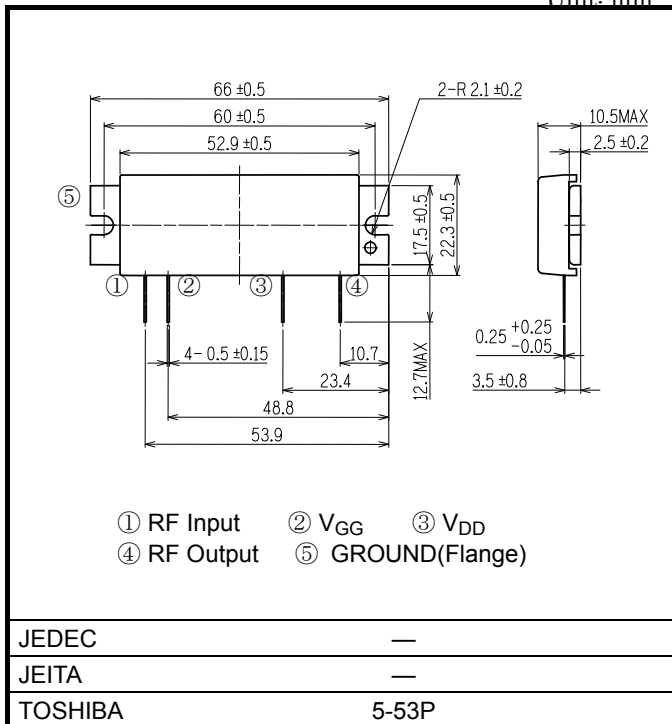

Weight: 35 g

ELECTRICAL CHARACTERISTICS (T_c = 25°C, Z_G = 50Ω)

CHARACTERISTICS	SYMBOL	TEST CONDITION	MIN	TYP.	MAX	UNIT
Frequency Range	f _{range}	—	450	—	520	MHz
Output Power	P _o	V _{DD} = 12.5 V V _{GG} = 5 V P _i = 50 mW Z _L = 50 Ω	32	—	—	W
Power Gain	G _p		28	—	—	dB
Total Efficiency	η _T		40	—	—	%
Input VSWR	VSWR _{in}		—	—	3.0	—
Second Harmonic	2nd HRM		—	—	-30	dB
Third Harmonic	3rd HRM		—	—	-30	dB
Ruggedness	—		10.5 V ≤ V _{DD} ≤ 16.5 V, 0 V ≤ V _{GG} ≤ V _{GGaj} s (V _{GG} = V _{GGaj} s @ P _o = 32 W) P _i = 50 mW P _o = 32 W (Adjusted via V _{GG} @ Z _L = 50Ω) VSWR LOAD 20: 1 ALL PHASE (@ 2 s)	No Damage		
Stability	—	10.5 V ≤ V _{DD} ≤ 16.5 V, 0 V ≤ V _{GG} ≤ V _{GGaj} s (V _{GG} = V _{GGaj} s @ P _o = 32W) P _i = 50 mW P _o ≤ 32 W (Adjusted via V _{GG} @ Z _L = 50Ω) VSWR LOAD 3: 1 ALL PHASE	No spurious output of -60 dB or greater			—

Note 5: The output power is intended to follow the rating provided in Figure 1 in Note 2.

Note 6: Stability

Measurements are performed under the conditions where VSWR is at 3:1 through all phases over the whole frequency range, and they are guaranteed only under those conditions. Even though it is guaranteed to be stable where VSWR is at 3:1, the VSWR load over the operating frequency should be designed to be 50 Ω. At the same time, ensure that the VSWR load does not deviate much from 50Ω even for a moment, nor deviate even a little from 50Ω continually. The S-AU82AL is not intended for such operations, and proper operation under such conditions is not guaranteed due to the possibilities of heat generation in the module and its applications.

HANDLING PRECAUTIONS

- Since this product has a protective cap, care should be taken to avoid applying an excessive impact and allowing foreign objects to get inside when handling this product. Also, please do not remove a cap. If the cap is removed, the foreign object inside the module or the applied impact may lead IC failure, causing smoke or ignition.
- Since this product is structurally susceptible to static electricity, protections against the static electricity should be applied to objects that may come in direct contact with devices, such as worktables, equipment, operators and solder irons.
- This product is not designed nor intended to perform a continuous transmission for applications like a base station. Please do not use this product for such applications, for the reliability cannot be guaranteed.
- This product is intended to be used for a single operation (single-device operation). A proper operation is not guaranteed for a parallel operation. A parallel operation should be performed in accordance with your own good judgment.
- Mounting method
 - The flatness of a heat sink must not exceed 50 μm . If the flatness exceeds 50 μm , the device may experience an unexpected stress that may lead to module breakdown due to damage or ignition in the substrate inside a module and other module parts.
 - Please apply thermal compound between a module and a heat sink to improve the adhesive property.
 - Use a 4-mm diameter screw with the clamping screw torque of 1.2 to 1.5 Nm.
 - Please solder the module leads after the screw is clamped.

EQUIVALENT CIRCUIT

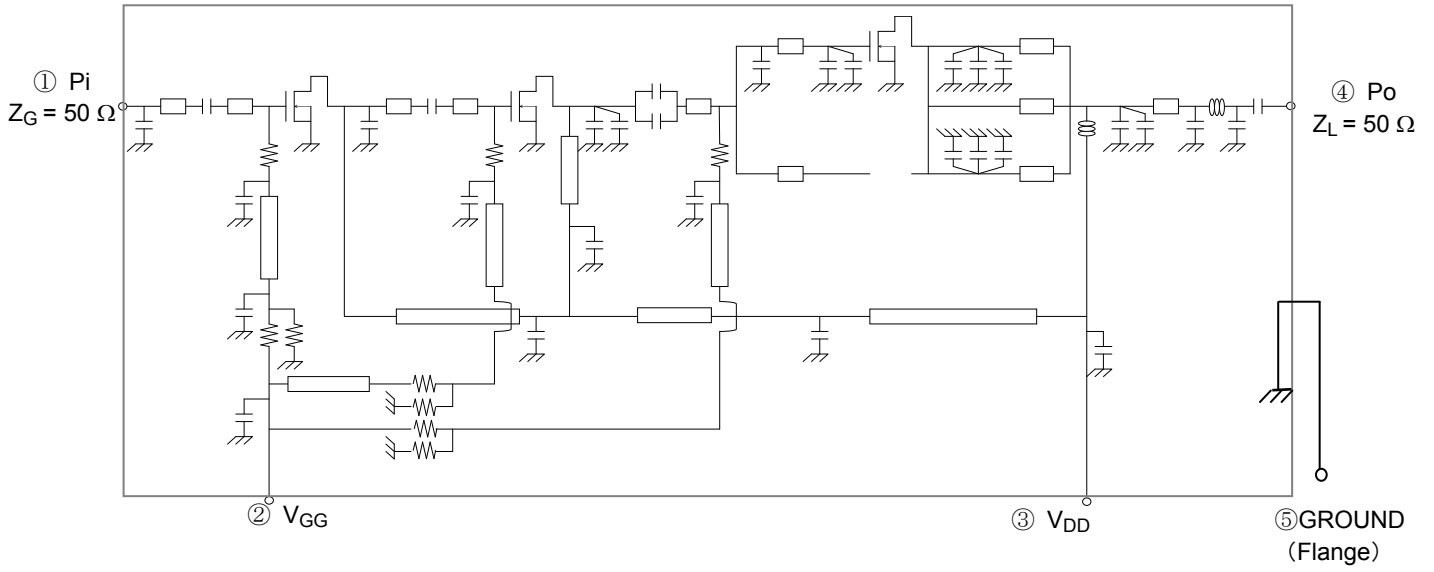

TEST FIXTURE

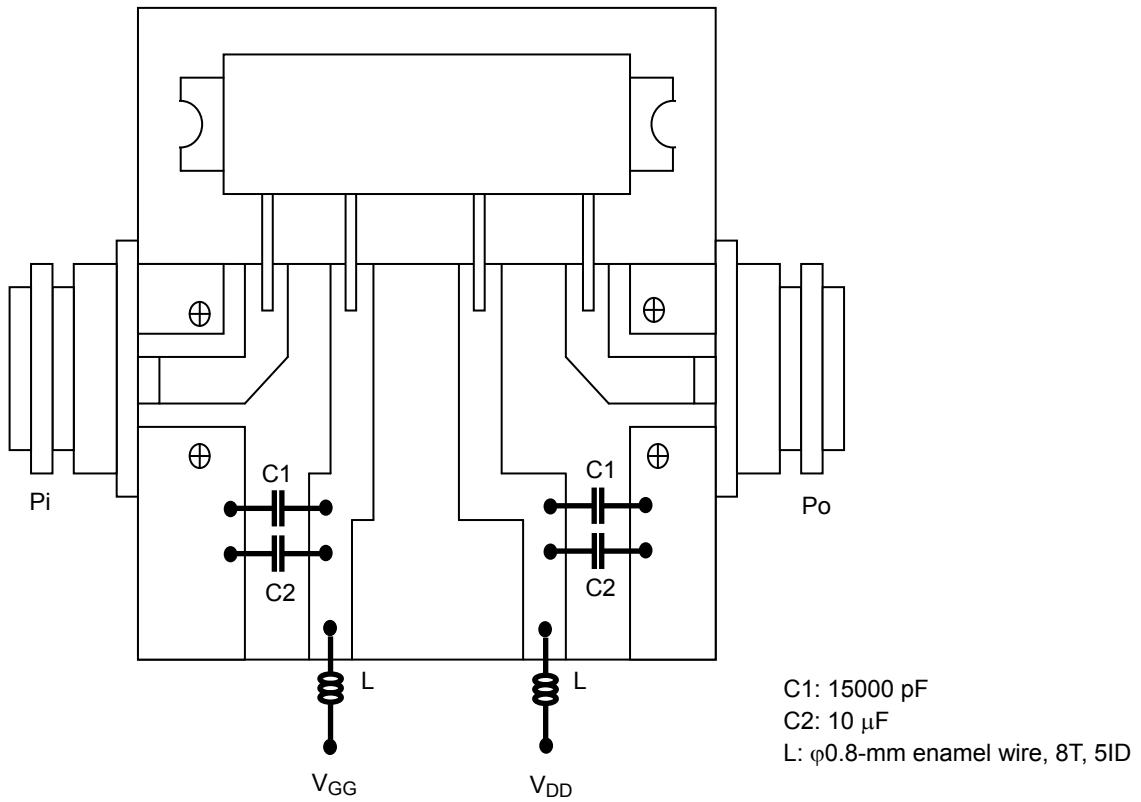

MARKING

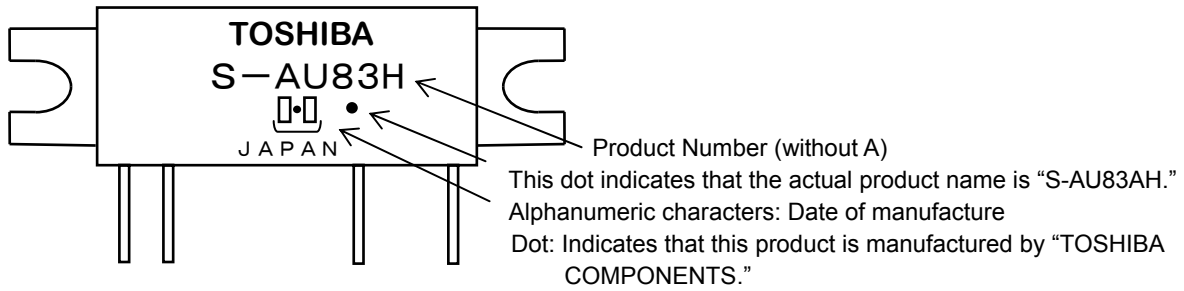

Explanation of Lot No.

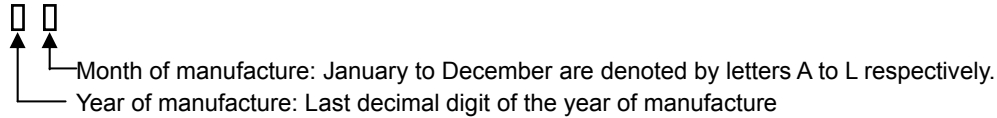

RESTRICTIONS ON PRODUCT USE

20070701-EN

- The information contained herein is subject to change without notice.
- TOSHIBA is continually working to improve the quality and reliability of its products. Nevertheless, semiconductor devices in general can malfunction or fail due to their inherent electrical sensitivity and vulnerability to physical stress. It is the responsibility of the buyer, when utilizing TOSHIBA products, to comply with the standards of safety in making a safe design for the entire system, and to avoid situations in which a malfunction or failure of such TOSHIBA products could cause loss of human life, bodily injury or damage to property.
In developing your designs, please ensure that TOSHIBA products are used within specified operating ranges as set forth in the most recent TOSHIBA products specifications. Also, please keep in mind the precautions and conditions set forth in the "Handling Guide for Semiconductor Devices," or "TOSHIBA Semiconductor Reliability Handbook" etc.
- The TOSHIBA products listed in this document are intended for usage in general electronics applications (computer, personal equipment, office equipment, measuring equipment, industrial robotics, domestic appliances, etc.). These TOSHIBA products are neither intended nor warranted for usage in equipment that requires extraordinarily high quality and/or reliability or a malfunction or failure of which may cause loss of human life or bodily injury ("Unintended Usage"). Unintended Usage include atomic energy control instruments, airplane or spaceship instruments, transportation instruments, traffic signal instruments, combustion control instruments, medical instruments, all types of safety devices, etc.. Unintended Usage of TOSHIBA products listed in this document shall be made at the customer's own risk.
- The products described in this document shall not be used or embedded to any downstream products of which manufacture, use and/or sale are prohibited under any applicable laws and regulations.
- The information contained herein is presented only as a guide for the applications of our products. No responsibility is assumed by TOSHIBA for any infringements of patents or other rights of the third parties which may result from its use. No license is granted by implication or otherwise under any patents or other rights of TOSHIBA or the third parties.
- Please contact your sales representative for product-by-product details in this document regarding RoHS compatibility. Please use these products in this document in compliance with all applicable laws and regulations that regulate the inclusion or use of controlled substances. Toshiba assumes no liability for damage or losses occurring as a result of noncompliance with applicable laws and regulations.