

# TC7PB53TU

## Single 1-of-2 Demultiplexer with N-channel pull-down MOSFET

The TC7PB53TU is a single 1-of-2 high-speed CMOS demultiplexer designed for low-voltage applications. The low ON-resistance of the switch allows the input (COM) to be connected to the outputs (Ch0 and Ch1) while maintaining CMOS low power dissipation. The device uses P-channel MOSFETs for the switch block between the input and output pins.

When the control input (A) is Low, the data (High-level) in the COM pin is routed to the Ch0 pin. When the control input (A) is High, the data (High-level) in the COM pin is routed to the Ch1 pin. The unused pin is clamped to ground using an N-channel MOSFET.

All inputs are equipped with protection circuits against static discharge.

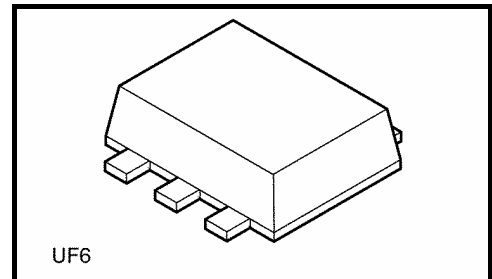

Weight: 0.007g (typ.)

### Features

- Operating voltage range :  $V_{CC} = 2$  to  $3.6$  V
- High-speed operation :  $t_{pd} = 50$  ns (max) @  $2.7$  V
- Very low ON-resistance :  $R_{ON} = 3\Omega$  (max) @  $2.7$  V
- High latch-up immunity :  $\pm 300$  mA
- ESD performance : Machine model  $\geq \pm 200$  V  
Human body model  $\geq \pm 2000$  V
- Package : UF6

### Pin Assignment (top view)

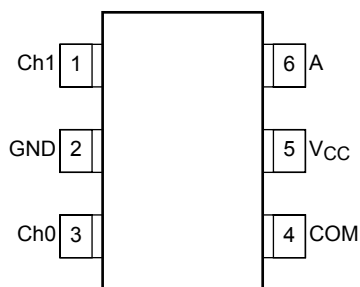

### Marking

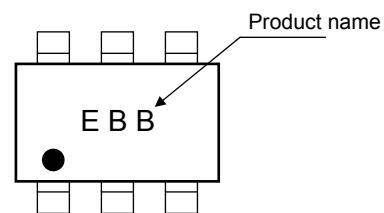

## Truth Table

Input	Function	
	Ch0	Ch1
L	COM	L
H	L	COM

## Logic Diagram

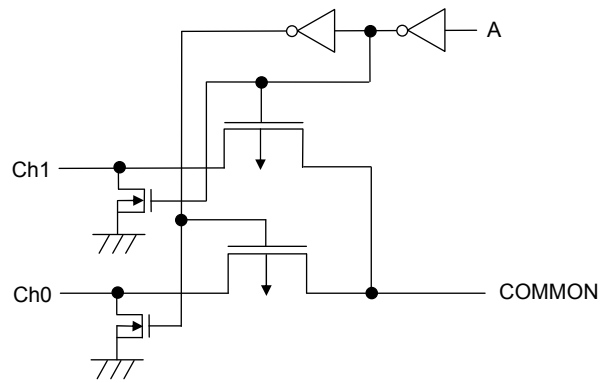

## Absolute Maximum Ratings (Note 1)

Characteristics	Symbol	Rating	Unit
Power supply voltage	$V_{CC}$	-0.5 to 4.6	V
DC input voltage (A)	$V_{IN}$	-0.5 to 4.6	V
DC switch voltage (COM and Ch)	$V_S$	-0.5 to $V_{CC} + 0.5$	V
Input diode current (A)	$I_{IK}$	-25	mA
Output diode current (COM and Ch)		$\pm 25$	mA
Switch I/O current (COM to Ch)	$I_S$	128	mA
N-channel MOSFET current (Note 2)	$I_{OUT}$	25	mA
Power dissipation	$P_D$	200	mW
DC $V_{CC}$ /ground current	$I_{CC}/I_{GND}$	$\pm 50$	mA
Storage temperature	$T_{stg}$	-65 to 150	$^{\circ}C$

Note 1: Exceeding any of the absolute maximum ratings, even briefly, may lead to deterioration in IC performance or even destruction.

Using continuously under heavy loads (e.g. the application of high temperature/current/voltage and the significant change in temperature, etc.) may cause this product to decrease in the reliability significantly even if the operating conditions (i.e. operating temperature/current/voltage, etc.) are within the absolute maximum ratings and the operating ranges.

Please design the appropriate reliability upon reviewing the Toshiba Semiconductor Reliability Handbook ("Handling Precautions"/"Derating Concept and Methods") and individual reliability data (i.e. reliability test report and estimated failure rate, etc).

Note 2: N-channel MOSFET allowable current to clamp the unused pin to ground.

## Operating Ranges (Note)

Characteristics	Symbol	Value	Unit
Power supply voltage	$V_{CC}$	2.0 to 3.6	V
Input voltage (A)	$V_{IN}$	0 to 3.6	V
DC switch voltage (COM and Ch)	$V_S$	0 to $V_{CC} + 0.3$	V
Operating temperature	$T_{opr}$	-40 to 85	$^{\circ}C$
Input rise and fall time	$d_t/d_v$	0 to 10	ns/V

Note: The operating ranges must be maintained to ensure the normal operation of the device. Unused inputs must be tied to either  $V_{CC}$  or GND.

## Electrical Characteristics

### DC Electrical Characteristics (Ta = -40~85°C)

Characteristics	Symbol	Test Condition	V <sub>CC</sub> (V)	Min	Typ.	Max	Unit
High-level input voltage	V <sub>IH</sub>	—	2.0 to 3.6	0.7 × V <sub>CC</sub>	—	—	V
Low-level input voltage	V <sub>IL</sub>	—	2.0 to 3.6	—	—	0.3 × V <sub>CC</sub>	
Input leakage current (A)	I <sub>IN</sub>	A = 0 to 3.6 V	2.0 to 3.6	—	—	±1.0	μA
Off-state leakage current	I <sub>IZ</sub>	COM, Ch = 0 to V <sub>CC</sub>	2.0 to 3.6	—	—	±1.0	μA
Output diode current (COM and Ch) (Note 1)	I <sub>IK</sub>	COM, Ch = V <sub>CC</sub> to V <sub>CC</sub> + 0.3	2.0 to 3.6	—	—	100	μA
Switch ON resistance (Note 2)	R <sub>ON</sub>	V <sub>IS</sub> = 3.0 V, I <sub>IS</sub> = 3 mA	3.0	—	1.6	3	Ω
		V <sub>IS</sub> = 2.7V, I <sub>IS</sub> = 3 mA	2.7	—	1.7	3	
		V <sub>IS</sub> = 2.3 V, I <sub>IS</sub> = 3 mA	2.3	—	2.1	5	
		V <sub>IS</sub> = 3.0 V, I <sub>IS</sub> = 30 mA	3.0	—	1.6	3	
		V <sub>IS</sub> = 2.7V, I <sub>IS</sub> = 30 mA	2.7	—	1.7	3	
		V <sub>IS</sub> = 2.3 V, I <sub>IS</sub> = 30 mA	2.3	—	2.1	5	
N-ch MOSFET ON resistance	R <sub>ON</sub> (Nch)	I <sub>OL</sub> = 5 mA, V <sub>IN</sub> = 0 V	2.7	—	—	50	Ω
		I <sub>OL</sub> = 4 mA, V <sub>IN</sub> = 0 V	2.3	—	—	75	
Increase in I <sub>CC</sub> per Input	I <sub>CC</sub>	V <sub>IN</sub> = V <sub>CC</sub> or GND,	3.6	—	—	10	μA

Note 1: Output diode current at the COM pin measured with the Ch pin open.  
Output diode current at the Ch pin measured with the COM pin open. .

Note 2: Measured by the voltage drop between the COM and Ch pins at the indicated current through the switch.  
On resistance is determined by the lower of the voltages on the two (COM or Ch) pins.

### AC Electrical Characteristics (Ta = -40~85°C)

Characteristics	Symbol	Test Condition	V <sub>CC</sub> (V)	Min	Max	Unit
Propagation delay time (A to Ch)	t <sub>pLH</sub>	(Figures 1 and 2)	3.0 ± 0.3	—	50	ns
	t <sub>pHL</sub>		2.5 ± 0.2	—	65	

### Capacitive Characteristics (Ta = 25°C)

Characteristics	Symbol	Test Condition	V <sub>CC</sub> (V)	Typ.	Unit
Control input capacitance (A)	C <sub>IN</sub>	(Note)	3.0	5	pF
COM-Ch I/O capacitance	C <sub>I/O</sub>	(Note)	3.0	50	pF

Note: Capacitance quoted is not tested.

$R_{ON}$ - $V_{IN}$  Characteristic Curves  $V_{CC} = 2.7 V$ ,  $I_{is} = 3 mA$ ,  $T_a = -40/25/85^{\circ}C$

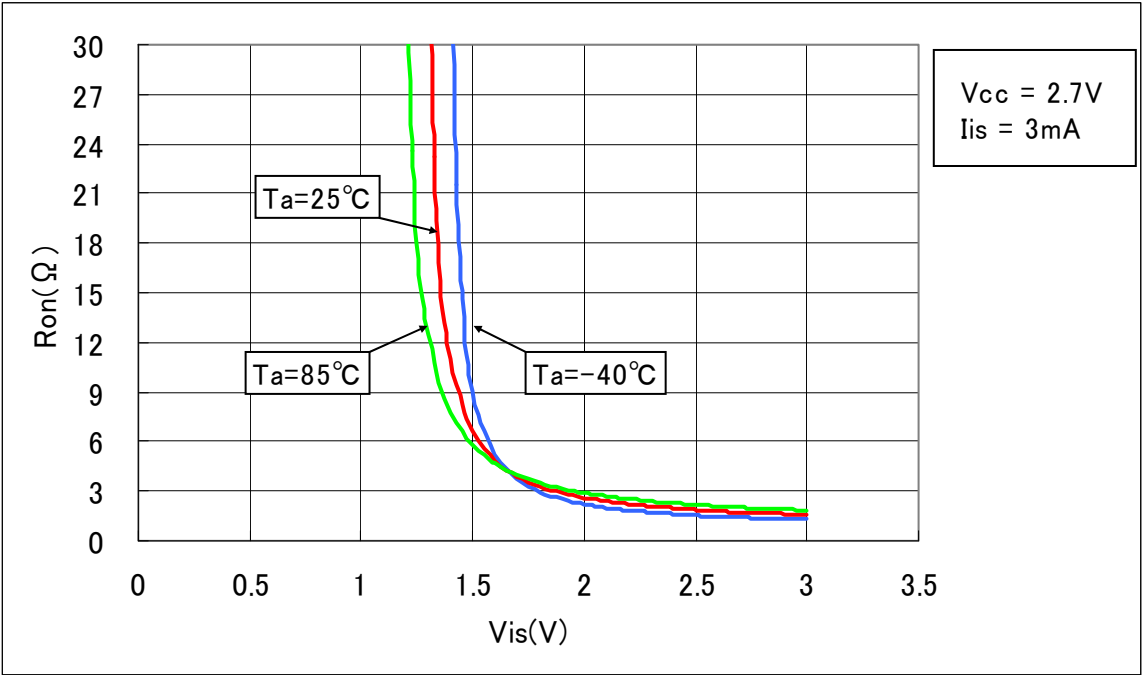

**AC Test Circuit**

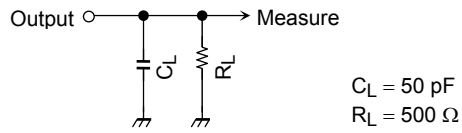

**Figure 1**

**AC Waveforms**

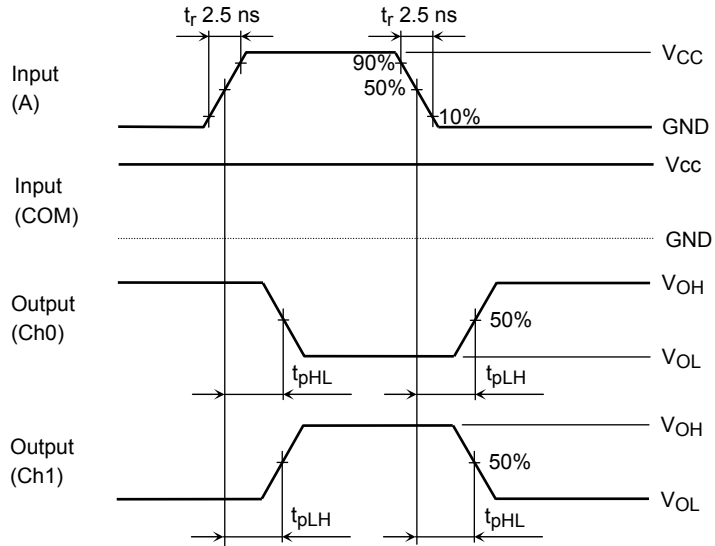
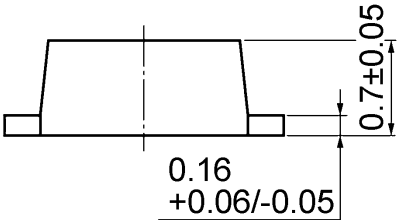
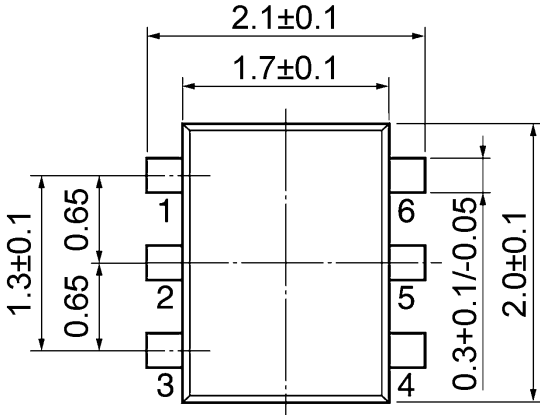

**Figure 2  $t_{pLH}$   $t_{pHL}$**

**Package Dimensions**

UF6

Unit:mm



Weight: 0.007 g (typ.)

**RESTRICTIONS ON PRODUCT USE**

20070701-EN GENERAL

- The information contained herein is subject to change without notice.
- TOSHIBA is continually working to improve the quality and reliability of its products. Nevertheless, semiconductor devices in general can malfunction or fail due to their inherent electrical sensitivity and vulnerability to physical stress. It is the responsibility of the buyer, when utilizing TOSHIBA products, to comply with the standards of safety in making a safe design for the entire system, and to avoid situations in which a malfunction or failure of such TOSHIBA products could cause loss of human life, bodily injury or damage to property.  
In developing your designs, please ensure that TOSHIBA products are used within specified operating ranges as set forth in the most recent TOSHIBA products specifications. Also, please keep in mind the precautions and conditions set forth in the "Handling Guide for Semiconductor Devices," or "TOSHIBA Semiconductor Reliability Handbook" etc.
- The TOSHIBA products listed in this document are intended for usage in general electronics applications (computer, personal equipment, office equipment, measuring equipment, industrial robotics, domestic appliances, etc.). These TOSHIBA products are neither intended nor warranted for usage in equipment that requires extraordinarily high quality and/or reliability or a malfunction or failure of which may cause loss of human life or bodily injury ("Unintended Usage"). Unintended Usage include atomic energy control instruments, airplane or spaceship instruments, transportation instruments, traffic signal instruments, combustion control instruments, medical instruments, all types of safety devices, etc.. Unintended Usage of TOSHIBA products listed in this document shall be made at the customer's own risk.
- The products described in this document shall not be used or embedded to any downstream products of which manufacture, use and/or sale are prohibited under any applicable laws and regulations.
- The information contained herein is presented only as a guide for the applications of our products. No responsibility is assumed by TOSHIBA for any infringements of patents or other rights of the third parties which may result from its use. No license is granted by implication or otherwise under any patents or other rights of TOSHIBA or the third parties.
- Please contact your sales representative for product-by-product details in this document regarding RoHS compatibility. Please use these products in this document in compliance with all applicable laws and regulations that regulate the inclusion or use of controlled substances. Toshiba assumes no liability for damage or losses occurring as a result of noncompliance with applicable laws and regulations.